

Design and calculation aids, applications, diagrams

Designing with E-Chains® ► from page 1.1

1



Multi-axis E-Chains® for robotic or 3D movements

Triflex® R, Triflex®, TwisterChain® ► from page 2.1

2



Low-priced, easy to fill E-Chains®

Easy Chain®, System E1, SnapChain ► from page 3.1

3



Zip-open, easy to fill E-Chains® and E-Tubes

Zipper E-Chains® and E-Tubes ► from page 4.1

4



Allrounder E-Chains® and E-Tubes, snap-open*, micro, mini, medium sizes

E2 micro, mini, E2/000 medium ► from page 5.1 *enclosed series from page 5.86

5



Dirt- and debris protection, snap-open E-Tubes

E2 E-Tubes: Serie R, R100 and RX ► from page 6.1

6



Universal E4 modular kit, E-Chains® and E-Tubes for all applications

System E4 - Series E4.1, E4/light, E4/00, E4/4 ► from page 7.1

7



Cleanroom E-Chains® and E-Tubes, low noise, low vibration

System E3, T3, E6 ► from page 8.1

8



Guide troughs and special solutions for long travel applications

System P4, Rol E-Chain®, AUTO-GLIDE, Guidelok, Flizz® ► from page 9.1

9



Strain relief... clamps, tiwrap plates, clips etc.

Chainfix strain relief ► from page 10.1

10



Cable protection

PMA conduits ► from page 11.1

11



Older products, about igus®, terminology index, igus® addresses

Classic-series, technical annex ► from page 12.1

12

Products

Robotic- and 3D E-Chains®, circular movements

Robotics applications Triflex® RB closed design	Robotics applications Triflex® RB "Easy" design	Non robotic applications Triflex® RB light design
---	---	---



New accessories, new size!



TRC: closed design, smooth and robust exterior
▶ page 2.12



New accessories, new size!



TRE: "easy" Design, easily to be filled 3D E-Chain®
▶ page 2.14



New accessories!



TRL: light weight and cost-efficient 3D E-Chain®
▶ page 2.16

More attractive, easy to fill E-Chains®

Simply press cables in Easy Chain® Version E	Simply press cables in Easy Chain® Version Z	E-Chain® on one strip System E1
--	--	---

Also available as ESD version!



Split crossbar along the outer radius. Some series available with multiple chamber system ▶ from page 3.4

Also available as ESD version!



Split crossbar along the inner radius. Some series available with multiple chamber system ▶ from page 3.4



Snap-open lids along the outer radius, very easy to fill
▶ from page 3.64

Smallest E-Chains®

Smallest sizes - one-piece
E2 micro | Non snap-open



Non snap-open. Smallest inner heights and bending radii.
▶ from page 5.8

Small E-Chains®

Smallest sizes - two-piece
E2 micro | Snap-open



Snap-open along outer radius with film-hinge
▶ from page 5.30 / 5.38

Small sizes - one-piece
E2 mini | Non snap-open



Non snap-open. Large pins and double stop dog system
▶ from page 5.48

3D applications
Easy Triflex® | Simple filling



Easy Triflex®: "easy" Design, easily to be filled
 13-38,5
 13-38,5
 ▶ page 2.36

3D applications
Triflex® | Closed version



Triflex®: protection against dirt and chips, combined circle- and stroke-movements
 16-75
 ▶ page 2.48

Circular movements
TwisterChain® | Snap-open



New guide trough system!
 Crossbars can be opened on both sides, circular motions up to 60°
 28-56
 ▶ page 2.62

Loop - E-Chains®
SnapChain



Adjustable loops, to be opened along the outer radius. 2 sizes available
 50-120
 ▶ from page 3.68

Fast assembly with zipper
Zipper | E-Chains®



Zip-open along outer radius, fast assembly
 9-32
 ▶ from page 4.4

Fast assembly with zipper
Zipper | E-Tubes



Zip-open along outer radius, fast assembly
 10,3-32
 ▶ from page 4.28

Small sizes - two-piece
E2 mini | Snap-open



New version!
 Snap-open along inner radius, double stop dog system
 20-32
 ▶ from page 5.66

Small sizes - two-piece
E2 mini | Snap-open



Snap-open along outer radius, double stop dog system
 17-32
 ▶ Seite 5.70

Allrounder E-Chains®/E-Tubes

Medium sizes - **E-Chain®** - two-piece
E2/000 | Snap-open



Snap-open along inner radius. High stability, quiet motion
 21-45
 ▶ from page 5.90

Products

Allrounder E-Chains®/E-Tubes (Continuation of page 3)

Medium sizes - **E-Chain®** - two-piece
E2/000 | Snap-open

Medium sizes - **half E-tube** - two-piece
E2/000 | Snap-open

Medium sizes - **E-Tube** - two-piece
E2/000 | Snap-open



New sizes!



New sizes!



Snap-open along outer radius.
High stability, quiet motion
▶ from page 5.90



Snap-open along inner radius.
High stability, quiet motion
▶ from page 5.90



Snap-open along inner radius.
High stability, quiet motion
▶ from page 5.90

E4.1 - Universal E4 modular kit, E-Chains®/E-Tubes for almost all applications

Standard - 4-piece, snap-open
E4.1 | Crossbars every link

Standard - 4-piece, snap-open
E4.1 | Crossbars every 2nd link

Standard - 4-piece - hinged, removable lids
E4.1 | E-Tubes, fully enclosed

New, optimized interior separation kit for E4.1, new accessories!



New sizes!



Long travels, large unsupported lengths, snap-open along both radii ▶ from page 7.14



Long travels, large unsupported lengths, snap-open along both radii ▶ from page 7.14

New widths!



Long travels, large unsupported lengths, snap-open along both radii ▶ from page 7.14

E4/00 - For new designs we recommend E4.1!

4-piece, snap-open along both radii
E4/00 | Crossbars every link

4-piece, snap-open along both radii
E4/00 | Crossbars every 2nd link

Standard - 4-piece - hinged, removable lids
E4/00 | E-Tubes, fully enclosed



The E4.1 predecessor for smooth motion and easy assembly
▶ from page 7.160



The E4.1 predecessor for smooth motion and easy assembly
▶ from page 7.160



The E4.1 predecessor for smooth motion and easy assembly
▶ from page 7.160

Protection against dirt and chips, snap-open E-Tubes

Snap-open along both radii
E2 E-Tubes | R100



 21-50 Snap-open on both sides.
Excellent chip protection
▶ from page 6.4

Snap-open along outer radius
E2 E-Tubes | R



 25-45 Removable lids along outer
radius. Small pitch for smooth
operation ▶ from page 6.4

Snap-open along outer radius
RX E-Tubes | RX40



World premiere!

 52 Full chip protection without under-
cuts, projecting edges and gaps
▶ from page 6.54

E4/light - Low weight, economic and stable

4-piece, snap-open
E4/light | Crossbars every link



 56-80 Light and stable. Inner-/outer-link
design - Save weight and money!
▶ from page 7.122

4-piece, snap-open
E4/light | Crossbars every 2nd link



 56-80 Light and stable. Inner-/outer-link
design - Save weight and money!
▶ from page 7.122

4-piece - hinged, removable lids
E4/light | E-Tubes, fully enclosed



 56-80 Light and stable. Inner-/outer-link
design - Save weight and money!
▶ from page 7.122

E4/4 - For new designs we recommend E4.1!

4-piece, snap-open along both radii
E4/4 | Crossbars every link



 32-80 The E4.1 predecessor for long travel
and side-mounted applications
▶ from page 7.222

4-piece, snap-open along both radii
E4/4 | Crossbars every 2nd link



 32-80 The E4.1 predecessor for long travel
and side-mounted applications
▶ from page 7.222

4-piece - hinged, removable lids
E4/4 | E-Tubes, fully enclosed



 32-80 The E4.1 predecessor for long travel
and side-mounted applications
▶ from page 7.222

Products

Cleanroom E-Chains® - low noise, low vibration

Superquiet in small spaces
E3 | E-Chains®

For highly dynamic applications, low-noise
T3 | E-Chains® - Band

Low vibration, for cleanroom applications
E6 | E-Chains®

New widths, new radii

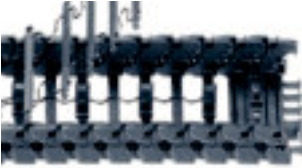

Snap-open along outer radius.
Fast assembly - crossbars "on a string" ► from page 8.8



Snap-open along outer radius.
Low-price for simple applications
► from page 8.26



No pin/bore connections, minimal abrasion, snap-open along both radii ► from page 8.38

Stable and rugged for heavy duty applications
Steel guide troughs

Lets light and dirt through
Tubular troughs | System RS

Low price, easy assembly
Snap-in troughs | System SP

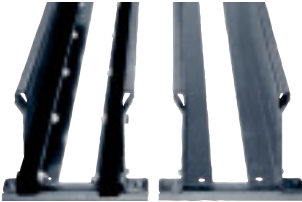

For special applications in rough environments. Huge product range ► from page 9.42

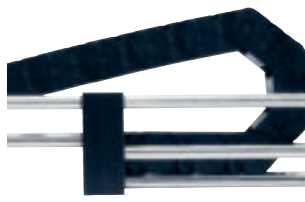

Resistant to dirt.
Easy assembly and low price
► from page 9.66



Very small trough.
Easy assembly and low price
► from page 9.68

Long travels without guide troughs
AUTO-GLIDE

Upper run guide, unsupported travels 50m
Guidelok | horizontal

Secure vertical guidance up to 80 m
Guidelok | vertical

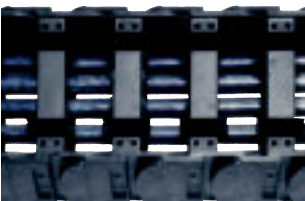

Self-guiding E-ChainSystem®.
No guide troughs required
► from page 9.90



New in this catalog!

Upper run guide for long travels, unsupported in critical chip areas
► from page 9.96



Simple, costeffective solution for vertical applications with lateral motion
► from page 9.98

Guide Troughs - secure guide on long travels

Superquiet, low vibration, cleanroom
E6 | E-Tubes, removable lids

Basic version - for general machinery
Aluminium "SuperTrough"

Heavy-duty version - for rugged plant construction
Aluminium "SuperTrough"



 29-52 No pin/bore connections, minimal abrasion, snap-open along both radii ▶ from page 8.38



 77-236 The igus® standard guide trough. Very simple, modular assembly ▶ from page 9.12



 87-236 Recommended for plant construction ▶ from page 9.12

Support of the lower run

Support tray tool kit
Support tray

New in this catalog!



Support tray tool kit for support of the lower run, price-saving
▶ page 9.70

Special solutions - long travels without guide troughs

Energy efficiency system for long travels
System P4 | Rol E-Chain®

Rolling instead of gliding
Rol E-Chain®

New size!



 32-80 Secure, virtually maintenance-free energy supply for long travels up to 800 m ▶ from page 9.78



 32-80 Reduction in drive power to less than 25 % for moving the E-Chain® ▶ from page 9.86

Enclosed plastic trough
LBT Flizz®



 24 High speeds and accelerations, price-saving
▶ from page 9.100

Small E-Chains® in aluminum profile
Micro Flizz®



 11-13 Master long travels with the smallest E-Chains® without failures
▶ from page 9.104

Magnetic, floating, gliding
LeviChain



 22,5 Magnetic, "floating" E-ChainSystem®
▶ from page 9.112

Products

Project (Continuation of page 7)

Fast project planning, completely from stock
Modular system for projects

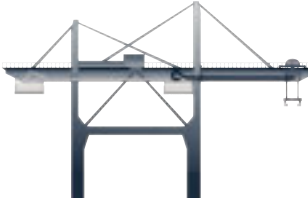

Faster quotations,
 faster project planning
 ► from page 9.116

Chainfix strain relief

For maximum pull forces, adjustable
Clamps | Galvanized or stainless steel

New version!



Single, double and triple clamp housing incl. top/bottom and stacker saddle clamps. Galvanized or stainless steel (Material 1.4301)
 ► from page 10.4

For various possibilities
Multi-Clamps

New in this catalog!



Chainfix-Adapter. Save assembly time, space and money. Compact and modular. For small outer diameters ► page 10.6

For top hat rail and C-profile
Biggets

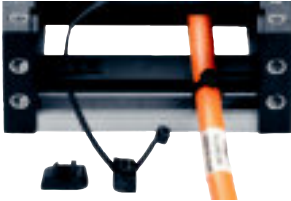

Completely simple and universal cable fixation for top hat rail and C-profile
 ► page 10.10

Separators with integrated strain relief
Strain relief separators

New size!



Separator with integrated strain relief - easy strain relief with cable tiewraps
 ► page 10.11

Strain relief for hoses
Blocks



igus® blocks - Special strain relief for hoses. A Modular, space-saving system
 ► page 10.11

igus® classics - older products are still available! - for new designs we recommend E2000

Classic-Series
E2 medium | bh snap-open



25-45
 bh snap-open.
 Double stop dog system
 ► from page 12.4

Classic-Series
E2 medium | Snap-open



25-45
 Snap-open along inner radius.
 Double stop dog system
 ► from page 12.6

Classic-Series
E2 medium | Snap-open



25-45
 Snap-open along outer radius.
 Double stop dog system
 ► page 12.8

For universal tiewrap, bolted or clip-on
Tiewrap plates



Chainfix tiewrap plates as single parts, suitable for assembly in the KMA mounting brackets **▶ from page 10.8**

Clip-on connection for the C-profile
Tiewrap plates

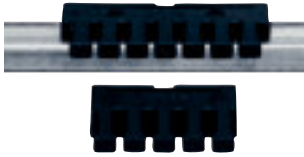

Tiewrap plates with clip-on connection for the C-profile. Easy to assemble and disassemble without any screws **▶ page 10.69**

High tensile forces, modular, clip-on
Clips



For E-Chains® with C-profiles, also suitable for assembly in the KMA mounting brackets and clip-on strain relief for crossbars **▶ from page 10.10**

PMA

Cable protection
PMAFLEX conduits



Conduits
▶ page 11.4

Safety and sealing systems
PMAFIX connectors



Connectors
▶ page 11.4

PMA - Accessories



Accessories
▶ page 11.4

Special solutions

Increased inner height, crossbars every link
Series 38022 | E4/00



 Based on Series 380 - version with increased inner height **▶ from page 12.12**

Increased inner height, crossbars every link
Series 383822 | E4/4



 Based on Series 3838 - version with increased inner height **▶ from page 12.14**

Special solution
E-Band

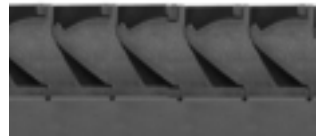

 Low-abrasion chain links are suitable for cleanroom applications **▶ page 12.18**

News 2009

in this catalog and online

Triflex® R (TRC/TRE)
New size: 125 (Ø135 mm)



The now largest 3D igus® E-Chain® for very large fill packages as TRC- and TRE-version ► [page 2.12](#)

Triflex® RS
Universal modul, new size: 100



The approved universal modul robotic movements now with Triflex® R size 100 ► [page 2.22](#)

Triflex® RS - Adapter brackets
for 43 robots from stock



43 adapter bracket types for many different robots and RS-modules from stock - please download 3D-data ► www.igus.eu/triflexconsole ► [page 2.23](#)

Fixation to axis 6
for all robots



Easy and fast fixation to axis 6 ► [page 2.23](#)

Line extension -
Two-piece E2 mini E-Chains®, Series B17i

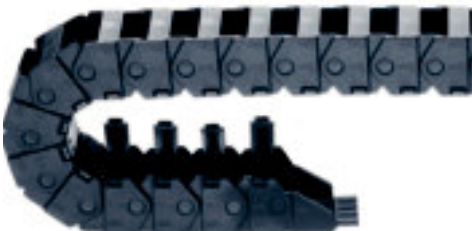

Series B17 snap-open along outer radius with film-hinge ► [page 5.76](#)

Line extension -
E2/000-Tubes



New widths for the E2/000-allrounder E-Tubes Series 3450/3480 ► [page 5.118](#)

Triflex® R
Quick exchange kit



Quick exchange of hose packages within seconds, without tools
▶ page 2.21

Triflex® R
QuickLock protector



Easy and fast assembly, no additional screws
▶ page 2.25

TwisterChain® - Better guidance for circular motion - increase cycle life



New Guide Trough system for igus® TwisterChain® . Reduce installation time and increase cycle life
▶ page 2.70

Quick assembly with Easy Chain®
Now available as ESD



Cost effective and easy to fill E-Chains® for ESD/Atex applications
▶ chapter 3

Totally new, two-piece E-Tube RX
with chip repellent design



A world premiere from igus®- a totally redesigned E-Tube - repels chips, is extremely tight, and can still be opened!
▶ page 6.50

E4 E-Tubes with snap-on lids
made of Polymer or Aluminum

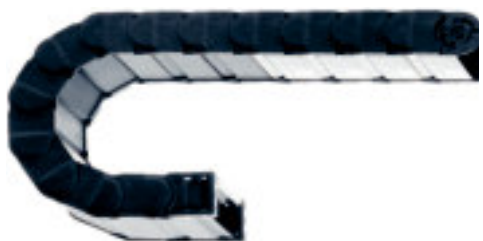

Another world premiere against chips. Lids with special seals are clipped onto an E-Chain®. All existing elements are still useable - absolutely chip-tight! ▶ www.igus.eu/spaene

News 2009

in this catalog and online

New: Interior separator kit for System E4.1

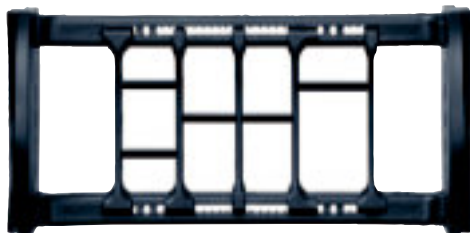

Guide cables precisely and increase cycle life. Cables last up to 4 times. Better interior separation with fewer parts ► [page 7.12](#)

Crossbars with notch teeth for side-mounted applications



Notch teeth on the crossbar ensure safe fit against the notch separators, for side-mounted applications. The additional, plane surface scaling makes exact positioning of the separator easy ► [page 7.12](#)

E-Chains® and modules for circular movement - ex stock

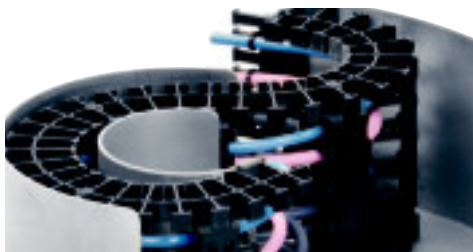

Small circular T3 modules for reverse bending radii (RBR). Available from stock as complete system. ► www.igus.eu/circularmovement

New widths and new radii for System E3



Small E-Chains® for highly dynamic applications. Inner heights: 10 - 22 mm. IPA Class 1 Certification (DIN ISO EN 14644, E3.15.040.075.0) ► [page 8.4](#)

P4 Rol E-Chain® - new sizes for energy efficient power supply



New sizes complete the tool box for energy efficient power supply on long travels. Save up to ca. 60% power with P4 ► [page 9.78](#)

Avoid chips on long travels Guidelok horizontal



Especially for long, gliding travels on machine tools, metallic chips are a problem. igus® Guidelok is a cost-effective solution ► [page 9.96](#)

Line extension
New widths for enclosed E4.1 E-Tubes



New widths for enclosed E-Tubes, ensuring protection against dirt and chips - Series R4.42 ► [page 7.48](#) and R4.80 ► [page 7.76](#)

Line extension
Extension links for E4.80

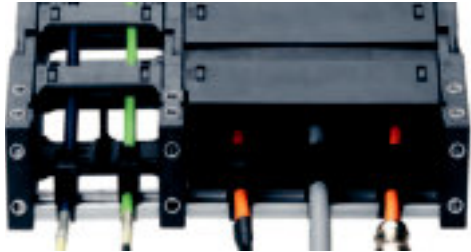

"Infinite" E-Chain® and E-Tube width with igus® extension links. New: Extension links for Series E4.80 and R4.80 ► [page 7.84](#)

New widths and new radii
for System E6



New radius for series E6.35. Wear resistant spring connectors ensure cleanroom compatibility and IPA cleanroom class 1 certification (DIN ISO EN 14644, E6.29.060.150.0.CR) ► [page 8.50](#)

Support for the lower run
Ready made Support Trays



Simple one-piece support trays for the lower E-Chain® run. We supply the fitting E-Chain®, together with the support tray system. Ready to install onto your machine or application ► [page 9.70](#)

Strain relief - even faster
Chainfix clamp



Improved stability and identification with correct install direction for all igus® CFX-clamps ► [page 10.5](#)

Strain relief - more versatile
Chainfix Multi



Chainfix-Adapter for numerous applications. Reduced assembly time and space. Compact and modular. For small diameters, price-saving ► [page 10.6](#)

News 2009

Chainflex®-catalog and online

Cost effective PUR data cable Chainflex® CF112 PUR



Cost-effective data cable features high abrasion-resistant PUR jacket blend and a pressure-extruded PUR inner jacket. Oil resistant, flame-retardant, PVC-free, halogen-free, 10 x d ▶ www.igus.eu/chainflexnews

Cost-effective twisted pair data cable Chainflex® CF113 PUR



The cost-effective twisted pair data cable with a highly flexible overall copper shield. Oil resistant, flame-retardant, PVC-free, halogen-free, 10 x d ▶ www.igus.eu/chainflexnews

Torsion-resistant Chainflex® hybrid cable Chainflex® CFROBOT9



The highly wear-resistant, flame-retardant and halogen free PUR jacket blend protects the braiding elements, torsion angles of $\pm 180^\circ$ with 1 m cable length ▶ www.igus.eu/chainflexnews

Torsion-resistant Chainflex® bus cable Chainflex® CFROBOT8



High abrasion-resistant halogen-free PUR jacket blend with stranded, dampening elements, flame-retardant ▶ www.igus.eu/chainflexnews

MTW, NFPA control cable Chainflex® CF150.MTW



Bundle twisted control cable according to NFPA- Standard. UL listed, oil-proof PVC jacket blend, flame-retardant, 10 x d ▶ www.igus.eu/chainflexnews

MTW, NFPA-cable Chainflex® CF160.MTW



Bundle twisted, shielded control cable according to NFPA- Standard. UL listed, oil-proof PVC jacket blend, flame-retardant, 10 x d ▶ www.igus.eu/chainflexnews

Harnessed TPE Koax cable Chainflex® CFKCoax1



Koax cable for maximum load requirements, TPE outer jacket. Resistant to: oil, also to bio-oils, UV, Hydrolysis and microbe. 10 x d ▶ www.igus.eu/chainflexnews

Chainflex® CFKCoax1.01 and 1.05 Connector-cabel combinations



Harnessed Koax cables for maximum load requirements in many connector-cabel combinations ▶ www.igus.eu/chainflexnews

Cost effective PVC servo cable
Chainflex® CF210.UL PVC



The cost-effective servo cable with oil-proof PVC jacket blend, UL recognized, shielded, oil-resistant, flame-retardant, specifically for the use in unsupported E-Chains®, 10 x d ▶ www.igus.eu/chainflexnews

Cost effective PVC servo cable
Chainflex® CF270.UL.D PVC



The cost-effective, UL/CSA recognized, shielded and oil-resistant and mud-resistant PUR servo cable family. Highly wear-resistant, PVC- and halogen free servo cable, 10 x d ▶ www.igus.eu/chainflexnews

Torsion-resistant Chainflex® motor cable
Chainflex® CFROBOT6



Unshielded, torsion-resistant motor cable for torsion of $\pm 180^\circ$ over a length of 1 m. Highly wear-resistant, flame-retardant and halogen free PUR jacket blend and stranded, dampening elements. ▶ www.igus.eu/chainflexnews

Torsion-resistant Chainflex® motor cable
Chainflex® CFROBOT7



Shielded motor cable. The highly wear-resistant and halogen free PUR jacket blend protects the braiding elements, which are optimized for torsion, torsion $\pm 180^\circ$ with 1 m cable length. Flame-retardant ▶ www.igus.eu/chainflexnews

Fiber optic cable
Chainflex® CFLG.2LB



Universal bus cable with highly wear-resistant TPE jacket blend, gradient glass fibers, PVC-free, halogen-free, 5 x d. High cycle counts and bending radii of only 40 mm ▶ www.igus.eu/chainflexnews

invis® Power
Small PickUp

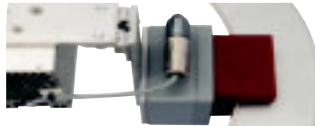

Inductive, contactless power transmission, small and light. 150 W peak capacity, 120 W continuous output. Output: 560 V DC ▶ www.igus.eu/chainflexnews

Drive systems in 24-48 hours
Harnessed power-, servo- and encoder cables



New for B&R, Danaher Motion, Heidenhain and ELAU, any required length available. Perfect service life even with small bending radii, PVC, PUR, TPE. High availability for short lead time ▶ www.igus.eu/chainflexnews

Shielded initiators
Chainflex® CF10.INI



Shielded initiator with shield and a bending radius of 5 x d. The ideal solution for high speed applications, small bending radii, space restrictions ▶ www.igus.eu/chainflexnews

**Spiral moves in minutes
Generate 3D-models online**



Generate fast complete 3D-models for spiral moves with RB®

► www.igus.eu/rb-configurator

Generate fast complete TwisterChain® 3D-models with guide troughs and accessories

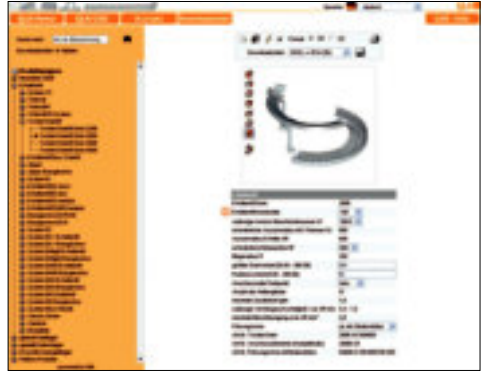

Calculate the E-Chain® length with entering only the rotation angle

► www.igus.eu/twisterconfigurator

**E-Chain® Expert 2.0
Easy layout of your E-Chain®**

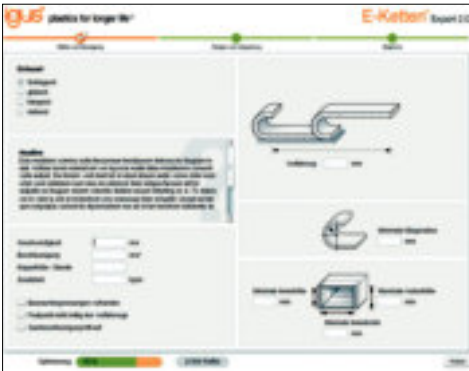

Calculation and layout of E-Chains® for unsupported, gliding, hanging and standing applications. Upon data entry on travel length, speed, acceleration and fill weight, the E-Chain® Expert recommends the E-Chain®, that fits your application ► www.igus.eu/online-tools

**Assessing in minutes
ReadyChain® Basic configurator**



Layout of complete E-Chains®, with interior separation, cables/hoses and strain relief. For registered customers/users the ReadyChain® Basic configurator is available online ► www.igus.eu/online-tools

**QuickPin 2.0
Online Pinout-Configurator**



**Cycle life calculation
for E-Chains®**



In only 3 minutes you choose out of 750 Chainflex® cables and 3,500 connector components, configure cables online, order directly and generate ePLAN electric P8 macro ► www.igus.eu/quickpin

With just a few clicks, you will find out the expected cycle life of an E-Chain® ► www.igus.eu/Echain-lifetime

**Quick search for industry solutions -
Find a reference!**



More than 470 inspiring applications examples with E-ChainSystems® and polymer bearings. Browse through already implemented customer applications and filter them ► www.igus.eu/industrysolutions

**Individual customer catalog -
Reduce processing costs!**



Now igus® can compose individual online catalogs from more than 80.000 products according to the customers desires. The administration takes place in the existing "myigus" customer system. ► www.igus.eu/customercatalog

Technical Details | Triflex® R | Triflex® | TwisterChain®

Legend

- Standard
- Suitable to a limited extent
- ▲ Options
- Especially suitable
- * In preparation / on request

Opening principle



Series / Product

Inner height hi [mm] +
ø cable max.



Inner width Bi [mm]
from - to



Outer height ha [mm]



Outer width Ba [mm]
from - to



Bending radius R [mm]
from - to



Triflex® R - 3D E-Chain® for robot applications

TRC - closed design



TRC.30	12/10	ø 10	12/10	ø 34,5	ø 34,5	50
TRC.40	15/13	ø 13	15/13	ø 43	ø 43	58
TRC.60	22,5/19,5	ø 20,5	22,5/19,5	ø 65	ø 65	87
TRC.70	28/24	ø 26	28/24	ø 81	ø 81	110
TRC.85	33/28	ø 31	33/28	ø 94,5	ø 94,5	135
TRC.100	37,5/32,5	ø 35,5	37,5/32,5	ø 108	ø 108	145
TRC.125 <small>New</small>	43,3/43,3	ø 41	43,3/43,3	ø 135	ø 135	182

TRE - "Easy" design for fast installation of conduits



TRE.30	12/10	ø 10	12/10	ø 34,5	ø 34,5	50
TRE.40	15/13	ø 13	15/13	ø 43	ø 43	58
TRE.60	22,5/19,5	ø 20,5	22,5/19,5	ø 65	ø 65	87
TRE.70	28/24	ø 26	28/24	ø 81	ø 81	110
TRE.85	33/28	ø 31	33/28	ø 94,5	ø 94,5	135
TRE.100	37,5/32,5	ø 35,5	37,5/32,5	ø 108	ø 108	145
TRE.125 <small>New</small>	43,3/43,3	ø 41	43,3/43,3	ø 135	ø 135	182

TRL - light version with "Easy" Design



TRL.30	12/10	ø 10	12/10	ø 34,5	ø 34,5	50
TRL.40	15/13	ø 13	15/13	ø 45	ø 45	58
TRL.60	22,5/19,5	ø 20,5	22,5/19,5	ø 65	ø 65	87
TRL.70	28/24	ø 26	28/24	ø 81	ø 81	110
TRL.100	37,5/32,5	ø 35,5	37,5/32,5	ø 108	ø 108	145

Easy Triflex® - for 3D motion - simple filling from 2 sides

"Easy" design for fast installation of conduits



E332.25	25	ø 09	25	34	34	48 - 200
E332.32	32	ø 12	32	50	50	75 - 250
E332.50	50	ø 21	50	68	68	100 - 250
E332.75	75	ø 33	75	96	96	140 - 300
E333.25	25	ø 09	25	34	34	48 - 200
E333.32	32	ø 12	32	50	50	75 - 250
E333.50	50	ø 21	50	68	68	100 - 250
E333.75	75	ø 33	75	96	96	140 - 300

Triflex® - for 3D motion - closed

Closed design



332.16	16	ø 14	16	26	26	38 - 100
332.32	32	ø 28	32	50	50	75 - 250
332.50	50	ø 45	50	68	68	100 - 250
332.75	75	ø 67	75	96	96	140 - 300
333.16	16	ø 14	16	26	26	38 - 100
333.32	32	ø 28	32	50	50	75 - 250
333.50	50	ø 45	50	68	68	100 - 250
333.75	75	ø 67	75	96	96	140 - 300

To open











352.50	50	ø 45	50	68	68	100 - 250
353.50	50	ø 45	50	68	68	100 - 250

TwisterChain® - for circular and spiral movements

To open from both sides



2208	28	ø 25	52,5 - 112,5	42	80 - 140	55 - 150
2808	32	ø 29	50 - 150	54	81 - 181	100 - 250
3808	42	ø 39	50 - 200	64	85 - 235	100 - 250
4008	56	ø 53	50 - 200	84	93 - 243	150 - 400

Pitch [mm]	Unsupported fill weight max [kg/m]		Unsupported length E_{β} max [m]	Long travel max [m]	Interior separation possibilities			ESD/ATEX 	Cleanroom 	UL-V2 	Low noise 	Price index 	Page
					Separators 	Full-width shelves 	Shelves 						
11,3	-	-	-	-	●	-	-	*	○	●	●	●●●	2.12
13,9	-	-	-	-	●	-	-	▲	○	●	●	●●●	2.12
20,4	-	-	-	-	●	-	-	▲	○	●	●	●●●	2.12
25,6	-	-	-	-	●	-	-	▲	○	●	●	●●●	2.12
30,6	-	-	-	-	●	-	-	▲	○	●	●	●●●	2.12
34,5	-	-	-	-	●	-	-	▲	○	●	●	●●●	2.12
44,6	-	-	-	-	●	-	-	▲	○	●	●	●●●	2.12
11,3	-	-	-	-	●	-	-	-	○	●	●	●●●	2.14
13,9	-	-	-	-	●	-	-	-	○	●	●	●●●	2.14
20,4	-	-	-	-	●	-	-	-	○	●	●	●●●	2.14
25,6	-	-	-	-	●	-	-	-	○	●	●	●●●	2.14
30,6	-	-	-	-	●	-	-	-	○	●	●	●●●	2.14
34,5	-	-	-	-	●	-	-	-	○	●	●	●●●	2.14
44,6	-	-	-	-	●	-	-	-	○	●	●	●●●	2.14
11,3	-	-	-	-	●	-	-	-	○	●	●	●●●	2.16
13,9	-	-	-	-	●	-	-	-	○	●	●	●●●	2.16
20,4	-	-	-	-	●	-	-	-	○	●	●	●●●	2.16
25,6	-	-	-	-	●	-	-	-	○	●	●	●●●	2.16
34,5	-	-	-	-	●	-	-	-	○	●	●	●●●	2.16
14,5	-	-	-	-	●	-	-	▲	○	●	●	●●●	2.36
25	-	-	-	-	●	-	-	▲	○	●	●	●●●	2.36
30	-	-	-	-	●	-	-	▲	○	●	●	●●●	2.36
36	-	-	-	-	●	-	-	▲	○	●	●	●●●	2.36
14,5	-	-	-	-	●	-	-	▲	○	●	●	●●●	2.36
25	-	-	-	-	●	-	-	▲	○	●	●	●●●	2.36
30	-	-	-	-	●	-	-	▲	○	●	●	●●●	2.36
36	-	-	-	-	●	-	-	▲	○	●	●	●●●	2.36
13,3	-	-	-	-	-	-	-	▲	○	▲	○	●●●	2.48
25	-	-	-	-	●	-	-	▲	○	▲	○	●●●	2.48
30	-	-	-	-	●	-	-	▲	○	▲	○	●●●	2.48
36	-	-	-	-	●	-	-	▲	○	▲	○	●●●	2.48
13,3	-	-	-	-	-	-	-	▲	○	▲	○	●●●	2.48
25	-	-	-	-	●	-	-	▲	○	▲	○	●●●	2.48
30	-	-	-	-	●	-	-	▲	○	▲	○	●●●	2.48
36	-	-	-	-	●	-	-	▲	○	▲	○	●●●	2.48
30	-	-	-	-	●	-	-	▲	○	▲	○	●●●	2.48
30	-	-	-	-	●	-	-	▲	○	▲	○	●●●	2.48
	Fill weight max [kg/m] 180° 360°												
44	1,5	1	-	-	●	●	●	▲	○	▲	●	●●●	2.64
56	2	1	-	-	●	●	●	▲	○	▲	●	●●●	2.65
67	3	1,8	-	-	●	●	●	▲	○	▲	●	●●●	2.66
91	4	2,5	-	-	●	●	●	▲	○	▲	●	●●●	2.67 19

Technical Details | Zipper | Easy Chain® | System E1

Legend

- Standard
- Suitable to a limited extent
- ▲ Options
- Especially suitable
- * In preparation / on request

Öpening principle



Series / Product

Inner height hi [mm] +
ø cable max.



Inner width Bi [mm] from - to



Outer height ha [mm]



Outer width Ba [mm] from - to



Bending radius R [mm] from - to



Easy Chain® - very easy to fill - simply press cables in

E-Version, split crossbar along the outer radius



Series / Product	Inner height hi [mm] + ø cable max.	Inner width Bi [mm] from - to	Outer height ha [mm]	Outer width Ba [mm] from - to	Bending radius R [mm] from - to
E03	5	ø 3	5 - 10	8	8,7 - 13,7
E04	7	ø 4,5	7	10	13
E045	9,4	ø 5,5	10 - 27	12,5	16 - 37
E06	10,7	ø 6,5	10 - 20	15	16,5 - 26,5
E065	11,3	ø 7	16 - 36	15	24,8 - 49,3
E08	14,6	ø 10	10 - 50	19,3	18,2 - 58,2
E14	19	ø 13	15 - 50	25	27 - 62
E200	24,3	ø 20	57	35	74,4
E200.2	24,3	ø 18	37 - 50	35	94,4 - 120,4
E16	32	ø 25	23 - 100	39	37,5 - 115,3
E26	36,5	ø 28	75	50	92
E26.2	37,1	ø 20	48 / 48	50	117
E26.3	37,1	ø 20	47 / 48 / 47	50	167
E300	48,5	ø 35	75	64	95
E300.2	48,5	ø 18	48 / 48	64	120
E300.3	48,5	ø 18	47 / 46 / 47	64	170

Z-Version, split crossbar along the inner radius



Series / Product	Inner height hi [mm] + ø cable max.	Inner width Bi [mm] from - to	Outer height ha [mm]	Outer width Ba [mm] from - to	Bending radius R [mm] from - to
Z045	9,4	ø 5,5	14 - 16	12,5	23
Z06	10,5	ø 6,5	10 - 16	15	16,5 - 22,5
Z08	14,7	ø 10	10 - 50	19,3	18,2 - 58,2
Z14	19	ø 13	15 - 50	25	27 - 62
Z200	24,3	ø 20	57	35	74,4
Z200.2	24,3	ø 18	37 - 50	35	94,4 - 120,4
Z16	32	ø 25	23 - 100	39	37,5 - 115,3
Z26	36,5	ø 28	75	50	92
Z26.2	37,1	ø 20	48 / 48	50	117
Z26.3	37,1	ø 20	47 / 48 / 47	50	167
Z300	48,5	ø 35	75	64	95
Z300.2	48,5	ø 18	48 / 48	64	120
Z300.3	48,5	ø 18	47 / 46 / 47	64	170

System E1 - modular, 1-piece strip design for simple applications

zip-open along the outer radius



Series / Product	Inner height hi [mm] + ø cable max.	Inner width Bi [mm] from - to	Outer height ha [mm]	Outer width Ba [mm] from - to	Bending radius R [mm] from - to
E1.10	10	ø 9	13	15,5	16,5
E1.17	17	ø 15	21 - 44	25	26 - 49
E1.20	20	ø 18	15	27	22

Zipper E-Chains® and E-Tubes - lightning-fast opening and closing

E-Chains®, zip-open along the outer radius











Series / Product	Inner height hi [mm] + ø cable max.	Inner width Bi [mm] from - to	Outer height ha [mm]	Outer width Ba [mm] from - to	Bending radius R [mm] from - to
047	9	ø 7	10 - 16	12,5	16 - 22
07	10,3	ø 8	6 - 64	15	12,5 - 71
09	15	ø 13	10 - 50	19,3	18,2 - 58,2
15	17	ø 15	15 - 100	24	26 - 113
17	32	ø 28	15 - 100	39	26 - 113

E-Tubes, zip-open along the outer radius



Series / Product	Inner height hi [mm] + ø cable max.	Inner width Bi [mm] from - to	Outer height ha [mm]	Outer width Ba [mm] from - to	Bending radius R [mm] from - to
R07	10,3	ø 8	10 - 50	15	16,5 - 57
R09	15	ø 12,5	10 - 50	19,3	18,2 - 58,2
R15	17	ø 15	25 - 80	24	36 - 94
R17	32	ø 28	15 - 63	39	26 - 76

Pitch [mm]	Unsupported fill weight max [kg/m]	Unsupported length FL_B max [m]	Long travel max [m]	Interior separation possibilities			ESD/ATEX 	Cleanroom 	UL-V2 	Low noise 	Price index 	Page
				Separators 	Full-width shelves 	Shelves 						
10	0,23	0,4	-	-	-	-	○	■	●	■	●●●	3,6
16,7	0,35	0,55	-	-	-	-	▲	■	●	●	●●●	3,10
13	0,25	0,4	-	●	-	-	▲	■	●	■	●●●	3,14
20	0,45	0,55	-	-	-	-	▲	■	●	●	●●●	3,20
15	0,45	0,6	-	●	-	-	▲	■	●	●	●●●	3,24
20	0,7	1	-	-	-	-	▲	■	●	●	●●●	3,28
30,5	0,5	0,65	-	-	-	-	▲	■	●	●	●●●	3,32
46	2	1,75	-	-	-	-	▲	■	●	●	●●●	3,36
46	2	1,75	-	●	-	-	▲	■	●	●	●●●	3,36
30,5	0,7	1	-	-	-	-	▲	■	●	●	●●●	3,42
56	4	2	-	-	-	-	▲	■	●	●	●●●	3,46
56	4	2	-	●	-	-	▲	■	●	●	●●●	3,46
56	4	2	-	●	-	-	▲	■	●	●	●●●	3,46
67	8	2,25	-	-	-	-	▲	■	●	●	●●●	3,52
67	8	2,25	-	●	-	-	▲	■	●	●	●●●	3,52
67	8	2,25	-	●	-	●	▲	■	●	●	●●●	3,52
13	0,25	0,4	-	●	-	-	▲	■	●	■	●●●	3,14
20	0,45	0,55	-	-	-	-	▲	■	●	●	●●●	3,20
20	0,7	1	-	-	-	-	▲	■	●	●	●●●	3,28
30,5	0,5	0,65	-	-	-	-	▲	■	●	●	●●●	3,32
46	2	1,75	-	-	-	-	▲	■	●	●	●●●	3,36
46	2	1,75	-	●	-	-	▲	■	●	●	●●●	3,36
30,5	0,7	1	-	-	-	-	▲	■	●	●	●●●	3,42
56	4	2	-	-	-	-	▲	■	●	●	●●●	3,46
56	4	2	-	●	-	-	▲	■	●	●	●●●	3,46
56	4	2	-	●	-	-	▲	■	●	●	●●●	3,46
67	8	2,25	-	-	-	-	▲	■	●	●	●●●	3,52
67	8	2,25	-	●	-	-	▲	■	●	●	●●●	3,52
67	8	2,25	-	●	-	●	▲	■	●	●	●●●	3,52
20	*	-	-	-	-	-	○	●	▲	●	●●●	3,64
25,5	*	-	-	-	-	-	○	●	▲	●	●●●	3,64
25	*	-	-	-	-	-	○	●	▲	●	●●●	3,64
13	0,25	0,4	-	-	-	-	○	●	▲	■	●●●	4,6
20	0,4	0,55	-	-	-	-	○	●	▲	■	●●●	4,10
20	0,7	1	-	-	-	-	○	●	▲	■	●●●	4,14
30,5	1,5	1,2	-	●	●	-	○	●	▲	■	●●●	4,18
30,5	1	1	-	●	●	-	○	●	▲	■	●●●	4,24
20	0,4	0,55	-	-	-	-	○	●	▲	■	●●●	4,28
20	0,7	1	-	-	-	-	○	●	▲	■	●●●	4,32
30,5	1,5	1,2	-	●	●	-	○	●	▲	■	●●●	4,36
30,5	1,5	1,2	-	●	●	-	○	●	▲	■	●●●	4,42

Technical Details | E2 micro | E2 mini | E2/000

Legend

- Standard
- Suitable to a limited extent
- ▲ Options
- Especially suitable
- * In preparation / on request

Opening principle



Series / Product

Inner height hi [mm] +
ø cable max.



Inner width Bi [mm]
from - to



Outer height ha [mm]



Outer width Ba [mm]
from - to



Bending radius R [mm]
from - to



E2 micro - one-piece E-Chains® - small sizes

E2 micro, non snap-open



Series / Product	Inner height hi [mm] + ø cable max.	Inner width Bi [mm] from - to	Outer height ha [mm]	Outer width Ba [mm] from - to	Bending radius R [mm] from - to
03	5	ø 3,5	5 - 10	8	8,7 - 13,7
04	7	ø 5	7 - 30	10	12 - 35
045	10,3	ø 8	6 - 64	12,5	12 - 70
05	10	ø 8	6 - 64	12	10 - 68
06	10,5	ø 8	6 - 64	15	12,5 - 71
08	15	ø 12	10 - 50	19,3	18,2 - 58,2

E2 micro, snap-open along outer radius



B07 <i>New</i>	10,3	ø 8	16 - 40	15	22,5 - 47
B09 <i>New</i>	14,3	ø 12,5	16 - 40	19,3	24,2 - 48,2

E2 mini - one/two-piece E-Chains® - small and medium sizes

E2 mini, non snap-open



10	18	ø 16	15 - 100	23	26 - 113
11.031	23	ø 21	31	28	41,2
11.080	28	ø 26	80	33,4	93
11.1/11.2	41	ø 22	15 - 25	46	25,5 - 35,5

E2 mini, snap-open along inner radius



14	20	ø 16	15 - 50	25	26 - 61
B15i	17	ø 14	15 - 100	23	26 - 113
B17i <i>New</i>	32	ø 28	38	39	48,5
F7	32	ø 28	15	39	26

E2 mini, snap-open along outer radius



B15	17	ø 14	15 - 100	23	26 - 113
B17	32	ø 28	15 - 100	39	25,5 - 113



E2/000 E-Chain® - two-piece E-Chains® - the E2 standard!

E2/000, snap-open along inner radius



1400	21	ø 18	15 - 125	28	28,5 - 138,5
2400	25	ø 23	25 - 125	35	41 - 141
2600	35	ø 32	50 - 175	50	66 - 194
3400	45	ø 42	50 - 250	64	70 - 270

E2/000, snap-open along outer radius



1500	21	ø 18	15 - 125	28	28,5 - 138,5
2500	25	ø 23	25 - 125	35	41 - 141
2700	35	ø 32	50 - 175	50	66 - 194
3500	45	ø 42	50 - 250	64	70 - 270
255	24	ø 22	38 - 103	35	54 - 119

E2/000, snap-open along inner radius











1450	21	ø 18	15 - 125	28	28,5 - 138,5
2450	25	ø 23	25 - 103	35	41 - 119
2650	35	ø 32	50 - 125	50	66 - 141
3450	45	ø 42	75 - 225	64	95 - 245

E2/000, snap-open along inner radius



1480	21	ø 18	15 - 125	28	28,5 - 138,5
2480	25	ø 23	38 - 103	35	54 - 119
2680	35	ø 32	50 - 125	50	66 - 141
3480	45	ø 42	75 - 175	64	95 - 195

Pitch [mm]	Unsupported fill weight max [kg/m]	Unsupported length FL_B max [m]	Long travel max [m]	Interior separation possibilities			ESD/ATEX 	Cleanroom 	UL-V2 	Low noise 	Price index 	Page
				Separators 	Full-width shelves 	Shelves 						
10	0,24	0,4	-	-	-	-	○	○	▲	■	●●●	5.10
16,7	0,35	0,5	-	-	-	-	▲	○	▲	●	●●●	5.14
13	0,25	0,5	-	▲	-	-	▲	○	▲	■	●●●	5.18
20	0,375	0,55	-	-	-	-	▲	○	▲	●	●●●	5.22
20	0,48	0,6	-	▲	-	-	▲	○	▲	●	●●●	5.26
20	0,75	1	-	-	-	-	▲	○	▲	●	●●●	5.34
20	0,4	0,55	-	-	-	-	○	●	▲	■	●●●	5.30
20	0,7	1	-	-	-	-	○	●	▲	■	●●●	5.38
30,5	1,5	1,2	-	●	-	-	▲	●	▲	●	●●●	5.48
30,5	1,5	1,35	-	-	-	-	▲	○	▲	●	●●●	5.54
30,5	1,5	1,5	-	-	-	-	▲	○	▲	●	●●●	5.58
30,5	1,5	1,35	-	-	-	-	▲	○	▲	●	●●●	5.62
30,5	0,5	0,65	-	-	-	-	▲	■	▲	●	●●●	5.66
30,5	1,5	1,2	-	●	●	-	▲	●	▲	●	●●●	5.70
30,5	1	1	-	●	●	-	▲	○	▲	●	●●●	5.76
30,5	1,5	1,2	-	●	●	-	▲	○	▲	●	●●●	5.82
30,5	1,5	1,2	-	●	●	-	▲	●	▲	●	●●●	5.70
30,5	1	1	-	●	●	-	▲	○	▲	●	●●●	5.76
33,3	2	1,75	75*	●	●	-	▲	○	-	●	●●●	5.92
46	5	2,25	100*	●	●	●	▲	●	-	●	●●●	5.102
56	8	2,75	120*	●	●	●	▲	○	-	●	●●●	5.114
67	13	3	150*	●	●	●	▲	○	-	●	●●●	5.126
33,3	2	1,75	75	●	●	-	▲	○	-	●	●●●	5.92
46	5	2,25	100	●	●	●	▲	●	-	●	●●●	5.102
56	8	2,75	120	●	●	●	▲	○	-	●	●●●	5.114
67	13	3	150	●	●	●	▲	○	-	●	●●●	5.126
27,8	2	1,8	100	●	●	●	▲	●	-	■	●●●	5.138
33,3	2	1,75	75*	●	●	-	▲	○	-	●	●●●	5.92
46	5	2,25	100*	●	●	▲	▲	○	-	●	●●●	5.102
56	8	2,75	120*	●	●	●	▲	○	-	●	●●●	5.114
67	13	3	150*	●	●	●	▲	○	-	●	●●●	5.126
33,3	2	1,75	75*	●	●	-	▲	○	-	○	●●●	5.92
46	5	2,25	100*	●	●	▲	▲	○	-	○	●●●	5.102
56	8	2,75	120*	●	●	●	▲	○	-	○	●●●	5.114
67	13	3	150*	●	●	●	▲	○	-	○	●●●	5.126

*Conditionally suitable in inner radii

Technical Details E-Tubes | R100 | R | RX

Legend

- Standard
- Suitable to a limited extent
- ▲ Options
- Especially suitable
- * In preparation / on request

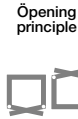

Series / Product

Inner height h_i [mm] + \varnothing cable max.



Inner width B_i [mm] from - to



Outer height h_a [mm]



Outer width B_a [mm] from - to



Bending radius R [mm] from - to



E2 R100 - two-piece E-Tube - hinged lids

E2 R100, snap-open along inner radius



Series / Product	Inner height h_i [mm]	\varnothing cable max.	Inner width B_i [mm]	Outer height h_a [mm]	Outer width B_a [mm]	Bending radius R [mm]
R117	21	\varnothing 17	20 - 100	28	32 - 112	63 - 180
R157	40	\varnothing 37	40 - 200	50	56 - 216	100 - 250
R167	50	\varnothing 46	50 - 250	64	68 - 268	100 - 300

E2 R100, snap-open along outer radius



Series / Product	Inner height h_i [mm]	\varnothing cable max.	Inner width B_i [mm]	Outer height h_a [mm]	Outer width B_a [mm]	Bending radius R [mm]
R118	21	\varnothing 17	25 - 80	28	37 - 92	63 - 180
R158	40	\varnothing 37	40 - 200	50	56 - 216	100 - 250
R168	50	\varnothing 46	50 - 200	64	68 - 218	100 - 300

E2 R - two-piece E-Tubes - small pitch

E2 R, snap-open along outer radius



Series / Product	Inner height h_i [mm]	\varnothing cable max.	Inner width B_i [mm]	Outer height h_a [mm]	Outer width B_a [mm]	Bending radius R [mm]
R48	25	\varnothing 22	25 - 130	36	36 - 141	60 - 250
R58	35	\varnothing 32	50 - 200	50	66 - 216	75 - 250
R68	45	\varnothing 42	50 - 250	64	68 - 268	100 - 300

RX full chip protection without undercuts, projecting edges and gaps









E2 RX snap-open along outer radius



Series / Product	Inner height h_i [mm]	\varnothing cable max.	Inner width B_i [mm]	Outer height h_a [mm]	Outer width B_a [mm]	Bending radius R [mm]
RX0 New	52	\varnothing 48	100	70	123	100

Further E-Tube versions at a glance

Series	Product	Inner height h_i [mm]	Inner width B_i [mm]	Supported length max. [m]	Page
System "upper" - 1-piece, small tubes, snapping due to upper-principle					
R07	upper	10,3	10 - 50	0,55	4.28
R09	upper	15	10 - 50	1	4.32
R15	upper	17	25 - 80	1,2	4.36
R17	upper	32	15 - 63	1,2	4.42
System E2/000 - 2-piece E-Tubes for medium loads, to open from the left or right side					
1480	E2/000	21	15 - 125	1,75	5.92
2480	E2/000	25	25 - 125	2,25	5.102
2680	E2/000	35	50 - 125	2,75	5.114
3480	E2/000	45	75 - 175	3	5.126
E4.1 - Standard, for almost all applications, long travels and high unsupported lengths					
R4.28	E4.1	28	50 - 300	2,5	7.24
R4.32	E4.1	32	50 - 300	3,3	7.34
R4.42	E4.1	42	50 - 300	4	7.48
R4.56	E4.1	56	75 - 462	5	7.62
R4.80	E4.1	80	200 - 400	6,2	7.76
R1608	E4.1	112	200 - 400	4,5	7.96

Pitch [mm]	Unsupported fill weight max [kg/m]	Unsupported length FL_B max [m]	Long travel max [m]	Interior separation possibilities			ESD/ATEX 	Cleanroom 	UL-V2 	Low noise 	Price index 	Page
				Separators 	Full-width shelves 	Shelves 						
30,5	1,5	1,2	-	●	-	-	▲	○	-	○	●●●●	6.6
46	8	2,25	-	●	●	●	▲	○	-	○	●●●●	6.12
58,8	10	2,5	-	●	●	●	▲	○	-	○	●●●●	6.20
30,5	1,5	1,2	-	●	-	-	▲	○	-	○	●●●●	6.6
46	8	2,25	-	●	●	●	▲	○	-	○	●●●●	6.12
58,8	10	2,5	-	●	●	●	▲	○	-	○	●●●●	6.20
30,3	1	1,5	50	●	▲	-	▲	○	-	●	●●●●	6.26
33,3	8	2,3	75	●	●	●	▲	○	-	●	●●●●	6.34
36	10	2,5	100	●	●	●	▲	○	-	●	●●●●	6.42
40	5	1,5	-	●	●	-	▲	○	-	●	●●●●	6.56

Further E-Tube versions at a glance

Series	Product	Inner height hi [mm]	Inner width Bi [mm]	Unsupported length max. [m]	Page
E4/light - economical and light weight, 4-piece E-Tube for short unsupported travels					
R18840	E4/light	56	75 - 462	4	7.124
R19850	E4/light	80	75 - 462	4,6	7.144
E4/00 - easy to assemble, 4-piece E-Tube with increased inner heights					
R760	E4/00	28	50 - 300	2	7.162
R770	E4/00	32	50 - 300	3	7.170
R780	E4/00	42	50 - 300	3,8	7.180
R880	E4/00	56	75 - 462	4,5	7.190
R608	E4/00	108	200 - 400	7	7.200
E4/4 - robust, 4-piece E-Tube for rough environments and special installations					
R7728	E4/4	32	50 - 300	3	7.224
R7838	E4/4	42	50 - 300	3,8	7.236
R8840	E4/4	56	75 - 462	4,5	7.248
R9850	E4/4	80	75 - 462	6	7.268
System E6 - almost no abrasion, low noise and vibration-free running for medium loads					
R6.29	E6	28	30 - 120	1,75	8.46
R6.40	E6	40	62	2,75	8.62
R6.52	E6	52	50 - 175	3	8.72

Technical Details | System E4.1 | E4/light

Legend

- Standard
- Suitable to a limited extent
- ▲ Options
- Especially suitable
- * In preparation / on request

Opening principle



Series / Product

Inner height
 h_i [mm] +
ø cable max.



Inner width
 B_i [mm]
from - to



Outer height
 h_a [mm]



Outer width
 B_a [mm]
from - to



Bending radius
 R [mm]
from - to



Standard E4.1 - OE E-Chain[®] family for all applications

E4.1 - crossbars every link robust version



Series E421 is structurally identical to Series 210 and will replace them



Series / Product	Inner height h_i [mm] + ø cable max.	Inner width B_i [mm] from - to	Outer height h_a [mm]	Outer width B_a [mm] from - to	Bending radius R [mm] from - to
E4.21**	21 ø 18	30 - 120	28	44 - 134	38 - 200
E4.28	28 ø 25	40 - 300	42	60 - 320	55 - 250
E4.32	32 ø 28	50 - 400	54	73 - 423	63 - 300
E4.42	42 ø 38	50 - 400	64	76 - 426	75 - 350
E4.56	56 ø 50	50 - 600	84	84 - 634	135 - 500
E4.80	80 ø 74	50 - 600	108	100 - 650	150 - 1000
1640	112 ø 100	50 - 600	140	84 - 634	200 - 600
800	200 ø 184	200 - 600	236	260 - 660	325 - 1000
840	204 ø 184	100 - 563	236	160 - 623	325 - 1000
E4.350 ^{New}	350 ø 315	200 - 1000	450	340 - 1140	500 - 1000

#1 - crossbars every 2nd link standard version



Series / Product	Inner height h_i [mm] + ø cable max.	Inner width B_i [mm] from - to	Outer height h_a [mm]	Outer width B_a [mm] from - to	Bending radius R [mm] from - to
#32	32 ø 28	50 - 400	54	73 - 423	63 - 300
#42	42 ø 38	50 - 400	64	76 - 426	75 - 350
#56	56 ø 50	50 - 600	84	84 - 634	135 - 500
#80	80 ø 74	50 - 600	108	100 - 650	150 - 1000

R4.1 - E-Tube - fully enclosed - protection against chips, dust and dirt



Series / Product	Inner height h_i [mm] + ø cable max.	Inner width B_i [mm] from - to	Outer height h_a [mm]	Outer width B_a [mm] from - to	Bending radius R [mm] from - to
R4.28	28 ø 25	50 - 300	42	70 - 320	75 - 250
R4.32	32 ø 28	50 - 300	54	73 - 323	125 - 300
R4.42	42 ø 38	50 - 300	64	76 - 326	125 - 350
R4.56	56 ø 50	75 - 462	84	109 - 497	150 - 500
R4.80	80 ø 74	200 - 400	108	250 - 450	200 - 1000
R1608	112 ø 100	200 - 400	140	234 - 434	250 - 600

E4/light - specialty:light weight - low price

E4/light - crossbars every link, snap-open from both sides



Series / Product	Inner height h_i [mm] + ø cable max.	Inner width B_i [mm] from - to	Outer height h_a [mm]	Outer width B_a [mm] from - to	Bending radius R [mm] from - to
14040	56 ø 50	50 - 600	84	76 - 626	135 - 500
14240	62 ø 56	50 - 400	84	76 - 426	135 - 500
15050	80 ø 74	50 - 600	108	80 - 630	150 - 500

E4/light - crossbars every 2nd link, snap-open from both sides











Series / Product	Inner height h_i [mm] + ø cable max.	Inner width B_i [mm] from - to	Outer height h_a [mm]	Outer width B_a [mm] from - to	Bending radius R [mm] from - to
14140	56 ø 50	50 - 600	84	76 - 626	135 - 500
14340	62 ø 56	50 - 400	84	76 - 426	135 - 500
15150	80 ø 74	50 - 600	108	80 - 630	150 - 500

E4/light - E-Tube, fully enclosed, snap-open from both sides



Series / Product	Inner height h_i [mm] + ø cable max.	Inner width B_i [mm] from - to	Outer height h_a [mm]	Outer width B_a [mm] from - to	Bending radius R [mm] from - to
R18840	56 ø 50	75 - 462	84	101 - 489	150 - 500
R19850	80 ø 74	75 - 462	108	105 - 493	200 - 500

Pitch [mm]	Unsupported fill weight max [kg/m]	Unsupported length FL_B max [m]	Long travel max [m]	Interior separation possibilities			ESD/ATEX 	Cleanroom 	UL-V2 	Low noise 	Price index 	Page
				Separators 	Full-width shelves 	Shelves 						

Can be opened from both sides - the E4 standard!

30,5	4	2,5	120	●	●	-	▲■	*	-	▲■	●●●	7.16
46	10	2,5	200	●	●	●	▲■	*	-	▲■	●●●	7.24
56	15	3,3	200	●	-	●	▲■	*	-	▲■	●●●	7.34
67	37	4	300	●	-	●	▲■	*	-	▲■	●●●	7.48
91	62,5	5	400	●	-	●	▲■	*	-	▲■	●●●	7.62
111	80	6,2	400	●	-	●	▲■	*	-	▲■	●●●	7.76
143	50	4,5	400	●	-	●	▲■	○	-	●	●●●	7.90
250	90	8	450	●	-	●	▲	○	-	■	●●●	7.100
250	90	8	450	●	-	-	▲	○	-	■	●●●	7.106
470	600	6,2	-	●	-	●	*	-	-	-	●●●	7.112

56	15	3,3	200	●	-	●	▲■	*	-	▲■	●●●	7.34
67	37	4	300	●	-	●	▲■	*	-	▲■	●●●	7.48
91	62,5	5	400	●	-	●	▲■	*	-	▲■	●●●	7.62
111	80	6,2	400	●	-	●	▲■	*	-	▲■	●●●	7.76

46	10	2,5	200	●	●	●	▲■	*	-	▲■	●●●	7.24
56	15	3,3	200	●	-	●	▲■	*	-	▲■	●●●	7.34
67	37	4	300	●	-	●	▲■	*	-	▲■	●●●	7.48
91	62,5	5	400	●	-	●	▲■	*	-	▲■	●●●	7.62
111	80	6,2	400	●	-	●	▲■	○	-	▲■	●●●	7.76
143	50	4,5	400	●	-	●	▲■	○	-	●	●●●	7.90

91	40	4	150	●	-	●	▲■	○	-	●	●●●	7.124
91	40	4	150	●	-	●	▲■	○	-	●	●●●	7.134
91	55	4,6	250	●	-	●	▲■	○	-	●	●●●	7.144

91	40	4	150	●	-	●	▲■	○	-	●	●●●	7.124
91	40	4	150	●	-	●	▲■	○	-	●	●●●	7.134
91	55	4,6	250	●	-	●	▲■	○	-	●	●●●	7.144

91	40	4	150	●	-	●	▲■	○	-	●	●●●	7.124
91	55	4,6	250	●	-	●	▲■	○	-	●	●●●	7.144

Technical Details | E4/00 | E4/4

Legend

- Standard
- Suitable to a limited extent
- ▲ Options
- Especially suitable
- * In preparation / on request

Öpening principle



Series / Product

Inner height h_i [mm] + \varnothing cable max.



Inner width B_i [mm] from - to



Outer height h_a [mm]



Outer width B_a [mm] from - to



Bending radius R [mm] from - to



E4/00 - For new designs we recommend E4.1!

E4/00 - crossbars every link - snap-open from both sides



210*	21	ø 18	30 - 120	28	44 - 134	38 - 200
220	28	ø 25	40 - 300	42	60 - 320	55 - 250
280	32	ø 28	50 - 400	54	73 - 423	63 - 300
380	42	ø 38	50 - 400	64	76 - 426	75 - 350
400	56	ø 50	50 - 600	84	84 - 634	135 - 500
600	108	ø 97	200 - 600	140	252 - 652	200 - 1000
640	112	ø 100	87 - 562	140	139 - 614	200 - 1000

*Series E4.21 is structurally identical to Series 210 and will replace them

E4/00 - crossbars every 2nd link, snap-open from both sides



290	32	ø 28	50 - 400	54	73 - 423	63 - 300
390	42	ø 38	50 - 400	64	76 - 426	75 - 350
410	56	ø 50	50 - 600	84	84 - 634	135 - 500
601	108	ø 97	200 - 600	140	252 - 652	200 - 1000

E4/00 - E-Tube, fully enclosed, snap-open from both sides



R760	28	ø 25	50 - 300	42	75 - 320	63 - 250
R770	32	ø 28	50 - 300	54	73 - 323	125 - 300
R780	42	ø 38	50 - 300	64	76 - 326	125 - 350
R880	56	ø 50	75 - 462	84	109 - 497	150 - 500
R608	108	ø 97	200 - 400	140	252 - 452	250 - 1000

E4/4 - For new designs we recommend E4.1!

E4/4 - crossbars every link - snap-open from both sides



2828	28	ø 28	50 - 400	54	74 - 424	63 - 300
3838	42	ø 38	50 - 400	64	77 - 427	75 - 350
4040	56	ø 50	50 - 600	84	86 - 636	135 - 500
5050	80	ø 74	50 - 600	108	100 - 650	150 - 1000

E4/4 HD - "Heavy Duty"- crossbars every link - very sturdy



4040HD	56	ø 50	50 - 600	84	104 - 654	135 - 300
5050HD	80	ø 74	50 - 600	108	110 - 660	200 - 500

E4/4 - crossbars every 2nd link, snap-open from both sides



2928	32	ø 28	50 - 400	54	74 - 424	63 - 300
3938	42	ø 38	50 - 400	64	77 - 427	75 - 350
4140	56	ø 50	50 - 600	84	86 - 636	135 - 500
5150	80	ø 74	50 - 600	108	100 - 650	150 - 1000

E4/4 - E-Tube, fully enclosed, snap-open from both sides



R7728	32	ø 28	50 - 300	54	74 - 324	125 - 300
R7838	42	ø 38	50 - 300	64	77 - 327	125 - 350
R8840	56	ø 50	75 - 462	84	111 - 499	150 - 500
R9850	80	ø 74	75 - 462	108	125 - 513	200 - 1000









E4/4 HD - "Heavy Duty" E-Tube - fully enclosed - very sturdy



R8840HD	56	ø 50	75 - 462	84	129 - 516	150 - 300
R9850HD	80	ø 74	75 - 462	108	135 - 522	200 - 500

For new designs we recommend E4.1!

Continuation 

Pitch [mm]	Unsupported fill weight max [kg/m]	Unsupported length FL_B max [m]	Long travel max [m]	Interior separation possibilities			ESD/ATEX 	Cleanroom 	UL-V2 	Low noise 	Price index 	Page
				Separators 	Full-width shelves 	Shelves 						
30,5	4	2,5	120	●	●	-	▲	●	-	■	●●●	7.16
46	8	2	200	●	●	●	▲	●	-	■	●●●	7.162
56	10	3	200	●	-	●	▲	●	-	■	●●●	7.170
67	30	3,8	300	●	-	●	▲	○	-	■	●●●	7.180
91	48	4,5	400	●	-	●	▲	○	-	■	●●●	7.190
143	65	7	450	●	-	●	▲	○	-	■	●●●	7.200
143	65	7	450	●	-	●	▲	○	-	■	●●●	7.208
56	10	3	200	●	-	●	▲	●	-	■	●●●	7.170
67	30	3,8	300	●	-	●	▲	○	-	■	●●●	7.180
91	48	4,5	400	●	-	●	▲	○	-	■	●●●	7.190
143	65	7	450	●	-	●	▲	○	-	■	●●●	7.200
46	8	2	200	●	●	●	▲	○	-	■	●●●	7.162
56	10	3	200	●	-	●	▲	○	-	■	●●●	7.170
67	30	3,8	300	●	-	●	▲	○	-	■	●●●	7.180
91	48	4,5	400	●	-	●	▲	○	-	■	●●●	7.190
143	65	7	450	●	-	●	▲	○	-	■	●●●	7.200
56	10	3	200	●	-	●	▲■	○	-	●	●●●	7.224
67	30	3,8	280	●	-	●	▲■	○	-	●	●●●	7.236
91	48	4,5	300	●	-	●	▲■	○	-	●	●●●	7.248
91	60	6	400	●	-	●	▲■	○	-	●	●●●	7.268
91	48	4,5	> 350	●	-	●	▲■	○	-	●	●●●	7.260
91	60	6	> 500	●	-	●	▲■	○	-	●	●●●	7.280
56	10	3	200	●	-	●	▲■	○	-	●	●●●	7.224
67	30	3,8	280	●	-	●	▲■	○	-	●	●●●	7.236
91	48	4,5	300	●	-	●	▲■	○	-	●	●●●	7.248
91	60	6	400	●	-	●	▲■	○	-	●	●●●	7.268
56	10	3	200	●	-	●	▲■	○	-	●	●●●	7.224
67	30	3,8	280	●	-	●	▲■	○	-	●	●●●	7.236
91	48	4,5	300	●	-	●	▲■	○	-	●	●●●	7.248
91	60	6	400	●	-	●	▲■	○	-	●	●●●	7.268
91	48	4,5	> 350	●	-	●	▲■	○	-	●	●●●	7.260
91	60	6	> 500	●	-	●	▲■	○	-	●	●●●	7.280

Technical Details | System E3 | T3 | E6

Legend

- Standard
- Suitable to a limited extent
- ▲ Options
- Especially suitable
- * In preparation / on request

Opening principle



Series / Product

Inner height hi [mm] +
ø cable max.



Inner width Bi [mm]
from - to



Outer height ha [mm]



Outer width Ba [mm]
from - to



Bending radius R [mm]
from - to



E3 - 3-piece E-Chain®, small, high dynamics - smooth and low noise

E3 E-Chain®, zip open lids



Series / Product	Inner height hi [mm] + ø cable max.	Inner width Bi [mm] from - to	Outer height ha [mm]	Outer width Ba [mm] from - to	Bending radius R [mm] from - to
E3.10	10	ø 8	20 - 60	15	32 - 72
E3.15	15	ø 13	20 - 60	20	32 - 72
E3.22	22	ø 20	20 - 60	27	32 - 72

T3 - 3-piece E-Chain® - very light weight and quiet

T3 E-Chain®, to open from both sides



Series / Product	Inner height hi [mm] + ø cable max.	Inner width Bi [mm] from - to	Outer height ha [mm]	Outer width Ba [mm] from - to	Bending radius R [mm] from - to
T3.29	29	ø 25	30 - 120	35	55 - 145

E6 - 6-piece E-Chain® - for extremely low-noise operations

E6 E-Chain®, crossbars every other link















Series / Product	Inner height hi [mm] + ø cable max.	Inner width Bi [mm] from - to	Outer height ha [mm]	Outer width Ba [mm] from - to	Bending radius R [mm] from - to
E6.29	29	ø 25	30 - 120	35	46 - 136
E6.35	35	ø 31	30 - 120	42	50 - 140
E6.40	40	ø 36	40 - 300	54	60 - 320
E6.52	52	ø 46	40 - 300	65	64 - 324
E6.62	62	ø 54	50 - 400	84	86 - 436
E6.80L	80	ø 72	112 - 550	108	140 - 578
E6.80	80	ø 72	50 - 600	108	100 - 650

E6 E-Tube - fully enclosed



Series / Product	Inner height hi [mm] + ø cable max.	Inner width Bi [mm] from - to	Outer height ha [mm]	Outer width Ba [mm] from - to	Bending radius R [mm] from - to
R6.29	28	ø 25	30 - 120	35	46 - 136
R6.40	40	ø 36	62	54	82
R6.52	52	ø 46	50 - 175	65	74 - 199

Pitch [mm]	Unsupported fill weight max [kg/m]	Unsupported length FL_B max [m]	Long travel max [m]	Interior separation possibilities			ESD/ATEX 	Cleanroom 	UL-V2 	Low noise 	Price index 	Page
				Separators 	Full-width shelves 	Shelves 						
												
16,7	0,3	0,75	-	●	-	-	▲	■	▲	■	●●●	8.10
16,7	0,7	0,9	-	●	▲	-	▲	■	▲	■	●●●	8.14
16,7	0,85	1,2	-	●	▲	-	▲	■	▲	■	●●●	8.18
15	1	1,45	-	●	●	●	▲	■	▲	■	●●●	8.28
22	3	1,75	-	●	●	●	▲	■	▲	■	●●●	8.40
25	6	1,9	-	●	●	●	▲	■	▲	■	●●●	8.50
27,8	10	2,75	60°	●	●	●	▲	■	▲	■	●●●	8.56
30	15	3	80°	●	●	●	▲	■	▲	■	●●●	8.66
50	43	4	100°	●	●	●	▲	■	▲	■	●●●	8.76
65	25	2,5	-	●	-	●	▲	■	▲	■	●●●	8.82
65	55	5,25	120°	●	-	●	▲	■	▲	■	●●●	8.88
22	3	1,75	-	●	-	-	▲	■	▲	■	●●●	8.46
27,8	10	2,75	60°	●	-	-	▲	■	▲	■	●●●	8.62
30	15	3	80°	●	-	-	▲	■	▲	■	●●●	8.72
			*upon request									

Technical Details | Classic Series

Legend

- Standard
- Suitable to a limited extent
- ▲ Options
- Especially suitable
- * In preparation / on request

Opening principle



Series / Product

Inner height
 hi [mm] +
ø cable max.



Inner width
 Bi [mm] from - to



Outer height
 ha [mm]



Outer width
 Ba [mm] from - to



Bending radius
 R [mm] from - to



E2 medium Classic - For new designs we recommend E2/000

E2 medium, closed design

		200 Classic	25	ø 23	25 - 125	35	41 - 141	55 - 250	
		26 Classic	35	ø 32	50 - 200	50	66 - 219	63 - 250	

E2 medium, snap-open along inner radius

		240 Classic	25	ø 23	25 - 125	35	41 - 141	55 - 250	
		27i Classic	35	ø 32	50 - 200	50	66 - 219	63 - 250	
		340 Classic	45	ø 42	50 - 250	64	70 - 270	75 - 300	

E2 medium, snap-open along outer radius

		250 Classic	25	ø 23	25 - 125	35	41 - 141	55 - 250	
		27 Classic	35	ø 32	50 - 200	50	66 - 219	63 - 250	
		350 Classic	45	ø 42	50 - 250	64	70 - 270	75 - 300	

Line extensions and special solutions

Version with increased inner height - based on Series 380 and 3838









		38022 E4/00	52	ø 48	50 - 400	64	76 - 426	75 - 350	
		383822 E4/4	52	ø 48	50 - 400	64	77 - 427	75 - 350	

E-Band - split crossbar along the outer radius

		E-Band	25,5	ø 22	25	36	36	45 - 200	

Selection table - Classics online-program

Series	Product	Inner height		Outer width	Outer height	Radius		Unsupported length max. [m]	Internet Link
		hi [mm]	Bi [mm]			Ba [mm]	R [mm]		
15 classic	Zipper	17	15 - 50	26 - 61	24	38 - 180	1,2	www.igus.de/en/15s	
10 classic	E2 mini	18	15 - 50	26 - 61	23	28 - 180	1,2	www.igus.de/en/10s	
B15 classic	E2 mini	17	15 - 50	26 - 61	24	38 - 180	1,2	www.igus.de/en/B15s	
20/25	E2 medium	25	11 - 103	27 - 118	34	55 - 250	2	www.igus.de/en/20	
30/35/36	E2 medium	45	75 - 175	93 - 195	64	75 - 300	2,5	www.igus.de/en/30	
R58 classic	E2 Tubes	35	50 - 75	66 - 92	50	75 - 250	2,3	www.igus.de/en/r58s	
R68 classic	E2 Tubes	45	75 - 175	93 - 196	64	100 - 300	2,5	www.igus.de/en/r68s	
140/141/R188	E4/light	56	50 - 600	76 - 626	84	135 - 500	4	www.igus.de/en/140	
142/143	E4/light	62	50 - 400	76 - 426	84	135 - 500	4	www.igus.de/en/142	
150/151/R198	E4/light	80	50 - 600	80 - 630	108	150 - 500	4,5	www.igus.de/en/150	
22/23/R76	E4/0	28	40 - 300	60 - 320	42	55 - 250	2,1	www.igus.de/en/22	
28/29/R77	E4/0	32	50 - 400	73 - 423	54	63 - 300	2,5	www.igus.de/en/28	
38/39/R78	E4/0	42	50 - 400	77 - 427	64	75 - 350	3,25	www.igus.de/en/38	
40/41/R88	E4/0	56	50 - 600	86 - 636	84	135 - 500	4,5	www.igus.de/en/40	
50/51/R98	E4/0	80	50 - 600	100 - 650	108	150 - 1000	6	www.igus.de/en/50	

Pitch [mm]	Unsupported fill weight max [kg/m]	Unsupported length FL_B max [m]	Long travel max [m]	Interior separation possibilities			ESD/ATEX 	Cleanroom 	UL-V2 	Low noise 	Price index 	Page
				Separators 	Full-width shelves 	Shelves 						
46	4	2	100	●	●	●	-	-	-	-	●●●	12.4
56	8	2,2	120	●	●	●	-	-	-	-	●●●	12.6
46	4	2	100	●	●	●	-	-	-	-	●●●	12.4
56	8	2,2	120	●	●	●	-	-	-	-	●●●	12.6
67	10	2,5	150	●	●	●	-	-	-	-	●●●	12.8
46	4	2	100	●	●	●	-	-	-	-	●●●	12.4
56	8	2,2	120	●	●	●	-	-	-	-	●●●	12.6
67	10	2,5	150	●	●	●	-	-	-	-	●●●	12.8
67	30	3,8	300	●	-	●	▲	○	-	■	●●●	12.12
67	30	3,8	280	●	-	●	▲■	○	-	●	●●●	12.14
25	1,5	1,5	-	-	-	-	▲	●	-	●	●●●	12.18

Recommended, new Series	Page
15	4.18
10	5.48
B15	5.70
2400	5.102
3400	5.126
R58	6.34
R68	6.42
14040	7.124
14240	7.134
15050	7.144
E4.28	7.24
E4.32	7.34
E4.42	7.48
E4.56	7.62
E4.80	7.76



You miss a classic series in this catalog? At www.igus.eu/classics you will find all igus® Classic series. There you can download the entire PDF-catalogue.

For a printed catalogue please call us: +49 (0) 2203/9649-800 - Thank you!

- Legend of materials**
- Aluminium, seawater-resistant
 - Galvanized steel
 - Stainless steel upon request
 - ▲ Galvanized steel/polymer

Series / Product	Outer height Trough side part [mm]	Series Zipper	Series E2 mini	Series E2/000 <small>*Conditionally suitable in inner radii</small>	Series E2 E-Tubes
------------------	------------------------------------	---------------	----------------	--	-------------------



Super-alu-trough, basic version - for general machinery

	970.30.SL / 970.31.SL	77	15/R15	10/B15	-	-	
	970.30.SL / 970.32.SL	77	-	-	1400/1450/1480/1500	-	
	971.30.SL / 971.31.SL	87	-	-	2400*/2450*/2480*/2500/255	R48	
	972.02.30.SL / 972.02.31.SL	117	-	-	-	-	
	972.30.SL / 972.31.SL	117	-	-	-	-	
	972.30.SL / 972.32.SL	117	-	-	2600/2650/2680*/2700	R58	
	973.30.SL / 973.31.SL	144	-	-	3400/3450/3480*/3500	R68	
	974.30.SL / 974.31.SL	184	-	-	-	-	
	975.30.SL / 975.31.SL	236	-	-	-	-	
	HD-version						
	974.30.SL / 974.31.SL	184	-	-	-	-	
	975.30.SL / 975.31.SL	236	-	-	-	-	

Specialty: Steel guide trough - for harsh environments

	92.30 / 92.31	70	-	-	2400*/2450*/2480*/2500/255	-	
	95.30 / 95.31	100	-	-	2600/2650/2680*/2700	R58	
	99.30 / 99.31	100	-	-	-	-	
	97.30 / 97.31	130	-	-	-	-	
	93.30 / 93.31	130	-	-	3400/3450/3480*/3500	R68	
	94.30 / 94.31	170	-	-	-	-	
	96.30 / 96.31	220	-	-	-	-	
	98.30 / 98.31	300	-	-	-	-	
	90.30 / 90.31	480	-	-	-	-	
	One-piece trough						
	91.10 - 91.71	48	15/R15	10/B15	-	-	

Specialty: Tubular trough system RS - lets light and chips through

	92.70 / 92.71	90	-	-	2400*/2450*/2480*/2500/255	-
	93.70 / 93.71	146	-	-	3400/3450/3480*/3500	-
	95.70 / 95.71	126,3	-	-	2600/2650/2680*/2700	-

Specialty: Snap-in trough system SP - simple and cost effective

	91.930	55,5	15	10/B15	-	-
	92.930	76,6	-	-	2400*/2450*/2480*/2500	-
	93.930	138,6	-	-	3400/3450/3480*/3500	-
	95.930	106,6	-	-	2600/2650/2680*/2700	-

System E4.1	System E4/light	System E4/00	System E4/4	System E6 *nach Rücksprache	Material of side parts (see legend)	Price index ● ● ●	Page
E4.21*	-	-	210*	-	-	● ● ● ●	9.20
-	-	-	-	-	E6.29/R6.29	● ● ● ●	9.22
E4.28/R4.28	-	-	220/R760	-	E6.35	● ● ● ●	9.24
E4.32/H4.32/R4.32	-	-	280/290/R770	2828/2928/R7728	E6.40/R6.40	● ● ● ●	9.26
-	-	-	-	-	-	● ● ● ●	9.28
E4.42/H4.42/R4.42	-	-	380/390/R780	3838/3938/R7838	E6.52/R6.52	● ● ● ●	9.30
E4.56/H4.456/R4.56	14040/14140/R18840/14240/14340	400/410/R880	4040/4140/R8840	E6.62	-	● ● ● ●	9.32
E4.80/H4.80/R4.80	15050/15150/R19850	-	5050/5150/R9850	E6.80	-	● ● ● ●	9.34
-	-	-	-	-	-	-	9.36
-	-	-	4040HD/R8840HD	-	-	● ● ● ●	9.38
-	-	-	5050HD/R9850HD	-	-	● ● ● ●	9.40
-	-	-	-	-	E6.29/R6.29	○ ■ ● ● ●	9.44
-	-	-	-	-	-	○ ■ ● ● ●	9.46
E4.28/R4.28	-	-	220/R760	-	E6.35	○ ■ ● ● ●	9.48
E4.32/H4.32/R4.32	-	-	280/290/R770	2828/2928/R7728	E6.40/R6.40	○ ■ ● ● ●	9.50
E4.42/H4.42/R4.42	-	-	380/390/R780	3838/3938/R7838	E6.52/R6.52	○ ■ ● ● ●	9.52
E4.56/H4.456/R4.56	14040/14140/14240/14340/R18840	400/410/R880	4040/4140/R8840	E6.62	-	○ ■ ● ● ●	9.54
E4.80/H4.80	15050/15150/R19850	-	5050/5150/R9850	E6.80	-	○ ■ ● ● ●	9.56
-	1640/R1608	600/601/R608/640	-	-	-	○ ■ ● ● ●	9.58
-	800/840	-	-	-	-	○ ■ ● ● ●	9.60
-	-	-	-	-	-	○ ■ ● ● ●	9.63
-	-	-	-	-	E6.29/R6.29	▲ ● ● ● ●	9.66
-	-	-	-	-	E6.52/R6.52**	▲ ● ● ● ●	9.67
-	-	-	-	-	-	▲ ● ● ● ●	9.67
					** without distance plate		
-	-	-	-	-	-	○ ■ ● ● ●	9.68
-	-	-	-	-	E6.29/R6.29**	○ ■ ● ● ●	9.68
-	-	-	-	-	E6.52/R6.52	○ ■ ● ● ●	9.69
-	-	-	-	-	-	○ ■ ● ● ●	9.69
					** without distance plate		

Legend of materials

- Aluminium, seawater-resistant
- Galvanized steel
- Stainless steel upon request
- ▲ Galvanized steel/polymer

Description

System P4 Rol E-Chain® - energy efficient on long travels



Safe, maintenance-free energy supply system on long travels up to 800 m and more for outdoor cranes or conveyor systems. Energy efficient polymer E-Chains® and cables reduce consumption by up to 60%. With the right materials and clever design, the energy consumption can be drastically reduced.

Rol E-Chain® - Rolling instead of gliding



Reduction of driving power down to 25% to move the E-Chain®. For very long travels with high fill weights. Due to the rolls, the friction coefficient of the system is very low - save money and energy.

AUTO-GLIDE - Long travels without guide troughs



AUTO-GLIDE - special solutions for long travels without trough guides.

Guidelok horizontal - upper run support, unsupported up to 50m



Upper run guide for long travels, self-supporting in chip areas. Unsupported travels up to 50 m are possible. Chips cannot get stuck between upper and lower run. Modular system with few parts.

New in this catalog!

Guidelok vertical - For vertical energy supplies up to heights of 80 m



For vertical applications with lateral motion, igus® Guidelok offers a simple, costeffective and safe system solution! Keeps hanging E-Chains in line - no swinging sideways. No bouncing of E-Chains® in vertical applications with horizontal dynamics. For high speed, acceleration and noise reduction.

LBT Flizz® - Enclosed plastic trough



In its entirety, this system encompasses the igus® Energy Chain®, LBT Flizz® guide trough and - as an option - fully configured igus® Chainflex® cables. The LBT Flizz® guide trough is a modular kit comprising extruded guide profiles and a supporting frame with continuous tubes providing stabilization.

Micro Flizz® - Small E-Chains® in aluminum profile



Compact, cost-saving complete system for safe guidance of energy, data and air. Maintenance-free alternative for power bar.

LeviChain - magnetic E-ChainSystem®, floating, gliding



Long travel possible without laying the E-ChainSystems® on top of each other. Almost no abrasion and very low wear due to low-abrasion E-Chain® links (without pin/hole connection) as well as almost contactless movement of the E-Chain®

New in this catalog!



For support of the lower run - Support tray

Simple one-piece support trays for the lower E-Chain® run, according with your requirements and specification. Your width, height and color - we supply the fitting E-Chain®, together with the support tray system. Ready to install onto your machine or application. Save on procurement and design time. ► **page 9.70**

Typical industries
and applicationsTravel
max. [m]Travel speed
max. [m/s]Inner heights
[mm]Price
index

Page

- Indoor-/Outdoor-applications ● Cranes ● Plant engineering
- Construction machinery ● Steelwork ● Applications with very long travels and speeds ● For harsh environments and high fill weights

≈ 800

≈ 10

32 - 80 mm

● ● ●

9.78

- Outdoor applications ● cranes ● mining industry ● road building ● steel plants ● all applications with long travels, rough environments and high fill weights

≈ 400 - 800

≈ 6

32 - 80 mm

● ● ●

9.86

- Indoor-/Outdoor-applications ● cranes ● storage and retrieval machines ● industrial trucks

≈ 50

≈ 1,5

21 - 80 mm
(4 options)

● ● ●

9.90

- Machine tools ● Applications in the chip area
- Wherever a gliding application is not recommended

≈ 50

≈ 2

56 mm

● ● ●

9.96

- Automated storage/retrieval systems ● Lifts ● Revolving storage systems ● Diagonal lifts ● All vertical applications

≈ 80

≈ 3

25 mm

● ● ●

9.98

- Sewage treatment plants ● rainwater overflow basins ● galvanic equipment ● cranes

≈ 200

≈ 8

24 mm
(In use of E-Chain®
Series 255)

● ● ●

9.100

- Indoor-cranes ● storage and retrieval machines ● industry gates ● control panels ● studio equipment (lighting)

Available standard lengths:
2m, 3m, 6m. Any number
of troughs possible. Special
lengths upon request

≈ 6

11/13 mm

(Inner height of the
applied E-Chain®)

● ● ●

9.104

- Cleanrooms ● Painting works/plants ● Medical technology
- Measuring technology ● Electronic manufacturing ● Automated storage and retrieval systems ● Material handling ● Industrial robots

≈ 40

25,5 mm

● ● ●







9.112

 igus® modular system for projects - fast, all ex-stock

Special components, tested and approved in numerous projects, have now become available as a modular standard system. ● Faster quotations ● Faster project planning ● Detailed service manuals and documentation

- Time and cost savings ● Safe function ► page 9.116

Technical Details | Chainfix strain relief

igus® Strain relief	Product	Ø [mm] from - to	Page
Chainfix clamps and stainless-steel* clamps - maximum pull forces			
	Single clamp housing, including top/bottom saddle clamps	6 - 42	10.5
	Double clamp housing, incl. top/bottom saddle clamps and 1 stacker saddle clamp	6 - 34	10.5
	Triple clamp housing, incl. top/bottom saddle clamps and 2 stacker saddle clamp	6 - 22	10.5
	Chainfix Multi clamps*	6 - 12	10.6
	<small>*Standard material: galvanized steel. Also available as stainless steel version (Material stainless steel: 1.4301)</small>		
Tiewrap plates - for cable tiewrap universal, bolted or clip-on			
	Option 1: Chainfix tiewrap plates as individual parts Series 2000 and 3000		10.8
	Cable tiewraps		10.8
Chainfix-tiewrap plates - for strain relief with cable tiewraps for C-profile			
	Option 2: tiewrap plates with clip-on connection for the C-profile		10.9
	Option 3: clip-on tiewrap plates for opening or fixed crossbars		10.9
	Option 4: integrated strain relief for E2 Tubes - Series R		10.9
	Chainfix testresults		10.7
Chainfix Clip - high pull forces, plug-in			
	Available for all igus® E-ChainSystems with C-profiles and also suitable for assembly in the KMA mounting brackets and Clip-on strain relief for crossbars	4 -24	10.10
Chainfix nuggets - for top hat rail and C-profile			
	Option 1: completely simple and universal cable fixation, for diameter with Ø 20 mm and Ø 30 mm	≤ ø 30	10.10
	Option 2: Fastening by clipping onto standard top hat rail	≤ ø 20	10.10
Strain relief separator with integrated teeth			
	Separator with integrated strain relief teeth- easy strain relief with cable tiewrap		10.11
igus® blocks			
	Blocks - special strain relief for hoses. A modular, space-saving system.		10.11

PMAFLEX conduits - cable protection



PACO	Flexible, medium, divisible	11.4
TN	Divisible connectors, PG	11.4
GTN	Divisible lock nuts, PG	11.4
PCL	Very flexible, medium	11.5
VOH	Pliable, very heavy	11.5
PIS/PIH	Highly flexible, medium	11.6
CYL	Very flexible, medium	11.7

PMAFIX connectors - safety and sealing systems



IP66 - stat., IP54 dyn.	Universal safety clip	11.8
IP68 - stat., IP67 dyn.	Oval clip	11.8
PMAFIX	Connectors	11.9
PMAFIX Anschlüsse VW	90° elbow, metric & PG	11.10
PMAFIX Anschlüsse VN	Straight, metric & PG	11.11
PMAFIX Anschlüsse VA	45° elbow, metric & PG	11.12
PMAFIX Anschlüsse VB	90° curved elbow, metric & PG	11.13
PMAFIX Anschlüsse VO	Flange 90°	11.13

PMA - accessories



PMAFIX FH0	One-piece system support	11.14
PMA MN	Hexagonal Lock Nuts, metric & PG	11.14
PMA SGB	Tube clamps	11.15
PMA 514	Plug Screws, metric & PG	11.15

Selection by inner heights



hi [mm]	Serie	Product	Chap.	Page	hi [mm]	Serie	Product	Chap.	Page
5 - 10 mm					24 - 29 mm				
5	03	E2 micro	5	5.10	24	255	E2 medium	5	5.138
5	E03	Easy Chain®	3	3.6	24,3	E200	Easy Chain®	3	3.36
7	04	E2 micro	5	5.14	24,3	E200.2	Easy Chain®	3	3.36
7	E04	Easy Chain®	3	3.10	24,3	Z200	Easy Chain®	3	3.36
9	047	Zipper	4	4.6	24,3	Z200.2	Easy Chain®	3	3.36
9,4	E045	Easy Chain®	3	3.14	25	2400	E2/000	5	5.102
9,4	Z045	Easy Chain®	3	3.14	25	2450	E2/000	5	5.102
10	05	E2 micro	5	5.22	25	2480	E2/000 E-Tube	5	5.102
10	E1.10	E1	3	3.64	25	2500	E2/000	5	5.102
10	E3.10	E3	8	8.10	25	R48	E2 E-Tube R	6	6.26
10,3 - 15 mm					32 - 35 mm				
10,3	07	Zipper	4	4.10	25,5	E-Band		12	12.12
10,3	B07	E2 micro	5	5.30	28	220*	E4/00	7	7.162
10,3	045	E2 micro	5	5.18	28	11.080	E2 mini	5	5.58
10,3	R07	Zipper E-Tube	4	4.28	28	E4.28/R4.28	E4.1	7	7.24
10,5	06	E2 micro	5	5.26	28	R6.29	E6 E-Tube	8	8.46
10,5	Z06	Easy Chain®	3	3.20	28	R760*	E4/00 E-Tube	7	7.162
10,7	E06	Easy Chain®	3	3.20	29	E6.29	E6	8	8.40
11,3	E065	Easy Chain®	3	3.24	29	T3.29	T3	8	8.28
14,3	B09	E2 micro	5	5.38	32 - 35 mm				
14,6	E08	Easy Chain®	3	3.28	32	17	Zipper	4	4.24
14,7	Z08	Easy Chain®	3	3.28	32	280*	E4/00	7	7.170
15	08	E2 micro	5	5.34	32	290*	E4/00	7	7.170
15	09	Zipper	4	4.14	32	2828*	E4/4	7	7.224
15	E3.15	E3	8	8.14	32	2928*	E4/4	7	7.224
15	R09	Zipper E-Tube	4	4.32	32	B17	E2 mini	5	5.76
17 - 23 mm					32	B17i	E2 mini	5	5.76
17	15	Zipper	4	4.18	32	E16	Easy Chain®	3	3.42
17	R15	Zipper E-Tube	4	4.36	32	E4./H4./R4.32	E4.1	7	7.34
17	B15	E2 mini	5	5.70	32	P4.32	P4	9	9.82
17	B15i	E2 mini	5	5.70	32	F17	E2 mini	5	5.82
17	E1.17	E1	3	3.64	32	R17	Zipper E-Tube	4	4.42
18	10	E2 mini	5	5.48	32	R770*	E4/00 E-Tube	7	7.170
18	TE/TZ14	SnapChain	3	3.66	32	R7728*	E4/4 E-Tube	7	7.224
19	E14	Easy Chain®	3	3.32	32	Z16	Easy Chain®	3	3.42
19	Z14	Easy Chain®	3	3.32	35	2600	E2/000	5	5.114
20	14	E2 mini	5	5.66	35	2650	E2/000	5	5.114
20	E1.20	E1	3	3.64	35	2680	E2/000 E-Tube	5	5.114
21	210**	E4/00	7	7.16	35	2700	E2/000	5	5.114
21	1400	E2/000	5	5.92	35	E6.35	E6	8	8.50
21	1450	E2/000	5	5.92	35	R58	E2 E-Tube R	6	6.34
21	1480	E2/000 E-Tube	5	5.92	36,5 - 48,5 mm				
21	1500	E2/000	5	5.92	36,5	E26	Easy Chain®	3	3.46
21	E4.21**	E4.1	7	7.16	36,5	Z26	Easy Chain®	3	3.46
21	R117	E2 E-Tube R100	6	6.6	37,1	E26.2	Easy Chain®	3	3.46
21	R118	E2 E-Tube R100	6	6.6	37,1	E26.3	Easy Chain®	3	3.46
22	E3.22	E3	8	8.18	37,1	Z26.2	Easy Chain®	3	3.46
23	11.031	E2 mini	5	5.54	37,1	Z26.3	Easy Chain®	3	3.46
					40	E6.40	E6	8	8.56
					40	R157	E2 E-Tube R100	6	6.12
					40	R158	E2 E-Tube R100	6	6.12

*For new designs we recommend E4.1! **Series E4.21 is structurally identical to Series 210 and will replace them

hi [mm]	Serie	Product	Chap.	Page
36,5 - 48,5 mm				
40	R6.40	E6 E-Tube	8	8.62
41	11.1/11.2	E2 mini	5	5.62
42	380*	E4/00	7	7.180
42	390*	E4/00	7	7.180
42	3838*	E4/4	7	7.236
42	3938*	E4/4	7	7.236
42	E4./H4./R4.42	E4.1	7	7.48
42	P4.42	P4	9	9.83
42	R780	E4/00 E-Tube	7	7.180
42	R7838*	E4/4 E-Tube	7	7.236
45	3400	E2/000	5	5.126
45	3450	E2/000	5	5.126
45	3480	E2/000 E-Tube	5	5.126
45	3500	E2/000	5	5.126
45	R68	E2 E-Tube R	6	6.42
47	TE/TZ26	SnapChain	3	3.66
48,5	E300	Easy Chain®	3	3.52
48,5	E300.2	Easy Chain®	3	3.52
48,5	E300.3	Easy Chain®	3	3.52
48,5	Z300	Easy Chain®	3	3.52
48,5	Z300.2	Easy Chain®	3	3.52
48,5	Z300.3	Easy Chain®	3	3.52
50 - 56 mm				
50	R167	E2 E-Tube R100	6	6.20
50	R168	E2 E-Tube R100	6	6.20
52	38022	E4/00	12	12.12
52	383822	E4/4	12	12.14
52	E6.52	E6	8	8.66
52	R6.52	E6 E-Tube	8	8.72
52	RX40	RX E-Tube	6	6.54
56	400*	E4/00	7	7.190
56	410*	E4/00	7	7.190
56	4040*	E4/4	7	7.248
56	4140*	E4/4	7	7.248
56	14040	E4/light	7	7.124
56	14140	E4/light	7	7.124
56	4040HD	E4/4 HD	7	7.260
56	E4./H4./R4.56	E4.1	7	7.62
56	P4.56	P4	9	9.84
56	R18840	E4/light E-Tube	7	7.124
56	R880*	E4/00 E-Tube	7	7.190
56	R8840 *	E4/4 E-Tube	7	7.248
56	R8840HD	E4/4 HD E-Tube	7	7.260
62 - 80 mm				
62	14240	E4/light	7	7.134
62	14340	E4/light	7	7.134
62	E6.62	E6	8	8.76
80	5050*	E4/4	7	7.268
80	5150*	E4/4	7	7.268
80	15050	E4/light	7	7.144

hi [mm]	Serie	Product	Chap.	Page
62 - 80 mm				
80	15150	E4/light	7	7.144
80	5050HD	E4/4 HD	7	7.280
80	E6.80	E6	8	8.88
80	E6.80L	E6 light	8	8.82
80	E4./H4./R4.80	E4.1	7	7.76
80	P4.80	P4	9	9.85
80	R19850	E4/light E-Tube	7	7.144
80	R9850*	E4/4 E-Tube	7	7.268
80	R9850HD	E4/4 HD E-Tube	7	7.280
108 - 350 mm				
108	600	E4/00	7	7.200
108	601	E4/00	7	7.200
108	R608	E4/00 E-Tube	7	7.200
112	640	E4/00	7	7.208
112	1640	E4.1	7	7.90
112	R1608	E4.1 E-Tube	7	7.90
200	800	E4.1	7	7.100
204	840	E4.1	7	7.106
350	E4.350	E4.1	7	7.112
3D E-Chains®				
max. 12	TRC/TRE/TRL.30	Triflex® R	2	2.4
□ 16	332.16	Triflex®	2	2.48
	333.16	Triflex®	2	2.48
2 x 13	E332.25	Easy Triflex®	2	2.36
	E333.25	Easy Triflex®	2	2.36
max. 15	TRC/TRE/TRL.40	Triflex® R	2	2.4
□ 32	332.32	Triflex®	2	2.48
	333.32	Triflex®	2	2.48
2 x 17	E332.32	Easy Triflex®	2	2.36
	E333.32	Easy Triflex®	2	2.36
max. 22,5	TRC/TRE/TRL.60	Triflex® R	2	2.4
max. 28	TRC/TRE/TRL.70	Triflex® R	2	2.4
2 x 26	E332.50	Easy Triflex®	2	2.36
	E333.50	Easy Triflex®	2	2.36
□ 50	332.50	Triflex®	2	2.48
	333.50	Triflex®	2	2.48
	352.50	Triflex®	2	2.48
	353.50	Triflex®	2	2.48
max. 33	TRC/TRE.85	Triflex® R	2	2.4
max. 37,5	TRC/TRE/TRL.100	Triflex® R	2	2.4
max. 43,3	TRC/TRE.125	Triflex® R	2	2.4
□ 75	332.75	Triflex®	2	2.48
	333.75	Triflex®	2	2.48
2 x 38,5	E332.75	Easy Triflex®	2	2.36
	E333.75	Easy Triflex®	2	2.36
Circular movements				
28	2208	TwisterChain®	2	2.62
32	2808	TwisterChain®	2	2.62
42	3808	TwisterChain®	2	2.62
56	4008	TwisterChain®	2	2.62

*For new designs we recommend E4.1! **Series E4.21 is structurally identical to Series 210 and will replace them

Selection by product, series and page

Series	Product	Page	Series	Product	Page	Series	Product	Page
03	E2 micro	5.10	2600	E2/000	5.114	410*	E4/00	7.190
04	E2 micro	5.14	2650	E2/000	5.114	4140*	E4/4	7.222
045	E2 micro	5.18	2680	E2/000	5.114	5050*	E4/4	7.268
047	Zipper	4.6	27	E2 medium	12.6	5050HD	E4/4	7.280
05	E2 micro	5.22	2700	E2/000	5.114	5050R	Rol E-Chain®	9.88
06	E2 micro	5.26	271	E2 medium	12.6	5050RHD	Rol E-Chain®	9.88
07	Zipper	4.10	280*	E4/00	7.170	5150*	E4/4	7.268
B07	E2 micro	5.30	2808	TwisterChain®	2.62	600	E4/00	7.200
08	E2 micro	5.34	2828*	E4/4	7.224	601	E4/00	7.200
09	Zipper	4.14	2828R	Rol E-Chain®	9.88	640	E4/00	7.208
B09	E2 micro	5.38	290*	E4/00	7.132	800	E4.1	7.100
10	E2 mini	5.48	2928*	E4/4	7.224	840	E4.1	7.106
11.031	E2 mini	5.54	332.16	Triflex®	2.48	AUTO-GLIDE		9.90
11.080	E2 mini	5.58	332.32	Triflex®	2.48	B15	E2 mini	5.70
11.1	E2 mini	5.62	332.50	Triflex®	2.48	B15i	E2 mini	5.70
11.2	E2 mini	5.62	332.75	Triflex®	2.48	B17	E2 mini	5.76
14	E2 mini	5.66	333.16	Triflex®	2.48	B17i	E2 mini	5.76
1400	E2/000	5.92	333.32	Triflex®	2.48	E03	Easy Chain®	3.6
14040	E4/light	7.124	333.50	Triflex®	2.48	E04	Easy Chain®	3.10
14140	E4/light	7.124	333.75	Triflex®	2.48	E045	Easy Chain®	3.14
14240	E4/light	7.134	340	E2 medium	12.8	E06	Easy Chain®	3.20
14340	E4/light	7.134	3400	E2/000	5.126	E065	Easy Chain®	3.24
1450	E2/000	5.92	3450	E2/000	5.126	E08	Easy Chain®	3.28
1480	E2/000	5.92	3480	E2/000	5.126	E1.10	E1	3.64
15	Zipper	4.18	350	E2 medium	12.8	E1.17	E1	3.64
1500	E2/000	5.92	3500	E2/000	5.126	E1.20	E1	3.64
15050	E4/light	7.144	352.50	Triflex®	2.48	E14	Easy Chain®	3.32
15150	E4/light	7.144	353.50	Triflex®	2.48	E16	Easy Chain®	3.42
1640	E4.1	7.90	380*	E4/00	7.180	E200	Easy Chain®	3.36
17	Zipper	4.24	3808	TwisterChain®	2.62	E26	Easy Chain®	3.46
200	E2 medium	12.4	3838*	E4/4	7.236	E3.10	E3	8.10
210**	E4/00	7.16	38022	E4/00	12.12	E3.15	E3	8.14
220*	E4/00	7.162	383822	E4/4	12.14	E3.22	E3	8.18
2208	TwisterChain®	2.62	3838R	Rol E-Chain®	9.88	E300	Easy Chain®	3.52
240	E2 medium	12.4	390*	E4/00	7.180	E332.25	Easy Triflex®	2.36
2400	E2/000	5.102	3938*	E4/4	7.236	E332.32	Easy Triflex®	2.36
2450	E2/000	5.102	400*	E4/00	7.190	E332.50	Easy Triflex®	2.36
2480	E2/000	5.102	4008	TwisterChain®	2.62	E332.75	Easy Triflex®	2.36
250	E2 medium	12.4	4040*	E4/4	7.248	E333.25	Easy Triflex®	2.36
2500	E2/000	5.102	4040HD	E4/4	7.260	E333.32	Easy Triflex®	2.36
255	E2 medium	5.138	4040R	Rol E-Chain®	9.88	E333.50	Easy Triflex®	2.36
26	E2 medium	12.6	4040RHD	Rol E-Chain®	9.88	E333.75	Easy Triflex®	2.36

*For new designs we recommend E4.11 **Series E4.21 is structurally identical to Series 210 and will replace them

Series	Product	Age
E4.21**	E4.1	7.16
E4.28	E4.1	7.24
E4.32	E4.1	7.34
E4.42	E4.1	7.48
E4.56	E4.1	7.62
E4.80	E4.1	7.76
E4.350	E4.1	7.112
E6.29	E6	8.40
E6.35	E6	8.50
E6.40	E6	8.56
E6.52	E6	8.66
E6.62	E6	8.76
E6.80	E6	8.88
E6.80L	E6	8.82
E-Bhd		12.12
F7	E2 mini	5.82
Guidelok horizontal		9.96
Guidelok vertical		9.98
#32	E4.1	7.34
#42	E4.1	7.48
#56	E4.1	7.62
#80	E4.1	7.76
LBflizz [®]		9.100
LZ5	LeiChain	9.112
MB6	Micro Flizz [®]	9.107
MB8	Micro Flizz [®]	9.107
#32	P4	9.82
#42	P4	9.83
#56	P4	9.84
#80	P4	9.85
MA		11.2
Ø7	Zipper	4.28
Ø9	Zipper	4.32
R17	E2 Tubes R100	6.6
R18	E2 Tubes R100	6.6
R5	Zipper	4.36
R57	E2 Tubes R100	6.12
R58	E2 Tubes R100	6.12
R508	E4.1	7.90
R67	E2 Tubes R100	6.20
R68	E2 Tubes R100	6.20
R7	Zipper	4.42

Series	Product	Age	Se
R840	E4/light	7.124	
R850	E4/light	7.144	
#28	E4.1	7.24	
#32	E4.1	7.34	
#42	E4.1	7.48	
#56	E4.1	7.62	
#80	E4.1	7.76	
#8	E2 Tubes R	6.26	
#8	E2 Tubes R	6.34	
Ø29	E6	8.46	
Ø40	E6	8.62	
Ø52	E6	8.72	
Ø8*	E4/00	7.200	
Ø8	E2 Tubes R	6.42	
Ø60*	E4/00	7.162	
Ø70*	E4/00	7.170	
Ø728*	E4/4	7.224	
Ø728R	Roll E-Chain [®]	9.88	
Ø80*	E4/00	7.180	
Ø838*	E4/4	7.236	
Ø838R	Roll E-Chain [®]	9.88	
Ø80*	E4/00	7.190	
Ø840*	E4/4	7.248	
Ø840E	E4/4	7.260	
Ø840R	Roll E-Chain [®]	9.88	
Ø850*	E4/4	7.242	
Ø850E	E4/4	7.280	
Ø850R	Roll E-Chain [®]	9.88	
ØD	RX Tubes	6.56	
Steel trough		9.42	
Snap-in trough system SP		9.68	
Strain relief - Chainfix		10.2	
Super-alu-trough		9.12	
Support tray		9.70	
T3.29	T3	8.28	
TE14	SnapChain	3.66	
TE26	SnapChain	3.66	
TB.30	Triflex [®] R	2.12	
TB.40	Triflex [®] R	2.12	
TB.60	Triflex [®] R	2.12	
TB.70	Triflex [®] R	2.12	
TB.85	Triflex [®] R	2.12	

Series	Product	Age
TB.100	Triflex [®] R	2.12
TB.125	Triflex [®] R	2.12
TB.30	Triflex [®] R	2.14
TB.40	Triflex [®] R	2.14
TB.60	Triflex [®] R	2.14
TB.70	Triflex [®] R	2.14
TB.85	Triflex [®] R	2.14
TB.100	Triflex [®] R	2.14
TB.125	Triflex [®] R	2.14
TB.30	Triflex [®] R	2.16
TB.40	Triflex [®] R	2.16
TB.60	Triflex [®] R	2.16
TB.70	Triflex [®] R	2.16
TB.100	Triflex [®] R	2.16
Tubular trough system B		9.66
TZ14	SnapChain	3.66
TZ26	SnapChain	3.66
Z045	Easy Chain [®]	3.14
Z06	Easy Chain [®]	3.20
Z08	Easy Chain [®]	3.28
Z14	Easy Chain [®]	3.32
Z16	Easy Chain [®]	3.42
Z200	Easy Chain [®]	3.36
Z26	Easy Chain [®]	3.46
Z300	Easy Chain [®]	3.52

*For new designs we recommend E4.1! ** *Series E4.21 is structurally identical to Series 210 and will replace them

Contents

1 Design and calculation aids, applications, diagrams - harnessing

Introduction			
Designing with igus®	1.1	Side-mounted applications	1.24
igus® terms in alphabetical order	1.4	Rotary motion applications	1.26
Calculation of E-Chain®-lengths and camber	1.5	Cable and hose packages	1.28
Applications	1.6	Strain relief elements	1.32
Unsupported - short travel applications	1.8	Technical data and standards	
Unsupported - noise-optimized	1.11	ESD/ATEX	1.34
Load diagrams FL_G/FL_B	1.12	Cleanroom applications	1.36
Gliding - long travel applications	1.16	Technical environment	1.37
Vertical - hanging applications	1.20	Material data	1.38
"Zig-zag" - hanging applications	1.21	Chemical resistance and colors	1.39
Vertical - standing applications	1.22	Certificates	1.40
		ReadyChain®	1.41

2 Triflex® R, Easy Triflex®, Triflex®, TwisterChain®

Triflex® R	2.4	Easy Triflex®	2.30	332/333/352/353	2.48	3808	2.62
Assembly	2.9 - 2.11	Assembly	2.35	TwisterChain®	2.56	4008	2.62
TRC	2.12	E332/E333	2.36	Assembly	2.61		
TRE	2.14	Triflex®	2.42	2208	2.62		
TRL	2.16	Assembly	2.47	2808	2.62		

3 Easy Chain®, System E1 and Snapchain

Easy Chain®	3.0	E06/Z06	3.20	E16/Z16	3.42	E1.10	3.64
Assembly	3.5	E065	3.24	E26/Z26	3.46	E1.17	3.64
E03	3.6	E08/Z08	3.28	E300/Z300	3.52	E1.20	3.64
E04	3.10	E14/Z14	3.32	E1	3.58	SnapChain	3.66
E045/Z045	3.14	E200/Z200	3.36	Assembly	3.63	TE/TZ	3.68

4 Zipper zip-open E-Chains® and zip-open E-Tubes

Zipper	4.0	07	4.10	17	4.24	R15	4.36
Assembly	4.5	09	4.14	R07	4.28	R17	4.42
047	4.6	15	4.18	R09	4.32		

5 System E2 micro, mini and E2/000

E2 micro	5.4	08	5.34	14	5.66	2400/2500	5.102
Assembly	5.9	B09	5.38	B15/B15i	5.70	2450/2480	5.102
03	5.10	E2 mini	5.42	B17/B17i	5.76	2600/2700	5.114
04	5.14	Assembly	5.47	F17	5.82	2650/2680	5.114
045	5.18	10	5.48	E2/000	5.86	3400/3500	5.126
05	5.22	11.031	5.54	Assembly	5.91	3450/3480	5.126
06	5.26	11.080	5.58	1400/1500	5.92	255	5.138
B07	5.30	11.1/11.2	5.62	1450/1480	5.92		

6 E-Tubes Series R100, Series R and RX

R100 / R	6.2	R157/R158	6.12	R58	6.34	RX	6.50
Assembly	6.5	R167/R168	6.20	R68	6.42	Assembly	6.55
R117/R118	6.6	R48	6.26			RX40	6.56

7 System E4 - E4.1, E4/light, E4/00, E4/4,

E4.1	7.6	E4.56/H4.56/R4.56	7.62	14040/14140/R18840	7.124	3838/3938/R7838*	7.236
Assembly	7.15	Interior		14240/14340	7.134	4040/4140/R8840*	7.248
		separation kit	7.66	15050/15150/R19850	7.144	4040HD/R8840HD	7.260
Order key	7.22	Order key	7.74	E4/00	7.156	5050/5150/R9850*	7.268
E4.28/R4.28	7.24	E4.80/H4.80/R4.80	7.76	Assembly	7.161	5050HD/R9850HD	7.280
Order key	7.32	Interior		220/R760*	7.162		
E4.32/H4.32/R4.32	7.34	separation kit	7.80	280/290/R770*	7.170		
Interior		Order key	7.88	380/390/R780*	7.180		
separation kit	7.38	1640/R1608	7.90	400/410/R880*	7.190		
Order key	7.46	800	7.100	600/601/R608	7.200		
E4.42/H4.42/R4.42	7.48	840	7.106	640	7.208		
Interior		E4.350	7.112	E4/4	7.218		
separation kit	7.52	E4/light	7.118	Assembly	7.223		
Order key	7.60	Assembly	7.123	2828/2928/R7728*	7.224		

* For new designs we recommend E4.1!

** Series E4.21 is structurally identical to Series 210 and will replace them

8 System E3, T3 and System E6 - extremely low noise operation

E3	8.4	T3	8.22	E6.29	8.40	E6.52	8.66
Assembly	8.9	Assembly	8.27	R6.29	8.46	R6.52	8.72
E3.10	8.10	T3.29	8.28	E6.35	8.50	E6.62	8.76
E3.15	8.14	E6	8.34	E6.40	8.56	E6.80L	8.82
E3.22	8.18	Assembly	8.39	R6.40	8.62	E6.80	8.88

9 Guide troughs and special solutions for long travel applications

Super-alu-trough	9.12	Steel trough	9.42	91.10 - 91.51.	9.63	Special solutions	
Fixed end module alu. ..	9.16	92.30 / 92.31.	9.44	Tubular troughs RS	9.66	System P4	9.78
970.30/970.31.	9.20	95.30 / 95.31.	9.46	92.70 / 92.71.	9.66	Roll E-Chain®	9.86
970.30/970.32.	9.22	99.30 / 99.31.	9.48	93.70 / 93.71.	9.67	AUTO-GLIDE	9.90
971.30/971.31.	9.24	97.30 / 97.31.	9.50	95.70 / 95.71.	9.67	Guidelok horizontal	9.96
972.02.30/972.02.31.	9.26	93.30 / 93.31.	9.52	Snap-in trough SP	9.68	Guidelok vertical	9.98
972.30/972.31.	9.28	94.30 / 94.31.	9.54	91.930.	9.68	LBT Flizz®	9.100
972.30/972.32.	9.30	96.30 / 96.31.	9.56	92.930.	9.68	Micro Flizz®	9.104
973.30/973.31.	9.32	98.30 / 98.31.	9.58	93.930.	9.69	LeviChain	9.112
974.30/974.31.	9.34	90.30 / 90.31.	9.60	95.930.	9.69	Modular system	
975.30/975.31.	9.38	Fixed end module steel .	9.62	Support tray	9.70	for projects	9.116

10 igus® Chainfix strain relief

Chainfix clamps - steel	10.5	Clips	10.10
Chainfix clamps - stainless steel	10.5	Nuggets	10.10
Multi clamps	10.6	Strain relief separators	10.11
Universal tiewrap plates	10.8	Blocks	10.11
Tiewrap plates for C-profile	10.9		

12 Classic-Series, line extensions and special solutions

Classic-series	Line-extensions and	E-Band	12.18	Fax forms	12.58
200/240/250 E2 med.	special solutions	About igus®	12.20	Terminology index	12.64
26/27/27 E2 med.	38022 E4/00	igus® Applications	12.46	Selection guide	12.66
340/350 E2 med.	383822 E4/4	Appendix:		igus® addresses	12.68

Pictograms - E-ChainSystems®

Accessibility of E-Chains® and E-Tubes

	Cannot be opened		Can be opened from both sides
	Zipper principle: Zip to open		Snap-open along outer radius on left or right side
	Snap-open along inner radius		Snap-open along inner radius on left or right side
	Snap-open along outer radius		Can be opened from one side
	Easy Chain®-principle: simply press cables in		Can be opened from both sides and hinged open on one side

Pictograms

	Recommended Standard		igus®-Definition		Unsupported - short travels
	igus®-information		Preferred Series		Gliding - long travels
	igus® order examples		Part No key		Vertical hanging application
	igus® Web www.igus.eu		Temperature		Vertical standing application
	Weights		Acceleration / Speed		Side-mounted application
	Calculation		Torsional movements		Rotary motion application
	Low noise!		UL-Approval		Horizontal + vertical application
	ESD-Certificate		iF-Design Award		Nested application
	IPA-Cleanroom-Certificate		Other Clean-room-Certificate		Side by side application

Price index

	Low price category		Medium price category		Highest price category
--	--------------------	--	-----------------------	--	------------------------

Icon-bar

Series		80
Inner height [mm]		80
System		System E6 Inner height: 80 mm
Contact		Tel: +49- (0) 22 03-96 49-800 E-mail: info@igus.de
E-Chains®		
Interior separation		
Mounting bracket		
Strain relief		
Guide though		
Assembly instruction		
Page		d

Quicklinks

Quicklinks for more information and additional features on each page. "Visit" directly your chosen product online - for example ► www.igus.de/en/400 and you'll find more details, 3D-CAD-files, DXF-files, PDF-downloads, application examples and many more for your chosen igus® product.



Selection guide - designing E-Chains®

1

Dimensioning E-Chains®

Determine the size of the E-Chain® based on the specified installation space of your machine and/or of the selected filling (such as the number of cables/outer diameter of cable).

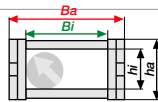

2

Determine fill weight

Determine fill weight of (cables and/or media hoses) in [kg/m] using Chainflex® Quick Selection or manufacturer specification.

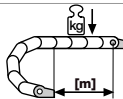

3

Determine length of travel

Compare the fill weight calculated in (point 2) to the maximum fill weight of the selected E-Chain® and check suitability for "unsupported application".

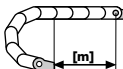

4

Unsupported length

The maximum unsupported length initially depends on the fill weight and the E-Chain® selected. At the same time, there are three different levels of unsupported length: 1 **FL_G - Recommended Range of Application** 2 **FL_B - Permitted Sag** 3 **Critical Sag: Should never be operative installation!** Twice the value of the unsupported length determines the maximum travel in the "unsupported" type of operation. For evaluation the weight of the cables to be carried must be known, then an exact evaluation can be made using a diagram on the introductory page of the selected product. You will find the values for **FL_G** and **FL_B** in table form on the following pages of this chapter and for each Series in the catalog. They are necessary for: ● Finding the fill weight and length of travel for the appropriate E-Chain® ● Identifying the maximum load of the E-Chain® used.

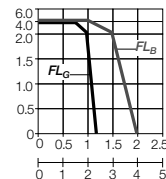
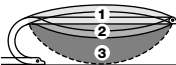

If there is suitability for "unsupported straight", then the selection follows the following criteria:

5

Opening Principle - The quick selection gives you an overview of the type of filling potential of the E-Chain®.



6

Determine the possible **Bending Radius R** [mm] of the E-Chain® with respect to the cable diameter.

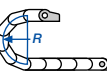

7

Interior separation is possible with...

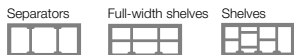

8

The **price index** gives you the possibility of making price comparisons of similar sizes within the igus® range



9

Additional criteria - for the appropriate selection of your E-Chains® such as pitch, permissible temperatures etc. are available under quick selection.

The following options are available if there is no possibility of self-supporting E-Chain® application:

A

You can choose the next and more stable E-Chain®, that can be operated "unsupported".

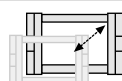

or

B

You can design your application to be "gliding".

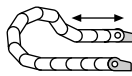

You can contact us directly or fax us your E-Chain® requests! We will respond immediately!

E-Chain® Part No: _____

Alternative E-Chain®-dimensions:

hi: _____ Bi: _____ ha: _____ Ba: _____

Fill weight: _____ kg/m

Length of travel: _____ m

Your Phone: _____

Your Fax: _____

Phone (+49) 0 22 03 - 96 49-22

Fax (+49) 0 22 03 - 96 49-222

Internet ► www.igus.eu/en/finder

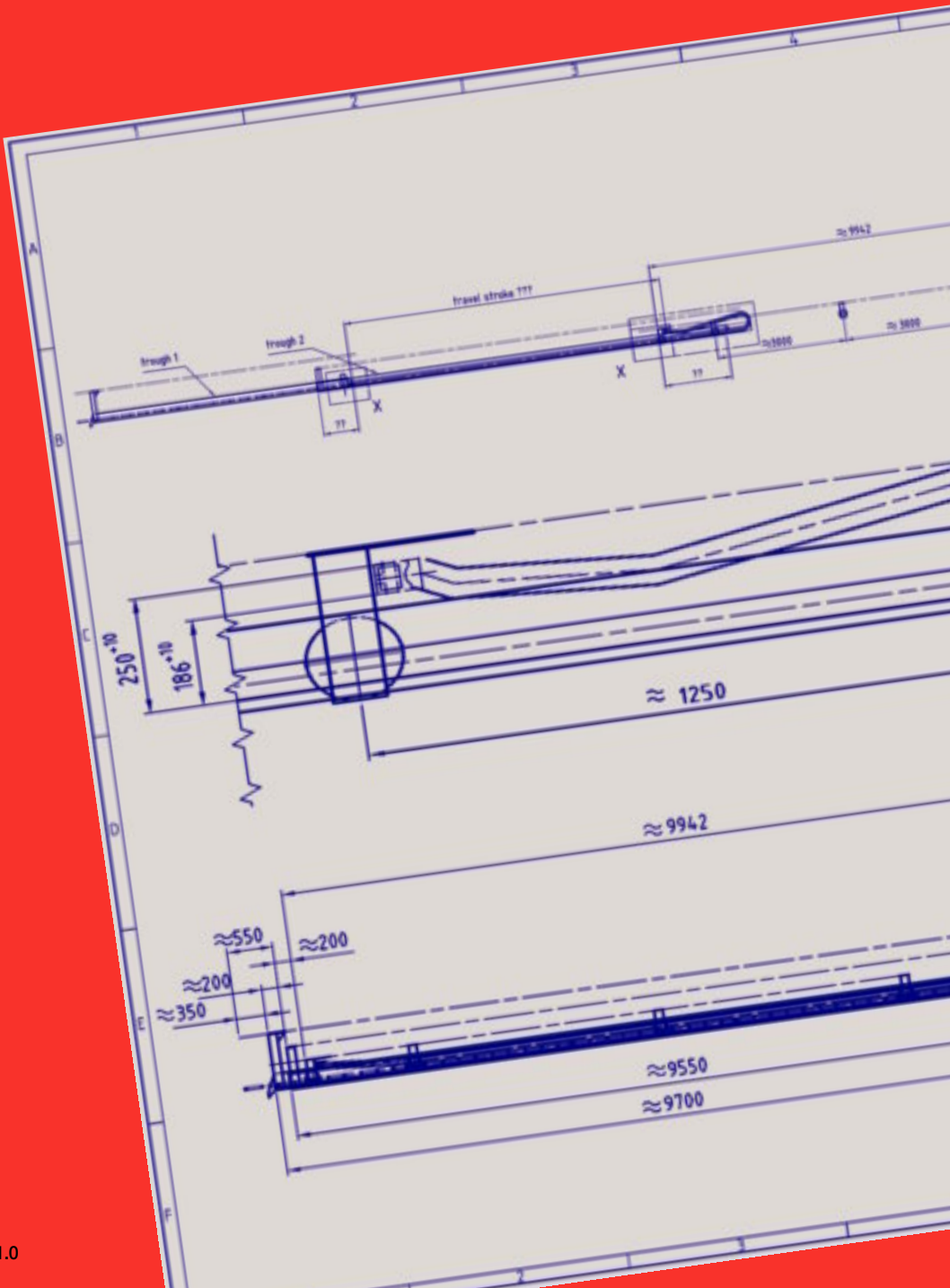

Designing with igus[®]

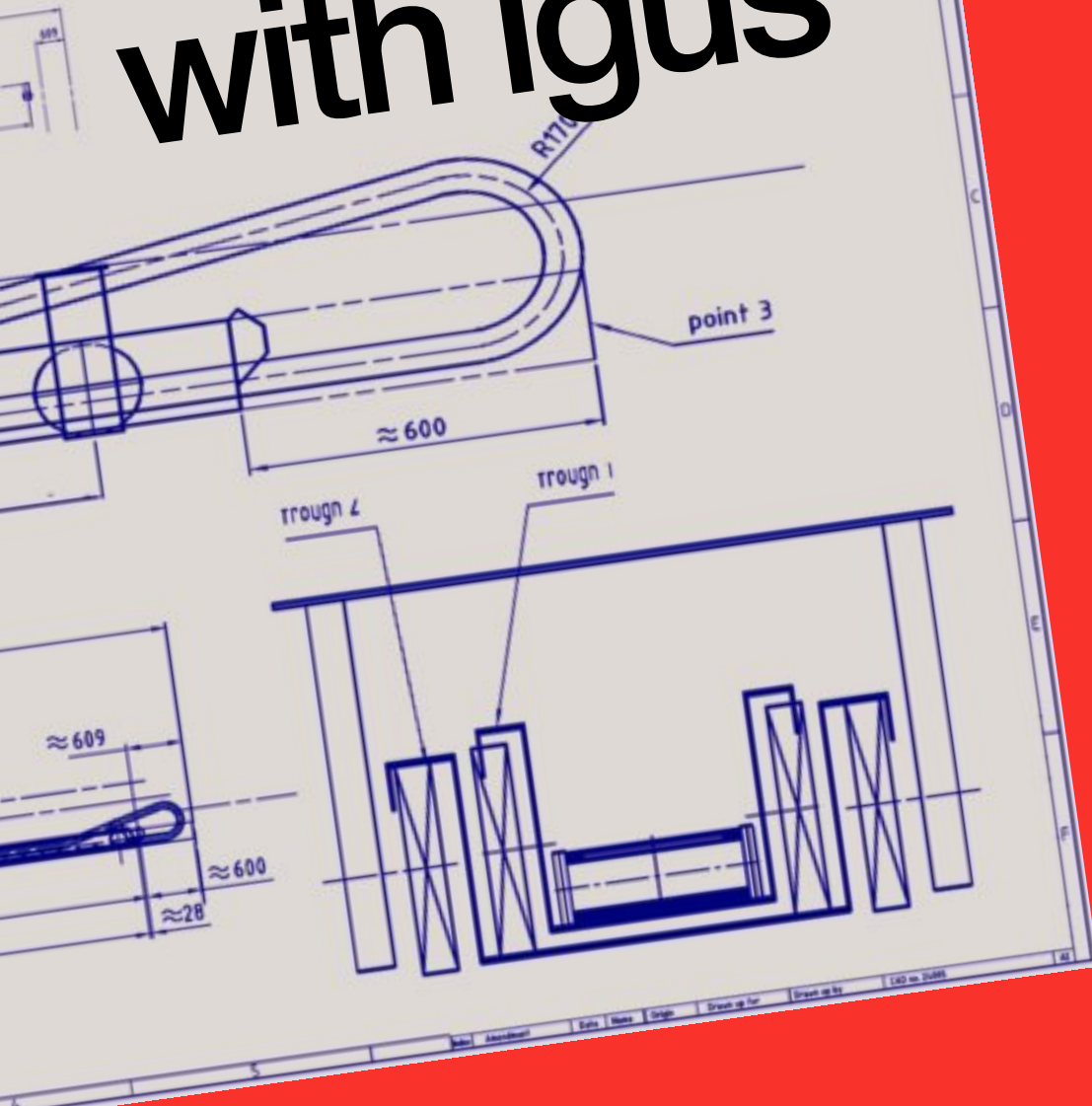

Introduction

Introduction | **Designing with igus®** page 1.3

igus® Terms | **Alphabetical Order** page 1.4

Calculation | **E-Chain®-Lengths and Camber**page 1.5

Application-Examples | **E-ChainSystems®**page 1.6

Applications

Unsupported | **Short Travels**page 1.8

Unsupported | **Noise-Optimized**page 1.11

Load Diagrams | **Unsupported Straight FL_G | Unsupported Sag FL_B** page 1.12

Gliding | **Long Travels**page 1.16

Application | **Vertical Hanging**.....page 1.20

Application | **Vertical Hanging | Zig-Zag**.....page 1.21

Application | **Vertical Standing**page 1.22

Application | **Side-Mounted**page 1.24

Application | **Rotary Motion**page 1.26

Filling and Strain Relief

Filling | **Cable and Hose Packages** page 1.28

Strain Relief Elements | **Chainfix** page 1.32

Technical Data, Standards, Material Data

Technical Environment | **Material igumid** page 1.34

Technical Environment | **ESD & ATEX** page 1.35

Technical Environment | **Clean Room and ESD** page 1.36

Technical Environment | **Dirty Environment** page 1.37

Material | **Material Data** page 1.38

Material | **Chemical Resistance and Colors** page 1.39

Certifying | **Standards and Certificates** page 1.40

ReadyChains®

ReadyChains® | **Ready-Made E-ChainSystems®** page 1.41

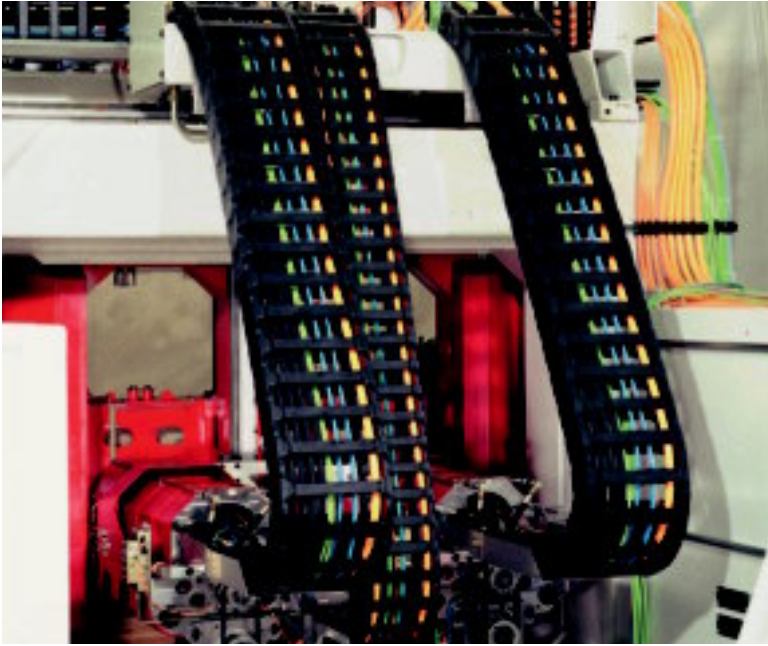

About igus® E-ChainSystems®

igus® E-ChainSystems® guide and protect moving cables and hoses on automated equipment. They can be used in a wide variety of applications and possess the following capabilities: ● **Use with various types of motion and travels** ● **Guidance of sensitive bus and data cables, as well as FOC, using the same techniques as with electric, gas, air and liquid hose guidance** ● **Long service life under very high loads and demanding requirements** ● **Smooth operation in a full range of environments and climates.** On the following pages, we offer important guidelines which are to be taken into consideration when designing safe E-ChainSystems®. All specifications are based on test results from the igus® laboratory and our field experience since 1971. Simply fill in the "igus" system design" fax sheet or log onto the igus® web site at igus.eu and e-mail us your technical specifications, or call us. **We will provide a comprehensive quote by the end of the next business day.**

Laboratory and practical experience

Our calculations and analyses are based on the result of ongoing practical tests in our Technical Center and our experience with gliding applications. The focal points of our tests are push-pull forces, friction values and abrasion under widely varying conditions and speeds, as well as factors such as dirt, weathering or impact and bumps. We test all system components such as cables, hoses, strain relief and other accessories, in addition to the E-Chains® or E-Tubes and Guide Troughs.



The igus® test laboratory for E-Chains® and Chainflex® cables

Application-Icons



Unsupported - short travels



Gliding - long travels



Vertical hanging



Vertical standing



Side-mounted



Rotary motion



Horizontal and vertical



Nested



Side by side



Combined motions

On looking through and handling of this catalog,
you will find the following terms and formula:

Short cut	Description	[°]
α	= The rotation angle of the rotating machine element	[°]
ΔM	= Deviation of the center point	[mm]
a	= Acceleration	[m/s ²]
AR	= Outer radius, E-Chain®	[mm]
Ba	= Outer E-Chain® width	[mm]
Bi	= Inner E-Chain® width	[mm]
B_{Ra}	= Guide trough outer width	[mm]
B_{Ri}	= Guide trough inner width	[mm]
D	= Over length E-Chain® radius in final position	[mm]
D_2	= Over length for long travels gliding	[mm]
FL_B	= Unsupported length with sag	[m]
FL_G	= Unsupported straight length	[m]
FL_U	= Unsupported lower run	[m]
FZ_{max}	= Maximum additional load	[kg/m]
H	= Nominal clearance height	[mm]
H_2	= Installation height with lowered mounting	[mm]
ha	= Outer E-Chain® height	[mm]
H_F	= Required clearance height	[mm]
hi	= Inner E-Chain® height	[mm]
H_{Ra}	= Outer trough height	[mm]
H_{Ri}	= Inner trough height	[mm]
IR	= Inner radius, E-Chain® (TwisterChain®)	[mm]
K	= Add-on for bending radius (K is taken from the data tables of the individual igus® Series)	[mm]
K_2	= Further add-on if the mounting bracket location is set lower (for long travels)	[mm]
L_K	= E-Chain® length	[mm]
n	= Number of links	[1]
n_{Mon}	= Number of installation sets (left/right)	[1]
n_{Ri}	= Number of trough-sets (left/right)	[1]
R	= Bending radius	[mm]
RBR	= "Reverse bending radius"	[mm]
S	= Length of travel	[mm]
$S/2$	= Half length of travel	[mm]
T	= Pitch	[mm]
v	= Speed (travel)	[m/s]
X_1	= Inner machine-construction space (TwisterChain®)	[mm]
X_2	= Outer radius chain, including clearance (TwisterChain®)	[mm]

Formula	Description
$SFL_B = 2 \cdot FL_B$	= Calculation of maximum travel length, unsupported with sag
$SFL_G = 2 \cdot FL_G$	= Calculation of maximum travel length, unsupported straight
$B_{Ri} \geq Ba + 5$	= Calculation of the minimum guide trough width
$H_{Ri} \geq 2 \cdot ha$	= Calculation of the minimum guide trough height
$K = \pi \cdot R$	= Add-on for bending radius
$L_K = S/2 + \Delta M + K$	= Calculation of chain lengths - for all types of applications, fixed end is outside the center of travel
$L_K = S/2 + K$	= Calculation of chain lengths For all types of applications, fixed end in the center of travel, except rotary movements and most long travels [m]
$L_K = S/2 + K_2$	= Calculation of chain lengths for long travels, fixed end in the center of travel [m]

Calculation of E-Chain® lengths

If the fixed end of the E-Chain® is located in the center of the travel, the E-Chain® length " L_K " is calculated by using half the length of travel and adding the value " K " for the curved length. (You can obtain the value " K " from the tables in the catalog.) Placing the **Fixed End** in the center of the travel is the most **cost-effective solution** because it requires the shortest E-Chain®, cables and hoses.



The fixed end in the center of the travel is the most favorable solution

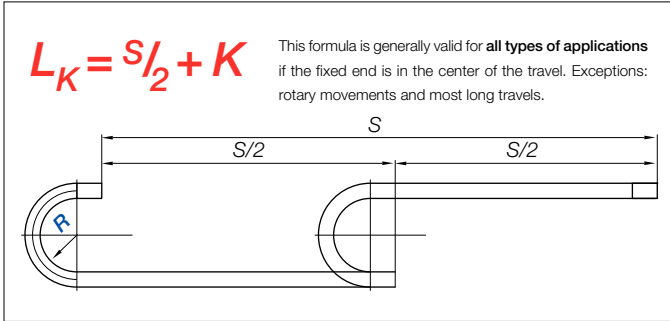

- L_K = E-Chain® length
- S = Length of travel
- R = Bending radius
- ΔM = Deviation from the center point
- $K = \pi \cdot R + \text{"safety"}$
- Add-on for bending radius (K is taken from the data tables of the individual igus® Series
- H = Nominal clearance height
- H_F = Required clearance height

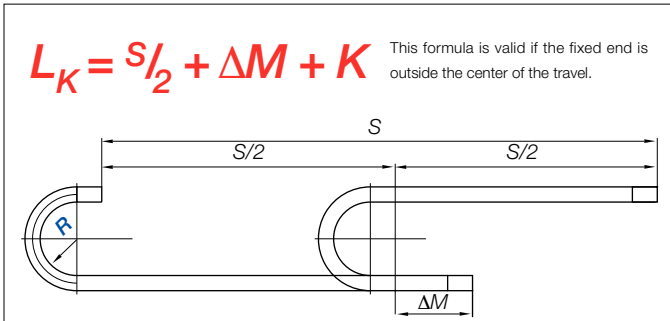

Camber

Camber is the curve of the upper run along its unsupported length. **All igus® E-Chains® are manufactured with camber, special "no camber" E-Chains® on request.** The camber allows for longer unsupported lengths and increases service life and operating safety. In the Installation Dimensions section of each respective E-Chain® description, you will find the measurement H_F , which specifies the **necessary clearance height**, taking the camber into account. Upon request, we can deliver E-Chains® without camber for restricted space applications - however, these "no camber" chains do not have the same load-bearing capacity. Please consult igus®.

"No Camber" - Special "NC" E-Chains® with no camber also available. Please consult igus®.

Necessary clearance height - depends on the camber of the E-Chain®. Find values for the necessary clearance height " H_F " on each product page.

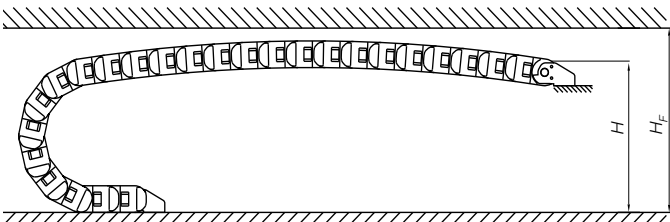

Principle of camber for igus® E-Chains® H_F = required installation height



Diagrams unsupported length ► page 1.12

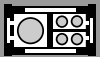
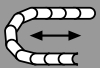

igus® E-ChainSystems®



Long travels (441 m) with Rol E-Chain®.
Long travel applications ► page 1.16



High fill weights (60 kg/m) with System E4.
Fill weights/Load diagrams ► page 1.12



Multi-axis Easy Triflex® on a production line,
combined movements ► chapter 2

Phone +49- (0) 22 03-96 49-800
Fax +49- (0) 22 03-96 49-222



ReadyChain® under water. System E4 and
Chainflex® CF9, ReadyChain® ► page 1.41



ReadyChain® with combined motions
on tooling machines ► page 1.41



Series E6.52 high speed (15 m/s) low noise
operation, optimized noise level ► page 1.11

igus® GmbH
51147 Cologne



Crash test unit: 22 m/s speed and 784 m/s²
acceleration, travel speed ► page 1.19



Complex movements with Triflex® R,
combined movements ► chapter 2



Cleanroom and Triflex® R
Technical Environment ► chapter 2

Internet: www.igus.eu
E-mail: info@igus.de



Extension links for E2 and E4 for large
conduits, cable and hoses ► page 1.28



Zig-Zag movements, 36 m height with
E4/4. Zig-Zag movements ► page 1.21



igus® System E6 - High acceleration and
ESD safety, ESD & ATEX ► page 1.35



Unsupported application System E4,
up to 50 m/s speed ► page 1.8



Unsupported, side-mounted
E4 Series R188 ► page 1.24



Unsupported application
System E4 ► chapter 7



Gliding application System E4,
up to 500 m realized ► page 1.16



Gliding, side-mounted
Series E4/4 ► page 1.24



Gliding application
System E4 ► page 1.23



Vertical, standing Series E4/light,
up to 6 m possible ► page 1.22



Rotary movement
System E4 ► page 1.26



E-Chains® side by side as individual or
"multiband" - Series Zipper ► chapter 4



Vertical, hanging Series E4 up
to 40 m possible ► page 1.20



Spiral and rotary movement
TwisterChain® ► page 1.26

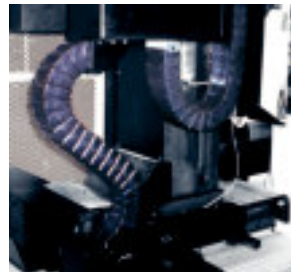

Combined movement
Series Triflex® ► chapter 2

Design
Solutions

Phone +49- (0) 22 03-96 49-800
Fax +49- (0) 22 03-96 49-222

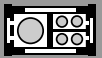
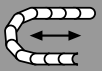



Unsupported

If the upper run of the E-Chain® operates without touching the lower run over the entire travel, it is called an "unsupported" application.

Unsupported length

The distance between moving end and the beginning of the radius curve of the E-Chain® is called the "unsupported length." It is always dependent upon the type of E-Chain® and the fill weight.



The " FL_G " type of installation always generates the longest service life and can be operated with the max. values for speed and acceleration.



Example for unsupported straight FL_G

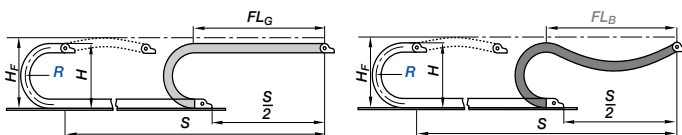

Unsupported applications

The "unsupported" application is the most common. igus® E-Chains® are very well suited for high dynamics and long service life. The maximum unsupported length is dependent upon the fill weight and the type of E-Chain® or E-Tube. As a result, we differentiate among three types of unsupported length:

01) Unsupported with straight upper run FL_G



The " FL_G " E-Chain® applies when the upper run either has camber, is straight, or has a maximum of 10-50 mm sag, depending on the size of the chain. The " FL_G " type of installation is always preferred. The E-Chain® runs quietly and is not exposed to any additional vibration.

02) Unsupported with permitted sag FL_B

The " FL_B " E-Chain® applies when the sag amounts to more than 10-50 mm, depending on the chain size, and less than a defined maximum sag. This maximum sag is dependent on the type of chain. The " FL_B " application is technically permissible in many cases. It becomes problematic if the acceleration and the travel frequency are high.

03) "Critical sag"

If the sag is greater than permissible for " FL_B ", then we refer to it as "critical sag." An installation with critical sag must be avoided or reserved for extreme circumstances. An E-Chain® should never be installed with critical sag. There are applications which, after a very long period of use, reach the stage of "critical sag." The E-Chain® or E-Tube should be replaced at that time.

Please contact us if your application reaches critical sag!

The following important factors should be considered to select the correct E-Chain®:

- Unsupported length
- Speed
- Acceleration
- Service life
- Load bearing areas
- Noise level
- Technical environment

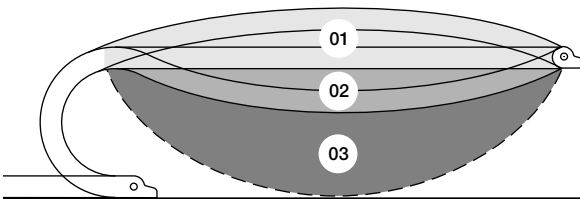



Example of unsupported permissible, FL_B

Unsupported Length

For every igus® E-Chain® or E-Tube, you will find the values for " FL_G " and " FL_B " in two locations: On the following pages in this chapter as an overview and within every individual series' chapter. These values are essential for: ● Finding a suitable E-Chain® for your fill weight and travel distance ● Identifying the maximum load for the selected E-Chain®. **Diagrams unsupported length** ▶ from page 1.12

What to do if the unsupported length is insufficient

If your application, fill weight and travel fall outside the "unsupported length" parameters of the desired E-Chain®, you have the following options:

- Select a more stable igus® E-Chain®
- Support the E-Chain® in the unsupported area (this possibility has restrictions for acceleration, speed and noise as a consequence - three fundamental examples are detailed to below - please consult igus® if you are considering this possibility - we will gladly provide you with a detailed proposal)
- Use a "multiband" chain or "nest" two E-Chains® inside one another (please consult igus® regarding these options)
- Design the travel distance as a "gliding application".

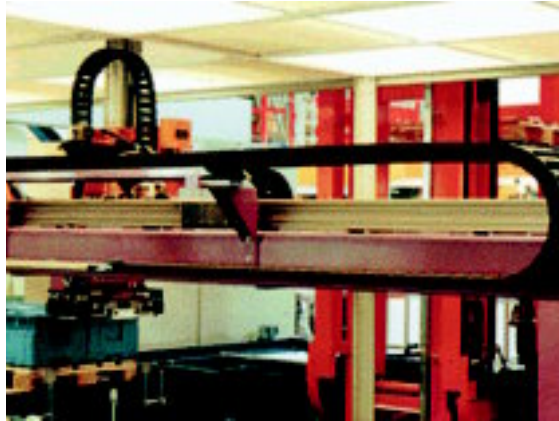

Series 28 with support of the " FL_B " area

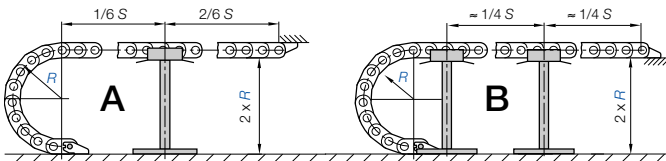

Support of the " FL_G " area. A) The overall "straight, unsupported travel" can be increased here by a maximum of 50% of the FL_G and in case of option B) by a maximum of 100%

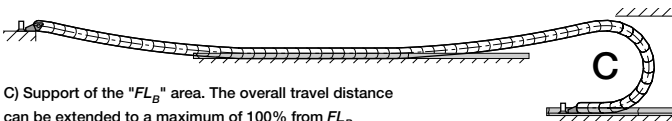

C) Support of the " FL_B " area. The overall travel distance can be extended to a maximum of 100% from FL_B

More application-examples for short travel applications ▶ www.igus.eu

Design
Unsupported

Phone +49- (0) 22 03-96 49-800
Fax +49- (0) 22 03-96 49-222





Standard values of max. speed and acceleration:

Unsupported	FL_G	FL_B
v max. [m/s]	20	3
v peak [m/s]	50	-
a max. [m/s ²]	200	6
a peak [m/s ²]	784	-

Standard value of FL_G service life: 10 million cycles



Preferred Series for max. speed and acceleration

- System E6 ▶ chapter 8
- System E3 ▶ chapter 8
- Zipper ▶ chapter 4
- Series 255 ▶ chapter 5
- E4.1 ▶ chapter 7

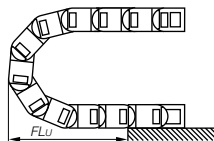

We recommend pivoting mounting brackets as standard! We recommend locking mounting brackets as standard if high speeds > 20 m/s or accelerations > 20 m/s²

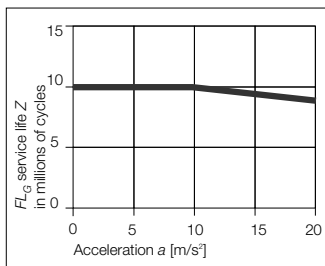

Standard values on service life for FL_G (unsupported, straight), dependent on acceleration

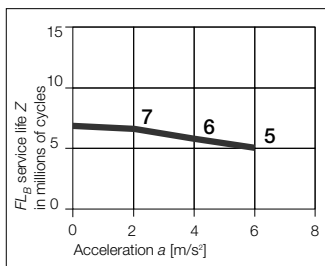

Standard values on service life for FL_B (unsupported, sag), dependent on acceleration

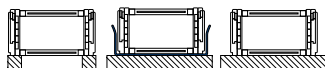

Different surfaces + guide troughs are possible

Mounting brackets

We recommend pivoting mounting brackets as standard for unsupported applications. Pivoting mounting brackets compensate for the camber, can be installed more easily and decrease the load on the first E-Chain® link in operation. **Exception:** If the acceleration is greater than 20 m/s² or if the height is limited to the H_F -measurement, locking mounting brackets keep the E-Chain® under the H_F -measurement.

Unsupported lower run

E-Chains® without support along the lower run have restricted use. The value FL_U usually must be determined in a test by igus®. The maximum permissible amount of the projection depends on the fill weight, the selected E-Chain®, the dynamics, and other factors, because the various combinations of these parameters can produce very different results. **If the lower run of the E-Chain® cannot be supported over the whole travel, please consult igus®.**



System E4 partially unsupported - please consult igus® regarding this type of configuration

Speed, acceleration and service life

For unsupported applications, the acceleration a , is the critical parameter. High acceleration can cause the E-Chain® to vibrate and reduce its service life. This is a particular danger if the E-Chain® already has a sag greater than the FL_G value. Max. values for acceleration, speed and service life are achieved only with E-Chains® incorporating the FL_G design. FL_G designed E-ChainSystems® can sustain very high loads. To date, **a peak acceleration of 784 m/s²** has been achieved during continuous use. Through ongoing testing in the igus® laboratory and from practical experience, standard values for service life have been formulated. Our tests confirm that these standard values apply to all igus® E-Chains® and E-Tubes. It is crucial to determine whether the application will be designed as unsupported straight FL_G or unsupported, with sag FL_B .

Load-bearing surfaces

Unsupported E-Chains® normally require some type of surface on which the lower portion of the E-Chain® runs. A wide range of configurations is available, as the drawings on the right demonstrate. Many material options are feasible: Metals, polymers, stone, wood, concrete, glass, etc. We also have solutions to minimize the noise generated by the chain's lower portion. Please consult igus®. When selecting the running surface, be sure dirt and debris cannot collect in the E-Chain® path.

Minimize noise levels with igus® E-ChainSystems®

The igus® program offers you optimal noise-reduction E-Chains®. The table below briefly illustrates the differences in noise level among various E-Chains®. In addition to the E-Chain®, the running surface, the dynamics and the cable and hose package play a role in overall noise generation. Have our specialists design the quietest E-ChainSystem® for your application, for example:



A reduction of 3 dB(A) sounds like a 50% reduction in the noise level to the human ear



System T3 ≤ 33 dB(A)

Optimal smoothness of motion was the prime development goal, as well as making it an economic solution. The igus® T3 profile chain is very flexible and runs -due to the special geometry- very smooth. A measurement indicates a value of ≤ 33 dB(A) at 1 m/s and with an unsupported length with Series T3.29.050.038.0, and all this with a sound pressure level generated by external noise.



System E3 - low-noise, 38 dB(A)

Long-term tests in the igus® acoustic laboratory showed reductions of 19-20 dB(A) compared with standard E-Chains®, measured at a speed of 1.8 m/s and an acceleration of 3 m/s². Figure determined in the igus® laboratory in accordance with DIN 45635, taking into consideration background noises, for the **Series E3.22.060.044.0**.



System E6 ≤ 46 dB(A)

A measurement conducted by the Rhineland Technical Inspection Authority (TÜV Rheinland) in May 2002 indicates a value of ≤ 46 dB(A) at 2 m/s and with an unsupported length of 1.5 m with **Series E6.52.10.100.0**, and all this with at least 10 dB(A) sound pressure level generated by external noise. The System E6 runs due to their small pitch very smooth. (rest weg lassen, kann ich nicht übersetzen)



System E4 ≤ 46 dB(A)

A measurement by the Rhineland Technical Inspection Authority (TÜV Rheinland) for **System E4/101, Series 221.10.200.0** indicates a value of 46 dB(A) at 1,5 m/s with an unsupported length. Due to the special rubber pads (in red pictured) of the System E4/101, the noise will be extremely damped. The standard version of E4/00 is already very noise reduced due to their special designed stop dog.

Selected noise tests - external noise corrected measurement values

E-Chain® Series	System	Averaging of the corrected sound pressure levels	Test method
igus® Series T3.29	T3	≈ 33 dB(A)	unsupported 1,0 m/s
igus® Series E3.22	E3	≈ 38 dB(A)	unsupported 1,8 m/s
igus® Series E6.52	E6	≈ 46 dB(A)	unsupported 2,0 m/s
igus® Series 221	E4/101	≈ 46 dB(A)	unsupported 1,5 m/s
igus® Series 255	E2 medium	≈ 53 dB(A)	unsupported 1,5 m/s
igus® Series E-Band	E-Band	≈ 59 dB(A)	unsupported 1,5 m/s
igus® Series 280	E4/00	≈ 64 dB(A)	unsupported 2,0 m/s
igus® Series 381	E4/101	≈ 66 dB(A)	gliding 3,0 m/s
Chain 1 Third Party Product		≈ 77 dB(A)	unsupported 2,0 m/s
Chain 2 Third Party Product		≈ 68 dB(A)	unsupported 2,0 m/s
Chain 3 Third Party Product		≈ 73 dB(A)	unsupported 2,0 m/s

Source: TÜV Rheinland, except Series E3.22 - Source: igus® laboratory



We have received an official comment from the Rhineland Technical Inspection Authority (TÜV Rheinland Berlin-Brandenburg) and we are able to provide you with a copy on request



Preferred igus® E-Chains® for minimizing noise

- System E3 ▶ chapter 8
- System T3 ▶ chapter 8
- System E6 ▶ chapter 8
- E4/101 ▶ chapter 7
- E4.1 ▶ chapter 7
- E4/00 ▶ chapter 7
- Series 255 ▶ chapter 5
- Easy Chain® ▶ chapter 3
- Series R58 ▶ chapter 6
- Series R68 ▶ chapter 6

Design Unsupported

Phone +49- (0) 22 03-96 49-800
Fax +49- (0) 22 03-96 49-222

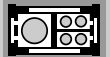

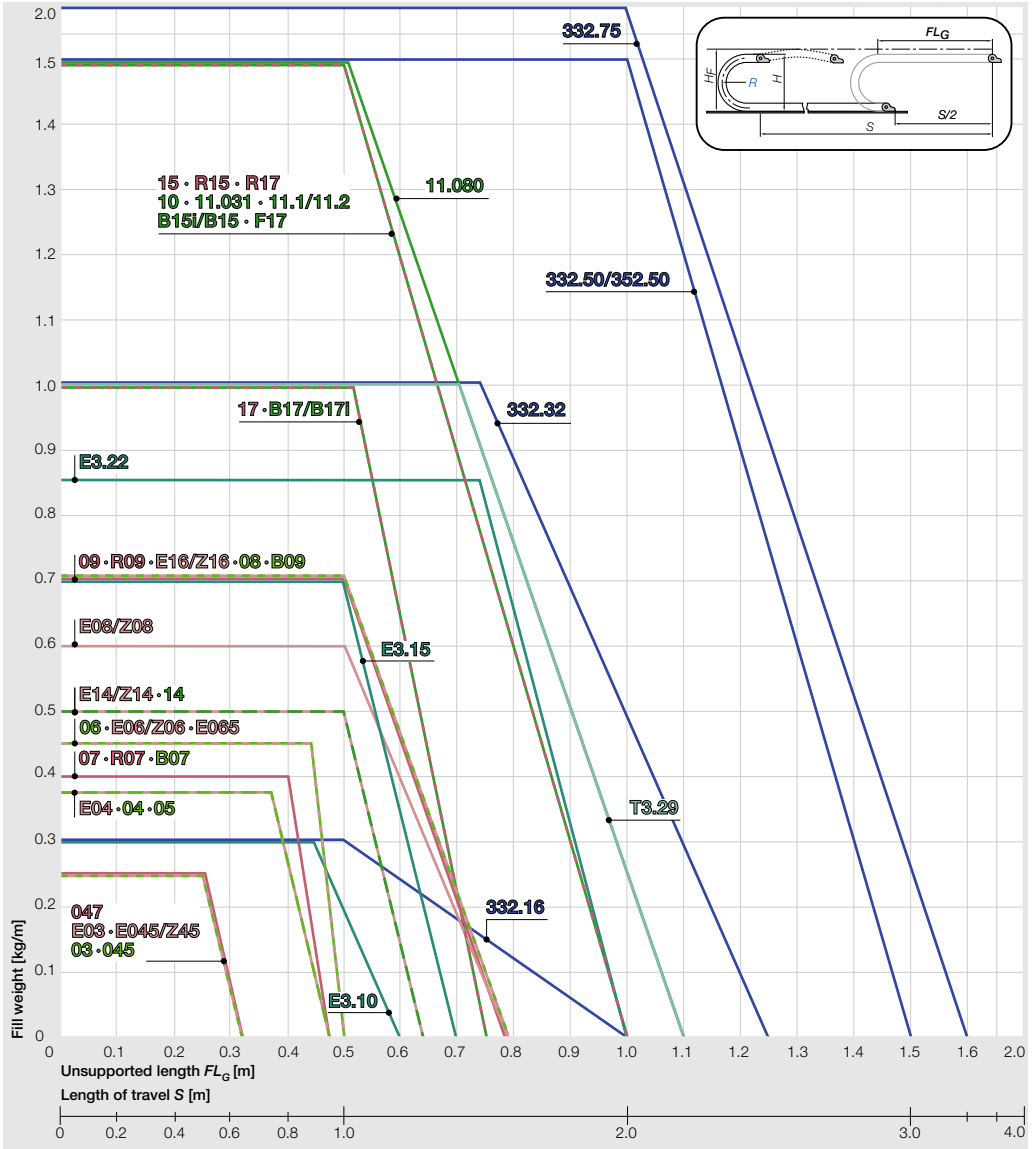

Important information

- Fill weight - Weight of all cables and hoses, including contents (for media hoses) within the E-Chain®, typically given [kg/m]
- FL_G - unsupported E-Chain® with straight upper run
- FL_B - unsupported E-Chain® with permitted sag
- To the right of the FL_B graph of the diagram, the application is shown in "critical sag", which must be avoided!

These values are essential for: ● Finding a suitable E-Chain® for your fill weight and travel distance ● Identifying the max. load for the selected E-Chain®. If you cannot meet your application demands using these parameters, keep in mind these specifications are conservative maximum values. In individual cases, they can be exceeded by up to 30%. Special solutions are also possible. Please consult igus®

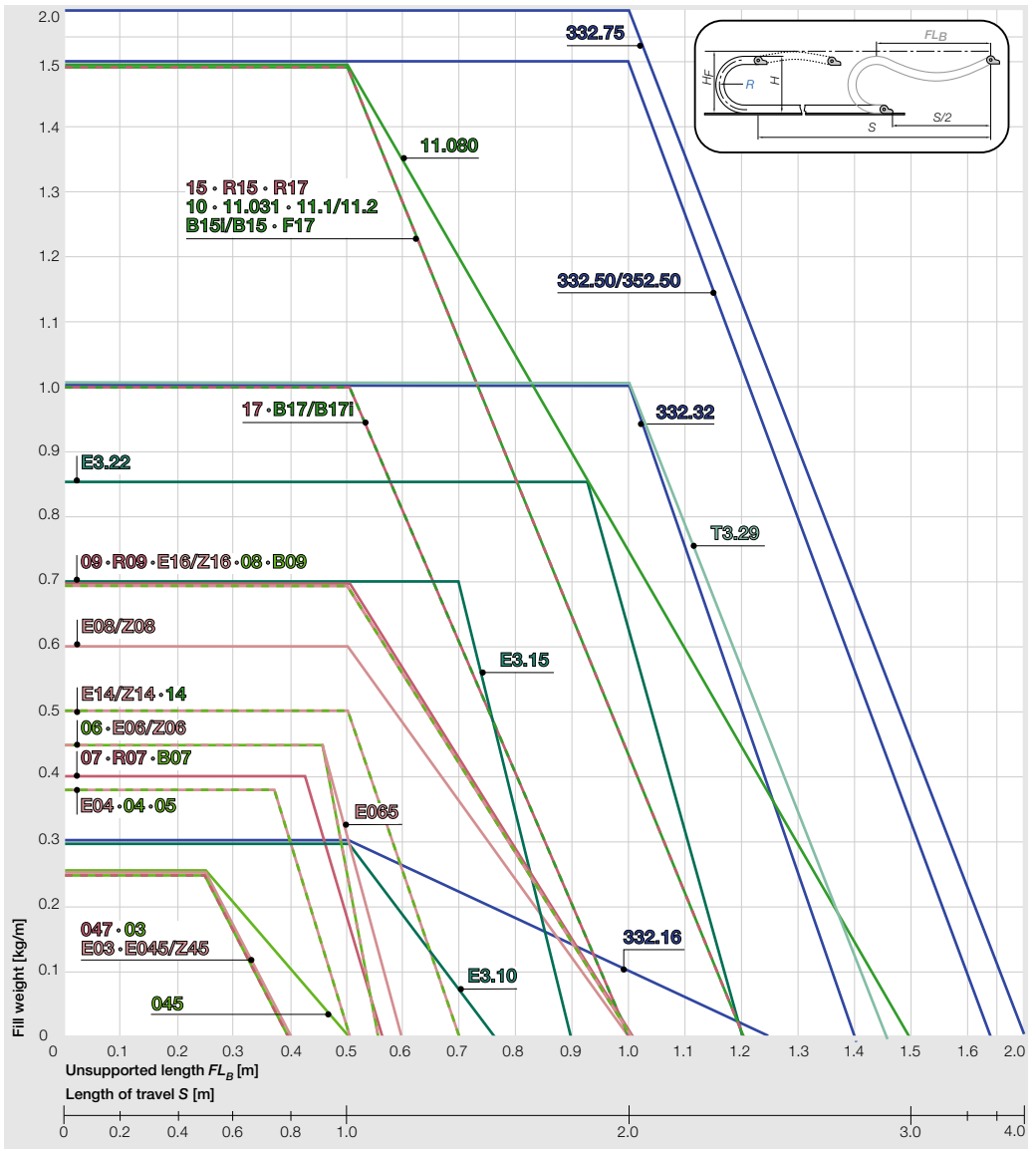

The maximum travel - always amounts to $2 \times 2 \times FL_G$ or FL_B if the fixed end is in the center of the travel. In this case, the following applies:
E-Chain® length: $L_k = S/2 + K$
 S = Length of travel
 R = Bending radius
 H = Nominal clearance height
 H_F = Required clearance height
 $K = \pi \cdot R + \text{"safety"}$ Add-on for bending radius
 (K is taken from the data tables of the individual igus® series)

Diagramm Series You will find both diagrams for each series listed individually in the catalog!

■ Triflex®	▶ chapter 2
■ Easy Chain®	▶ chapter 3
■ System E3	▶ chapter 8
■ System T3	▶ chapter 8
■ Zipper	▶ chapter 4
■ E2 micro	▶ chapter 5
■ E2 mini	▶ chapter 5

Find the values for " FL_G " and " FL_B " also ▶ in every individual Series chapter!

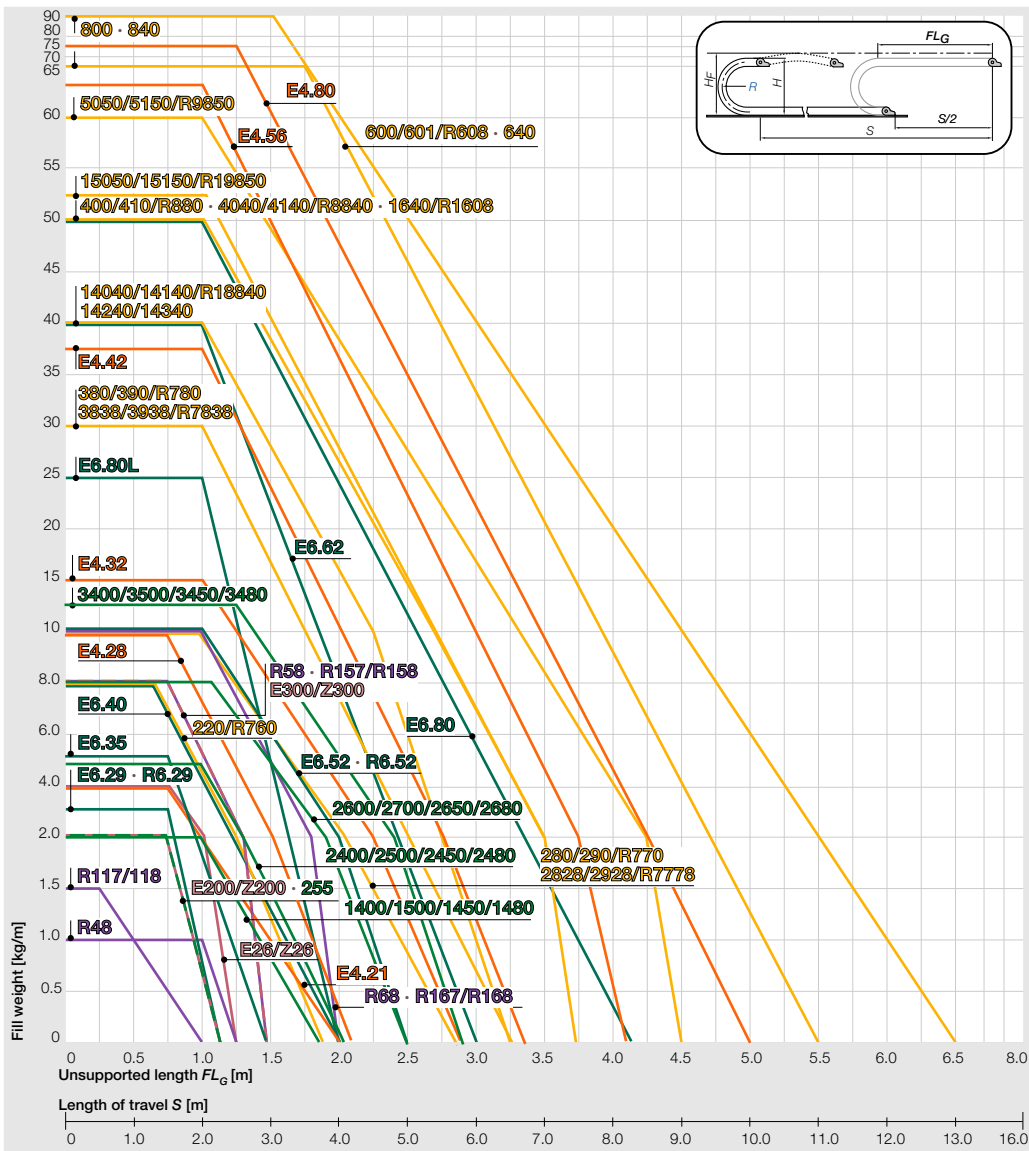

Important information

- Fill weight - Weight of all cables and hoses, including contents (for media hoses) within the E-Chain®, typically given [kg/m]
- FL_G - unsupported E-Chain® with straight upper run
- FL_B - unsupported E-Chain® with permitted sag
- To the right of the FL_B graph of the diagram, the application is shown in "critical sag", which must be avoided!

These values are essential for: ● Finding a suitable E-Chain® for your fill weight and travel distance ● Identifying the max. load for the selected E-Chain®. If you cannot meet your application demands using these parameters, keep in mind these specifications are conservative maximum values. In individual cases, they can be exceeded by up to 30%. Special solutions are also possible. Please consult igus®

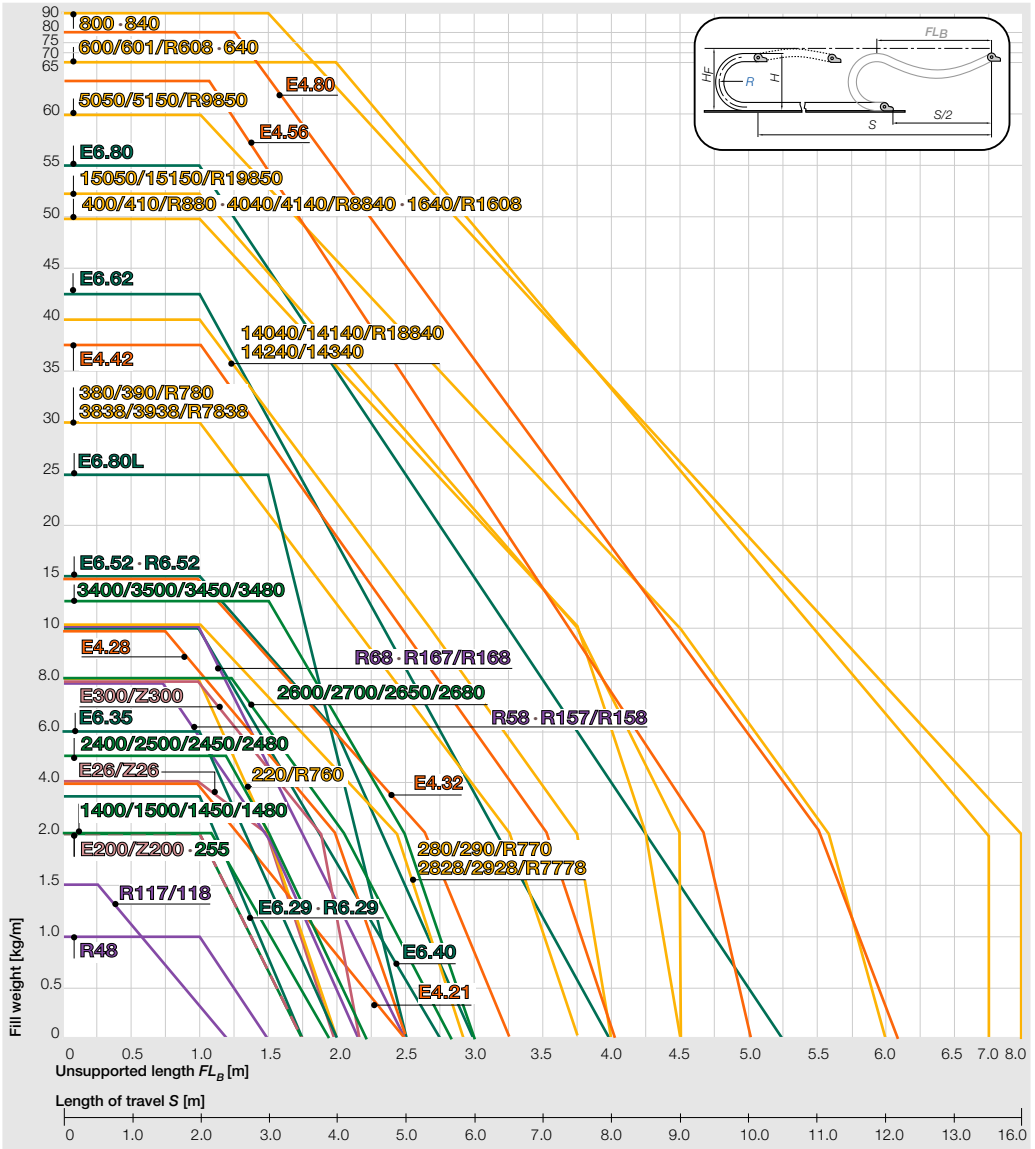

The maximum travel - always amounts to $2 \times 2 \times FL_G$ or FL_B if the fixed end is in the center of the travel. In this case, the following applies:

E-Chain® length: $L_k = S/2 + K$

S = Length of travel

R = Bending radius

H = Nominal clearance height

H_f = Required clearance height

$K = \pi \cdot R + \text{"safety"}$ Add-on for bending radius

(K is taken from the data tables of the individual igus® series)

Diagramm Series You will find both diagrams for each series listed individually in the catalog!

- Easy Chain® ▶ chapter 3
- E2/000 ▶ chapter 5
- E2 E-Tubes ▶ chapter 6
- E4.1 ▶ chapter 7
- E4/00 ▶ chapter 7
- E4/4 ▶ chapter 7
- E4/light ▶ chapter 7
- E6 ▶ chapter 8

Find the values for " FL_G " and " FL_B " also ▶ in every individual Series chapter!



Gliding application -

If the upper run of the E-Chain® rests on the lower run, it is a gliding application



- Over 400 m travel
- 6 m/s speed
(up to 10 m/s possible after consultation with igus®)
- Fill weights up to 70 kg/m



Conveyor belt in quarry. Application with travel distance of 179 m, travel speed 67 m/min., fill weight 8 kg/m

Advantages for long travel applications with igus® E-Chains®

- Travels over 400 m
 - Gliding speeds up to 5 m/s (more in individual cases)
 - Service life of 10 years and more with igus® E-ChainSystems®
- Further advantages of the design are:**
- Many different types of cables and hoses can operate side by side in the same system (i.e. electrical, data, fiber optic cables with hydraulic and pneumatic hoses)
 - Space-saving installation
 - Quiet operation
 - High accelerations
 - Durable in wind, weather, dirt, and chemicals
 - Simple assembly of the modular system on the spot
 - Rapid assembly and replacement of cables and hoses

Design assistance, free of charge

We recommend that igus® calculate every gliding application for you. We will always offer the most cost-effective solution, taking the technical requirements and operating safety into consideration. The system solution designed by us is also automatically given an igus® system guarantee. **To be able to advise you accurately, we require the following specifications:**

- Travel [m]
- Travel speed [m/min] or [m/s]
- Acceleration [m/s²]
- Fill weight [kg/m]
- Maximum cable/hose outer diameter [mm]
- Type and number of cables and hoses
- Required bending radius [mm]
- Cycle frequency (n/day or n/hour)
- Technical environment.

Please call us and within hours you will receive a detailed system proposal!



Long travel "off the reel." Up to 100 m travel pre-assembled and ready to install

Trends in long travel applications

Very long travels with igus® Rol E-Chain. - Rolling instead of gliding: 75% less push-/pull forces due to special roller-links. Travels up to 800 m are possible. Longest igus® travel of 615 m with Rol E-Chain® and Chainflex®-cables ▶ igus.de/en/rolechain

Long travel systems "off the reel" - save already at the state of assembling: Complete custom-made E-ChainSystems® with cables, connectors, strain relief - are delivered on the reel and "rolled off" into the preassembled Guide Troughs. Time savings of 50 % possible. Please ask us for references ▶ igus.de/en/readychain

Long travels without guide troughs: Our AUTO-GLIDE system consists of self-guiding E-Chains® for travels up to 50 m travel lengths (speed 1,5m/s) due to special gliding elements on the crossbars ▶ igus.de/en/autoglide

Long travels with very small E-Chains®. Micro Flizz® offers the guidance of cables inside a small E-Chain® with high acceleration on long travel applications ▶ igus.de/en/flizz-n



Longest igus® travel of 615 m with Rol E-Chain® and Chainflex®-cables



Preferred igus® E-Chains® gliding, long travels

- System P4 ▶ chapter 9
- Rol E-Chain® ▶ chapter 9
- System E4 ▶ chapter 7
- E2/000 ▶ chapter 5

Gliding applications principle

For long travels, the upper run of the igus® E-Chains® rests on the lower run and partially at the same height on a glide bar. The diagrams below show this. For lateral guidance, a Guide Trough is necessary. If the stationary mounting bracket and the fixed end of the cables and hoses can be placed **in the center**, the chain length is calculated as follows: $L_k = S/2 + K$. Depending on the technical data and the selected E-Chain®, the mounting point of the moving end of the E-Chain® must be lowered on some units ► **Lowered mounting height**. In our system analysis for long travels, we give exact details for your specific application.



Example of lowered mounting height



Advantages lowered

moving end:

- Space saving
- Longer travels possible
- Higher service life due to less wear

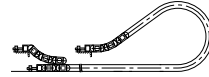

Example: Series 3838

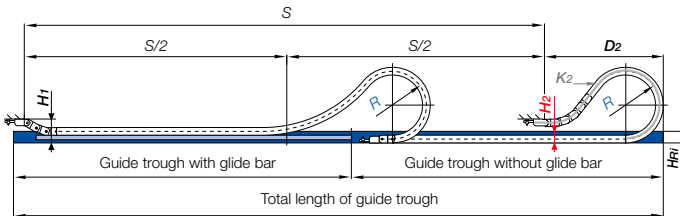

The function of an E-ChainSystem® for gliding applications (schematically)

The fixed end of the E-Chain® is located in the center of the travel distance

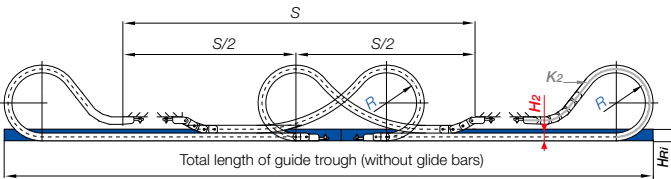

For a configuration involving two opposed E-Chains®, the travel is measured as shown and selected when these factors apply: ● Restricted space ● High loads

E-Chain® length:

- $L_k = S/2 + K_2$
- S = Length of travel
- R = Bending radius
- H_{RI} = Trough inner height
- H_F = Required clearance height
- K₂ = Further add-on if the mounting bracket location is set lower (specified by igus®)

$K = \pi \cdot R + \text{"safety"}$
Add-on for bending radius (K is taken from the data tables of the individual igus® Series)

- D₂ = Over length for long travels gliding
- H₂ = Installation height with lowered mounting

- Guide trough
- Glide bar



Recommended ratio of E-Chain® inner width *Bi* and bending radii *R* (on long travels)

The min. inner widths of an E-Chain® on long travels depend on the bending radii of the E-Chain®.

igus® specifies: $Bi_{min.} = R/4$

Please contact igus® if you have large bending radii on long travel lengths.



Gliding applications = Pivoting mounting brackets



Mobile camera, Olympic Games in Atlanta, S = 100 m, v = 10 m/s in push-pull operation



Robotics: quiet running, high acceleration, up to 10.000 cycles per day, System E4/4

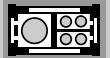
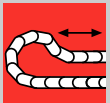



Guide troughs are used for long travels. They allow igus® E-Chain® and E-Tubes to continue smooth, low-friction operation in these long-travel situations. Various guide trough systems are available ► Guide Troughs, chapter 9



If the fixed point is in the center of the travel, use half of the guide trough with glide bars ... and the other half of the guide trough without glide bars

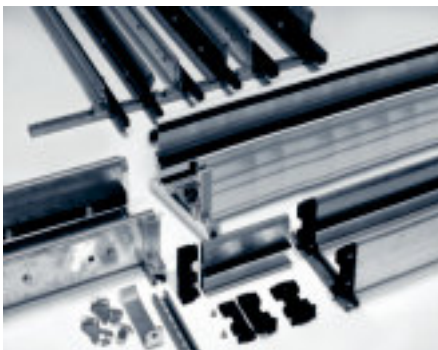

Guide troughs

The guide trough is an important element in long travel applications. Usually, the height of the trough must be at least twice that of the E-Chain® link height. The sides must provide a chamfered opening. The trough inner width is the same as the E-Chain® outer width, plus 5 mm ($B_{Ri} = Ba + 4$). Along the side of the trough, where the upper run cannot glide on the lower run, glide bars must be installed. We recommend the

use of polymer glide bars from igus®. They are optimally matched to the E-Chain® material and achieve the lowest values for friction, noise and wear. Guide troughs with and without glide bars can be obtained for almost all igus® E-Chains®. **Important: When assembling the trough parts, the following points must be given particular attention:** ● Properly align all trough parts upon installation ● All screw heads should be flush with the trough ● Smooth levelled transition between the end of the E-Chain® and the glide bars ● Solid connection with the glide surface. **These points must be observed when using assembly-friendly igus® guide troughs.**

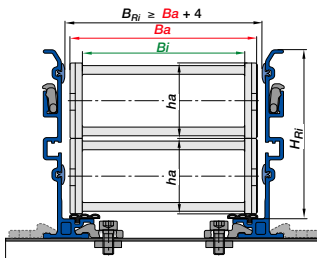

Demonstration: Guide troughs without glide bars - upper run glides on the lower run.

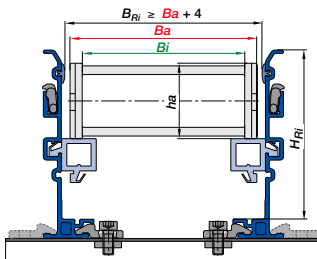

Demonstration: Guide troughs with glide bars. We recommend the use of polymer glide bars from igus® made of igulen. They are optimally matched to the E-Chain® material and achieve the lowest values for friction, noise and wear.

- Ba = E-Chain® outer width
- Bi = E-Chain® inner width
- ha = E-Chain® outer height
- H_{Ri} = Inner trough height
- B_{Ri} = Inner trough width ► depending on Ba

$H_{Ri} \approx 2 \cdot ha$
 $B_{Ri} \approx Ba + 4$

- = Guide trough-set
- = Glide bar
- = Installation set "Basic"
- = C-Profile

Glide friction values for igus® E-Chains® made of igamid G and various glide bars

igamid G	igus® polymer	Glide sheet steel	Anodized aluminum	Stainless steel
special	bar igulen			
Friction value	0,19	0,45	0,54	0,48
dynamic				

Travel speeds and accelerations

Travel speeds up to 5 m/s in continuous operation are possible and in use on current applications. In special cases, even higher speeds are possible. For example, E4/00 and E4/4 E-Chains® achieve **speeds of 22 m/s and accelerations of 784 m/s²** in crash test units. (Only a few thousand cycles per year are required in this situation.) Acceleration plays a large role in the calculation. Differentiations must be made between normal operational acceleration and a sudden jolt of acceleration such as unexpected stops or so-called "E-stops." Even in these situations, igus® E-Chains® prove to be very durable.

Service life

We offer service life calculations for your application based on our extensive gliding application experience. As developers of polymer plain bearings, we possess vast material behavior knowledge which we apply to the development of E-Chains® as well. Units with 200 m travels have been in operation for 8 years with



Automated storage/retrieval system with System E2 and Chainflex® cables - travels up to 80 m and speed of 4.5 m/s

minimum maintenance. Units up to 60 m travels have been in operation for 12 years with almost no maintenance. (Please consult igus® for references and calculations for your project.) The maintenance-free aspects of igus® E-ChainSystems® over long periods and under rough operating conditions is often the deciding factor in choosing igus®. Our system guarantee (depends on the application) provides additional peace of mind.

Technical environment

Long travel applications using igus® E-Chains® run in water, in dirt, in the tropics, in explosion risk areas (with special design features) and many other conditions. Guide troughs can be supplied in corrosion-free materials. You will find more details in the Technical Environment section of this chapter.

Calculation

Comprehensive tests place us in the position of knowing our products precisely. Important factors in these tests are: ● Push-pull forces under both ambient and extreme temperatures ● Humidity and dirt ● Friction values of the polymers, alone and against various glide surfaces ● Behavior of electrical conduits under push-pull conditions ● Behavior of hydraulic and media hoses under push-pull conditions ● Service life, and noise generation. **If we cannot in fact calculate your application based on these factors, we will perform a practical test for you in our laboratory. Please consult igus®.**



E4 in a pre-cast concrete plant with dust and concrete sediment

Technical data - long travels

Travel max	600 - 800 m
Travel speed max	10 m/s
Travel acceleration max	dependent on calculation, can be 50 m/s ² and more
Fill weight maximum	dependent on calculation, can be 70 kg/m and more



Corrosion-free guide troughs are available in the material:

- Normally galvanized
- Stainless steel
- Seawater resistant aluminum

Special properties - Long travel applications

E-Chains® that are **nested** can be used in gliding applications. This type of installation is most often used when there is a width restriction. Guide troughs with special wall heights are necessary, E-Chains® **running side by side**, or in a "multiband" design can also be used in gliding applications. Higher fill weights often require special guide troughs which can be delivered either from stock or on short notice. We have also developed standard parts for unconventional solutions involving **large hoses** in gliding applications.



Nested, gliding E-Chains®



"Multiband" E-Chain®

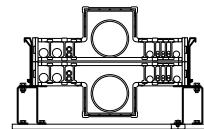

Large hose elements

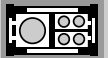
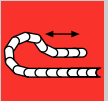

igus® E-ChainSystems®

Phone +49- (0) 22 03-96 49-800
Fax +49- (0) 22 03-96 49-222

igus® GmbH
51147 Cologne

Internet: www.igus.eu
E-mail: info@igus.de



We recommend locking mounting brackets for hanging applications. In restricted spaces, other solutions are possible with consultation

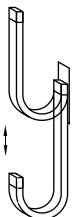

In most cases, vertical motion applications do not require lateral guidance

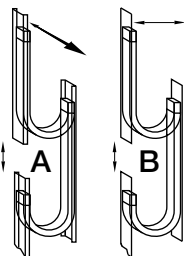

Lateral acceleration can occur in two directions - guidance is necessary

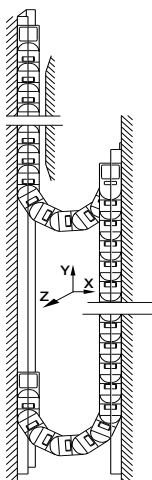

Principle of a hanging E-Chain® with lateral guidance - lateral accelerations in both directions are intercepted



Vertical, hanging applications

In accordance with the principle of "hanging" applications, heights of over 100 m are possible with igus® E-Chains®. Chains with interior separation allow many different types of conduits to operate together in the same system without becoming entangled.

Cables and hoses

Two important factors in vertical hanging applications are how the conduits lay in the E-Chain® and how they are secured at the end points: All cables and hoses must be hung so that they bear their own weight. The E-Chain® fulfills the function of orderly conduit bundling only and should not absorb any further tensile forces.

igus® interior separation elements should be used for distinct division of all cables and hoses. **The cables and hoses must be secured carefully to both end points of the E-Chain®.** The strain relief must be designed so that the opposite run cannot catch. **Safe strain relief and clear separation of the conduits are the basic prerequisites for hanging installations - Cables must be able to move freely and bear their own weight.**

Camber

A normal igus® E-Chain® with camber is suitable for hanging use if enough space is available. If there is no room - as is frequently the case for storage and retrieval systems in narrow aisles - a "no camber" E-Chain® must be ordered. **Order example: 2700.07.100.0.NC (NC = no camber).** These versions are offered at no additional charge (Exception: System E2 E-Chains® + 6%), but with a slightly longer delivery period - usually 1-2 business days longer.

Vertical motion without lateral acceleration

If the application involves vertical motion without lateral acceleration, the E-Chain® can be installed without lateral support. If the space restrictions are severe, an igus® E-Chain® with no camber must be specified.

Vertical motion with lateral acceleration

If lateral acceleration occurs, lateral guidance of the E-Chain® must be provided in most cases. The diagram to the right shows the principle of such guidance. Partial guidance is also an option - however, it must at least cover the area in which the E-Chain® may sway. Lateral acceleration can occur in two directions. The lateral guidance must be installed accordingly. If you have a choice, the layout in **Figure A** is preferred. Additional guidance along the side of the E-Chain® helps to stabilize the chain further.

Guidelok vertical - no swinging sideways of the E-Chain®

The problem: Suspended E-Chains® swing out due to transverse acceleration - **The solution:** igus® "Guidelok" system. E-Chain® stays on track even with acute transverse acceleration! When the chain moves over the control button ① the fixing button ② is moved, the lower run of the E-Chain® held in place, preventing it swinging out. For elevators, racking units, material handling equipment. igus® For vertical applications with lateral motion, igus® Guidelok offers a simple, costeffective and safe system solution. Please call us if you're interested in this product! **Typical applications** ● Automated storage/retrieval systems ● Lifts ● Revolving storage systems ● Diagonal lifts ●

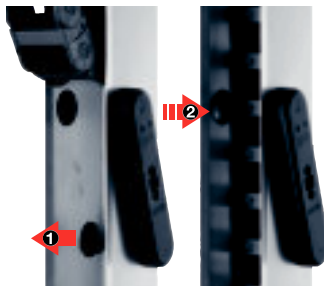

All vertical applications ► page 9.98

Video ► www.igus.eu/guidelok

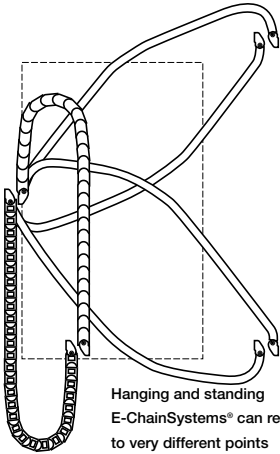

Hanging and standing E-ChainSystems® can reach to very different points



Hanging assembly with one-sided U profile

Technical data - vertical hanging

Travel height max:	100 m
v max:	20 m/s dependent on height and stability of the E-Chain®
a max:	50 m/s ² dependent on height and stability of the E-Chain®

"Zig-Zag" design

The modular design of igus® E-Chains® facilitates this space-saving and unconventional solution. For modern platform technology, such as performance stages, a variety of conduits which adjust the stage height must be accommodated. Lack of space almost invariably presents particular difficulties. The photo below shows an E-Chain® in a "Zig-Zag" configuration produced by incorporating reverse bend radii or "RBR". The unextended E-Chain® is stored in a "basket" underneath the stage. If the stage is raised, the E-Chain® unfolds, generating little to no noise. This construction is possible with System E4/4 E-Chains® as well as many other types. Please consult igus® for these kinds of applications.

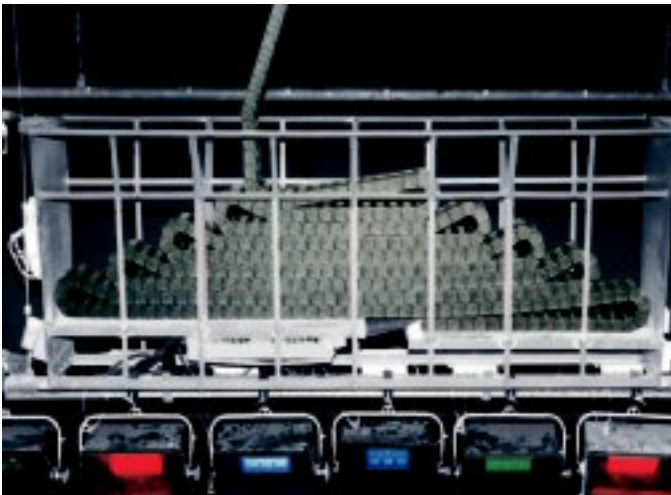

With the E-Chains® of the Systems E4 - "Zig-Zag" solutions can be realised quickly and cost-effectively without special parts



System design

Due to the wide variety of combinations involving stroke height, cable/hose packages, dynamic values, and application environments, we strongly recommend you make use of our consulting services. Simply call, E-mail or fax us.



Preferred Series for vertical, hanging design

- E4.1 ▶ chapter 7
- E4/00 ▶ chapter 7
- E4/4 ▶ chapter 7
- E2/000 ▶ chapter 5
- E2 E-Tubes ▶ chapter 6



Preferred Series for "Zig-Zag" design

- E4/4 ▶ chapter 7

Design
Vertical - Hanging

Phone +49- (0) 22 03-96 49-800
Fax +49- (0) 22 03-96 49-222

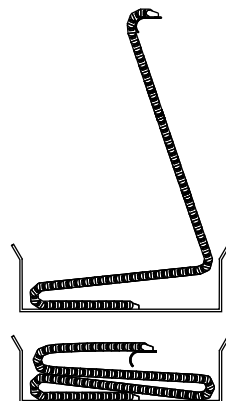
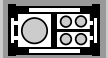
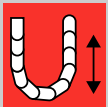

Space-saving solution - stroke heights of over 20 m are possible

igus® E-ChainSystems®



We recommend locking
mounting brackets for
standing applications

Phone +49- (0) 22 03-96 49-800
Fax +49- (0) 22 03-96 49-222



Cables must be able to move
freely and bear their own weight

igus® GmbH
51147 Cologne



Standing application with support of the first E-Chain® links - R68 E-Tube



Locking KMA mounting brackets
Series 4040 E4/4

Mounting brackets

The mounting brackets must be attached so that the E-Chain® cannot bow out. The igus® program offers locking or one-sided, locking mounting brackets for almost all types of E-Chains®. Locking KMA mounting brackets are highly recommended because they can be attached flush to the machine.

Cables and hoses

Cables and hoses must be laid in the E-Chain® so that they can bend freely. For precise guidance of the cables and hoses, we strongly recommend igus® interior spacer modules. Cables must be strain relieved at both ends.

Internet: www.igus.eu
E-mail: info@igus.de



Preferred Series for vertical,
standing applications

- E4.1 ▶ chapter 7
- E4/00 ▶ chapter 7
- E4/4 ▶ chapter 7
- E2/000 ▶ chapter 5
- E2 E-Tubes ▶ chapter 6

Technical data - vertical - standing applications

Max. stroke height - without support	= 4 m
Max. stroke height - with support of the first E-Chain® links	= 6 m
Max. stroke height - with full support	= 20 m
v max (dependent upon stroke height and weight)	20 m/s
a max (dependent upon stroke height and weight)	50 m/s²



U-shaped supported E-Tube for high lateral acceleration

Lateral acceleration

If lateral acceleration occurs, the E-Chain® should be supported along the outer radius. For higher E-Chain® heights, it is generally recommended that at least the first three links on the outer radius be supported. For maximum heights and weights, the whole distance must often be supported. **Due to the wide variety of combinations involving weights, stroke heights, E-Chain® types and bending radii, we strongly recommend you make use of our consulting services.**

Combined movements

Combined vertical and horizontal movements are possible with igus® E-Chains® for a cost-saving solution.



Combined horizontal and vertical movements

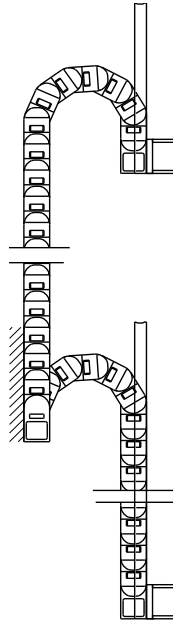

Options for a standing application with support of the first E-Chain® links: on the right, with U-shaped guidance - on the left, with the support of the first chain links



For higher E-Chain® stroke heights, it is generally recommended that at least the first three links along the outer radius be supported. For maximum heights and strokes, the whole E-Chain® must often be supported.

With lateral acceleration, the E-Chain® must be supported and, depending on the direction of this acceleration, be guided along the side

Design
Vertical - Standing

Phone +49- (0) 22 03-96 49-800
Fax +49- (0) 22 03-96 49-222

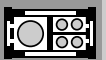
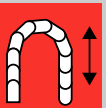



Side-mounted E- Chains® - are strongly recommended if the installation height is restricted

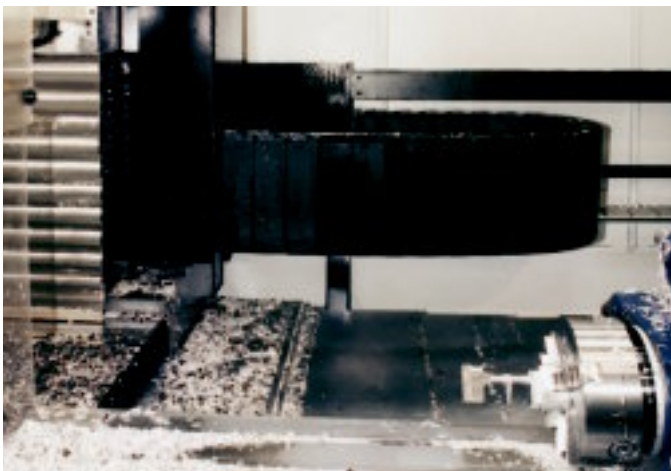

System E4/light E-Tube in direct chip area



Standard values for unsupported lengths, side-mounted, upon request. The unsupported lengths can be extended by supporting the links next to the mounting brackets

Short travels with or without support

igus® E-Chains® placed on their side can be unsupported to a limited extent. The turned "unsupported length" in this case is dependent on the following factors: ● **Fill weight** ● **Width of the E-Chain®** ● **Bending radius** ● **Parallel placement**. The greater the fill weight of the E-Chain®, the shorter the available unsupported length. When placed on its side, the E-Chain® width, in effect, becomes the height. As this "height" increases, the E-ChainSystem® becomes proportionally more stable. Small bending radii provide greater stability. If further movement in a second axis is added to the parallel motion of two chains, the unsupported length is impaired. For applications with low fill weight, the standard mounting brackets are adequate. If, however, the fill weight is high and the travels are long, the E-Chain® must then be supported either in whole or in part. Due to the variety of application possibilities, we strongly recommend you make use of our consulting services.



igus® - Series E4/4
with partial support



Unsupported - System E4



E-Chain®, side-mounted, supported System E4

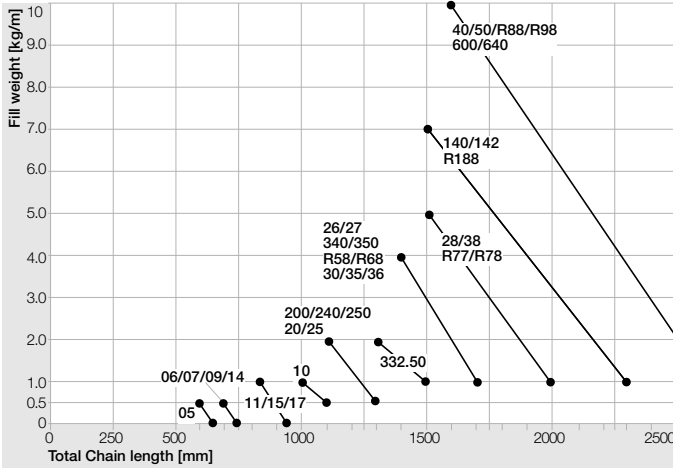

The unsupported lengths can be extended by supporting the links next to the mounting brackets
Please consult igus® for more Series and details!

Long travel, gliding

Side-mounted E-Chains® can travel over 100 m with adequate guidance. All E-Chain® types are designed to operate gliding on their side. The corresponding glide surface is usually an igus® polymer, stainless steel or galvanized steel, depending on how high the demands on the travel speed and service life are. Roller and ball bearings or additional gliding elements are not necessary for igus® E-Chains®. The diagram below shows the principle of a guide trough for side-mounted applications.

Cables and hoses

Cables and hoses must be guided so that the E-ChainSystem® can move freely at all times. The igus® modular separation options offers numerous possibilities, such as **vertical separators and spacers**, to keep these conduits separated and bending freely for maximum service life. igus® will gladly provide an application analysis, free of charge.

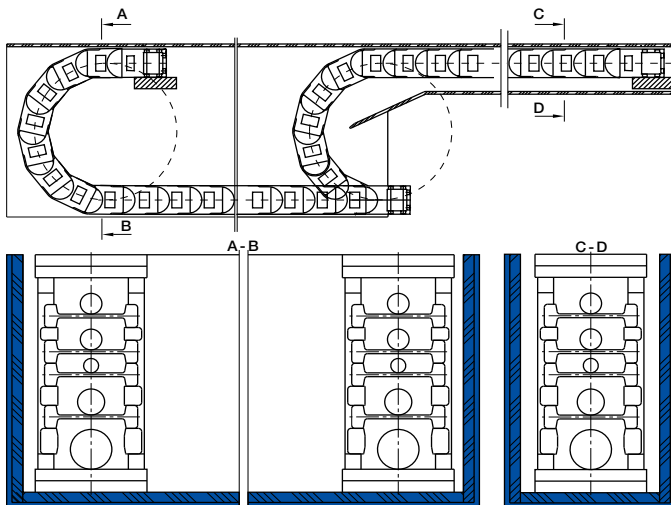

Principle of a guide trough for long travel, side-mounted



For a side-mounted gliding application, we recommend locking mounting brackets. The E-Chain® is then pushed straight through the guidance



The igus® separation elements also offer safe solutions for heavy hydraulic hoses



Cable and hose guidance with separators and spacers



Preferred Series for side-mounted applications

- E4.1 ▶ chapter 7
- E4/4 ▶ chapter 7
- E4/00 ▶ chapter 7
- E2 E-Tubes ▶ chapter 6

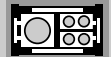
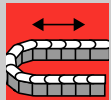

igus® E-ChainSystems®

Phone +49- (0) 22 03-96 49-800
Fax +49- (0) 22 03-96 49-222

igus® GmbH
51147 Cologne

Internet: www.igus.eu
E-mail: info@igus.de



Options 2. and 3. for rotary movements require less installation height. The E-Chains® glide mostly on surfaces made of polymer, stainless steel or steel and are guided through channels into a rotary movement. (See "side mounted" for further design tips.)

Bending radii, circular radii and E-Chain® widths are variable with this product line

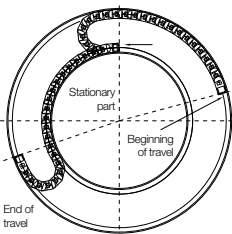

Preferred Series for rotary motion applications

- All "RBR" E-Chains®
- TwisterChain® ▶ chapter 2
- System E4 ▶ chapter 7
- E2/000 ▶ chapter 5

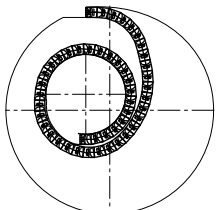
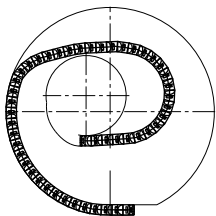

Standard E-Chain®
3500.075.200.0,
angle of rotation 225°



Rotary motion with a "standard" E-Chain®



"RBR"-rotary movement with Series 5050, installed on a crane

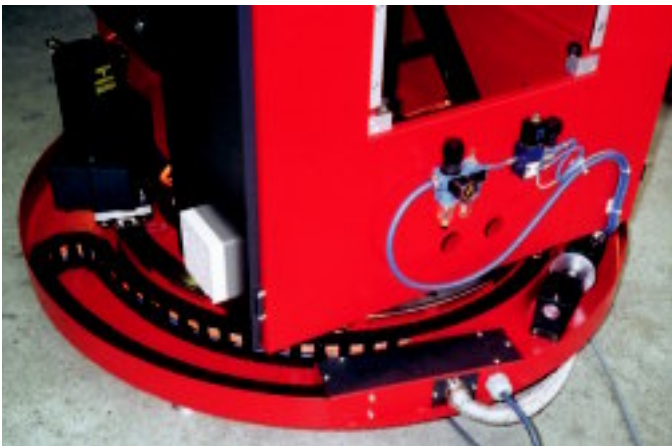

Series 250 with 360° RBR rotary motion on a robot

1. Rotary motion with TwisterChain®

The TwisterChain® product line offers the biggest selection for rotary movements. TwisterChain® solutions are particularly recommended for space-restricted applications such as articulated robots, revolving tables, etc.

2. Rotary motion with standard E-Chains®

The photo to the right shows an application which was achieved using "standard" E-Chains® (in this case, standard means that the E-Chain® only bends in one direction). Such solutions are possible if a **great deal of space** is available and if the angles of rotation are limited to a maximum of 450°. All igus® E-Chains®, E-Tubes and Chainflex® cables are appropriate for this situation.

3. Rotary motion with "RBR"

"RBR" is "reverse bending radius" and means that the E-Chain® can bend in two directions. Each igus® E-Chain® can incorporate RBR designs, with the exception of several radii, for the E-Tubes R117 to R9850 and for the Series 07, 09, 14, 15, and 17. The RBR does not necessarily need to be identical to the normal bending radius of an E-Chain®. For example: Part No. **280.15.100/425.0**, describes a Series 280 E-Chain® with an inner width of 150 mm, standard bending radius of 100 mm and RBR of 425 mm. Most rotary motions can be achieved with the RBR option. **Angles of rotation up to 540°** have been realized. Below is an example of rotary motion using an RBR E-Chain®. Please consult igus® for your particular application.

Guide troughs

Depending on the dynamics and load of the application, the guide troughs are made of steel or stainless steel. For applications with a high cycle frequency, we suggest coating the guide troughs with polymer. igus® E-Chains® require no additional gliding elements for contact with the base or sidewalls. igus® offers complete systems including guide troughs, but we are pleased to offer support with drawings for your own construction.

Product range

E-Chains® with "RBR" are available as standard from stock for the complete Triflex® range. In addition, we supply a number of E-Chains® which are equipped as standard with "RBR". For all other types, "RBR" means custom-made, and we will be more than willing to offer you this option. igus® E-Chains® with "RBR", available as standard **Easy Triflex®/Triflex®**.



Guide troughs for rotary motion applications



Many igus® E-Chains® are available with "RBR" - reverse bending radius. Please note the information text of the relevant Series in the product range

Example:

10.4.075/220



Technical data rotary motion:
 max. angle of rotation = 540°
 (larger angles possible)
 v max. = 10 m/s
 a max. = 20 m/s²

Rotary motion with RBR, diameter 6000 mm, with RBR, the inner ring rotates

Table of "RBR" E-Chains® available from stock

Part No.	Series	chapter	Part No.	Series	chapter
05.16.018/018	E2 micro	5	240.05.060/060	E2 medium	12
06.20.018/018	E2 micro	5	240.07.060/060	E2 medium	12
06.30.018/018	E2 micro	5	2400.09.055/250	E2/000	5
06.64.018/018	E2 micro	5	250.05.060/060	E2 medium	12
10.1.028/028	E2 mini	5	250.07.060/060	E2 medium	12
10.1.038/600	E2 mini	5	27.07.075/300	E2 medium	12
10.1.048/048	E2 mini	5	2700.15.150/090	E2/000	5
10.1.075/220	E2 mini	5	27i.12.125/400.0	E2 medium	12
10.2.028/028	E2 mini	5	28.00.063/063	E4/0	12
10.2.038/600	E2 mini	5	38.00.125/125	E4/0	12
10.2.048/048	E2 mini	5	40.00.135/135	E4/0	12
10.2.075/220	E2 mini	5	40.00.200/200	E4/0	12
10.3.028/028	E2 mini	5	5050.00.150/150	E4/4	7
10.3.038/600	E2 mini	5	B15i.050.100/460	E2 mini	5
10.3.048/048	E2 mini	5	EZ14.1.038/038	Easy Chain®	3
10.3.075/220	E2 mini	5	EZ14.2.038/038	Easy Chain®	3
10.4.028/028	E2 mini	5	EZ14.3.038/038	Easy Chain®	3
10.4.038/600	E2 mini	5	EZ14.3.075/075	Easy Chain®	3
10.4.048/048	E2 mini	5	EZ14.4.038/038	Easy Chain®	3
10.4.048/400	E2 mini	5	TE14.50.028/028	SnapChain	3
10.4.075/220	E2 mini	5	TE26.120.063/063	SnapChain	3

- Chainflex® cables with TPE-outer jacket are specially suitable for E-Chains® with "RBR" option
- Please use for E-Chains® with "RBR"-option a strain relief only for the moving end

The E-Chain® Series appearing on the table are "RBR" - versions available from stock. Almost all igus® E-Chains® can be delivered as a "RBR"-version. Please contact us for any special inquiry

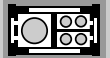



Rules for:

- Maximum conduit diameters
- Separation
- Bending radius

Electrical cables need at least 10% reserve space all around, hydraulic hoses 20%



Hydraulics and electric cables are separated from one another in this example

each conduit within the E-Chain® and the space allowed, are important for the service life of the system. Various separation options enable the adaptation of the E-Chains® to the specific requirements of each respective application. In this chapter, we give you detailed recommendations. Due to the variety of the application parameters, we strongly recommend you take advantage of our free consultation services. Simply give us a list of your cable requirements (or merely the required electrical or other services) and you will receive our recommendation by the end of the next business day.

General rules for cables and hoses in E-Chains®

The key advantage of an igus® E-ChainSystem® is the safe accommodation of various forms of data cables and energy suppliers in one system. We recommend the optimal separation layout of the conduits in the E-Chain®, but you, the customer, are still afforded the final choice. It is possible, for instance, to maintain minimum distances between bus and motor cables and mix pneumatics, electric and hydraulics in the same compartments. In addition to the quality of the cables used, the arrangement of

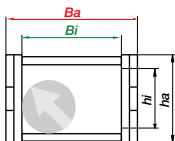

The maximum conduit diameter is specified for each Series on its respective page

Maximum cable and hose diameters

The maximum cable and/or hose diameter corresponds to the inner height of the selected E-Chain®/E-Tube, with additional minimum clearance. This minimum clearance would be, for example, 10% for electrical round cables, 20% for hydraulic hoses. An E-Chain® is ideal if a minimum lateral gap to the next cable or hose has been factored in. Depending on the nature of the cables, the dynamics, and the expected service life, more clearance must be allowed. In specific cases, clearances may be altered further. Please consult igus.



E-Chain®-Distribution

Cables and hoses with very different diameters should be laid separately. The separation is achieved using modular separators. Cables and hoses must **under no circumstances** have the opportunity to tangle. Therefore, the clearance height of a compartment with several similar cables or hoses next to one another **must not amount to more than one and a half times the cable/hose diameter.**



Neatly laid cables with igus® interior separation



Orderly laid cables with igus® interior separation

Reasons for distribution rules

The cables and hoses must be laid so that they can move freely at all times and so that no tensile force is exerted at the radius of the E-Chains®. For high-speed applications and high cycles, cables or hoses must not be laid on top of each other without horizontal separation. The standard values for this are: Travel speed over 0.5 m/s and cycles over 10,000 p.a. igus® interior separation offers a safe solution for this situation.

Further guidelines for distribution

The cable or hose weight should be symmetrically distributed along the width of the E-Chain®. Cables and hoses with different outer jacket materials must not be allowed to "stick" together. If necessary, they must be laid separately. All igus® Chainflex® cables can be combined with each and other brands of cable or hose. The cables and hoses should always be fixed at the moving end. The fixed end should always involve strain relief. Exceptions are made only for certain hydraulic hoses with length compensation issues or other high pressure hoses (i.e. hydraulic hoses). Generally, the faster and more frequently the E-Chain® operates, the more important the exact positioning of the cables and hoses inside the chain. Due to the wide variety of the possibilities, we strongly recommend you take advantage of our free consultation services for your specific applications.

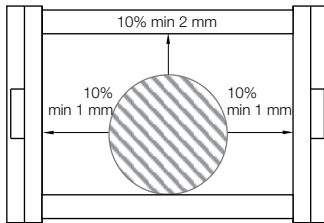
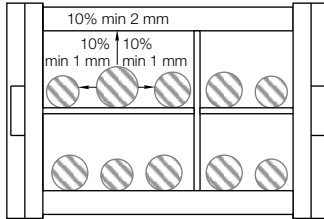
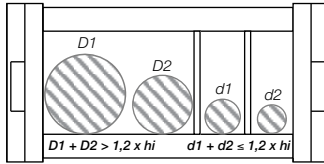

Clearance space "all around" for round electrical cables

Distribution rules:

$$D1 + D2 > 1,2 \times hi$$

Rule 1:

If $D1 + D2 > 1.2 \times E\text{-Chain}^\circ$ inner height, no separation between the two cables/hoses is necessary. Two cables/hoses should never be left unguided on top of one another or be allowed to become tangled.

$$d1 + d2 \leq 1,2 \times hi$$

Rule 2:

If $d1 + d2 \leq 1.2 \times E\text{-Chain}^\circ$ inner height, a vertical separator or a horizontal shelf must be used to reduce the inner height, thereby preventing the entanglement of $d1$ and $d2$.

All-around clearance space in % for various cables/hoses

- Electrical round cables: 10%
- Electrical flat cables: 10%
- Pneumatics: 5-10%
- Hydraulics: 20%
- Media hoses: 15-20%

Bending radius R

The bending radius of our E-Chain® depends on the "thickest" or "stiffest" cable or hose in your application. The bending radii of the E-Chains® should be adjusted to the recommendations of the cable or hose manufacturer. The selection of a larger radius than the minimum will positively affect service life. The specification of minimum bending radii for cables and hoses refers to use at normal temperatures - other bending radii may be recommended. Please ask your cable or hose supplier for details.

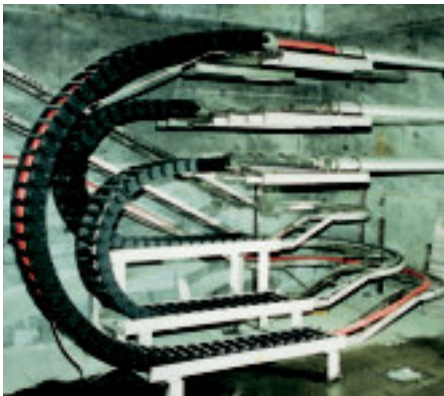

The igus® program offers up to 12 different bending radii from stock. Here, Series 50 used in the Storebaelt bridge project

We recommend complete E-ChainSystems® - where bending radii for all cables and hoses, interior separation and service life are optimally matched.

igus® Chainflex® cables permit the smallest bending radius of $5 \times d$ for one million strokes

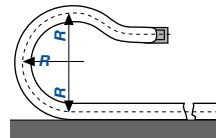

Pinciple sketch bending radius "R"



Chainflex® cables - smallest bending radius of $5 \times d$

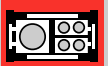
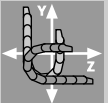



We will be pleased to provide you with recommendations for complete E-ChainSystems®: Bending radii of all cables and hoses, interior separation and service life are then optimally intermatched.



Corkscrewing: an effect of improper cable and hose placement in an E-Chain®



Example from igus® test laboratory: continuous development and testing of Chainflex® round electrical cables

Round electrical cables

For electrical cables, the round cable is a safe, modular and cost-effective solution for E-ChainSystems®. We recommend the following criteria for selecting the proper round electrical cables:

- Small minimum bending radii and mounting heights
- Strain relief integrated directly into the mounting bracket
- Uncomplicated installation process - no hanging, laying out, etc., of cables
- Long service life at minimum bending radius
- Service life expectations for your application (short or long travel, hanging, etc.)
- Test data on service life from realistic tests
- Flexible shields for shielded cables
- Abrasion-resistant and non-adhesive outer jackets
- Large selection to avoid expensive custom designs. For bus cables and fiber optic cable, special attention must be paid to how effective transmission rates and shielding remain after millions of cycles at the minimum bending radius.

Installation and strain relief of round electrical cables

- 1** The cables must be laid straight, without twisting. Cables must not be uncoiled from the top of the spool. igus® Chainflex® cables are immediately ready for placement directly into the E-Chain®. They need not be disconnected or laid out before installation.
- 2** The cables must be laid so that each individual cable can move freely from side to side.
- 3** The cables must be able to move freely along the radius. This must be double-checked if the upper run operates at the cable's maximum bending radius.
- 4** The division of the E-Chain® interior using shelves or igus® interior separators is necessary if several cables and/or hoses with varying diameters are laid out. It is important to prevent cables and hoses from tangling.
- 5** For cables and hoses with different jacket materials, it is important to prevent them from "sticking" to one another. If necessary, they should be separated. igus® Chainflex® cables can be combined with all others.
- 6** Round electrical cables must be secured with strain relief at both ends. In exceptional cases, the cables may be fixed with strain relief at the moving end of the E-Chain® only. A gap of 10-30 x cable diameter between the end of the bending segment and the fixed point is recommended for most cables. Chainflex® cables can, on the other hand, be secured directly to the mounting bracket with strain relief (this has been confirmed with testing).

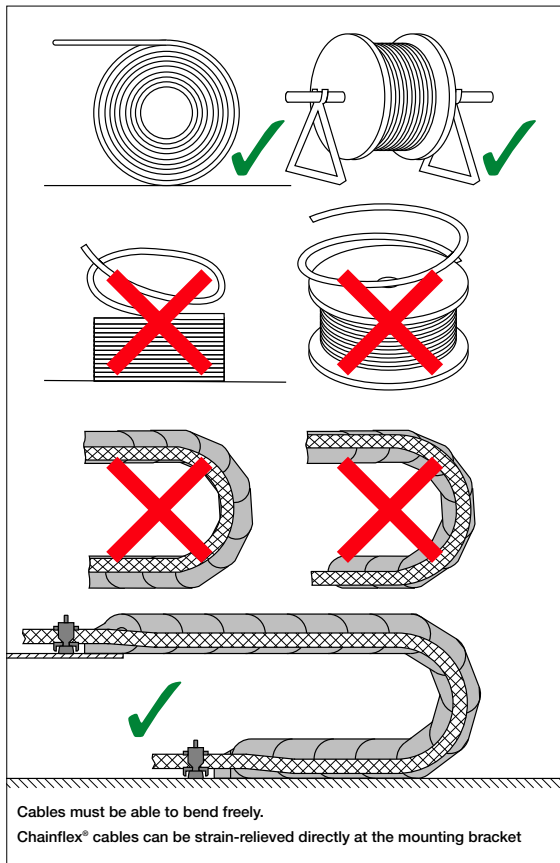

Pneumatic hoses

In principle, the same rules apply for pneumatic hoses as for round cables. In practice, it has been demonstrated that pneumatic hoses are less susceptible to wear. After consultation, they can be laid together more closely than the "10% clearance all-around" rule. A double-sided strain relief is required under these conditions. For pneumatic hoses made of rubber, we recommend strictly following the "10% clearance" rule because they tend to adhere to each other and to other conduits.



Fully pre-assembled E-ChainSystem® with several pneumatic hoses



The igus® program also offers polymer pneumatic hoses called: "Chainflex® Air"



Flat cables and pneumatic hoses installed in an E-Chain® with full interior separation

Flat cables

Flat cables must be able to move freely along the bending radius. Two flat cables next to one another should be kept apart with separators. If two flat cables are laid on top of one another, we strongly recommend the use of horizontal igus® shelving. Flat and round cables should be laid separately in the E-Chain®. Strain relief should be attached at both ends. Flat cables are only conditionally recommended for use in E-Chains®.

Flat cables - Outer jackets made of rubber must be specified particularly carefully, because of potentially high static friction.

Hydraulic hoses

When designing hydraulic hoses in E-Chains®, special attention should be paid to the expansion of the hoses when pressurized. Sufficient room must be left in the E-Chain® for this as well as the possible larger external diameter of the hoses under pressure. It is important for selected hoses to be sufficiently flexible (i.e. meet bending radius specified by the E-Chain®). The gliding ability and abrasion-resistant surface of the hoses are also important. All crossbars and shelves in the igus® E-Chain® minimize abrasion of hoses through wide, rounded and smooth surfaces. Normally, hoses with textile braiding are more flexible than hoses made of steel wire, while maintaining smaller outer diameters and better fatigue strength under reverse-travel stresses. As lateral movements of the hydraulic hoses within the E-Chain® can lead to increased abrasion of the hose material, they should be secured in position with vertical separators, but not forced. Special "locking" separators, which grip the opening crossbars of the chain, as well as the use of "spacers," prevent lateral shifting of the separators - they also ensure the hoses stay put in cases of strong vibration and impact on the chain.



igus® E-Chains® with hydraulic hoses in a tree-stripping machine



Hydraulic hoses need more space:
20% all-around clearance

Strain Relief - Hydraulic hoses are most often stretched lengthwise during operation. This must be taken into account when applying strain relief. More hose length is factored in to allow the hose to "breathe", or "floating" strain relief must be implemented. In some cases, one-sided strain relief on the moving end can be tolerated.

Rollclip - In almost all cases, the broad, smooth and rounded surfaces of all igus® E-Chains® are sufficient to protect hydraulic hoses from abrasion. In extreme cases, the igus® Rollclip can be installed. The hoses come in contact with a series of polymer cylinders which rotate. "Extreme" cases include particularly soft materials, particularly narrow bending radii or highly dynamic loads. Over 95% of all applications can be solved without Rollclips.

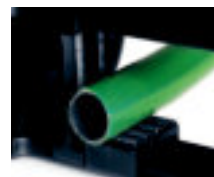

igus® Rollclip, detachable

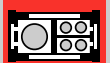
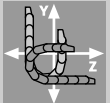



Ideally, the cables/hoses should be strain relieved at both ends of the E-Chain®. At the very least, they must be strain relieved at the moving end of the E-Chain®.

For more information on all igus® strain relief elements
▶ chapter 10

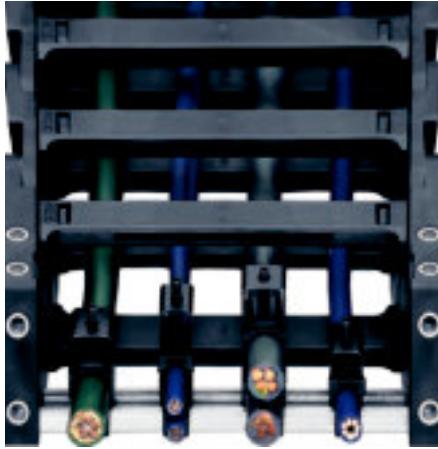

Strain relief in KMA mounting bracket with C-profile

Strain relief for electrical cables

Strain relief can consist of standard elements or can be custom-made. For most applications, our standard program of C-profiles with mounting brackets and space-saving Chainfix clamps can be used. We also offer simple strain relief solutions using cable tiewraps and tiewrap plates. In ideal cases, the cables should be secured at both ends of the E-Chain® with strain relief (in a few instances, strain relief at the moving end of the E-Chain® is sufficient - please consult igus® for these cases).

Minimum gap of the strain relief and the beginning of the bending radius

Tests on our premises and in field applications have shown strain relief located at the last bending point of the E-Chain® has no influence over the durability of igus® Chainflex® cables. It is possible, therefore, to integrate the strain relief with the mounting bracket. This space-saving option for strain relief is offered by igus® for almost all E-Chains®.

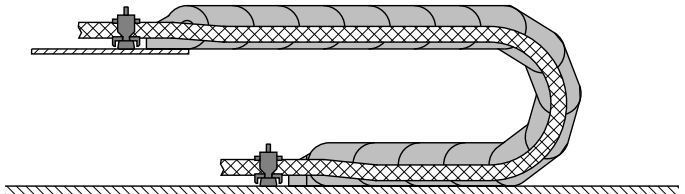

Ideal installation of cables in E-Chains®. Chainflex® cables can be directly strain-relieved in the mounting bracket (minimum gap to the last curved E-Chain® link is not necessary)!

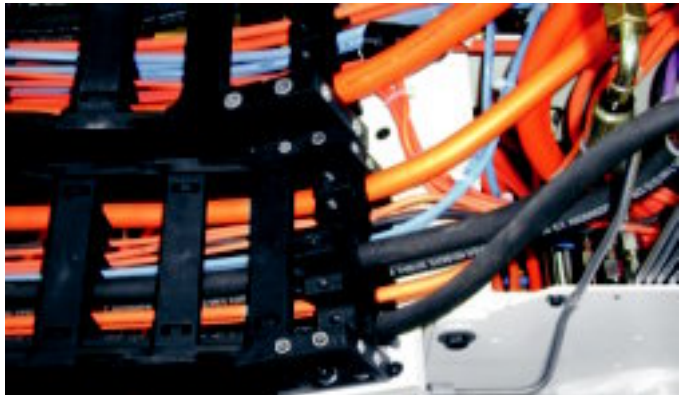

Chainfix strain relief in mounting bracket in practice - used here for cables and hoses

Features of chainfix clamps

- Optimal igus® Chainfix housing with reduced height
- Long service life for dynamic applications thanks to improved clamping elements
- Integration with KMA mounting brackets - saves both time and space during installation and available for complete systems with cables and strain relief
- Improved housing foot clamp for easy fit into C-profile
- Black housing and setscrews for attractive appearance
- Setscrews, tightened with Allen wrench, for easy installation
- Mark of the installation direction
- Now with better fixation due to optimized design



Tiewrap plates as individual parts

- Separate parts in switch cabinet construction or machine assembly
- Strain relief accessory for igus® E-ChainSystems®
- Attachment to mounting brackets
- Integration into the C-profile of KMA (polymer/metal mounting brackets)



Tiewrap plates with clip-on connection for the C-profile

The plates **3050.ZC** and **3075.ZC** can be clipped directly into the C-profile without bolts or any extra hardware. Clip-on tiewrap plates can be released and repositioned with just a screwdriver used as a lever.



Chainfix clip - modular snap-on strain relief device

Chainfix clip is a series of clamps and bottom parts made of plastic for cable diameters ranging from 4 mm to 24 mm. Chainfix Clip is available for C-profiles, also suitable for assembly in the KMA mounting brackets and clip-on strain relief for cross bars

- Quick assembly without any tools
- 2 and 3 layers on top of one another possible
- Each layer can be detached and changed later on
- High tensile forces in case of single-layer installation, decreasing with the number of layers

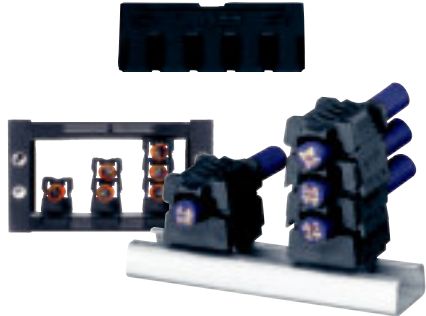

Chainfix nugget - for top hat rail and C-profile

- **Option 1:** completely simple and universal cable fixation, for diameter with \varnothing 20 mm and \varnothing 30 mm
- **Option 2:** Fastening through clipping onto standard top hat rail
- The smart helper for electricians in the machine building industry
- Accessory for all KMA with integrated C-profile
- Strain relief for top hat rail
- Easy to assemble, without any screws and tools
- Adjustable to every E-Chain® filling
- Very small space requirement
- Easy strain relief due to fixation with pre-harnessed cable strap



Strainrelief separator

- Can be integrated in mounting bracket
- Strain-relief separator can be positioned as required
- Double strain relief possible
- Easy installation, cost-effective
- For Series E6,29, 2600/2700 (other Series upon request)



Design
Strain Relief

Phone +49- (0) 22 03-96 49-800
Fax +49- (0) 22 03-96 49-222

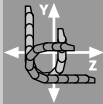



Technical environment:

- Fire resistance
- Radiation
- Weathering
- Cold, heat
- Explosion areas
- Vacuum
- Hot chips
- Dirt, dust
- Cleanroom
- Chemicals



igus® factory - automatic compounding and conveyor belt for igumid G

Technical environment and igumid G

The igumid G material, from which igus® E- Chains® are made, possesses the following wide-ranging features to cope with a variety of environments: the ability to handle pressure and strenuous loads, abrasion resistance, sturdiness, stable behavior at high and low temperatures, and suitability for outdoor use. Numerous application examples, from refrigerator blocks to steel mills, prove this. In extreme cases, we also offer modifications and other igus® compounds as a solution. Please consult igus®.

Resistance to radiation

igumid G is very resistant to high-energy radiation. Under gamma radiation, in the range of 8×10^4 rd, the mechanical properties of igumid G change very little.

Flammability of igumid G

The flame-retardant characteristics of igumid G can be described using various classifications: Test procedure VDE 0304 parts 3-5.70 - classification IIc. Tested according to UL 94 "Standard Tests for Flammability of Plastic Materials for Parts in Devices and Appliances" classification 94 HB for 3.2 and 1.6 mm thickness of the body. Tested according to DIN 4102 "Fire Behavior of Building Materials and Parts" classification materials class B-2. For further requirements, please consult igus® for special solutions, such as materials with self-extinguishing properties (UL V2 or UL V0). All E-Chains® (except for the Easy Chains® and Series 14) are made of from igumid G.



**igumid G has the classification UL 94 HB.
igumid NB has the classification
UL 94 V2. UL 94 V0 upon request**



**igumid G:
UL 94 HB**

**igumid NB:
UL 94 V2
UL 94 V0 (upon request)**



This robot is used for test purposes in British nuclear power plants

Flammability of igumid NB

All Easy Chains® and Series 14 Chains are made from the flame-retardant igumid NB material. These chains have the following flame-retardant classifications: ● UL 94 classification - V2 ● VDE 0304 Parts 3-5.70 classification - IIb ● DIN 4102 flammability of materials - B2 ● Please consult igus® regarding material availability "V0"



igumid G:

- UV-resistant
- Temperature range from: -40°C (40°F) to +120°C (248°F)

Temperature resistance

igumid G is very suitable for outdoor applications. In our experience, the mechanical properties of the E-Chain® are not impaired. igumid G is also UV-resistant. igus® E-Chains® are used in applications as cold as -40°C (40°F). Installation may be eventually compromised at temperatures below -25°C (-13°F). In such cases, we offer special solutions made from cold-elastic materials. 120°C (248°F) continuous temperatures are possible. However, the mechanical values are reduced and the service life is impaired.



Live broadcast from the Winter Olympics in Lillehammer - 75 m travel at -25°C (-13°F)



ESD & ATEX

Special ESD products and ESD tools must be used in numerous industrial sectors in order to protect sensitive electronic components against electrostatic discharge. Consequently an electrostatic discharge function applies in particular to energy ducting systems with their central role in automated sequences. igus® has developed the ESD E-Chain® for these demanding applications. They are made of material igumid ESD which immediately discharges



More ESD and ATEX information:
www.igus.eu/atesx



The hue of igumid ESD approximately corresponds to RAL 7015 slate-gray

permanent electrostatic charges in controlled manner. igumid ESD consists of the igus® E-Chain® material which has been tried and tested for over 35 years now in millions of applications with special additives. These additives provide the required properties and, in **mechanical** requirements, even exceed the standard material. Thus, for instance, the somewhat higher rigidity and the approx. 15% lower density can be used to implement a longer unsupported length, depending on application. The ESD E-Chain® features an even longer service life owing to the material. Unlike temporarily acting, applied conductive coatings or volatile, incorporated antistatics, the additives used provide durable and "maintenance-free" conductivity. One other advantage is the resistance to adverse ambient conditions.



igusid ESD with PTB certificate - We have received an official comment from the German National Standards Laboratory (PTB) on material igumid ESD and we are able to provide you with a copy on request

System E6 - 2nd Generation ESD Chains without pin and bores, long-term conductivity guaranteed

For many years, safety in hazardous areas and ESD protection in sensitive production areas have been given high priority at igus®. Since 1992, E-Chains® have been manufactured from our special "GC" material. Certified since 1994 by PTB (German federal office for Physics and Technology), the material was modified in 2002. In spite of homogeneous conductivity of the material, common pin/bore design chains can hardly maintain their conductivity within normed conductivity tolerances in the long term.

- Constant long term conductivity values
- No contact surface wear
- Proven standard product, now also conductive
- Cycle life in lab test ≥10 Million cycles (more upon request)
- Underlies heightened QC procedures, with and without mounting brackets and in various install modes
- IPA Fraunhofer institute certifies "Level 1" discharge performance, acc. to SEMI E78-0998 ESD, even for off-the-shelf standard E6 material.

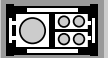
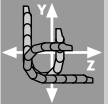

igus® goes clean room - qualification of E6 and other igus® E-Chains®

In many applications where cumbersome special solutions are used, a simple standard E-Chain® can be used instead. A comprehensive test program was devised and performed for both gliding use and unsupported use. For many applications, the E-Chains® in special materials are practically abrasion-free. Detailed test results are available upon request. IPA tests confirm that standard igus® E-Chains® meet clean room requirements. "Tested and certified as very good!" E-Chains® for clean room applications on the test stand Clean room environments demand very high wear resistance of moving parts. E-Chains®, for example, must be very wear resistant, in order to meet norm requirements for such a sensitive environment.

IPA Fraunhofer Institute has tested igus® Series E3, E6 and Easy Chain® as follows:

- ISO class 1, as per stringent norm DIN EN ISO 14644-1 for System E3, Series E3.15.040.075.0 at v = 0,5 m/s, 1 m/s, 2 m/s
- ISO class 1, as per stringent norm DIN EN ISO 14644-1 for System E6 - special material*, Series E6.29.060.150.0.CR at v = 0,5 m/s, 2 m/s
- ISO class 3, as per stringent norm DIN EN ISO 14644-1 for System E6 - standard material, Series E6.29.060.150.0 at v = 0,5 m/s, 1 m/s, 2 m/s
- ISO class 2, as per stringent norm DIN EN ISO 14644-1 for Series Easy Chain® E14.3.038 at v = 1 m/s

Phone +49- (0) 22 03-96 49-800
Fax +49- (0) 22 03-96 49-222

Test setup: Particle generation measurement



Measurement result: Particle generation E14.3.038.0

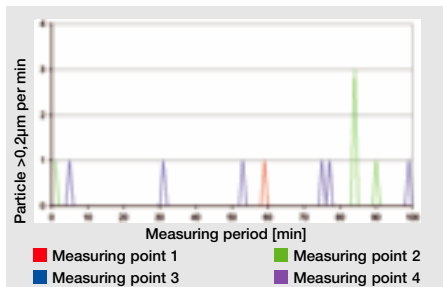

ISO Class 2

acc. to DIN EN ISO 14644-1
for E14.3.038.0

Test setup: Field strength measurement



Measurement result: Field strength E6.29.050.055.0

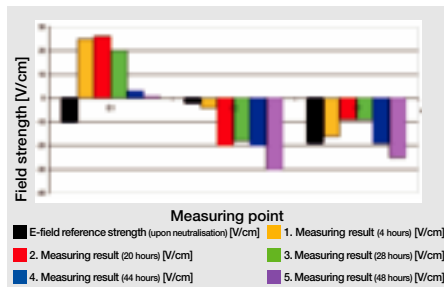

Level 1

ESD-compatibility acc. to SEMI E78-0998
for E14.3.038.0 and E6.29.050.055.0

igus® GmbH
51147 Cologne

Classification chart

Class per DIN	Equivalent to VDI 2083	Equivalent to US Fed.Std. 209E	Classification Series	Speed [m/s]
EN ISO 14644-1	VDI 2083	US Fed.Std. 209E		
ISO class 1	no comparable classification	no comparable classification	E3.15.040.075.0	0,5 / 1,0 / 2,0
ISO class 1	no comparable classification	no comparable classification	E6.29.060.150.0.CR*	0,5 / 2,0
ISO class 2	no comparable classification	no comparable classification	E14.3.038.0	1,0
ISO class 3	class 1	class 1	E6.29.060.150.0	0,5 / 1,0 / 2,0
ISO class 4	class 2	class 10		
ISO class 5	class 3	class 100		
ISO class 6	class 4	class 1.000		
ISO class 7	class 5	class 10.000		
ISO class 8	class 6	class 100.000		

*special material "clean room"

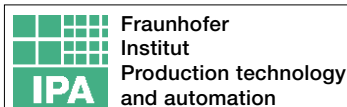

Internet: www.igus.eu
E-mail: info@igus.de

Splatter, hot chips

Laboratory tests and numerous field applications prove that igus® E-Chains® and E-Tubes reliably protect cables in welding robots and machine tools since 20 years. E-Tubes made from the igus® igumid HT material are resistant against burnt-in chips up to 850°C (1,562°F), no chips do stick. This opens new possibilities for replacing difficult-to-handle steel tubes. Program range: All standard E2 and E4 E-Tube sizes, upon request. Please note: igumid G in direct contact with large amounts of melted aluminum is not recommended.

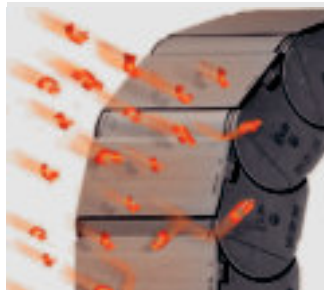

E-Tubes that repel hot chips, up to 850 °C with the igus® "igumid HT" material.

Further Information ► www.igus.de/en/HT

Dirt, dust, chips

Materials and design make igus® E-Chains® excellent problem-solvers in harsh environments. Experience and application references are available upon request. Please consult igus® with your application.

Vacuum

igus® E-Chains® made of igumid G can be used in vacuum applications. Very little outgassing occurs.

Chemical resistance

igumid G is resistant to fuel, lubricants, oils, fats, alcohol, ester, ketone, and aliphatic and aromatic hydrocarbons. Oxidants and acids are damaging. The table ► **page 1.39** shows an excerpt of the precise details concerning resistance to chemicals. Acid-resistant E-Chains® are available upon request.

Coolant resistance

E-Chains® and E-Tubes have proven **resistant to cooling agents**. However, we are always willing to perform individual tests if you have particular problems or advanced developments. **Table on resistance to chemicals** ► **page 1.39**.



igus® E-Tubes in the chip area of machine tools



Also hot asphalt is no problem for igus® E-Tubes, Series R48



Compost sludge - numerous related references available upon request



igus® - Experience with

Dust, dirt, mud, compost, wood, textile fibers, paper dust, abrasive paste, cooling agents, glass sand, glass splinters, coal dust, sand, corundum and much more.



Particularly suitable E-Chain®

Series for dirt, dust, chips

- E4/4HD ► chapter 7
- System E4 ► chapter 7
- E2 E-Tubes ► chapter 6
- E2/000 ► chapter 5

Design Technical Environment

Phone +49- (0) 22 03-96 49-800
Fax +49- (0) 22 03-96 49-222

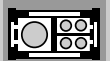
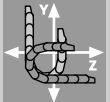

Plastics for longer life® - igus® know-how in polymer materials

Each year, igus® engineers develop more than one hundred new plastic compounds and test igus®-products in more than 5,000 experiments per year. That's how in recent years they have built an extensive database of the tribological properties of polymers. This database makes it possible for us to assess better most of the applications in advance and provide our customer with confidence during use. Our calculations and analyses are based on the result of ongoing practical tests in our Technical Center and our experience with gliding applications. The focal points of our tests are push-pull forces, friction values and abrasion under widely varying conditions and speeds, as well as factors such as dirt, weathering or impact and bumps. We test all system components such as cables, hoses, strain relief and other accessories, in addition to the E-Chains® or E-Tubes and Guide Troughs.



Material data igumid

Material data table	Units of Measure	Values igumid G	Values igumid NB	Values igumid ESD	Values igumid TE
Yield stress	MPa	190/130	78/40	-	-
Elongation at break	%	004/006	20/210	-	-
Elasticity module (tensile test)	MPa	9000/7000	2900/1200	-	-
Impact strength +23°C	kJ/m²	55/65/55	not broken	-	-
Impact strength -40°C	kJ/m²	40	90	-	-
Ball indentation hardness H 961/30	MPa	230/160	150/60	-	-
Heat conductivity W/k * m	Ω/k * m	0,23	-	-	-
Dielectric constant	10³ Hz	3,9/6,2	-	-	-
special transitional resistance	Ω*cm	>10¹¹	>10¹¹	<10⁹	-
Impact strength density 0,6-0,8 mm	kV/mm	80	16-18	-	-
Surface resistance ROA	Ω	>10¹¹	>10¹¹	<10⁹	-
Density	g/cm³	1,37	1,14	1,2	1,02
Absorption of humidity 23/50 RF	%	1,4	3,4	1,9	1,1
Coefficient of sliding friction	-	0,3	0,3	0,3	0,3
Fire resistance as per VDE	-	FH2	-	-	-
Fire resistance as per UL	-	HB	V-2	HB	HB
Color	-	■ = RAL 9004	■ = RAL 9004	■ = RAL 7015	■ = RAL 9004
Maximum water absorption	-	5,6	7,6	7,3	-
Limit of elasticity in bending	MPa	7.800	3.000	9.500	-
Bending strength	MPa	240	120	230	-
Hardness Shore D	-	79	79	83	-
Upper long-term application temp.	-	120°C (248°F)	80°C (176°F)	80°C (176°F)	70°C (158°F)
Upper short-term application temp.	-	180°C (356°F)	170°C (338°F)	150°C (302°F)	140°C (284°F)
Lower application temp.	-	-40°C (-40°F)	-40°C (-40°F)	-40°C (-40°F)	-40°C (-40°F)

Medium	Concentration Weight %	Material igumid G /NB
Acetone	100	+
Formic acid (aqueous)	2	○
Ammonia (aqueous)	10	+
Gasoline	100	+
Benzole	100	+
Bitumen	100	○
Boric acid (aqueous)	10	+
Butyric acid	100	○
Calcium chloride (aqueous)	Sat. aq. sol.	+
Chlorinated hydrocarbons		+
Chlorine water	Sat. aq. sol.	-
Chromic acid (aqueous)	1	○
Diesel oil	100	+
Iron II cyanide	30	○
Acetic acid	2	+
Color		+
Fats, cooking		+
Fluorinated hydrocarbons		+
Formaldehyde (aqueous)	30	○
Hydraulic oils		+
Caustic potash	10	+

Resistance classes

- + = resistant
- = conditionally resistant
- = non-resistant

Medium	Concentration Weight %	Material igumid G /NB
Potassium carbonate (aqueous)	60	+
Potassium sulphate (aqueous)	100	+
Methyl acetate	100	+
Milk		+
Mineral oil		+
Sodium carbonate (aqueous)	50	+
Oil, cooking		+
Oil, lubricating oil		+
Oleic acid	100	+
Paraffin oil		+
Perchloroethylene	100	+
Polyester resins (with styrene)		+
Propane gas		+
Mercury		+
Hydrochloric acid	pH2	○
Hydrochloric acid	2	-
Hydrochloric acid	10	-
Ink, printing ink		+
Vaseline		+
Tartaric acid		○
Zinc sulfate (aqueous)	10	+

Sat. aq. sol. = saturated aqueous solution

Conc. aq. sol. = concentrated aqueous solution

The values specified are values determined by laboratory tests and are material-specific. All specifications apply to black E-Chains®.

Colors and special solutions

All E-Chains® made from igumid G are available in the colors listed below. Additional colors are usually feasible. Colored E-Chains® are basically not available from stock. Contact igus® for more information regarding colored E-Chains®. All values listed apply to stability (e.g. unsupported lengths) and material characteristics for black E-Chains® only. Colored E-Chains® may have altered characteristics. This also applies for all E-Chains® made from special materials (e.g. conductive E-Chains® made from igumid GC or other special materials).

"RAL" Numbers

	Black	= RAL 9004	Index .0
	White	= RAL 9003	Index .1
	Violet	= RAL 4008	Index .5
	Yellow	= RAL 1018	Index .4
	Orange	= RAL 2003	Index .2
	Red	= RAL 3002	Index .6
	Blue	= RAL 5005	Index .8
	Green	= RAL 6011	Index .7
	Grey	= RAL 7023	Index .3 for Chains
	Dusty grey	= RAL 7037	Index .3 for Tubes
	Agate grey	= RAL 7038	Index .11
	Light grey	= RAL 7035	Index .14
	Black grey	= RAL 7021	Index .13
	Slate grey	= RAL 7015	only ESD-E-Chain®
	Yellow/black	-	Index .9



Colors for design coding

Standards and Certificates
Material Data igumid & Colors

Phone +49- (0) 22 03-96 49-800

Fax +49- (0) 22 03-96 49-222

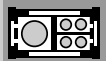
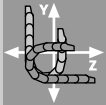



Quality inspection of every E-Chain® production

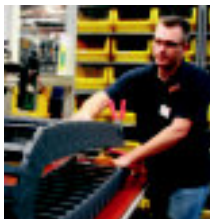

Test location for ESD-E-Chains®



Chainflex® cables with many certificates for e.g. DESINA



Noise level tests in igus® own acoustic laboratory

Examples for test certificates and approvals

ISO 9001

igus® has been certified since November 1996

TÜV construction test

igus® E-Chains® and E-Tubes are construction-tested by TÜV Rheinland. igus® E-Chains® were tested and passed by TÜV Rheinland in accordance with the valid machine guidelines. As a result, the user of igus® E-Chains® need not worry about meeting CE requirements through testing for this portion of the machinery. **The construction test 2PFG 1036 / 10/97 for protective equipment includes the following:**

- Application and safety
- Assembly
- Fatigue strength
- Resistance to external influences
- Sharp corners and edges

ESD/ATEX

igus® E-Chains® made of standard material igumid G correspond to the German federal office of Physics and Technology (PTB) to classification Ex II 3 GD according to ATEX-RL 94/9/EG. igus® E-Chains® made of igumid ESD correspond according to the German federal office of Physics and Technology (PTB) to classification Ex II 2 GD according ATEX-RL 94/9/EG.

IPA Cleanroom

A lot of E-Chains® are suitable for the use in cleanrooms according to DIN EN ISO 14644-1. Confirmed by the IPA Fraunhofer Institute.

UL, CSA, CEI, CE and VDE

All igumid-materials for E-Chains® and E-Tubes have got the UL-material approval. The material igumid NB has got the fire protection class approval IIb according to the test VDE 0304 Part 3/5.70, the approval V2 according UL 94 and the construction material class B2 according DIN 4102.

Interbus, CC-Link and DESINA

Chainflex®- cables are produced according to a lot of international standards: **Interbus certification:** For Interbus certification of certain CF11 bus cables. **CC-Link:** with CC-Link approval. **DESINA:** Many Chainflex® cables are Desina-compliant.

Clearly quieter

igus® E-ChainSystems® are clearly quieter. In the acoustic laboratory of the TÜV and the igus® GmbH different E-Chains® were compared. The igus® Systems E3, E6 and E4/00 (Series E4/101) are measurably (and clearly) quieter than other products of comparable size (see also noise-optimized E-Chains® ► [page 1.11](#))

igumid

The material igumid is free from toxins, according 2002/95/EC (RoHS).

iF Design Award

16 iF Design-Awards since 1984



ReadyChain[®]

Plug and play E-ChainSystems[®]

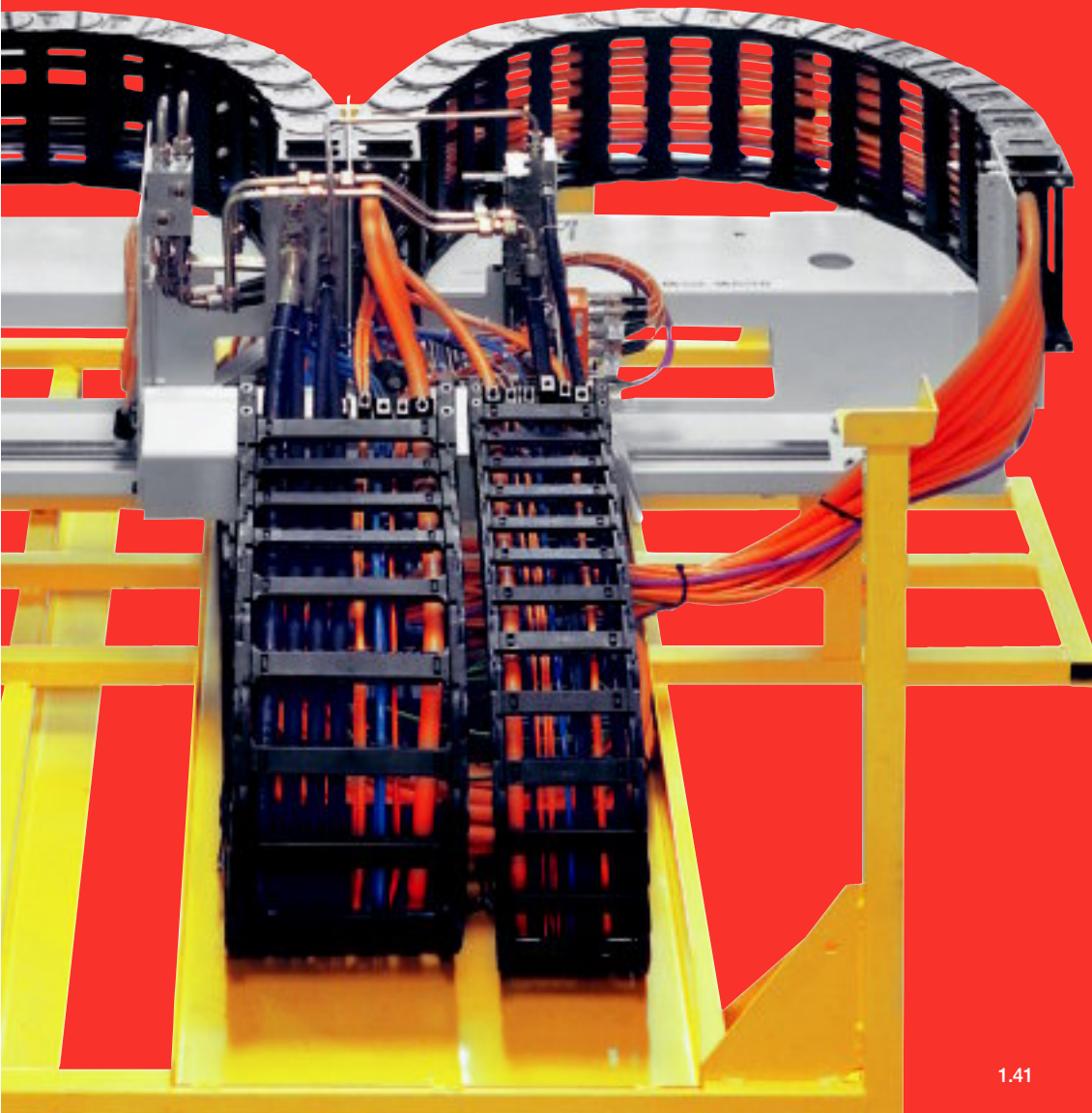

The advantages of plug and play E-ChainSystems® from igus®

- Increase your cash-flow
- Cover the fluctuations
- Reduce your throughput
- Minimize downtime
- Reduce number of purchase orders by about 75%
- Zero stock
- Modern equipment means low cost at highest quality
- Any system is checked in our test center
- More than 3,000 electrical components from stock
- Delivery with individual Plates and mounting parts
- igus® is certified according to DIN EN ISO 9001:2000
- ReadyChain®-factory with more than 80 experts
- Over 700 systems leave the 10 ReadyChain® factories worldwide every week
- Profit from our long experience acquired since 1993
- Worldwide service in more than 45 countries

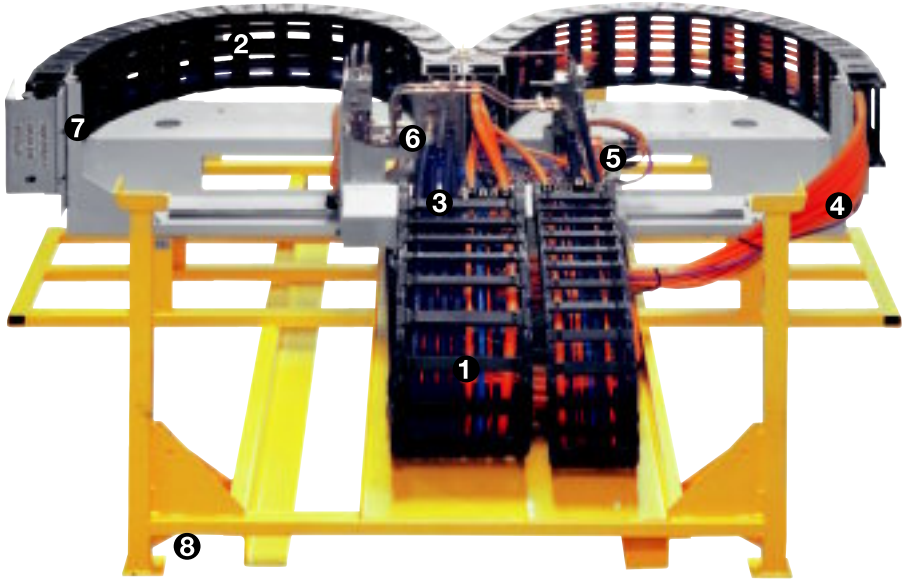

- | | |
|--|--|
| <p>1 Ordered cables and hoses within the E-Chain® using separators and shelves from igus®</p> <p>2 E-Chain®, specially designed for your machine</p> <p>3 Strain relief systems, specially designed for use in your machine</p> <p>4 Special cables and hoses, designed for E-Chains® and suited to your application</p> | <p>5 Connector components, preassembled according to specification standards of Siemens, Fanuc, SEW, etc.</p> <p>6 Hydraulic components, designed for your application</p> <p>7 Plates and mounting parts, optimized for the quick installation on your machine. Delivered ready to install.</p> <p>8 Installation and transport racks</p> |
|--|--|

igus® ReadyChains® increase your cash-flow

Whether major projects or simple, assembled E-Chains® - we save you costs, time and hassle through igus® ReadyChains®. Over 700 systems leave the 10 ReadyChain® factories worldwide every week. Profit from our long experience acquired since 1993, and increase your cash flow quickly and smoothly even for one-off systems.

- 1 Zero stock of cables, E-Chains® and connectors** - Forget storage of flexible cables, connectors and other parts with our fast delivery times. **Detailed information ► page 1.44**
- 2 Reduce throughput time by about 50%** - igus® delivers ready-made systems worldwide within 2-8 days of the guaranteed date. **Detailed information ► page 1.45**
- 3 Respond flexibly to order fluctuation** - With ReadyChains® you are always prepared for variations in demand. We help cover the fluctuations. **Detailed information ► page 1.46**
- 4 Minimize downtime** - Small things can cause big problems. Buying numerous single parts increases your inventory and the chances of problems. You will get a system solution with ReadyChains®. Any system is checked in our test center. igus® is certified according to ISO 9001. **Detailed information ► page 1.47**
- 5 Reduce number of suppliers and purchase orders by about 75%** - One order one invoice one delivery one partner. Don't care about looking for numerous parts from numerous suppliers. We have the knowledge to provide you quickly with the optimal parts. **Detailed information ► page 1.48**

You determine the degree of harnessing



Any degree is possible

We harness from simple E-ChainSystems® with pre-fitted Chainflex® cables to complex systems. These systems may include all cables and hoses (pneumatic, hydraulic), patch plugs, inner partitions, connecting elements and connecting parts as required.

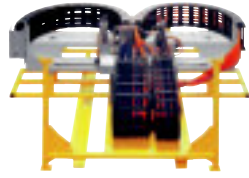

From easy to project

You determine the size



Any size is possible

Because of our upto-date production processes we can deliver fast and cost effective custom build or serial production products.

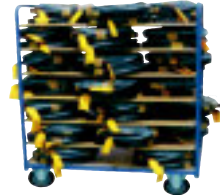

From one-off to serial production

You determine the travel length



Choose the travel length

ReadyChains® offers the whole spectrum of possible travels of the igus® E-Chains®. We harness anything from short to long travels. Safe transportation guarantees damage-free delivery of any lengths.



From short to long

Standardised ReadyChain®: Ready to fit



ReadyChain® "Basic"

Simple, prefabricated E-ChainSystem® including assembled cables without connectors, labelled and according to your specifications.

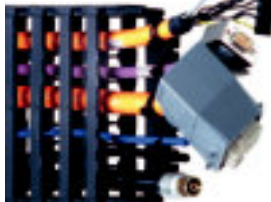

ReadyChain® "Standard"

Simple, prefabricated E-ChainSystem® including assembled cables with all connectors, labelled according to your specifications.

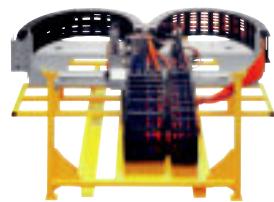

ReadyChain® "Premium"

A prefabricated E-ChainSystem® with cables of all kinds, as well as plugs, connectors and components. Special shafts and plain bearings machined according to your specifications.



1 Reduces your storage costs to zero for cables, E-Chains® and connectors

In Cologne, igus® manufactures its products on about 25,000 m² interior space. 80,000 products delivered off the shelf. Reduce your capital commitment and increase your cash flow with igus® ReadyChain®. Our large-volume material procurement saves you time and money, independent of serial application or individual projects. The complete component ReadyChain® reduces your storage and dispatching of E-Chains®, cables and plug connectors to a minimum, and at the same time reduces the number of your suppliers and orders by 75%. Make use of the experience of over 90 igus® ReadyChain® specialists in your own interest.



More than 70,000 E-Chain® components...

Phone +49- (0) 22 03-96 49-800
Fax +49- (0) 22 03-96 49-222



...more than 3,000 electrical components...

igus® GmbH
51147 Cologne



...more than 850 Chainflex® special cables...

Internet: www.igus.eu
E-mail: info@igus.de



...in the huge igus® cable store.

2 Cut your throughput times from days to hours

The throughput time of the assembly of complete E-ChainSystems® often takes several days. Reduce the throughput times to hours - with ReadyChain® from igus®.

ReadyChains® - Ready to fix and install

The delivery condition of your ReadyChain® is crucial for your in-house transport and installation. To bring the material into motion is one of our most important tasks for your operation. Experienced specialists from the igus® ReadyChain® project planning division would be glad to advise you in the definition of the component interfaces and on the design of the combined transport and installation aids.



Machining center - System E4/light, Chainflex® cables, mounting plates and igus® strain relief systems delivered ready to install



Racks for transport to and within your company



Large batch sizes for serial production



Installation-optimized delivery of an igus® ReadyChain®



ReadyChain® "from the roll". We supply your ReadyChain® for long travels on special cable reels



Defined picking order for your time-phased production



igus® ReadyChain® on mounting frames for lightning fast final assembly



3 Respond flexibly to order fluctuations

Utilize igus® manufacturing capacities

Transfer your capacity problems to us. The igus® ReadyChain® factory compensates for your order fluctuations with state-of-the-art production technology and specialized staff.

Respond flexibly and utilize our know-how

Flexible production planning Customers are guaranteed consistent quality at low costs. All employees are trained both for the ReadyChain® installation and for the cable assembly. Flexible production planning safeguards your delivery times



igus® ReadyChain®-factory: 80 experts
produce more than 700 systems per week



Special departments take
care of your individual project

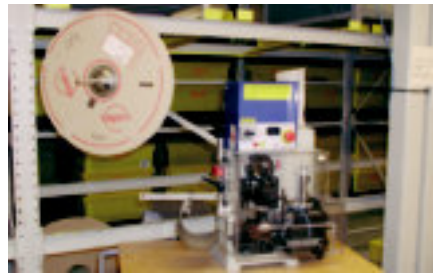

Automatic crimp machines guarantee
safe connections, rationally connected



The automatic cable stripping facility
allows cheap prices for highest quality



ReadyChain® large projects - Specially trained
employees accompany your project from start to finish



Cable handling
and measurement



Precision at every igus® workplace.
For batch applications and one-off projects

4 Minimize your machine downtimes

All components of the ReadyChain® undergo an extensive quality control and functional tests

Our quality assurance division subjects every ReadyChain® system to functional tests with special testing facilities before they are dispatched. All ReadyChain® systems and components are tested in the igus® laboratory. Over 2,000 tests are conducted with E-ChainSystems® and cables every year. With an igus® system guarantee (according to application), we offer assurance on the safety and quality of your ReadyChain®. igus® is certified according to DIN EN ISO 9001:2000



Component test - tensile strength and shear force test of igus® E-Chain®. $v = 10 \text{ m/s}$, $a = 200 \text{ m/s}^2$



Computer-aided, high-voltage test equipment ensure tested quality



Test adapter for the testing of any ReadyCable®



igus® climate chamber - E-Chain® and Chainflex® test runs possible at -40° (-40°F) to $+60^\circ\text{C}$ (140°F)



Component test - torsion tests for cables



All tests are logged and electronically stored



Quality from the beginning with high-tech machines



5 Reduce the number of supplier and orders by 75%

One order - One invoice - One delivery - One partner

Reduce your planning costs. We relieve you of as much work as possible. Our trained staff will step by step support a smooth development of your ReadyChain® project. We can demonstrate all advantages of ReadyChain® for your business. We will visit your site discuss the application and collect all required data for your ReadyChain® project



igus® staff at the "on-site inspection" of a plant



Planning with special software tools



Drawing up detailed design worksheets

Chain, cable, assembly
Order of components
with ONE part number



Receipt of components

Transport to the machine
and ready-to-use installation



We can submit a complex offer within a week

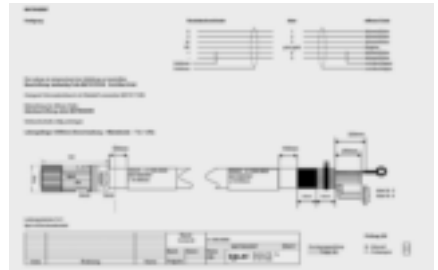

Precise job and grouping of cables planning for each cable



Pre-harnessed E-Tube for machining centers.
E-Tube protect cables against dirt and chips



On-site assembly of an igus® ReadyChain®. igus® delivery scope includes machine parts, saving time and money



Horizontal machining center - harnessed with igus® E-ChainSystem® E4/4, Chainflex® cables and accessories



Machining center - System E4/light E-Chains®, Chainflex®-cables, metal parts and igus® strain relief



Flexible response to order fluctuations:
Have the complete subassembly built at igus®



Tool magazine - igus® E2/000 E-Chain® harnessed with Chainflex® CF27, CF11 and CF.INI cables

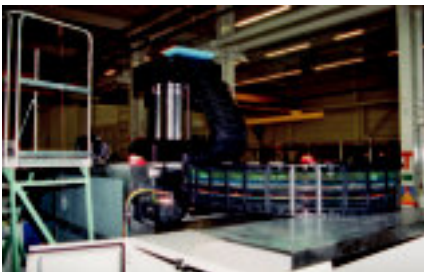

ReadyChains®, connected through a junction box, delivered by igus®, make installation even easier



Harnessed igus® E4 E-Chains® on an X/Y unit in the textile industry with high cycle counts

ReadyChains®

Phone +49- (0) 22 03-96 49-800
Fax +49- (0) 22 03-96 49-222



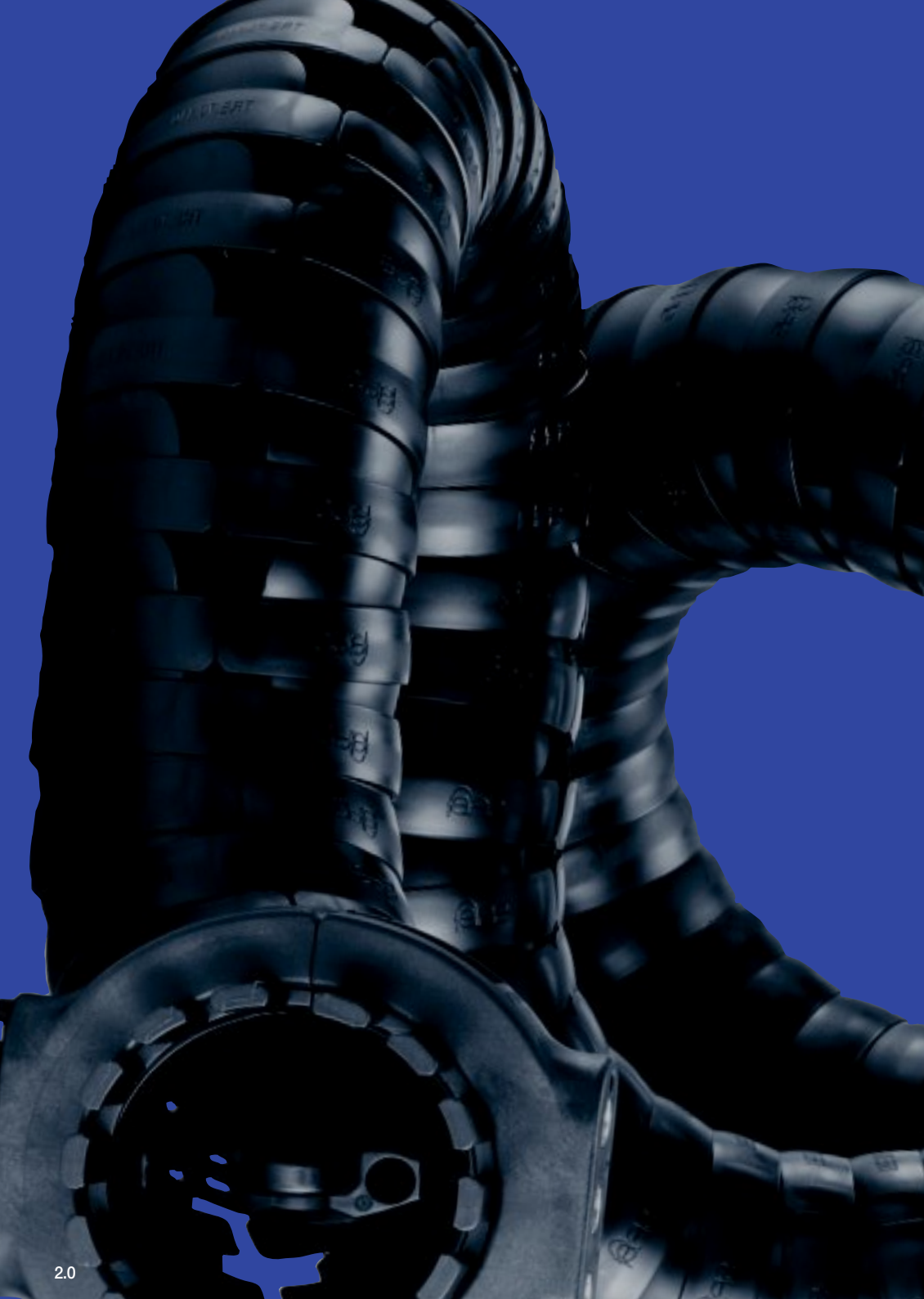

Triflex[®] R Triflex[®] TwisterChain[®]



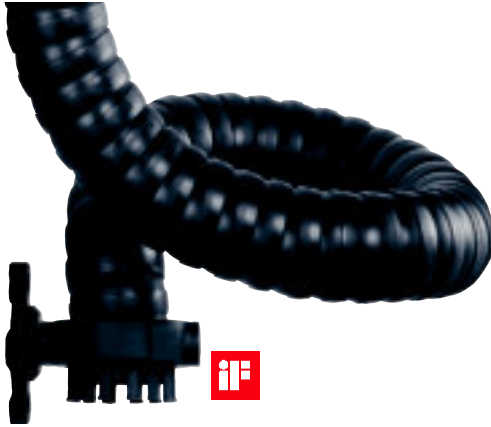

The igus® Triflex® R system is the first choice for multi-axis-robots. Three variants are available: TRC: Closed design, TRE: "Easy" design, easy to fill from outside, TRL: The "light" variant of the "Easy" design. It is universal for reliable energy supply, in general machinery with multi-axis (3D) movements

TRC- closed design

- Energy supply for multi-axis 3D-movements
 - High torsional stability
 - Easy shortening and lengthening
 - Small bend radius
 - High tensile force capacity
 - If a smooth and robust exterior is needed
- ▶ from page 2.12

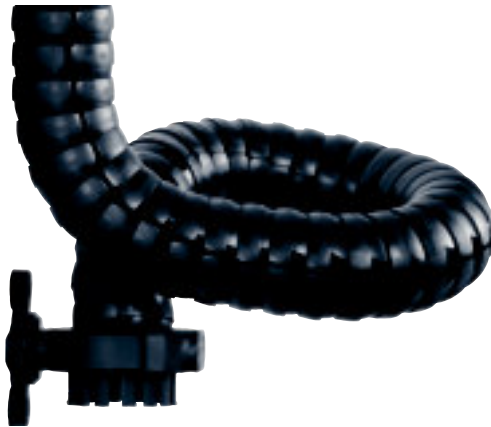

TRE- "Easy" design

- Cables are easy to install and replace
 - Energy supply for multi-axis 3D-movements
 - High torsional stability
 - Easy shortening and lengthening
 - Small bend radius
 - High tensile force capacity
- ▶ from page 2.14



TRL- light design

- If a light weight, cost-efficient and easy to fill 3D-E-Chain® is necessary
 - If a 3D-E-Chain® for easy 3D-movements is needed
 - If an easy to use 3D-E-Chain® is needed
 - If a 3D-E-Chain® for nonrobotic-applications is needed
- ▶ from page 2.16



The Triflex® series was developed to realize safe energy supply in the case of multi-dimensional movements. In doing so the flexibility of a hose was combined with the stability of an E-Chain® and its defined radii. 2 versions are available: Easy to fill **Easy Triflex®** and the closed **Triflex®**.

Simple filling - Easy Triflex®

- If easy filling and complex movements are necessary
 - Very fast cable assembly with "Easy" principle
 - Simple filling from two sides
 - For reparations or supplements of existing Triflex®-Systems
 - For simple 3D-applications
- ▶ from page 2.30



Closed version Triflex®

- For applications with one, two or three directions of motion (combined circle- and stroke-movements)
 - Completely enclosed - protection against dirt and chips
- ▶ from page 2.42



Rotary motion with TwisterChain®

The TwisterChain® product line offers the biggest selection for rotary movements. TwisterChain® solutions are available with Guide Troughs:

TwisterChain®

- Modular interior separation
 - Crossbars can be opened on both sides
 - At rotating speeds up to 90°/s
 - igus® TwisterChain® for circular motions up to 540° (with special attachments)
- ▶ from page 2.56

Triflex® R



Triflex® R - 3-dimensional E-Chains® for robots

Triflex® R (R for "round") is the third generation of multi-axis E-Chains®. Design features include:

- Optional fibre rod for spring loading of the Triflex® R
 - Approximately $\pm 10^\circ$ twist per chain link
 - High tensile strength of the ball-and-socket joint
 - Easy assembly and modification due to single moulded link design. No support elements (steel cables, spring suspensions etc.) are necessary
- The Triflex® R product family now comprises more than 100 components meeting all requirements ranging from those of small palleting robots to large welding robots.

Typical industries and applications

- Robotics/Automation
- Machine tools
- Handling machines - 6-axis
- Packaging machines
- General mechanical engineering, etc.



Video on the web ▶

www.igus.de/TriflexR_Film



IF-Design awards for
TRC and TRL-design



Series TRC - Electrically conductive
ESD/ATEX version upon request



Cleanroom suitability
upon request



UL94-V2
classification



Triflex® RS - universal module for safe realisation of complex robotic movements

Triflex® RS attaches to the existing fixation point on the robot. Thanks to its low installation height, Triflex® R runs parallel and tightly against the robotic arm. Even applications with heavy space restrictions can be realized.



Video on the web ▶
www.igus.de/RS_Film



Fiber rod module for directed pretension and universal assembly kit for multifaceted adjustments

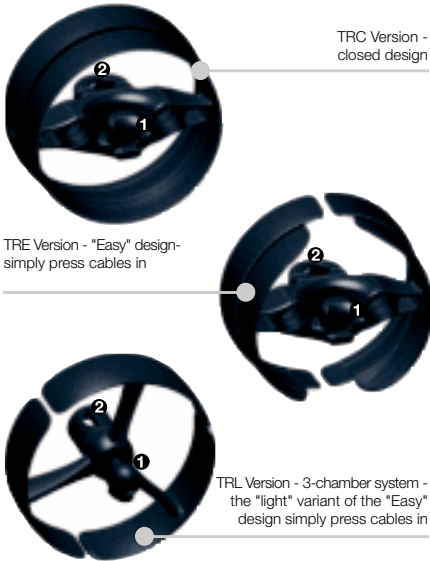

Triflex® R Set - Routed closely on the robotic arm for extreme flatness

Select this system for:

- The first choice for multi-axis-robots
- **Three variants are available:** **TRC:** Closed design, **TRE:** "Easy" design, easy to fill from outside, **TRL:** The "light" variant of the "Easy" design
- Universal for general machinery
- Multi-axis (3D) movement
- High torsional stability
- Easy shortening and lengthening
- Smooth interior and exterior edges (TRC)
- Small bend radius
- ① Ball-and-② socket principle
- Cables easy to assemble and to replace (TRE/TRL-version)
- Triflex® R-Set - compact module for all movements on robots, which can be fixed on existing fastening points
- TRL - one piece, thus very lightweight
- High tensile strengths without additional elements like steel cable and spring elements etc
- You can find more technical data about the material, chemical resistance, temperatures ► **chapter design, from page 1.38**

Selection table

Series	Inner height		max. cable ø		Outer width Ba [mm]	Bending radii R [mm]	Pitch [mm]	Links per m	Page
	Bi 1	Bi 2	d1	d2					
"TRC" - Triflex® R closed design, dirt-resistant									
TRC.30	12	10	10	8	34,5	50	11,3	89	2.12
TRC.40	15	13	13	11	43	58	13,9	72	2.12
TRC.60	22,5	19,5	20,5	17,5	65	87	20,4	49	2.12
TRC.70	28	24	26	22	81	110	25,6	39	2.12
TRC.85	33	28	31	26	94,5	135	30,6	33	2.12
TRC.100	37,5	32,5	35,5	30,5	108	145	34,5	29	2.12
TRC.125**	43,3	43,3	41	41	135	182	44,6	23	2.12
"TRE" - Triflex® R "Easy" design for fast installation of conduits									
TRE.30	12	10	10*	8*	34,5	50	11,3	89	2.14
TRE.40	15	13	13*	11*	43	58	13,9	72	2.14
TRE.60	22,5	19,5	20,5*	17,5*	65	87	20,4	49	2.14
TRE.70	28	24	26*	22*	81	110	25,6	39	2.14
TRE.85	33	28	31*	26*	94,5	135	30,6	33	2.14
TRE.100	37,5	32,5	35,5*	30,5*	108	145	34,5	29	2.14
TRE.125**	43,3	43,3	41*	41*	135	182	44,6	23	2.14
"TRL" - a light and economical alternative with an "Easy" design									
TRL.30	12	10	10*	8*	34,5	50	11,3	89	2.16
TRL.40	15	-	13*	-	45	58	13,9	72	2.16
TRL.60	23	-	20,5*	-	65	87	20,4	49	2.16
TRL.70	28	-	26*	-	81	110	25,6	39	2.16
TRL.100	38	-	35,5*	-	108	145	34,5	29	2.16

* For quick and easy insertion / removal of cables using the Easy Chain® principle, we recommend a maximum cable diameter of 70% of the specified value.

** TRE.125/TRC.125 - max. cable diameter Ø 41 mm. Max. cable diameter changes to

Ø 36 mm only, if shortening/lengthening of a filled Triflex® R is required - available from autumn 2009

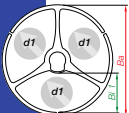
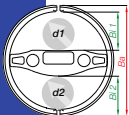
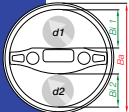

Assembly | TRC.30 · TRC.40 · TRC.60 · TRC.70 · TRC.85 · TRC.100



Hold two pieces together at inner radius and move socket up against the ball's wedged end

Separating | TRC.30 · TRC.40 · TRC.60



Bend Triflex® R into its radius and twist apart, counter-clockwise

Separating | TRC.70 · TRC.85 · TRC.100

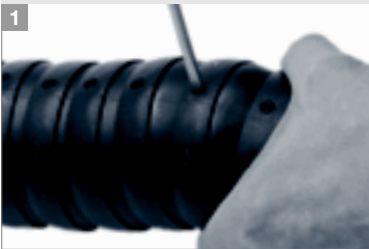

Insert screw driver into the opening of the socket from the top. Then twist apart, counter-clockwise

Assembly | Separating | TRC.125



Connector principle = Ball head clevis joint (similar to the proven trailer hitch design)
Improved assembly/disassembly for large sizes. Faster assembly with less effort



Assembly | TRE.30 · TRE.40 · TRE.60 · TRE.70 · TRE.85 · TRE.100



Hold two pieces together at inner radius and move socket up against the ball's wedged end.
Push until a clicking sound indicates a secure fit of socket onto the ball (E-Chain® section exposed for the purpose of demonstration)

Separating | TRE.30 · TRE.40 · TRE.60

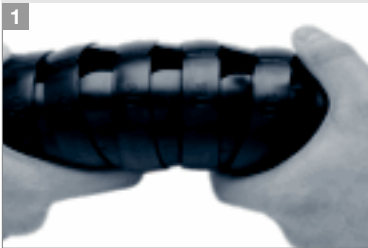

Bend Triflex® R into its radius and twist apart, counter-clockwise

Separating | TRE.70 · TRE.85 · TRE.100



Insert screw driver into the opening of the socket from the top.
Then twist apart, counter-clockwise

Filling | TRE.30 · TRE.40 · TRE.60 · TRE.70 · TRE.85 · TRE.100



Easy to fill - simply press cables in...

...and easy to take the cables out



Assembly | TRL.30 · TRL.40 · TRL.60 · TRL.70 · TRL.100



igus® Triflex® R TRL - very easy to assemble - simply press the ball into the socket, ready!

Separating | TRL.30 · TRL.40 · TRL.60 · TRL.70 · TRL.100



Just twist the ball slightly to remove it from its socket

Filling | TRL.40 · TRL.30 · TRL.60 · TRL.70 · TRL.100



Easy to fill - simply press cables in...

...and easy to take the cables out

Installation | Mounting bracket in this case, a "light" bracket with an intermediate connection



Easy assembly - to open, push a screwdriver against one side and prise apart



● ● ● Price index

Clean-Room Cleanroom suitability upon request

IF-Design awards for Triflex® R design

EX Electrically conductive ESD/ATEX version upon request

UL UL94-V2 classification

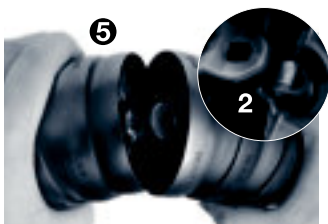

Easiest possible assembly and dismantling afforded by the ball-and-socket principle



When to use the Series TRC:

- If a secure cable guide is required for multi-dimensional (3D-) movements
- If high torsional stability is required
- If the system has to be shortened or lengthened easily
- If a small bending radius is required
- If high tensile strength is important



When not to use it:

- For circular movements with high loads
 - ▶ **System TwisterChain®**, from page 2.56
- If simple filling is required
 - ▶ **Triflex® R - TRE**, page 2.14
- If a more simple and cost effective solution is required
 - ▶ **Triflex® R - TRL**, page 2.16



- 1 Able to move multi-dimensionally - High degree of flexibility, even on the 6th axis. Twist up to approx. $\pm 10^\circ$ per link possible in longitudinal axis. This assists guiding the cables and lines around difficult geometries
- 2 High tensile strength thanks to special ball-and-socket principle, permits flexible movement along all axes at tested tensile forces of up to 2340 N (TRC 100.145.0)
- 3 Impact-resistant, dirt-repelling, rugged and abrasion-resistant, smooth, rounded exterior. Glides over interfering edges and protects cables by means of smooth internal and external contours. Tested over 1 million cycles at the igus® laboratory
- 4 Small bend radius & short pitch - Space-saving installation
- 5 Easy assembly and dismantling afforded by a single, die-cast component. No support elements (steel cables, spring suspensions etc.) are necessary along the tensile force vectors
- 6 High stability - Thanks to exterior stop dogs, defined stops for radius and torsion
- 7 Triflex® R-Set - compact module for all movements on robots, which can be fixed on existing fastening points
- 8 Easy attachment onto the robot/machine reduces setup time
- 9 For special cases furthermore available: Fibre rods, universal assembly kit and FlexBar



Order example of a complete E-Chain® - TRC.40

Indicate chain-lengths or number of links! Example: 2 m or 144 links

2,0 m **Series TRC.40.058.0**



E-Chain®

Mounting bracket with strain relief **TR40.01**



Mounting bracket

2 intermediate links without strain relief **TR40.02**



Mounting bracket

+ 600 mm fiber rods **TRC.F.40.0600.1.0**



Fiber rods



Series TRC - closed design - dirt-resistant

Series	Inner height		Outer width <i>Ba</i> [mm]	Bending radii <i>R</i> [mm]	max. ø cable		Weight [kg/m]
	<i>Bi 1</i>	<i>Bi 2</i>			<i>d1</i>	<i>d2</i>	
TRC.30.	050.0	12 10	34,5	050	10	8	≈ 0,27
TRC.40.	058.0	15 13	43	058	13	11	≈ 0,37
TRC.60.	087.0	22,5 19,5	65	087	20,5	17,5	≈ 0,85
TRC.70.	110.0	28 24	81	110	26	22	≈ 1,32
TRC.85.	135.0	33 28	94,5	135	31	26	≈ 1,75
TRC.100.	145.0	37,5 32,5	108	145	35,5	30,5	≈ 2,38
TRC.125.	182.0**	43,3 43,3	135	182	41	41**	≈ 4,70

** TRE.125/TRC.125 - max. cable diameter Ø 41 mm. Max. cable diameter changes to Ø 36 mm only.

if shortening/lengthening of a filled Triflex® R is required - TRE. 125: available upon request from autumn 2009

0 = standard color, other colors ▶ page 1.39

Part No.	Pitch [mm]	Links/m
TRC.30.	11,3	89
TRC.40.	13,9	72
TRC.60.	20,4	49
TRC.70.	25,6	39
TRC.85.	30,6	33
TRC.100.	34,5	29
TRC.125.**	44,6	23

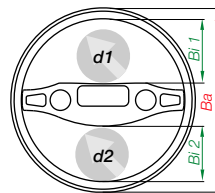
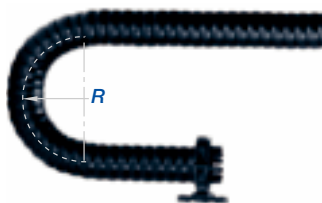

Part No. structure

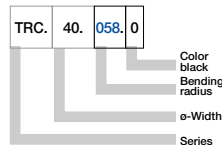

Series TRC - Dimensioning

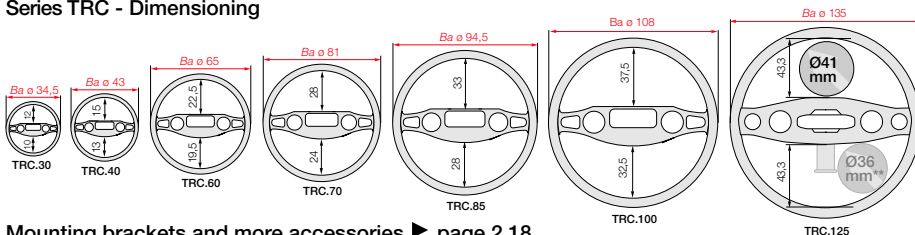

Mounting brackets and more accessories ▶ page 2.18

Material - permitted temperature °C

igumid NB / -40° up to +80° C

Flammability class, igumid NB

VDE 0304 IIC UL94 V2

Technical Data



Details of material properties

▶ page 1.38



Triflex® R - TRC
Inner height: 10-43,3 mm

Phone +49- (0) 22 03-96 49-800
Fax +49- (0) 22 03-96 49-222



▶ page 2.9



Price index



Cleanroom suitability upon request



UL94-V2 classification



Easy to fill - simply press cables in - "Easy-Principle"



When to use the Series TRE:

- When an easy to fill 3D-E-Chain® is needed
- If a secure cable guide is required for multi-dimensional 3D-movements
- If high torsional stability is required
- If the system has to be shortened or lengthened easily
- If a small bending radius is required
- If high tensile strength is important



When not to use it:

- For circular movements with high loads
 - ▶ System TwisterChain®, from page 2.56
- If a fully enclosed solution is required
 - ▶ Triflex® R - TRC, page 2.12
- If a more simple and cost effective solution is required
 - ▶ Triflex® R - TRL, page 2.16



- 1 Able to move multi-dimensionally - High degree of flexibility, even on the 6th axis. Twist up to approx. $\pm 10^\circ$ per link possible in longitudinal axis. This assists guiding the cables and lines around difficult geometries
- 2 High tensile strength thanks to special ball-and-socket principle, permits flexible movement along all axes
- 3 Easy opening mechanism for easy filling with cable and hose packages
- 4 Impact-resistant, dirt-repelling, rugged and abrasion-resistant, smooth, rounded exterior
- 5 Small bend radius & short pitch - Space-saving installation
- 6 Easy assembly and dismantling afforded by a single, die-cast component. No support elements (steel cables, spring suspensions etc.) are necessary along the tensile force vectors
- 7 High stability - Thanks to exterior stop dogs, defined stops for radius and torsion
- 8 Triflex® R-Set - compact module for all movements on robots, which can be fixed on existing fastening points
- 9 Easy attachment onto the robot/machine reduces setup time
- 10 For special cases furthermore available:
 - Fibre rods, universal assembly kit and FlexBar



Order example of a complete E-Chain® - TRE.40

Indicate chain-lengths or number of links! Example: 2 m or 144 Links

2,0 m Serie TRE.40.058.0



E-Chain®

1 set mounting bracket with strain relief TR40.01



Mounting bracket

2 intermediate links without strain relief TR40.02



Mounting bracket

+ 600 mm fiber rods TRC.F.40.0600.1.0



Fiber rods



"TRE" - "Easy" Design - simply press cables in

Series	Inner height		Outer width		Bending radii		max. ϕ cable		Weight [kg/m]
	Bi 1	Bi 2	Ba [mm]	R [mm]	d1*	d2*			
TRE.30.	050.0	12	10	34,5	050	10	8	≈ 0,26	
TRE.40.	058.0	15	13	43	058	13	11	≈ 0,36	
TRE.60.	087.0	22,5	19,5	65	087	20,5	17,5	≈ 0,83	
TRE.70.	110.0	28	24	81	110	26	22	≈ 1,30	
TRE.85.	135.0	33	28	94,5	135	31	26	≈ 1,67	
TRE.100.	145.0	37,5	32,5	108	145	35,5	30,5	≈ 2,35	
TRE.125.	182.0**	43,3	43,3	135	182	41	41**	≈ 4,40	

*For quick and easy insertion / removal of cables using the Easy Chain® principle, we recommend a maximum cable diameter of 70% of the specified value. ** TRE.125/TRC.125 - max. cable diameter ϕ 41 mm. Max. cable diameter changes to ϕ 36 mm only, if shortening/lengthening of a filled Triflex® R is required - available from autumn 2009

0 = standard color, other colors ▶ page 1.39

Part No.	Pitch [mm]	Links/m
TRC.30.	11,3	89
TRE.40.	13,9	72
TRE.60.	20,4	49
TRE.70.	25,6	39
TRE.85.	30,6	33
TRE.100.	34,5	29
TRE.125.**	44,6	23

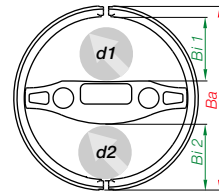
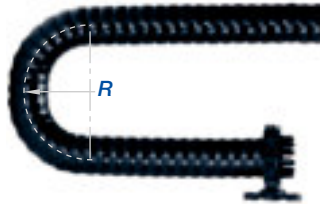

Triflex® R - TRE
Inner height: 10-43,3 mm

Part No. structure

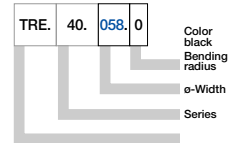

"TRE" - Dimensioning

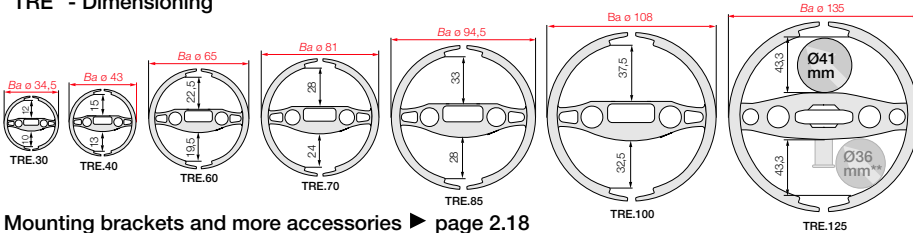

Mounting brackets and more accessories ▶ page 2.18

Material - permitted temperature °C igumid NB / -40° up to +80° C
Flammability class, igumid NB VDE 0304 IIC UL94 V2

Technical Data



Details of material properties
▶ page 1.38



▶ page 2.10



Cleanroom suitability upon request



iF-Design Award for "TRL"-Design



UL94-V2 classification



Easy to fill - simply press cables in - "Easy-Principle"



When to use the Series TRL:

- When an easy to fill, economical 3D-E-Chain® is needed
- When 3D-E-Chain® for easily manageable operating conditions is needed
- When a very easily operable 3D-E-Chain® is needed



When not to use it:

- For circular movements with high loads
 - ▶ System TwisterChain®, from page 2.56
- If a fully enclosed solution is required
 - ▶ Triflex® R - TRC page 2.12
- When a rugged, easy to fill variant is needed
 - ▶ Triflex® R - TRE page 2.14



- 1 Triflex® R light - save twice on purchasing and installation, single-piece element, easy to fill using Easy Chain® principle, matching Triflex® R standard mounting brackets
- 2 Able to move multi-dimensionally - High degree of flexibility, even on the 6th axis. Twist up to approx. $\pm 10^\circ$ per link possible in longitudinal axis. This assists guiding the cables and lines around difficult geometries
- 3 High tensile strength thanks to special ball-and-socket principle, permits flexible movement along all axes
- 4 Easy opening mechanism for easy filling with cable and hose packages
- 5 Small bend radius & short pitch - Space-saving installation
- 6 Easy assembly and dismantling afforded by a single, die-cast component. No support elements (steel cables, spring suspensions etc.) are necessary along the tensile force vectors. Easy shortening and lengthening afforded by a modular design.
- 7 Economical and light mounting bracket with strain relief or intermediate link



Order example of a complete E-Chain® - TRL.70

Indicate chain-lengths or number of links! Example: 2 m or 78 links

2,0 m Series TRL.70.110.0



E-Chain®

Mounting bracket with small strain relief TL.70.01.Z1



Mounting bracket



"TRL" - the light alternative with an "Easy" design

Series	Inner height	Outer width		Bending radii	max. ø cable		Weight
		Bi 1	Bi 2		Ba [mm]	d1*	
TRL.30. 050.0	12	10	34,5	050	10	8	≈ 0,15
TRL.40. 058.0	15	-	45	058	13	-	≈ 0,20
TRL.60. 087.0	23	-	65	087	20,5	-	≈ 0,40
TRL.70. 110.0	28	-	81	110	26	-	≈ 0,70
TRL.100.145.0	38	-	108	145	35,5	-	≈ 1,20

*For quick and easy insertion / removal of cables using the Easy Chain® principle, we recommend a maximum cable diameter of 70% of the specified value.

0 = standard color, other colors ▶ page 1.39

Part No.	Pitch [mm]	Links/m
TRL.30.	11,3	89
TRL.40.	13,9	72
TRL.60.	20,4	49
TRL.70.	25,6	39
TRL.100.	34,5	29

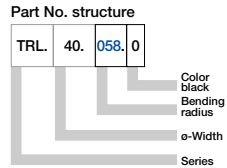
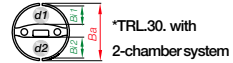
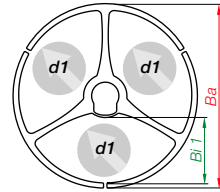

Triflex® R - TRL
Inner height: 12-38 mm

Phone +49- (0) 22 03-96 49-800
Fax +49- (0) 22 03-96 49-222

"TRL" - Dimensioning

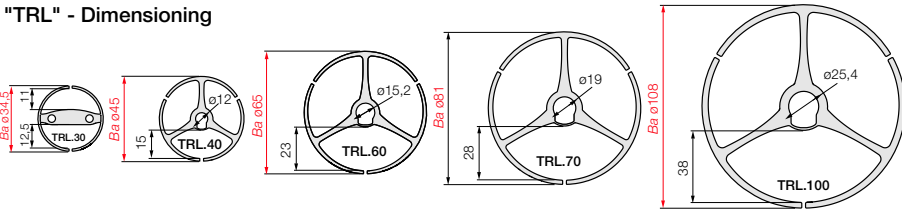

Mounting brackets and more accessories ▶ page 2.18

Material - permitted temperature °C	igumid NB / -40° up to +80° C
Flammability class, igumid NB	VDE 0304 IIC UL94 V2

Technical Data



Details of material properties
▶ page 1.38



▶ page 2.11



Option: Standard mounting brackets

- Quick and easy fixing
- Short downtimes when swapping a harnessed Triflex® R system
- Mounting bracket ① with strain relief available
- Mounting bracket also as ② intermediate link
- Quick assembly by means of spring locks
- Bracket holes for common robot types
- End and intermediate fixing possible

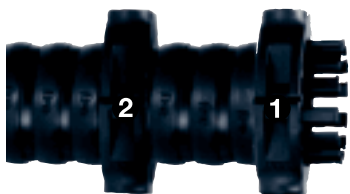

Dimensions and order configurations

Part No. structure

TR.60. 01. M6

- Option with insert nuts
- With strain relief
- Mounting bracket

Mounting bracket with strain relief TR.XX.01

Mounting bracket as intermediate link TR.XX.02

Mounting bracket without strain relief TR.XX.02

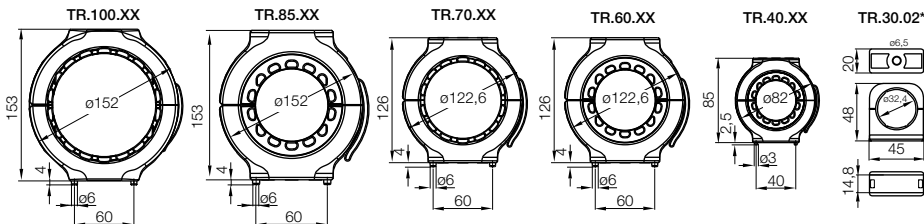
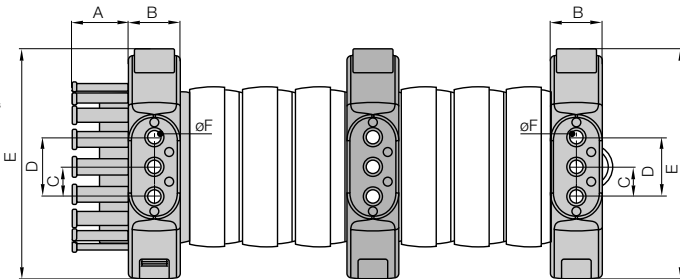

For Series	Mounting bracket with strain relief	Mounting bracket as intermediate link	Dim. A [mm]	Dim. B [mm]	Dim. C [mm]	Dim. D [mm]	Dim. E [mm]	Dim. ø F [mm]
TRC/TRE/TRL.30. ▶	-	TR.30.02	*	*	*	*	*	*
TRC/TRE/TRL.40. ▶	TR.40.01.M6	TR.40.02.M6	17,8	21	13,5	27	85	6,5
TRC/TRE/TRL.60. ▶	TR.60.01.M8	TR.60.02.M8	25	35	20	40	126	9
TRC/TRE/TRL.70. ▶	TR.70.01.M8	TR.70.02.M8	25	35	20	40	126	9
TRC/TRE.85. ▶	TR.85.01.M8	TR.85.02.M8	40	35	20	40	153	9
TRC/TRE/TRL.100. ▶	TR.100.01.M8	TR.100.02.M8	38	35	20	40	153	9

TRC/TRE.125 Dimensions and delivery time upon request!

* = dimensions in drawing

Strain relief is possible on the moving end and/or the fixed end.

Standard: Trough holes in ø F - Option: with insert nuts, steel, M6/M8

Phone +49- (0) 22 03-96 49-800
Fax +49- (0) 22 03-96 49-222

igus® GmbH
51147 Cologne

Internet: www.igus.eu
E-mail: info@igus.de



Option: Light mounting brackets

- Standard for TRL version, also compatible with all Triflex® R variants (TRC/TRE)
- Mounting bracket ① with strain relief available
- Mounting bracket also as ② intermediate link available
- Economical and light
- For simple 3D-movements and loads
- Comprising two halves - easy to assemble



Mounting bracket with strain relief TL.XX.01.Z2

Mounting bracket as intermediate link TL.XX.01.Z0

Mounting bracket without strain relief TL.XX.01.Z0

Dimensions and order configurations

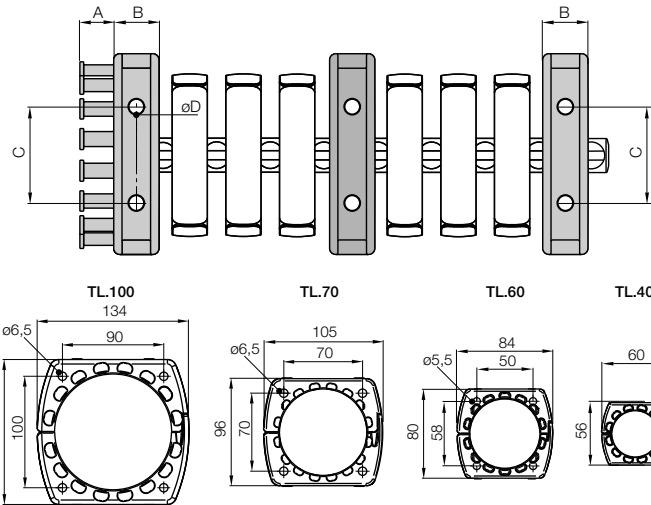

Part No. structure

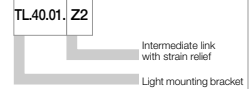

For Series	Part No.	Dim. A [mm]	Dim. B [mm]	Dim. C [mm]	Dim. ø D [mm]	For fixed end (socket)	For moving end (ball)	As intermediate link
TRC/TRE/TRL.30	▶ TL.30.01.Z0	○	13	24	4,5	TRC/TRE/TRL	TRC/TRE/TRL	TRC/TRE/TRL
	▶ TL.30.01.Z1	12,5	13	24	4,5	TRC/TRE/TRL	TRC/TRE/TRL	-
	▶ TL.30.01.Z2	20	13	24	4,5	TRC/TRE/TRL	TRC/TRE/TRL	-
TRC/TRE/TRL.40	▶ TL.40.01.Z0	○	14	36	5,8	TRC/TRE/TRL	TRC/TRE/TRL	TRC/TRE/TRL
	▶ TL.40.01.Z1	12,5	14	36	5,8	TRC/TRE/TRL	TRL	-
	▶ TL.40.01.Z2	20	14	36	5,8	TRC/TRE/TRL	TRC/TRE/TRL	-
TRC/TRE/TRL.60	▶ TL.60.01.Z0	○	20	48	5,8	TRC/TRE/TRL	TRC/TRE/TRL	TRC/TRE/TRL
	▶ TL.60.01.Z1	17	20	48	5,8	TRC/TRE/TRL	TRL	-
	▶ TL.60.01.Z2	27	20	48	5,8	TRC/TRE/TRL	TRC/TRE/TRL	-
TRC/TRE/TRL.70	▶ TL.70.01.Z0	○	27	64	6,5	TRC/TRE/TRL	TRC/TRE/TRL	TRC/TRE/TRL
	▶ TL.70.01.Z1	17,5	27	64	6,5	TRC/TRE/TRL	TRL	-
	▶ TL.70.01.Z2	27,5	27	64	6,5	TRC/TRE/TRL	TRC/TRE/TRL	-
TRC/TRE/TRL.100	▶ TL.100.01.Z0	○	30	64	6,5	TRC/TRE/TRL	TRC/TRE/TRL	TRC/TRE/TRL
	▶ TL.100.01.Z1	22,5	30	64	6,5	TRC/TRE/TRL	TRL	-
	▶ TL.100.01.Z2	42,5	30	64	6,5	TRC/TRE/TRL	TRC/TRE/TRL	-

○ = without strain relief - = not possible

Phone +49- (0) 22 03-96 49-800
Fax +49- (0) 22 03-96 49-222





Option: Swivel bearing - smooth motion

- To smoothen the motion of the cables requiring guidance, it is necessary to allow for extreme twisting and bending. This relieves cables with highly sensitive bending radii (such as optical fiber cables) when following a robot's movements. Swivel bearings are used to achieve this
- Available in 2 designs (with or without strain relief)
- Pivoted bearing with a maintenance-free igubal® ball-and-socket joint
- Minimization of critical bending cycles
- Gentler motion

Dimensions and order configurations

Part No. structure

TR.60.	03.	/ 04.
--------	-----	-------



TR.XX.04

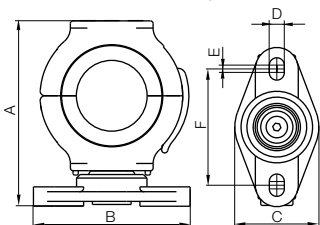

TR.XX.03

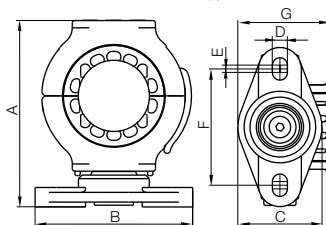

Phone +49- (0) 22 03-96 49-800
Fax +49- (0) 22 03-96 49-222



For Series	Standard	Swivel bearing with tiewrap plate	Swivel bearing as intermediate links	Dim.	Dim.	Dim.	Dim.	Dim.	Dim.	Dim.
				A	B	C	D	E	F	G*
TRC/TRE/TRL.40.	▶ TR.40.03	TR.40.04		105	89	47	8,4	4,1	65	51,8
TRC/TRE/TRL.60.	▶ TR.60.03	TR.60.04		152	118	65	10,5	5,5	87,5	73,5
TRC/TRE/TRL.70.	▶ TR.70.03	TR.70.04		152	118	65	10,5	5,5	87,5	73,5
TRC/TRE.85.	▶ TR.85.03	TR.85.04		179	118	65	10,5	5,5	87,5	88
TRC/TRE/TRL.100.	▶ TR.100.03	TR.100.04		179	118	65	10,5	5,5	87,5	88

*Only TR.XX.03

igus® GmbH
51147 Cologne

Strain relief systems (only for TRC/TRE) - Secure mounting of large cross sections with igus® standard Chainfix clamps

- Available in 3 options per size
- Multiaxially adjustable, for ideal positioning
- Suits all additional axles: Ø 30 mm, Ø 32 mm, Ø 34 mm

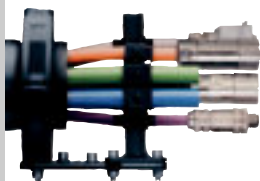

Product range clamps

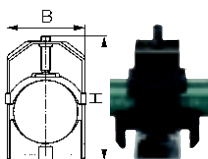

Part No. Steel	Part No. less Steel*	Stain-	ø	B	H
			[mm]	[mm]	[mm]
CFX12.1	CFX12.1.E	6 - 12	16	58	
CFX14.1	CFX14.1.E	12 - 14	18	50	
CFX16.1	CFX16.1.E	14 - 16	20	52	
CFX18.1	CFX18.1.E	16 - 18	22	54	
CFX20.1	CFX20.1.E	18 - 20	24	56	
CFX22.1	CFX22.1.E	20 - 22	26	58	

Part No. Steel	Part No. less Steel*	ø	B	H
		[mm]	[mm]	[mm]
CFX26.1	CFX26.1.E	22 - 26	30	67
CFX30.1	CFX30.1.E	26 - 30	34	71
CFX34.1	CFX34.1.E	30 - 34	38	75
CFX38.1	CFX38.1.E	34 - 38	42	79
CFX42.1	CFX42.1.E	38 - 42	46	83

*Material stainless steel: 1.4301

Internet: www.igus.eu
E-mail: info@igus.de

Triflex® R Quick exchange kit TR.60/70/85/100.22.XX

- Ideal for Triflex® R ReadyChain®
- One-time-only alignment
- No repeat alignment upon exchange of ReadyChain®
- Exchange of th Triflex® R unit incl. cables without any tools



For E-Chain®	Part No. Quick exchange kit
TRC/TRE.60 ▶	TR.60.22. 30 / 32 / 34
TRC/TRE.70 ▶	TR.70.22. 30 / 32 / 34
TRC/TRE.85 ▶	TR.85.22. 30 / 32 / 34
TRC/TRE.100 ▶	TR.100.22. 30 / 32 / 34

For required additional axes Ø 30, 32, 34 mm, please add appropriate Index e.g. TR.100.22 [.30](#)

Triflex® R pivot bracket TR.60/70/85/100.21.XX

- Available in 2 options per size (with/without strain relief)
- Safe and simple securing of the cables with cable ties
- Possible also without strain relief (Strain relief in the application)

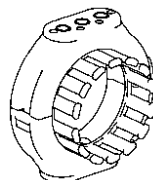

Pivot bracket with strain relief TR.XX21.01

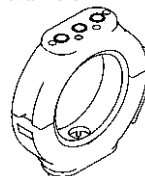

Pivot bracket with strain relief TR.XX21.02

For E-Chain®	Part No. Pivot bracket with strain relief	Part No. Pivot bracket without strain relief
TRC/TRE.60 ▶	TR.60.21.01. 30 / 32 / 34	TR.60.21.02. 30 / 32 / 34
TRC/TRE.70 ▶	TR.70.21.01. 30 / 32 / 34	TR.70.21.02. 30 / 32 / 34
TRC/TRE.85 ▶	TR.85.21.01. 30 / 32 / 34	TR.85.21.02. 30 / 32 / 34
TRC/TRE.100 ▶	TR.100.21.01. 30 / 32 / 34	TR.100.21.02. 30 / 32 / 34

For required additional axes Ø 30, 32, 34 mm, please add appropriate Index e.g. TR.100.21.01 [.30](#)

Triflex® R connection TR.70/85/100.20.XX

- In the use of cables with large cross section, e.g. welding applications or in heavy hydraulic hoses
- Double C rails for igus® CFX clips
- Rugged strain relief in "heavy-duty" applications
- igus® Chainfix clamps made of stainless steel or steel can be used (see Table on the right)

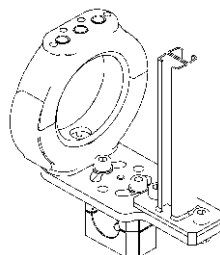

For E-Chain®	Part No. Connection
TRC/TRE.60 ▶	TR.60.20. 30 / 32 / 34
TRC/TRE.70 ▶	TR.70.20. 30 / 32 / 34
TRC/TRE.85 ▶	TR.85.20. 30 / 32 / 34
TRC/TRE.100 ▶	TR.100.20. 30 / 32 / 34

For required additional axes Ø 30, 32, 34 mm, please add appropriate Index e.g. TR.100.20 [.30](#)

Triflex® R

Phone +49- (0) 22 03-96 49-800
Fax +49- (0) 22 03-96 49-222



▶ page 2.9-11

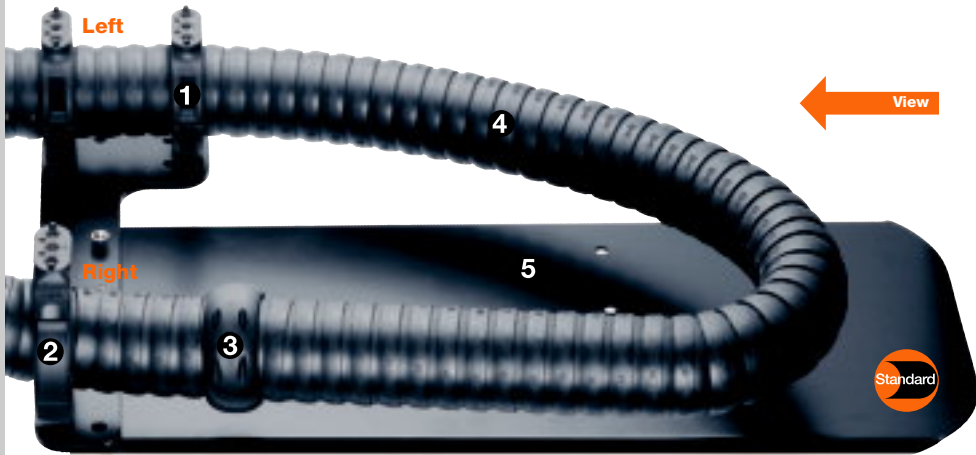

Triflex® RS - Extremely flat design,
guides close to the robotic arm



Integrated recuperating spring
prevents loop formations

Universal module for any robotic motion

Triflex® RS is a very compact universal module that can be attached to the fastening points on the robot. Applications in very limited space can be realized, thanks to the small installation height and to the fact that Triflex® RS can be installed parallel to the robotic arm. Triflex® RS with integrated spring mechanism allows efficient energy supply to the robotic head, without stress on the cables. The Triflex® R kit offers all advantages of proven Triflex® accessories, such as the FlexBar, universal assembly kit and fiber rod module in one system. All Triflex® R features are also included in the universal Triflex® RS module.

- **Standard-package** for all applications for immediate installation
- **Integrated spring mechanism**
- **The first choice** for robotic applications with limited space
- **Saves space** - small installation height and closely routed on the robotic arm
- **Outstanding service life**
- **Universal installation**

- ① Mounting brackets for safe fastening
- ② Glide lead-through for a close and parallel guidance on the robotic arm
- ③ Limit stop dog for a defined free movement
- ④ Integrated recuperating spring prevents loop formations
- ⑤ Single module, space-saving and quickly mounted on robot

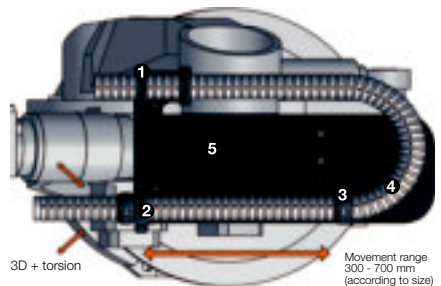

Triflex® RS - Installation Dimensions

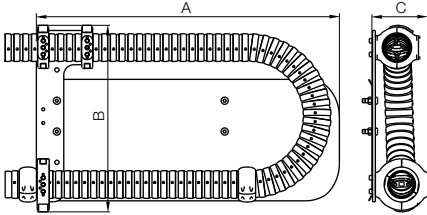

Triflex® RS - Fastening point, right

Universal module	Part No.	A	B	C
TRS for Series		[mm]	[mm]	[mm]
TRC.40/TRE.40	▶ TRC/TRE.RS.40.R	620	301	95
TRC.60/TRE.60	▶ TRC/TRE.RS.60.R	885	528	150
TRC.70/TRE.70	▶ TRC/TRE.RS.70.R	885	545	167
TRC.85/TRE.85	▶ TRC/TRE.RS.85.R	885	565	167
TRC.100/TRE.100	▶ TRC/TRE.RS.100.R	912,5	614	167

Triflex® RS - Fastening point, right, with cover

Universal module	Part No.	A	B	C
TRS for Series		[mm]	[mm]	[mm]
TRC.40/TRE.40	▶ TRC/TRE.RS.40.RC	620	301	95
TRC.60/TRE.60	▶ TRC/TRE.RS.60.RC	885	528	150
TRC.70/TRE.70	▶ TRC/TRE.RS.70.RC	885	545	167
TRC.85/TRE.85	▶ TRC/TRE.RS.85.RC	885	565	167
TRC.100/TRE.100	▶ TRC/TRE.RS.100.RC	912,5	614	167

Triflex® RS - Fastening point, left

Universal module	Part No.	A	B	C
TRS for Series		[mm]	[mm]	[mm]
TRC.40/TRE.40	▶ TRC/TRE.RS.40.L	620	301	95
TRC.60/TRE.60	▶ TRC/TRE.RS.60.L	885	528	150
TRC.70/TRE.70	▶ TRC/TRE.RS.70.L	885	545	167
TRC.85/TRE.85	▶ TRC/TRE.RS.85.L	885	565	167
TRC.100/TRE.100	▶ TRC/TRE.RS.100.L	912,5	614	167

Triflex® RS - Fastening point, left, with cover

Universal module	Part No.	A	B	C
TRS for Series		[mm]	[mm]	[mm]
TRC.40/TRE.40	▶ TRC/TRE.RS.40.LC	620	301	95
TRC.60/TRE.60	▶ TRC/TRE.RS.60.LC	885	528	150
TRC.70/TRE.70	▶ TRC/TRE.RS.70.LC	885	545	167
TRC.85/TRE.85	▶ TRC/TRE.RS.85.LC	885	565	167
TRC.100/TRE.100	▶ TRC/TRE.RS.100.LC	912,5	614	167

Fastening point, right



Triflex® R-Set with cover for the additional support of switch cabinets or valve terminals

Triflex® R - More accessories available now ...



Triflex® R-Set with cover (barrier)

- Creates more mounting space on robots - e.g. for switch cabinets or valve terminals
- For upside down applications
- Enables the use of Triflex® RS in applications with extreme movements

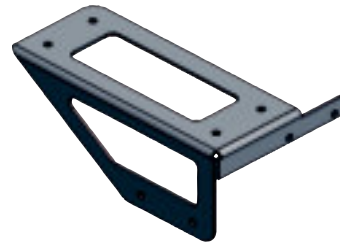

43 Adapter brackets for robots from stock

- 43 adapter bracket types from stock for many different robots
- For all Triflex® RS modules
- For assembly to the side or on top
- Free download of 3D CAD files for many brackets ▶ www.igus.eu/triflexbrackets

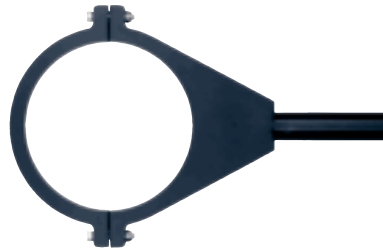

Triflex® R fixation to axis 6
Part No. TR.907.667.Inner 6

- One axis diameter (Ø30 mm) for all robots
- Easy and fast assembly
- For Triflex® R mounting bracket with CFX clamps (TR.XX.20.30)
- Für Triflex® R mounting bracket with tiewrap plates (TR.XX21.30)
- For TR.XX.22.30 Quick exchange kit

Triflex® R

Phone +49- (0) 22 03-96 49-800
Fax +49- (0) 22 03-96 49-222



▶ page 2.9-11

igus® E-ChainSystems®

Phone +49- (0) 22 03-96 49-800
Fax +49- (0) 22 03-96 49-222

igus® GmbH
51147 Cologne

Internet: www.igus.eu
E-mail: info@igus.de

Other accessories available for special applications...



Fiber rod modules - Intelligent problem solution through directed pretension (for TRC/TRE)

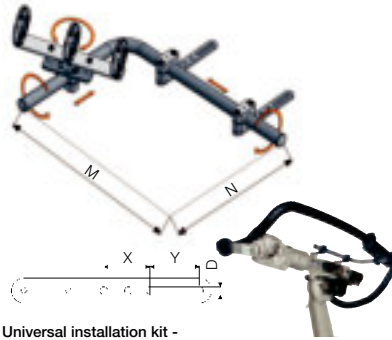

Universal installation kit - Easy engineering of the fiber rods (for TRC/TRE)

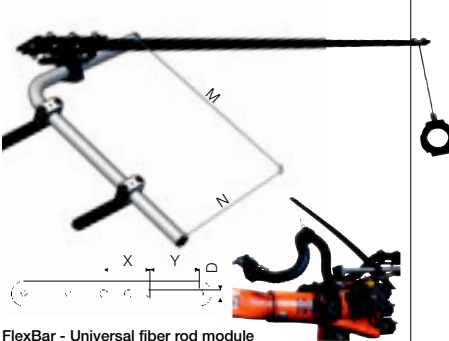

FlexBar - Universal fiber rod module for extreme robotic movements (for TRC/TRE)

The igus® universal module as standard Triflex® R-Set ▶ page 2.22

Fiber rod module, universal assembly kit and FlexBar as individual parts for Triflex® R

Fiber rod module: For applications where too much flexibility is not desired. **Universal installation kit:** Universal installation kit allows the attachment of fiber rod modules in any given position, relative to the robotic arm. **FlexBar:** For robot-applications with extreme movements in the 4th to 6th axis and avoidance from loops

Product range - Fiber rods

Part No. TRC/TRE with mounted fiber rods		Length ca. [m]	max. load [kg/m]
Triflex® R 40	TRC.F.40.1000.1.0/TRE.F.40.1000.1.0	1,0	0,4
	TRC.F.40.0900.1.0/TRE.F.40.0900.1.0	0,9	0,5
	TRC.F.40.0800.1.0/TRE.F.40.0800.1.0*	0,8	0,6
	TRC.F.40.0700.1.0/TRE.F.40.0700.1.0	0,7	0,7
	TRC.F.40.0600.1.0/TRE.F.40.0600.1.0	0,6	0,8
Triflex® R 60	TRC.F.40.0500.1.0/TRE.F.40.0500.1.0	0,5	0,9
	TRC.F.40.0400.1.0/TRE.F.40.0400.1.0	0,4	1,0
	TRC.F.60.1400.1.0/TRE.F.60.1400.1.0	1,4	1,0
	TRC.F.60.1200.1.0/TRE.F.60.1200.1.0	1,2	1,2
Triflex® R 70	TRC.F.60.1000.1.0/TRE.F.60.1000.1.0*	1,0	1,4
	TRC.F.60.0800.1.0/TRE.F.60.0800.1.0	0,8	1,6
	TRC.F.60.0600.1.0/TRE.F.60.0600.1.0	0,6	1,8
	TRC.F.60.0400.1.0/TRE.F.60.0400.1.0	0,4	2,0
Triflex® R 85	TRC.F.70.1800.1.0/TRE.F.70.1800.1.0	1,8	1,4
	TRC.F.70.1600.1.0/TRE.F.70.1600.1.0	1,6	1,6
	TRC.F.70.1400.1.0/TRE.F.70.1400.1.0	1,4	1,8
	TRC.F.70.1200.1.0/TRE.F.70.1200.1.0*	1,2	2
Triflex® R 100	TRC.F.70.1000.1.0/TRE.F.70.1000.1.0	1,0	2,2
	TRC.F.70.0800.1.0/TRE.F.70.0800.1.0	0,8	2,4
	TRC.F.85.2000.1.0/TRE.F.85.2000.1.0	2,0	1,4
	TRC.F.85.1800.1.0/TRE.F.85.1800.1.0	1,8	1,7
Triflex® R 85	TRC.F.85.1600.1.0/TRE.F.85.1600.1.0	1,6	1,9
	TRC.F.85.1400.1.0/TRE.F.85.1400.1.0*	1,4	2,1
	TRC.F.85.1200.1.0/TRE.F.85.1200.1.0	1,2	2,3
	TRC.F.85.1000.1.0/TRE.F.85.1000.1.0	1,0	2,6
Triflex® R 100	TRC.F.85.0800.1.0/TRE.F.85.0800.1.0	0,8	3,0
	TRC.F.100.2000.1.0/TRE.F.100.2000.1.0	2,0	1,6
	TRC.F.100.1800.1.0/TRE.F.100.1800.1.0	1,8	2,0
	TRC.F.100.1400.1.0/TRE.F.100.1400.1.0*	1,4	2,4
Triflex® R 100	TRC.F.100.1200.1.0/TRE.F.100.1200.1.0	1,2	2,6
	TRC.F.100.1000.1.0/TRE.F.100.1000.1.0	1,0	3,0

*recommended lengths of the fiber rods

Product range - Universal installation kit

Installation kit for Series	Part No.	X [mm]	Y [mm]	M [mm]	N [mm]	D [mm]
TRC/TRE.40	▶ TR.40.80	40	30	475	325	6,3
TRC/TRE.60	▶ TR.60.80	40	30	475	325	6,3
TRC/TRE.70	▶ TR.70.80	75	80	875	575	12,5
TRC/TRE.85	▶ TR.85.80	75	80	875	575	12,5
TRC/TRE.100	▶ TR.100.80	75	80	875	575	12,5

Product range - FlexBar

FlexBar for Series	Part No.	X [mm]	Y [mm]	M [mm]	N [mm]	D [mm]
TRC/TRE.60	▶ TR.60.90	40	30	475	325	6,3
TRC/TRE.70	▶ TR.70.90	75	80	875	575	12,5
TRC/TRE.85	▶ TR.85.90	75	80	875	575	12,5
TRC/TRE.100	▶ TR.100.90	75	80	875	575	12,5

Triflex® R protectors - high safety under extreme operating conditions

- To achieve long life cycles under heavy loads resulting from impact or friction on the robot's E-Chains®, optional protectors can be fitted at the contact points
- Easy assembly and quick replacement
- Abrasion-resistant TPU material
- Absorptive
- Light
- Easy gliding over edges
- Free positioning on any chain link

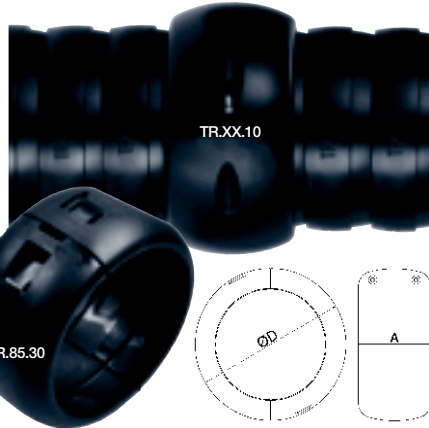

For Series	Part No. protectors	Ø D [mm]	A [mm]
TRC/TRE.40	▶ TR.40.10	53	27
TRC/TRE.60	▶ TR.60.10	77	40
TRC/TRE.70	▶ TR.70.10	100	50
TRC/TRE.85	▶ TR.85.10 TR.85.30	118	59
TRC/TRE.100	▶ TR.100.10	133	67

Triflex® R

Triflex® R cover: Heat shield - TR.XX.15

- Protection against weld spatter and metal splashes at temp. of up to 600°C (short-term)
- Base support: Fabric
- Coating: Aramid
- Easy to replace via longitudinally positioned velcro fastenings
- Elastic sealing strips
- Asbest-free
- Standard lengths available ex stock

For Series	TR.XX.15 Part No.	Standard lengths [mm]
	[YY] = Jacket length	
TRC/TRE/TRL.40	▶ TR.40.15. [YY]	500 1000 1500 2000
TRC/TRE/TRL.60	▶ TR.60.15. [YY]	500 1000 1500 2000
TRC/TRE/TRL.70	▶ TR.70.15. [YY]	500 1000 1500 2000
TRC/TRE.85	▶ TR.85.15. [YY]	500 1000 1500 2000
TRC/TRE/TRL.100	▶ TR.100.15. [YY]	500 1000 1500 2000



Standard protective jacket - TR.XX.16

- Temperature up to room temp.
- Base support: Fabric
- Coating: None
- Easy to replace via longitudinally positioned velcro fastenings
- Elastic sealing strips
- Silicon-free
- Standard lengths available ex stock

For Series	TR.XX.16 Part No.	Standard lengths [mm]
	[YY] = Jacket length	
TRC/TRE/TRL.40	▶ TR.40.16. [YY]	500 1000 1500 2000
TRC/TRE/TRL.60	▶ TR.60.16. [YY]	500 1000 1500 2000
TRC/TRE/TRL.70	▶ TR.70.16. [YY]	500 1000 1500 2000
TRC/TRE.85	▶ TR.85.16. [YY]	500 1000 1500 2000
TRC/TRE/TRL.100	▶ TR.100.16. [YY]	500 1000 1500 2000

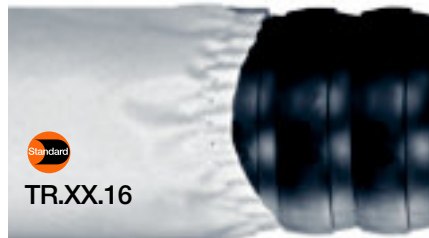

Light protective jacket - TR.XX.17

- Temperature up to room temp.
- Base support: Fabric (spunbonded web)
- Coating: None
- Easy to replace via longitudinally positioned velcro fastenings
- Elastic sealing strips
- Silicon-free
- Standard lengths available ex stock

For Series	TR.XX.17 Part No.	Standard lengths [mm]
	[YY] = Jacket length	
TRC/TRE/TRL.40	▶ TR.40.17. [YY]	500 1000 1500 2000
TRC/TRE/TRL.60	▶ TR.60.17. [YY]	500 1000 1500 2000
TRC/TRE/TRL.70	▶ TR.70.17. [YY]	500 1000 1500 2000
TRC/TRE.85	▶ TR.85.17. [YY]	500 1000 1500 2000
TRC/TRE/TRL.100	▶ TR.100.17. [YY]	500 1000 1500 2000



Phone +49- (0) 22 03-96 49-800
Fax +49- (0) 22 03-96 49-222



Determining the cable area



Mounting bracket TR.70.01 - Strain relief for electric cables



We would be glad to help you in the selection of the right size with our Triflex® R project planning software

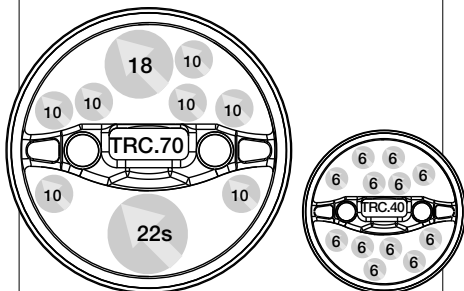

Examples of filling TRC.70 and TRC.40

Choice of the right chain length

Filling and correct sizing - Clearance for cables and hoses is important when filling Triflex® R, in order to compensate for friction forces due to relative movement between E-Chain® and filling. The following serves as a rule of thumb: The total of all cable/hose diameters must not exceed 60% of the available cross section. A clearance of min. 10% (min. 1mm) needs to be maintained towards the next cable and the Triflex® R. Please see the attached chart for available cross sections. igus® will be glad to run such calculations for you.

For Series	Effective areas [mm ²]	For Series	Effective areas [mm ²]
TRC/TRE.30	313	TRL.30	313
TRC/TRE.40	508	TRL.40	670
TRC/TRE.60	1144	TRL.60	1499
TRC/TRE.70	1788	TRL.70	1242
TRC/TRE.85	2431	-	-
TRC/TRE.100	3176	TRL.100	4125
TRC/TRE.125	4584	-	-

Example of determining cable area

$$A_{\text{Leitung}} = \frac{d^2 \times \pi}{4}$$

Examples :

$$\begin{aligned} A_1 &= (10 \text{ mm} \times 10 \text{ mm} \times \pi) / 4 \\ &= 78,5 \text{ mm}^2 \times 7 \text{ (number of cables)} \\ &= 549,50 \text{ mm}^2 \end{aligned}$$

$$\begin{aligned} A_2 &= (18 \text{ mm} \times 18 \text{ mm} \times \pi) / 4 \\ &= 254,34 \text{ mm}^2 \end{aligned}$$

$$\begin{aligned} A_3 &= (22 \text{ mm} \times 22 \text{ mm} \times \pi) / 4 \\ &= 379,94 \text{ mm}^2 \end{aligned}$$

$$A_{\text{Leitung}} = A_1 + A_2 + A_3 = 1183,7 \text{ mm}^2$$

The smaller the ratio between the effective area and the sum of the cable areas, the lower the load on the cables

Customer-specific special cable for robotic and torsion applications

- Control, motor, servo, bus and data cables
- Shielded and unshielded
- Outer jacket material: PVC, PUR, TPE
- Special cables from 500 m
- Torsion area according to requirement
- Sectors: Robotic and 3D applications

The service life of cables in torsion applications depend disproportionately on the exact progression of the angle of torsion and the cable length of the exact application. As a single test facility is often insufficient, Chainflex® cables are tested on various constructional systems. Your torsion cables are tested as realistic as possible for your application. For this purpose, igus® uses up to 8 different test facilities in the in-house laboratory.

Torsionable Chainflex® robotic cables for +/-180° angle of twist per meter length

More information ► www.igus.de/chainflexnews



Chainflex® CFROBOT9 - PUR-Hybrid cable, torsionable



Chainflex® CFROBOT8 - PUR-Bus cable, torsionable



Chainflex® CFROBOT6 - PUR-Motor cable, torsionable



Chainflex® CFROBOT7 - PUR-Motor cable, torsionable, shielded



Chainflex® CFROBOT5 - TPE-Fiber optic cable, torsionable



Chainflex® CFROBOT - Single-core TPE robotic cable

Triflex® R - ReadyChain® cable packages for robots

High component holding times and low downtimes are of the highest priority in manufacturing plants. With a Triflex® R ReadyChain we design and develop a customized ReadyChain® system for you, consisting of the "construction kits" Triflex® R, Chainflex® and igus® connectors. An installation can of course be executed by our Triflex® R installation engineers on your site.

Your advantages:

- Reduces your storage costs to zero for cables, E-Chain® and connectors
- Cuts your running time by half
- Responds flexibly to order variations
- Minimize machine downtimes
- Reduce the number of suppliers and orders by 75%

Triflex® R - Tests in the igus® lab



Testing facility at the igus® laboratory



Torsion test of CF-ROBOT

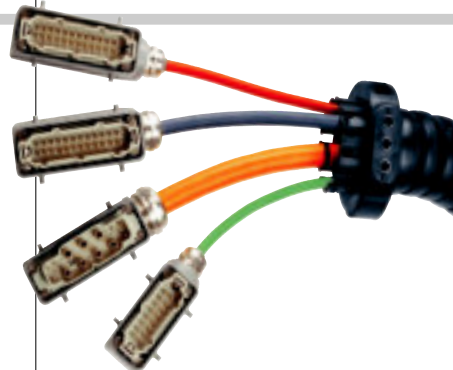

Ready-made packages in 3 to 10 days



igus® E-ChainSystems®

Phone +49- (0) 22 03-96 49-800
Fax +49- (0) 22 03-96 49-222

igus® GmbH
51147 Cologne

Internet: www.igus.eu
E-mail: info@igus.de



On-location assembly by the igus® specialist team

We maximize your robot application's service life

Robot applications are very diverse and sometimes extremely complex in terms of configuration. To maximize your robot application's service life with Triflex® R, igus® has a specially trained, robotics planning and installation team which can install Triflex® R E-Chains® into your applications. Minimize your planning effort by delegating as many tasks as possible to us. Our trained staff offer support toward smooth project implementation every step of the way - whether you simply want to consult our assembly team or have an entire system of machines planned and installed. By telephone we can always provide answers to a host of questions and point out all the advantages of Triflex® R for your company. On site, we can acquire all the data necessary for preparing detailed planning documents. From project planning through customized quotations right up to expert installation of the Triflex® R on your site, we remain at your service round the clock.

Global Warranty Certificate

Global warranty for _____

This certificate is the warranty document for the gear 1 (Customer's) application described in the next section of this certificate.

This certificate is valid for the application described in the next section of this certificate. The certificate is valid for the application described in the next section of this certificate. The certificate is valid for the application described in the next section of this certificate.

For further information, please contact our Customer Support at the following address:

Our address:

- We also offer guarantee certificates for complete systems
- No minimum order quantities, no surcharges
- 1500 staff in Germany and at 26 international subsidiaries and offices. Stations in over 30 other countries

Your advantage

- We are wherever you need us
- Your service requirements are fulfilled quickly by experts on location
- Guaranteed, fast worldwide delivery
- Spare parts are available from stock at short notice
- Order tracking via igus® "i-net" - www.igus.de/en/i-net

igus® system warranty - igus® warranty certificates will be issued for your application individually. "chain, cable, warranty"



Projection with well-designed forms and special software

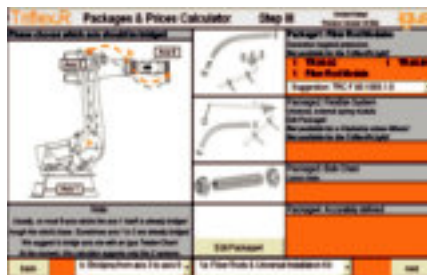

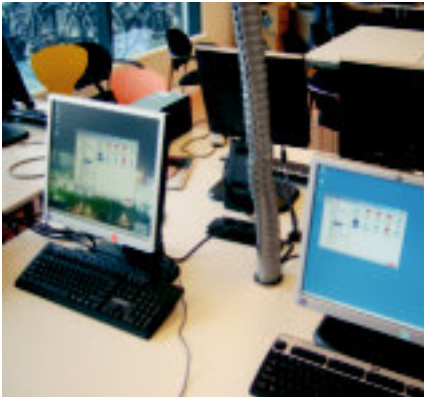

iF-award-winning Triflex® R TRE for a safe energy supply also in office equipment



Cable management in a TV studio with Triflex® R



igus® System E6 and Triflex® R TRE in a Y/Z-gantry



Torsion testing of Triflex® R in the igus® laboratory, Cologne



igus® E2 E-Tube and Triflex® R in a processing machine



Optimal cable guidance even under extreme conditions, such as here in the Jungmeier roof tile plant

Triflex® R

Phone +49- (0) 22 03-96 49-800

Fax +49- (0) 22 03-96 49-222



Easy Triflex®



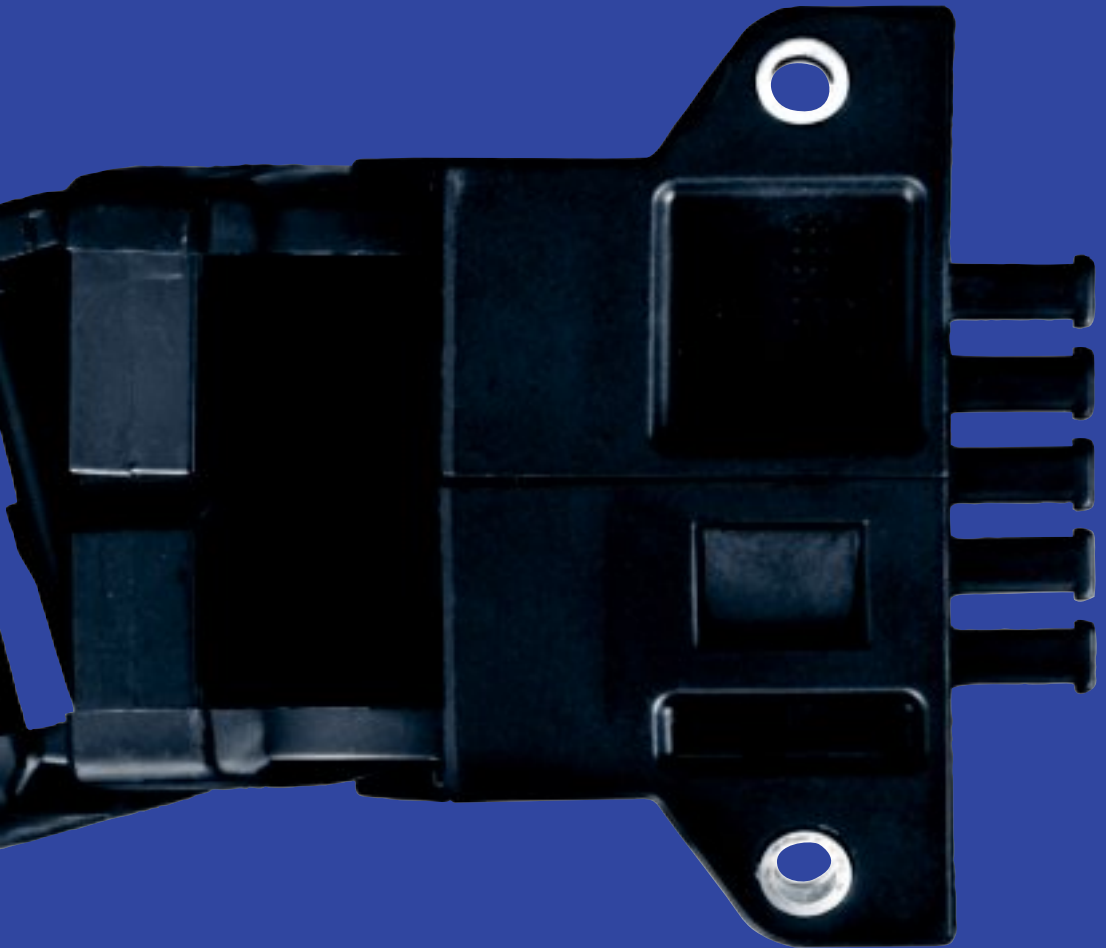

Easy Triflex® - E-Chain® for simple 3D-applications

The Triflex® Series was developed to realize safe energy supply in the case of multi-dimensional movements. In doing so the flexibility of a hose was combined with the stability of an E-Chain® and its defined radii. With the Easy Triflex® the installation of cables, wires and hoses has also become child's play. In case of flexible crossbars the cables are now simply pushed into the E-Chain® from above or below. The unique modular program allows you to follow very complex movements. For Example: Combine 1-axis, 2-axis and 3-axis movement links in one E-Chain®.

Typical industries and applications

- Machine tools
- Robots
- Handling equipment
- Material handling
- Plastics machinery
- Construction machines
- Vehicles
- Machinery of all kinds
- Medical equipment
- Semicon office furniture



iF-Design awards for
Easy Triflex®-design



Torsional motion
possible



UL94-V2
classifications



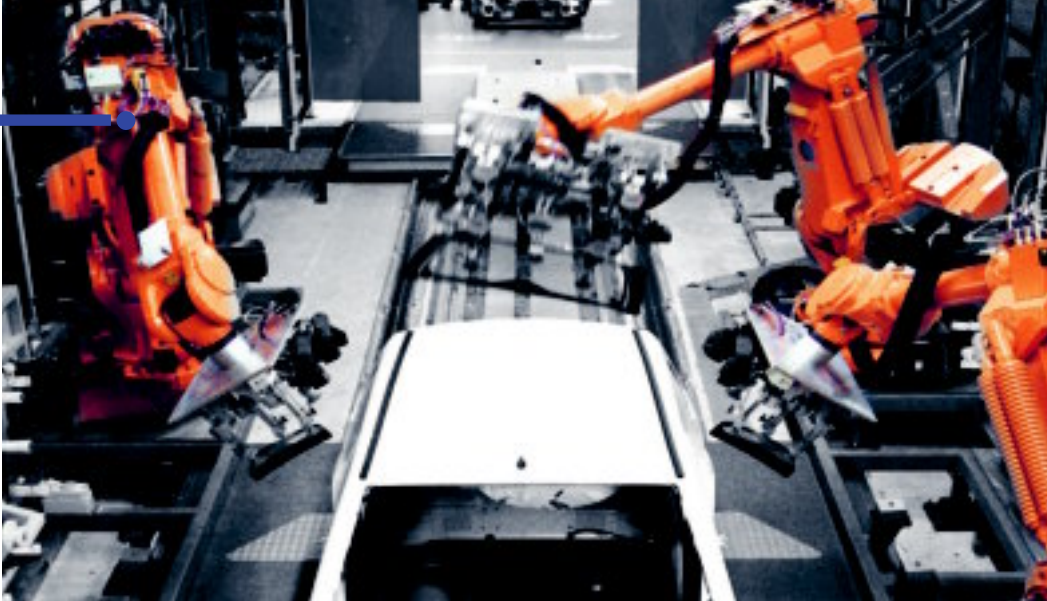

Robots with igus® Easy Triflex® E-Chains® on an assembly line



Easy Triflex® E-Chains® for multi-dimensional movements on a production line



Easy Triflex® E-Chains® also for easy applications - here an aesthetic application

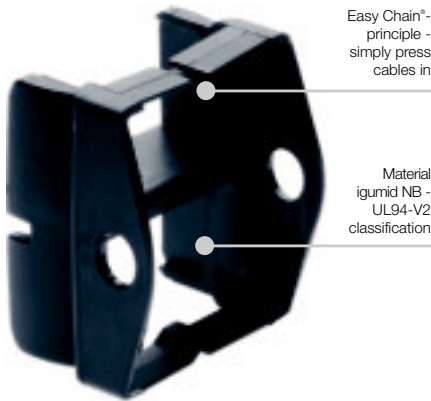

Easy Chain®-
principle -
simply press
cables in

Material
igumid NB -
UL94-V2
classification

Select this modular E-ChainSystem® for:

- 3-axis motions in all kinds of machinery
- Some robotics applications
- Very fast cable assembly with "Easy" principle
- Simple filling from two sides
- Where rectangular shapes fit better
- Combination of different bending radii and movement directions
- Lengthen and shorten anywhere
- KMA mounting brackets with integrated strain relief
- You can find more technical data about the material, chemical resistance, temperatures ► [chapter design, from page 1.38](#)

Selection table

Series	Inner height <i>Bi 1/Bi 2</i> [mm]	Inner width <i>Bi 3</i> [mm]	Outer width/Outer height <i>Ba</i> [mm]	Bending radii <i>R</i> [mm]	Page
Single-axis and double-axis movement					
E332.25	13	25	34	048 - 200	2.36
E332.32	17	32	50	075 - 250	2.36
E332.50	26	50	68	100 - 250	2.36
E332.75	38,5	75	96	140 - 300	2.36

Triple-axis movement

E333.25	13	25	34	048 - 200	2.36
E333.32	17	32	50	075 - 250	2.36
E333.50	26	50	68	100 - 250	2.36
E333.75	38,5	75	96	140 - 300	2.36

Assembling | Easy Triflex®



Twist and snap in



Shorten and lengthen at any given point

Separating | Easy Triflex®

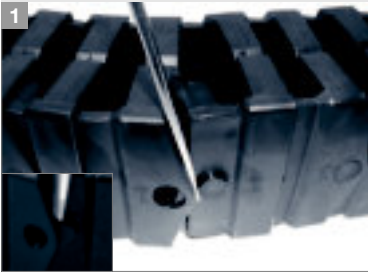

Lever the Easy Triflex® side link with screwdriver



Twist and separate - For Series E333 you have to separate the "middle" pin

Filling | Easy Triflex®



Easy to fill - simply press cables in...



...and easy to take the cables out





Price index

UL94-V2
classificationTorsional
motion possibleiF-Design awards for
Easy Triflex® designEasy to fill - simply press cables in
and easy to take the cables out**When to use the Series E332/E333:**

- If simple filling with complex movements is required
- If simple filling from both sides with complex movements is required
- For repair and supplementation of existing Triflex® Systems

**When not to use them:**

- If complex robotics applications are required
 - ▶ Triflex® R - TRE, from page 2.14
- For circular movements with high loads
 - ▶ System TwisterChain®, from page 2.56
- If chip protection is necessary
 - ▶ System Triflex®, from page 2.42



- 1 KMA split-open mounting bracket with integrated strain relief
- 2 Patented "push-button-principle"
- 3 Shorten and lengthen at any given point
- 4 Different bending radii and directions can be combined
- 5 Simple filling from 2 sides "Easy Chain"-principle - simply press in cable along the inner radius or the outer radius
- 6 3-Axis motions in machinery of all kinds
- 7 Robotics applications possible
- 8 iF-Design Award Winner

**Order example of a complete E-Chain®**

Indicate chain-lengths or number of links! Example: 2 m or 68 links

2,0 m E333.50.100/100.0



E-Chain®

1 set 333.50.12PZ



Mounting bracket



Series E332.25.2 - single/double-axis movement

R	048	075	100	125	150	175	200
H	130	185	235	285	335	385	435
D	095	125	150	175	200	225	250
K	195	280	360	440	515	595	675

Series E332.32.2 - single/double-axis movement

R	075	100	125	150	200	250
H	200	250	300	350	450	550
D	130	155	180	205	255	305
K	305	385	465	545	700	865

Series E332.50.2 - single/double-axis movement

R	100	125	150	200	250
H	270	320	375	470	570
D	195	220	245	295	345
K	435	520	590	750	910

Series E332.75.2 - single/double-axis movement

R	140	175	200	250	300
H	380	450	500	600	700
D	240	275	300	350	400
K	550	660	740	900	1060

Series E333.25 - triple-axis movement

R	048	075	100	125	150	175	200
H	230	335	435	535	635	735	835
D	145	200	250	300	350	400	450
K	350	515	675	830	990	1150	1300

Series E333.32 - triple-axis movement

R	075	100	125	150	200	250
H	350	450	550	650	850	1050
D	205	255	305	355	455	555
K	545	700	860	1020	1300	1605

Series E333.50 - triple-axis movement

R	100	125	150	200	250
H	470	570	670	870	1070
D	295	345	395	495	595
K	750	910	1070	1380	1690

Series E333.75 - triple-axis movement

R	140	175	200	250	300
H	660	800	900	1100	1300
D	380	450	500	600	700
K	990	1210	1400	1700	2000

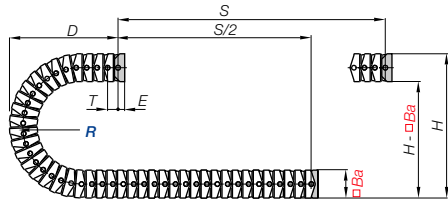

Series E332.25.2.

Pitch $T = 14,5$ mm/link
 Links/m = 69 (1000,5 mm)
 Dim. $E = 10$ mm
 $Ba = 34$ mm
 Chain length = $S/2 + K$

Series E332.32.2.

Pitch $T = 25$ mm/link
 Links/m = 40 (1000 mm)
 Dim. $E = 20$ mm
 $Ba = 50$ mm
 Chain length = $S/2 + K$

Series E332.50.2.

Pitch $T = 30$ mm/link
 Links/m = 34 (1020 mm)
 Dim. $E = 25$ mm
 $Ba = 68$ mm
 Chain length = $S/2 + K$

Series E332.75.2.

Pitch $T = 36$ mm/link
 Links/m = 28 (1008 mm)
 Dim. $E = 25$ mm
 $Ba = 96$ mm
 Chain length = $S/2 + K$

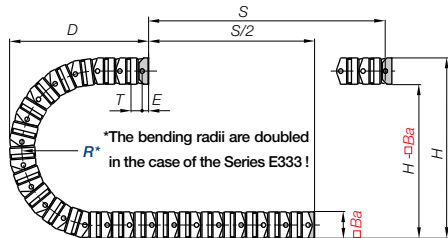

Series E333.25.

Pitch $T = 14,5$ mm/link
 Links/m = 69 (1000,5 mm)
 Dim. $E = 10$ mm
 $Ba = 34$ mm
 Chain length = $S/2 + K$

Series E333.32.

Pitch $T = 25$ mm/link
 Links/m = 40 (1000 mm)
 Dim. $E = 20$ mm
 $Ba = 50$ mm
 Chain length = $S/2 + K$

Series E333.50.

Pitch = 30 mm/link
 Links/m = 34 (1020 mm)
 Dim. $E = 25$ mm
 $Ba = 68$ mm
 Chain length = $S/2 + K$

Series E333.75.

Pitch = 36 mm/link
 Links/m = 28 (1008 mm)
 Dim. $E = 25$ mm
 $Ba = 96$ mm
 Chain length = $S/2 + K$

Technical Data



Details of material properties
 ► page 1.38

Material - permitted temperature °C igumid NB / -40° up to +80° C
 Flammability class, igumid BNB VDE 0304 IIC UL94 V2



Easy Triflex®

Phone +49- (0) 22 03-96 49-800
 Fax +49- (0) 22 03-96 49-222



► page 2.35

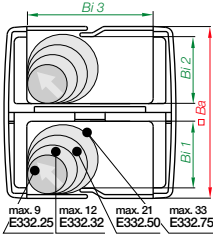

Single-axis movement - Series E332

Part No.	Bi1/Bi2 [mm]	Bi3 [mm]	Ba [mm]	R [mm]	Bending radii	Weight [kg/m]
E332.25.2.□.0	13	25	34	048	075 100 125 150 175 200	~ 0,70
E332.32.2.□.0	17	32	50	075	100 125 150 200 250	~ 0,90
E332.50.2.□.0	26	50	68	100	125 150 200 250	~ 1,40
E332.75.2.□.0	38,5	75	96	140	175 200 250 300	~ 2,35

Supplement Part No. with required radius (R). Example: E332.50.2.100.0

0 = standard color, other colors ▶ page 1.39

Part No. structure

E332.	50.2.	100.	0
-------	-------	------	---



Part No.	Pitch [mm]
E332.25	14,5
E332.32	25
E332.50	30
E332.75	36

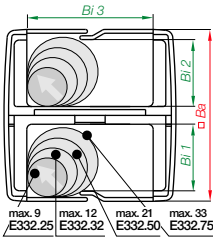

Double-axis movement - Series E332

Part No.	Bi1/Bi2 [mm]	Bi3 [mm]	Ba [mm]	R [mm]	Bending radii	Weight [kg/m]
E332.25.2.□/□.0	13	25	34	048	075 100 125 150 175 200	~ 0,70
E332.32.2.□/□.0	17	32	50	075	100 125 150 200 250	~ 0,90
E332.50.2.□/□.0	26	50	68	100	125 150 200 250	~ 1,40
E332.75.2.□/□.0	38,5	75	96	140	175 200 250 300	~ 2,35

Supplement Part No. with required radius (R). Example: E332.75.2.200/200.0

0 = standard color, other colors ▶ page 1.39

*RBR = Reversal Bending Radius

Part No. structure

E332.	75.2.	200/200.	0
-------	-------	----------	---

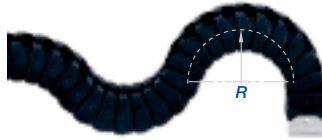
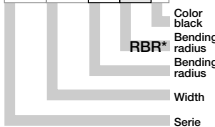

Part No.	Pitch [mm]
E332.25	14,5
E332.32	25
E332.50	30
E332.75	36

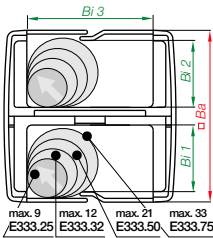

Triple-axis movement - Series E333

Part No.	Bi1/Bi2 [mm]	Bi3 [mm]	Ba [mm]	R [mm]	Bending radii	Weight [kg/m]
E333.25.□/□/□.0	13	25	34	048	075 100 125 150 175 200	~ 0,70
E333.32.□/□/□.0	17	32	50	075	100 125 150 200 250	~ 0,90
E333.50.□/□/□.0	26	50	68	100	125 150 200 250	~ 1,40
E333.75.□/□/□.0	38,5	75	96	140	175 200 250 300	~ 2,35

The bending radii are doubled in the case of the Series E333 !

Supplement Part No. with required radius (R). Example: E333.50.100/100.0

0 = standard color, other colors ▶ page 1.39

*RBR = Reversal Bending Radius

Part No. structure

E333.	50.	100/100.	0
-------	-----	----------	---

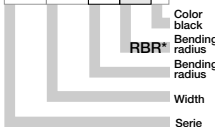

Part No.	Pitch [mm]
E333.25	14,5
E333.32	25
E333.50	30
E333.75	36



Option KMA* - The Standard

- Bolted connection outside of chain cross-section
- Split-on KMA mounting bracket
- Corrosion-resistant
- Available with or without strain relief tiwrap plates
- Universal mountable with attachment capability on all sides

*KMA = Polymer Metal Mounting Bracket

Moving end with bore
333...1PZ(B)

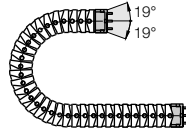

333...2PZ(B)

Fixed end with pin



These fastening variants result automatically on selection of divisible KMA mounting brackets

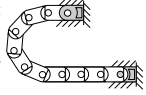

333...1PZ(B)

Moving end

333...2PZ(B)

Fixed end

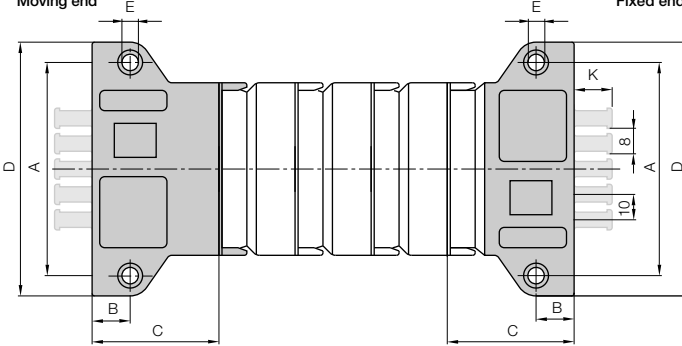

Dimensions and order configurations

For high loads, we recommend screwing the mounting brackets to the E-Chain*. Contact us if you have any questions.

Part No. structure

333.32.12.PZB.A

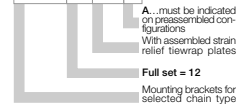

Full set, for both ends:

333.32.12.PZB + tiwrap plate

Single-part order:

333.32.1.PZB + tiwrap plate

Mounting bracket with bore

333.32.2.PZB + tiwrap plate

Mounting bracket with pin

For E-Chain*	Part No. Full set with tiwrap plate	Part No. Full set without tiwrap plate	Dim. A [mm]	Dim. B [mm]	Dim. C [mm]	Dim. D [mm]	Dim. E [mm]	Dim. K [mm]	Number of teeth
E332.25.2 / E333.25	-	333.25.12.PZ	43	7	22	52	4,5	-	-
E332.32.2 / E333.32	333.32.12.PZB	333.32.12.PZ	66	15	46	82	6,5	15	3
E332.50.2 / E333.50	333.50.12.PZB	333.50.12.PZ	84	15	50	100	6,5	15	5
E332.75.2 / E333.75	333.75.12.PZB	333.75.12.PZ	109	15	55	125	6,5	15	7

For the preassembled mode please add the index **A** eg. 333.25.12.PZB **A**

Tiwrap plate as individual part

Special tiwrap plates for Easy Triflex® with KMA mounting brackets

- Single-piece for installation inside switch cabinets or machine assembly
- Easy to assemble, no need for screws

Part No. Tiwrap plate	Width [mm]	Number of teeth	For Series
333.32.ZB	40	3	E332.32.2 / E333.32
333.50.ZB	58	5	E332.50.2 / E333.50
333.75.ZB	83	7	E332.75.2 / E333.75

Phone +49- (0) 22 03-96 49-800
Fax +49- (0) 22 03-96 49-222



▶ page 2.35



Option steel - flange

- One part for all chain widths
- Electrically conductive
- Flush mounting
- Galvanized steel
- Bolted connection outside of chain cross-section

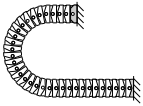

Frontal attachment option
in the case of steel flange
mounting brackets

Moving end with bore
330...1

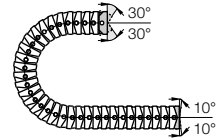

330...2

Fixed end with pin

Dimensions and order configurations

330...2
Fixed end

330...1
Moving end

Part No. structure

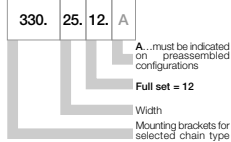

Full set, 4 parts

2 with pin / 2 with bore:

330. 25. 12

Single-part order:

330. 25. 1

Mounting bracket with bore

330. 25. 2

Mounting bracket with pin

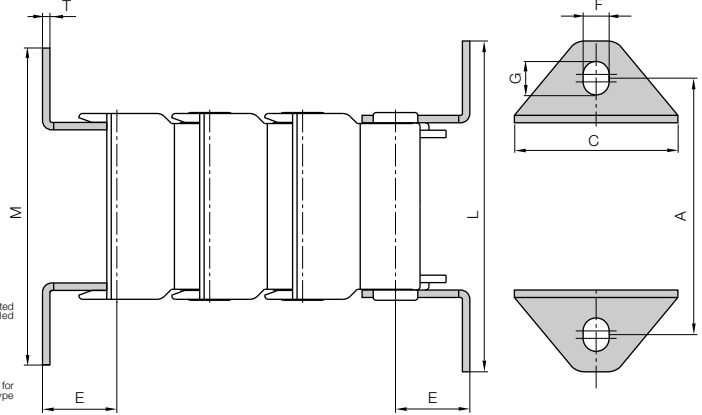

For	Part No.	A	M	C	L	T	E	F	G
E-Chain*	Full set	[mm]	[mm]	[mm]	[mm]	[mm]	[mm]	[mm]	[mm]
E332.25.2 / E333.25	330.25. 12	44	55	29	55	1,5	10,5	6,5	9
E332.32.2 / E333.32	330.32. 12	66	84	44	88	2	20	7	9
E332.50.2 / E333.50	330.50. 12	84	102	62	106	2	25	7	9
E332.75.2 / E333.75	330.75. 12	109	127	90	131	2	25	7	9

For the preassembled mode please add the index **A**, eg. 330.25. 12 **A**

Phone +49- (0) 22 03-96 49-800
Fax +49- (0) 22 03-96 49-222

igus® GmbH
51147 Cologne

Internet: www.igus.eu
E-mail: info@igus.de



Option steel - angle

- One part for all chain widths
- Bolted connection outside of chain cross-section
- Electrically conductive
- Galvanized steel
- Bolted connection outside of chain cross-section possible

Moving end with bore
338...1

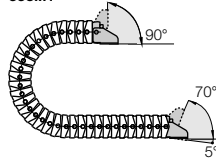

338...2

Fixed end with pin

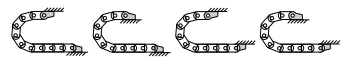

Possible installation conditions -

Further installation angles ► installation sketch

338...2

Fixed end

338...1

Moving end

Dimensions and order configurations

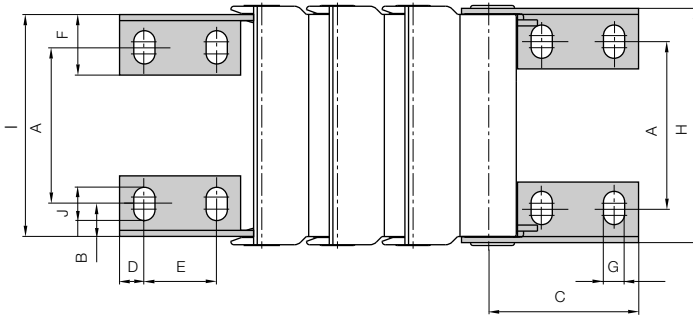

Part No. structure

338.	25.	12.
------	-----	-----

Full set = 12

Width

Mounting brackets for selected chain type

Full set, 4 parts

2 with pin / 2 with bore:

338.	25.	12
------	-----	----

Single-part order:

338.	25.	1
------	-----	---

Mounting bracket with bore

338.	25.	2
------	-----	---

Mounting bracket with pin

For	Part No.	A	B	C	D	E	F	G	H	I	J
E-Chain [†]	Full set	[mm]	[mm]	[mm]	[mm]	[mm]	[mm]	[mm]	[mm]	[mm]	[mm]
E332.25.2 / E333.25	► 338.25.12	17	6,25	28	6	16	14	5,5	33,8	31	8,5
E332.32.2 / E333.32	► 338.32.12	24	5,5	47	8	24	20	7	49	45	11
E332.50.2 / E333.50	► 338.50.12	42	5,5	77	12	35	24	9	67	62	15
E332.75.2 / E333.75	► 338.75.12	65	5,5	77	12	35	24	9	95	90	15

Phone +49- (0) 22 03-96 49-800
Fax +49- (0) 22 03-96 49-222



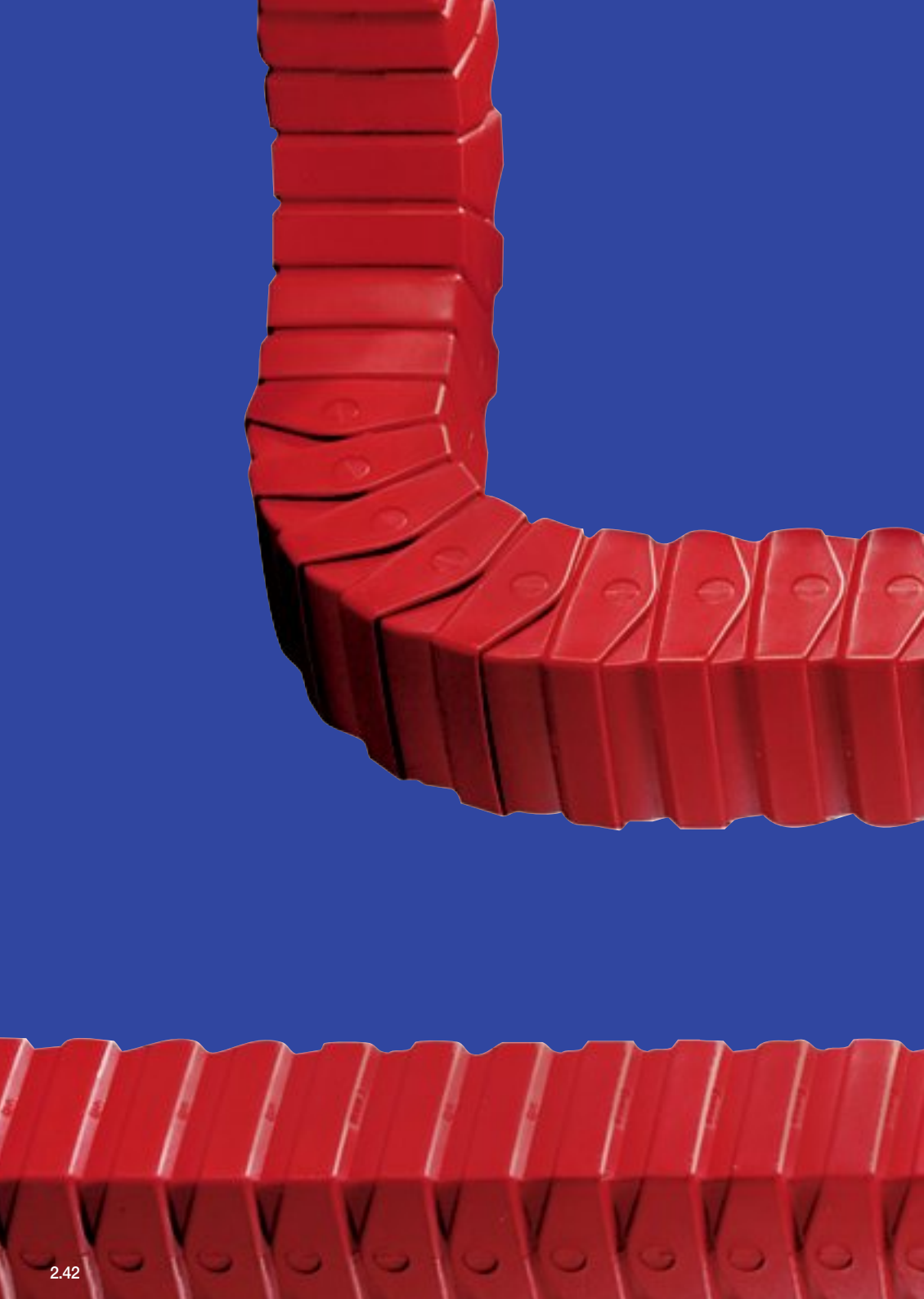

Triflex®



Triflex® - enclosed, for easy 3D applications

Triflex® - E-Chain® for 3D-motion. The Triflex® Series was developed to realize safe energy supply in the case of multi-dimensional movements. In doing so the flexibility of a hose was combined with the stability of an E-Chain® and its defined radii. The unique modular program allows you to follow very complex movements. For example: Combine 1-axis, 2-axis and 3-axis movement links in one E-Chain®.

Typical industries and applications

- Machine tools
- Robots
- Handling equipment
- Material handling
- Plastics machinery
- Construction machines
- Vehicles
- Machinery of all kinds
- Medical equipment



iF-Design awards
for Triflex® design



Torsional motion
possible



UL94-V2
classifications



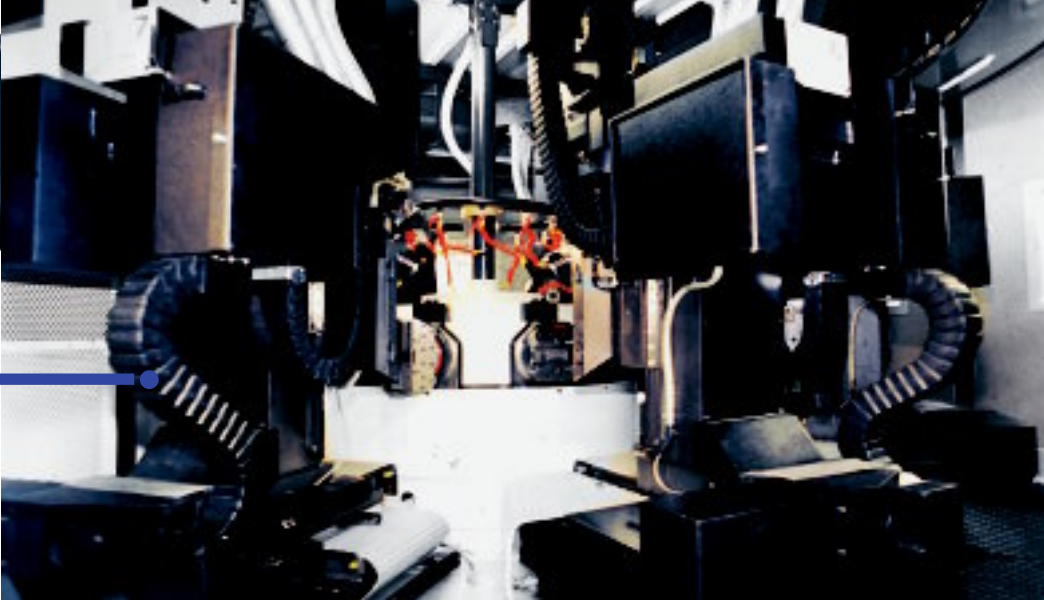

Various Triflex® tubes on the inside of a machining center



Triflex® for 3 movement directions combined with Triflex® for 1 movement direction

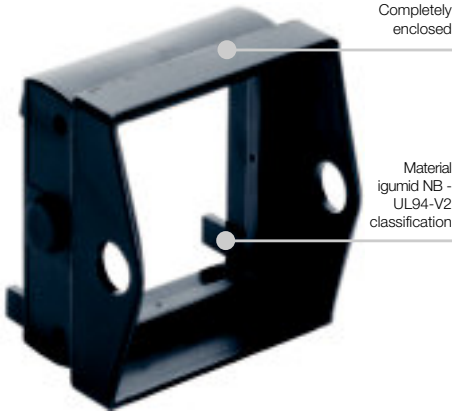

Triflex® 332 as unsupported link from machines to control desk

Select this modular, robust, E-ChainSystem® for:

- 3-axis motions in machinery of all kinds
- Dirty environments
- High tensile strength
- Where rectangular shapes fit better
- Side-mounted unsupported
- Completely enclosed - protection against dirt and chips
- Combinations of varying bending radii and moving axes
- Connecting and separating possible at every link
- Flanged mounting brackets or mounting brackets angle, galvanized steel
- Series 352 and 353 snap-open, 50 mm cross-section
- Combination Series 353/333 possible
- Cost-effective design for complex movements
- You can find more technical data about the material, chemical resistance, temperatures ► **chapter design, from page 1.38**

Selection table

Series	Inner height/Inner width □ <i>Bi</i> [mm]	Outer width/Outer height □ <i>Ba</i> [mm]	Bending radii <i>R</i> [mm]	Page
Single-axis and double-axis movement:				
332.16	16	26	038 - 100	2.48
332.32	32	50	075 - 250	2.48
332.50	50	68	100 - 250	2.48
332.75	75	96	140 - 300	2.48
Triple-axis movement:				
333.16	16	26	038 - 100	2.48
333.32	32	50	075 - 250	2.48
333.50	50	68	100 - 250	2.48
333.75	75	96	140 - 300	2.48
Snap-open Series:				
352.50	50	68	100 - 250	2.48
353.50	50	68	100 - 250	2.48

Assembling | Triflex®



1 Twist and snap in



2 Snap in pin "push-button-principle"

Separating | Triflex®



1 Release side link



2 Twist and separate

Filling | Triflex® - Serien 352 und 353



1 To open Series 352 and Series 353 only - Insert screwdriver into slot on top of lid and push down



Price index



UL94-V2 classifications upon request



Torsional motion possible



iF-Design awards for Triflex® design



Release side link, twist and separate



To open Series 352 and Series 353 only - Insert screwdriver into slot on top of lid and push down



When to use the Series 332/333/352/353:

- For applications that move within two or three axes (combined rotary and circular movements)
- If chip protection is required



When not to use them:

- For complex robotic applications
 - ▶ Triflex® R - TRC, from page 2.12
- For gliding applications, use other E-Chains/Tubes of similar dimensions
 - ▶ System E4, chapter 7
- For rotary movements
 - ▶ System TwisterChain®, from page 2.56



- ❶ KMA, flanged and angled mounting brackets available
- ❷ Combinations of varying bending radii and moving axes
- ❸ Completely enclosed
- ❹ Protection against dirt and chips
- ❺ Combination of Series 353 and Series 333 possible
- ❻ Series 352 and 353 snap-open, 50mm cross-section
- ❼ Cost-effective design for complex movements
- ❽ Assembling and separating at any given point
- ❾ High tensile strength



Order example of a complete E-Chain®

Indicate chain-lengths or number of links! Example: 2 m or 68 links

2,0 m 332.50.100/100.0

E-Chain®

with 2 separators 351 assembled every 2nd link

Interior separation

1 set 338.50.12

Mounting bracket



332.16 - single/double-axis movement

R	038	048	075	100
H	105	125	180	230
D	070	080	105	130
K	200	230	315	400

332.32 - single/double-axis movement

R	075	100	125	150	200	250
H	200	250	300	350	450	550
D	130	155	180	205	255	305
K	305	385	465	545	700	865

332.50/352.50 - single/double-axis movement

R	100	125	150	200	250
H	270	320	375	470	570
D	195	220	245	295	345
K	435	520	590	750	910

332.75 - single/double-axis movement

R	140	175	200	250	300
H	380	450	500	600	700
D	240	275	300	350	400
K	550	660	740	900	1060

333.16 - triple-axis movement

R	038	048	075	100
H	180	220	330	430
D	105	125	180	230
K	320	380	550	710

333.32 - triple-axis movement

R	075	100	125	150	200	250
H	350	450	550	650	850	1050
D	205	255	305	355	455	555
K	545	700	860	1020	1300	1605

333.50/353.50 - triple-axis movement

R	100	125	150	200	250
H	470	570	670	870	1070
D	295	345	395	495	595
K	750	910	1070	1380	1690

333.75 - triple-axis movement

R	140	175	200	250	300
H	660	800	900	1100	1300
D	380	450	500	600	700
K	990	1210	1400	1700	2000

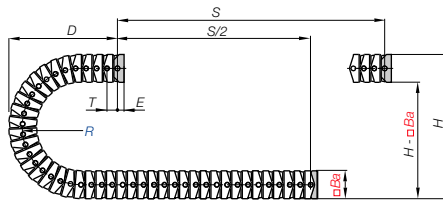

Series 332.16

Pitch = 13,3 mm
 Links/m = 76 (1011 mm)
 Dim. E = 10 mm
 Ba = 26 mm
 Chain length = $S/2 + K$

Series 332.32

Pitch = 25 mm
 Links/m = 40 (1000 mm)
 Dim. E = 20 mm
 Ba = 50 mm
 Chain length = $S/2 + K$

Series 332.50/352.50

Pitch = 30 mm
 Links/m = 34 (1020 mm)
 Dim. E = 25 mm
 Ba = 68 mm
 Chain length = $S/2 + K$

Series 332.75

Pitch = 36 mm
 Links/m = 28 (1008 mm)
 Dim. E = 25 mm
 Ba = 96 mm
 Chain length = $S/2 + K$

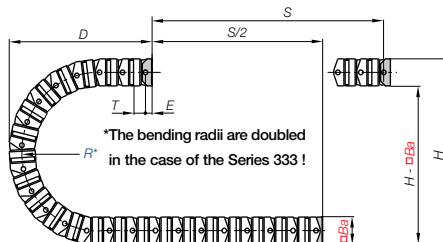

Series 333.16

Pitch = 13,3 mm
 Links/m = 76 (1011 mm)
 Dim. E = 10 mm
 Ba = 26 mm
 Chain length = $S/2 + K$

Series 333.32

Pitch = 25 mm
 Links/m = 40 (1000 mm)
 Dim. E = 20 mm
 Ba = 50 mm
 Chain length = $S/2 + K$

Series 333.50/353.50

Pitch = 30 mm
 Links/m = 34 (1020 mm)
 Dim. E = 25 mm
 Ba = 68 mm
 Chain length = $S/2 + K$

Series 333.75

Pitch = 36 mm
 Links/m = 28 (1008 mm)
 Dim. E = 25 mm
 Ba = 96 mm
 Chain length = $S/2 + K$

Technical Data



Details of material properties
 ► page 1.38

Material - permitted temperature °C

igumid NB / -40° up to +80 C

Flammability class, igumid NB

VDE 0304 IIC UL94 V2



Triflex®

Phone +49- (0) 22 03-96 49-800
 Fax +49- (0) 22 03-96 49-222



► page 2.47

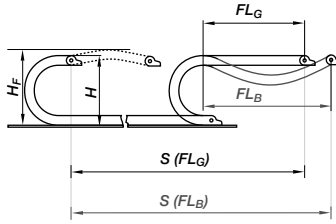

Unsupported length

FL_G = with straight upper run

FL_B = with permitted sag

Further information ► **Design**, page 1.12

S = Length of travel

H = Nominal clearance height

H_F = Required clearance height

Unsupported length 332.16

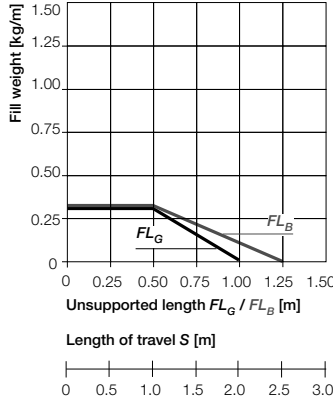

Unsupported length 332.32

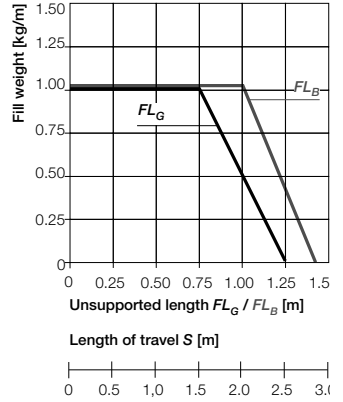

Unsupported length 332.50/352.50

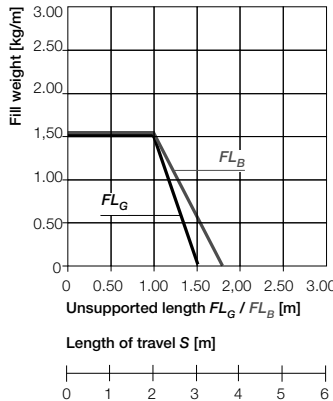

Unsupported length 332.75

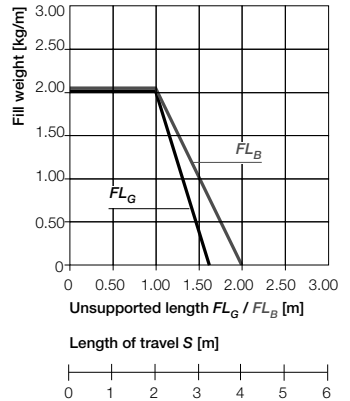

Unsupported lengths for single-axis movement only!

Single-axis movement - enclosed Series 332/snap-open Series 352

Part No.	□ Bi [mm]	□ Ba [mm]	R [mm]	Bending radii	Weight [kg/m]
332.16.□.0	16	26	038	048 075 100	≈ 0,33
332.32.□.0	32	50	075	100 125 150 200 250	≈ 0,90
332.50.□.0	50	68	100	125 150 200 250	≈ 1,40
332.75.□.0	75	96	140	175 200 250 300	≈ 2,35

Snap-open Series

352.50.□.0	50	68	100	125 150 200 250	≈ 1,40
------------	----	----	-----	-----------------	--------

Supplement Part No. with required radius (R). Example: 332.50.100.0

0 = standard color, other colors ▶ page 1.39



Part No.	Pitch [mm]
332.16	13,3
332.32	25
332.50	30
332.75	36
352.50	30

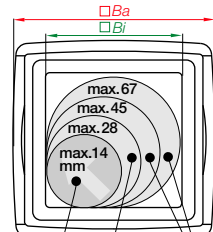

332.16 / 332.32 / 332.352.50 / 332.75

Part No. structure

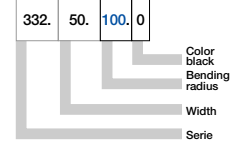

Triflex®

Double-axis movement - enclosed Series 332/snap-open Series 352

Part No.	□ Bi [mm]	□ Ba [mm]	R [mm]	Bending radii	Weight [kg/m]
332.16.□/□.0	16	26	038	048 075 100	≈ 0,33
332.32.□/□.0	32	50	075	100 125 150 200 250	≈ 0,90
332.50.□/□.0	50	68	100	125 150 200 250	≈ 1,40
332.75.□/□.0	75	96	140	175 200 250 300	≈ 2,35

Snap-open Series

352.50.□/□.0	50	68	100	125 150 200 250	≈ 1,40
--------------	----	----	-----	-----------------	--------

Supplement Part No. with required radius (R). Example: 332.50.200/200.0

0 = standard color, other colors ▶ page 1.39

*RBR = Reversal Bending Radius



Part No.	Pitch [mm]
332.16	13,3
332.32	25
332.50	30
332.75	36
352.50	30

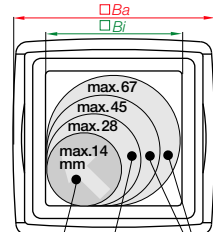

332.16 / 332.32 / 332.352.50 / 332.75

Part No. structure

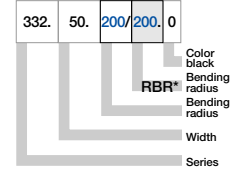

Triple-axis movement - enclosed Series 333/snap-open Series 353

Part No.	□ Bi [mm]	□ Ba [mm]	R [mm]	Bending radii	Weight [kg/m]
333.16.□/□.0	16	26	038	048 075 100	≈ 0,33
333.32.□/□.0	32	50	075	100 125 150 200 250	≈ 0,90
333.50.□/□.0	50	68	100	125 150 200 250	≈ 1,40
333.75.□/□.0	75	96	140	175 200 250 300	≈ 2,35

Snap-open Series

353.50.□/□.0	50	68	100	125 150 200 250	≈ 1,40
--------------	----	----	-----	-----------------	--------

Supplement Part No. with required radius (R). Example: 333.50.100/100.0

0 = standard color, other colors ▶ page 1.39

*RBR = Reversal Bending Radius

The bending radii are doubled in the case of the Series 333!



Part No.	Pitch [mm]
333.16	13,3
333.32	25
333.50	30
333.75	36
353.50	30

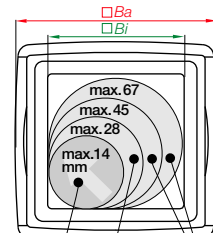

333.16 / 333.32 / 333.353.50 / 333.75

Part No. structure

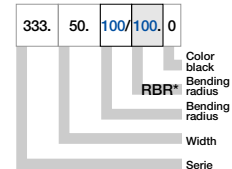

Phone +49- (0) 22 03-96 49-800
Fax +49- (0) 22 03-96 49-222

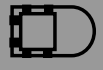

▶ page 2.47

Vertical Separators

Modular separators are available as interior separation for the igus® Triflex® System. They can be used for both vertical and horizontal sub-division. If the separators are assembled every other link and turned 90°, the tube can be sub-divided into four segments. We recommend ordering the tube preassembled, as subsequent assembly of separators is only possible after dismantling the tube. Please note that assembled separators have a different part number than unassembled separators.



Horizontal subdividing



Vertical subdividing

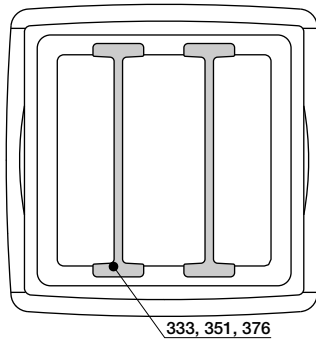

332.75/333.75

Vertical Separator

unassembled	375
assembled	376

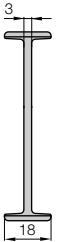
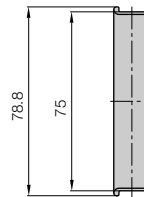

332.50/333.50/352.50/353.50

Vertical Separator

unassembled	350
assembled	351

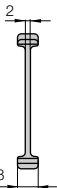
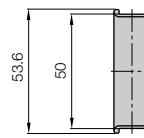

332.32/333.32

Vertical Separator

unassembled	332
assembled	333

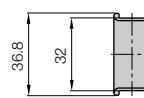



Option KMA* - The Standard

- Bolted connection outside of chain cross-section possible
- Split-on KMA mounting bracket
- Corrosion-resistant
- Available with or without strain relief tiwrap plates
- Universal mountable with attachment capability on all sides

*KMA = Polymer Metal Mounting Bracket

Moving end with bore
333...1PZ(B)

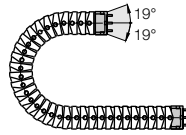

333...2PZ(B)

Fixed end with pin



These fastening variants result automatically on selection of dividable KMA mounting brackets

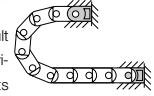

333...1PZ(B)

Moving end

333...2PZ(B)

Fixed end

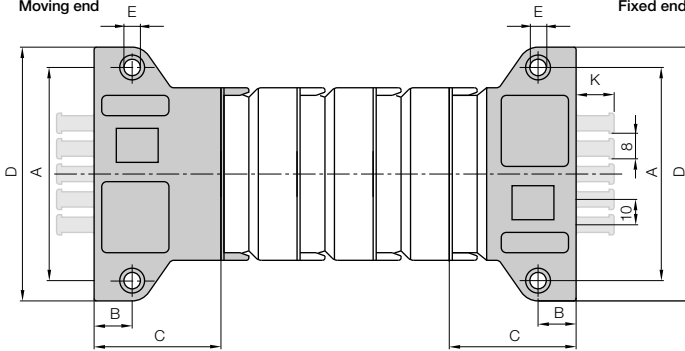

Dimensions and order configurations

For high loads, we recommend screwing the mounting brackets to the E-Chain*. Contact us if you have any questions.

Part No. structure

333.32.12.PZB A

A... must be indicated on preassembled configurations
With assembled strain relief tiwrap plates

Full set = 12
Mounting brackets for selected chain type

Full set, for both ends:

333.32.12.PZB + tiwrap plate

Single-part order:

333.32.1.PZB + tiwrap plate

Mounting bracket with bore

333.32.2.PZB + tiwrap plate

Mounting bracket with pin

For E-Chain*	Part No. Full set with tiwrap plate	Part No. Full set without tiwrap plate	Dim. A [mm]	Dim. B [mm]	Dim. C [mm]	Dim. D [mm]	Dim. E [mm]	Dim. K [mm]	Number of teeth
332.32 / 333.32	333.32.12.PZB	333.32.12.PZ	66	15	46	82	6,5	15	3
332.50 / 333.50	333.50.12.PZB	333.50.12.PZ	84	15	50	100	6,5	15	5
332.75 / 333.75	333.75.12.PZB	333.75.12.PZ	109	15	55	125	6,5	15	7
Snap-open series									
352.50 / 353.50	333.50.12.PZB	333.50.12.PZ	84	15	50	100	6,5	15	5

For the preassembled mode please add the index [A] eg. 333.32.12.PZB [A]

Tiwrap plate as individual part

Special tiwrap plates for Triflex® E-Chains®

Application: ● Single-piece for installation inside switch cabinets or machine assembly ● Accessory for igus® E-Chain systems* ● Easy to assemble, no need for screws

Part No.	Width [mm]	Number of teeth	For Series
333.32.ZB	40	3	332.32 / 333.32
333.50.ZB	58	5	332.50 / 333.50 352.50 / 353.50
333.75.ZB	83	7	332.75 / 333.75

Phone +49- (0) 22 03-96 49-800
Fax +49- (0) 22 03-96 49-222





Option steel - flange

- One part for all chain widths
- Electrically conductive
- Flush mounting
- Galvanized steel
- Bolted connection outside of chain cross-section possible

Moving end with bore
330...1

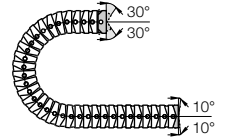

330...2

Fixed end with pin

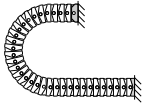

Frontal attachment option
in the case of steel flange
mounting brackets

**Dimensions and
order configurations**

330...2
Fixed end

330...1
Moving end

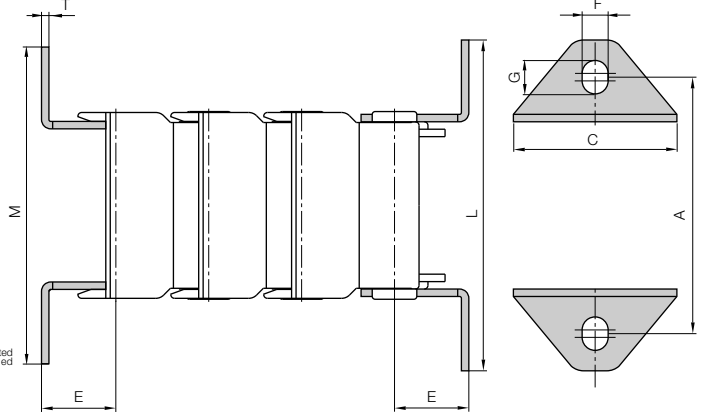

Part No. structure

330. 32. 12. A

A... must be indicated
on preassembled
configurations

Full set = 12

Width
Mounting brackets for
selected chain type

Full set, 4 parts

2 with pin / 2 with bore:

330. 32. 12

Single-part order:

330. 32. 1

Mounting bracket with bore

330. 32. 2

Mounting bracket with pin

For	Part No.	A	M	C	L	T	E	F	G
E-Chain*	Full set	[mm]	[mm]	[mm]	[mm]	[mm]	[mm]	[mm]	[mm]
332.16 / 333.16 ▶	330.16. 12	35	53	21	57	1	10	4,5	6
332.32 / 333.32 ▶	330.32. 12	66	84	44	88	2	20	7	9
332.50 / 333.50 ▶	330.50. 12	84	102	62	106	2	25	7	9
332.75 / 333.75 ▶	330.75. 12	109	127	90	131	2	25	7	9
Snap-open Series									
352.50 / 353.50 ▶	330.50. 12	84	102	62	106	2	25	7	9

For the preassembled mode please add the index **A**, eg. 330.32. 12 **A**

Phone +49- (0) 22 03-96 49-800
Fax +49- (0) 22 03-96 49-222

igus GmbH
51147 Cologne

Internet: www.igus.eu
E-mail: info@igus.de



Option steel - angle

- One part for all chain widths
- Bolted connection outside of chain cross-section possible
- Electrically conductive
- Galvanized steel
- These elements can be screwed to the floor or roof

Moving end with bore
338...1

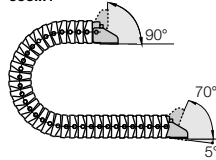

338...2

Fixed end with pin

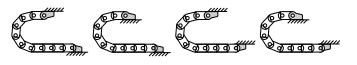

Possible installation conditions -

Further installation angles ► installation sketch

338...2
Fixed end

338...1
Moving end

Dimensions and order configurations

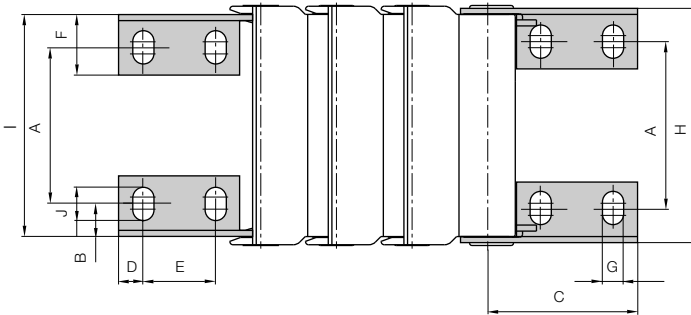

Part No. structure

338.	32.	12.
------	-----	-----



For	Part No.	A	B	C	D	E	F	G	H	I	J
E-Chain®	Full set	[mm]	[mm]	[mm]	[mm]	[mm]	[mm]	[mm]	[mm]	[mm]	[mm]
332.16 / 333.16 ►	338.16.12	12	3	25	5	10	11	4,5	25	23	6
332.32 / 333.32 ►	338.32.12	24	5,5	47	8	24	20	7	49	45	11
332.50 / 333.50 ►	338.50.12	42	5,5	77	12	35	24	9	67	62	15
332.75 / 333.75 ►	338.75.12	65	5,5	77	12	35	24	9	95	90	15
Snap-open Series											
352.50 / 353.50 ►	338.50.12	42	5,5	77	12	35	24	9	67	62	15

Full set, 4 parts

2 with pin / 2 with bore:

338.	32.	12.
------	-----	-----

Single-part order:

338.	32.	1.
------	-----	----

Mounting bracket with bore

338.	32.	2.
------	-----	----

Mounting bracket with pin

Phone +49- (0) 22 03-96 49-800
Fax +49- (0) 22 03-96 49-222



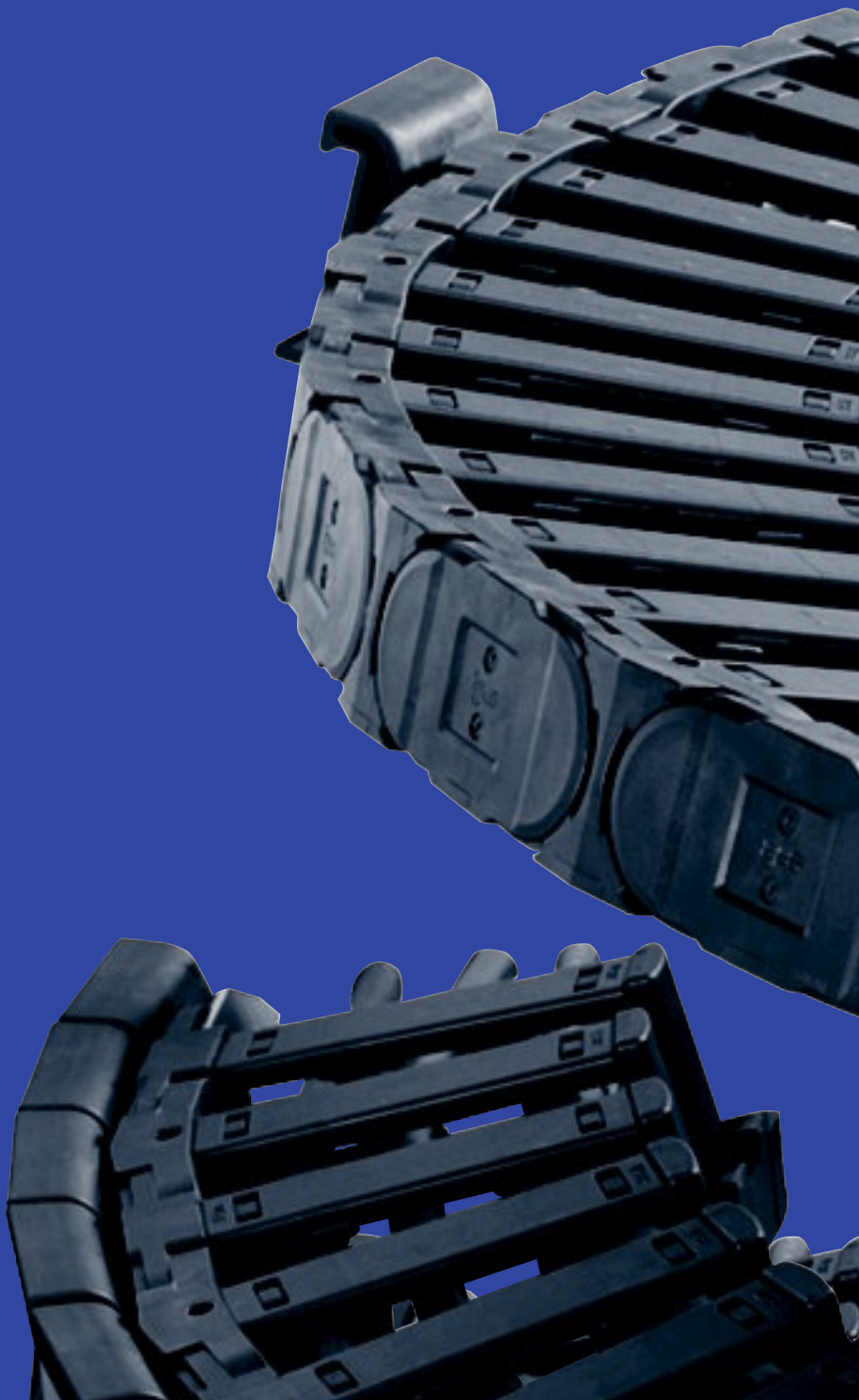



TwisterChain[®]

TwisterChain® - Circular and spiral move- ments

TwisterChain® are modular and rugged E-Chains® for circular and spiral movements. They safely supply their robots in the rotary axis with energy and media.

- Circular, spiral motions up to 540°
- Fast cable replacement
- Modular, rugged design - variable widths
- Cable-friendly interior
- Crossbars snap open on both sides
- New guide troughs Type 01 and Type 02 (up to 360° motion) available ex stock
- Variable interior separation
- Applicable in rotational speeds of up to 4 m/s
- With steel mounting brackets (electrically conductive)

Typical industries and applications

- Robots
- Handling machines
- Packaging machines
- Glass machines
- General mechanical engineering, etc



Circular movements up to 540° possible (with special attachments)



UL94-V2 classifications upon request



Two different types of Guide Trough Systems available





Combined spiral and rotary movement - igus® Series TwisterChain®



TwisterChain® for continuous industrial operation on a buckling arm robot (for welding applications, rotary movement 420°)



The robust link design allows also safety work in a dirty environment

Save assembly time and costs - Better guidance for circular motion - increase cycle life!

With the new Twister trough, the previously complex adjustment work is clearly minimized. Assembly time is reduced from 6h to 2h. While reducing noise levels, travel speed and service life can be increased, thanks to an almost all-plastic design. Now newly available for all former Twister models in the catalog program of the series 2808, 3808 and 4008 with the respective available widths and radii. Please call us!

► from page 2.70

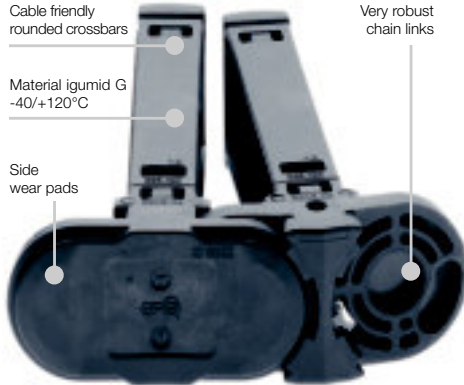

New guide trough system - Type 01

Select this modular "spiral" E-Chain® for:

- igus® TwisterChain® for circular motions up to 540° (with special attachments)
- Fast cable change
- Modular design - variable widths
- Cable-friendly interior
- Crossbars can be opened on both sides
- New Guide Troughs Type 01 and Type 02 (circular motions up to 360°) available from stock
- Variable interior separation
- In the case of rotational speeds of up to 4 m/s
- With steel (electrically conductive) mounting brackets
- You can find more technical data about the material, chemical resistance, temperatures ► **chapter design, from page 1.38**

Selection table

Series	Inner height <i>hi</i> [mm]	Inner width <i>Bi</i> [mm]	Outer width <i>Ba</i> [mm]	Outer height [mm]	Bending radii <i>R</i> [mm]	Circular radii <i>AR</i> [mm]	Page
2208.	28	52,5 - 112,5	80-140	42	055 - 150	300	2.64
2808.	32	50-150	81-181	54	100 - 250	400 - 600	2.65
3808.	42	50-200	85-235	64	100 - 250	400 - 600	2.66
4008.	56	50-200	93-243	84	150 - 400	650 - 850	2.67

Circular movements in minutes - Quickly generate complete TwisterChain® models with guide trough and accessories ► www.igus.eu/twisterconfigurator



- Preparing of 3D-models only with input of chosen E-Chain® radii and installation area
- Free positioning of the E-Chain® moving end along the travel lengths
- Generation of TwisterChain® optionally as single part or with guide trough and base support
- Fast download of the CAD files without registration
- CAD models in 11 different 3D CAD formats and 8 different 2D CAD formats



Guide Trough Type 01 - Save assembly time and costs -
Better guidance for circular motion - increase cycle life! ▶ from page 2.70



Guide Trough Type 02 - continues to be available for special applications ▶ from page 2.70





Price index



Circular movements
up to 540° possible
(with special attachments)



UL94-V2 classifications
upon request



Two different types of Guide
Trough Systems available



Opening - push a screwdriver down vertically into the opening crossbar's groove. Using the screwdriver as a lever against the horn, loosen the opening crossbar

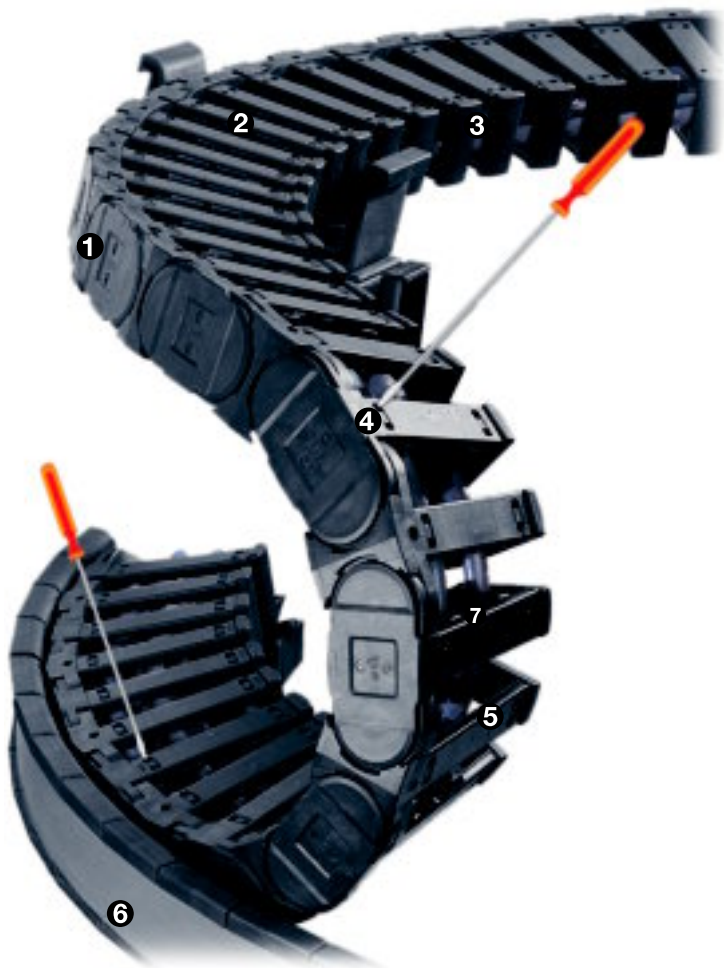

When to use TwisterChain®:

- If you require variable interior separation
- If you wish conduit access on both sides
- For rotational speeds up to 90°/s
- For spiral motion up to 540° possible (with special attachments)



When not to use it:

- In the case of very small or very large diameters
- ▶ Design, chapter 1
- For applications using rotation angles over 400° please consult igus®

- ① Spiral chain for rotary motion up to 540° (with special attachments)
- ② Modular design - variable widths
- ③ Dirt-repellent exterior
- ④ Crossbars which can be opened on both sides
- ⑤ Cable-friendly interior
- ⑥ Standard guide troughs available from stock
- ⑦ Interior separation possible



Order example of a complete E-Chain®

Indicate chain-lengths or number of links! Example: 2 m or 36 links

2,0 m 2808.087.175/500.0

E-Chain®

with 2 separators 282 assembled every 2nd link

Interior separation

1 set 28080.34

Mounting bracket



If you would like us to design your TwisterChain® application, simply supply us with your requirements. Please use the igus® System design form at the end of this chapter. If you would like to specify the chain and the guide trough yourself, please work through the following points and enter the results on the calculation sheet at the end of the chapter.



- a** = Acceleration
- α** = Rotation angle
- AR** = Outer radius, E-Chain®
- Ba** = Outer E-Chain® width
- Bi** = Inner E-Chain® width
- FZ_{max}** = Max. additional load
- H** = Nominal clearance height
- ha** = Outer E-Chain® height
- hi** = Inner E-Chain® height
- H_F** = Required clearance height
incl. 50 mm clearance
- IR** = Inner radius, E-Chain®
- K** = Series-dependent add-on for bending radius
- n** = Number of links
- R** = Bending radius
- T** = Pitch
- v** = Speed
- X₁** = Inner machine construction space
- X₂** = Outer radius, incl. clearance
- R_{LK}** = Distance pivot point/ outer mounting holes

28-56

1. Determine the series and E-Chain® width

Specify which cables you would like to use for the E-Chain®. The type of cables and the largest cable diameter determine the Series and E-Chain® width selection. We recommend that you allow for a cable clearance of approx 20% of the chain's internal height and width. For instance, you must choose Series 3808 for a cable diameter of 30 mm.

2. Specify the outer and inner radius

Determine the construction space available to you (dim. **X₁** and **X₂**)

Example: α = 220° / max. cable diameter 24 mm → **Series 2808**

X₂ = 580 mm → **AR** = 500 mm X₁ = 310 mm → **IR_{min}** = 390 mm → selection table → 392 mm

3. Specify the bending radius R

H_F = 460 mm → H ≤ 410 mm → $R = \frac{H - ha}{2} = 178 \text{ mm} \rightarrow R175^*$ ▶ **Results: Part No. 2808.087.175.500**
*next smallest radius

4. Calculate the required number of links

Number of links: $n = \frac{\pi \times AR \times \alpha}{360^\circ \times T} + \frac{K}{T}$

● The resulting number of links must always be rounded up! ● The mounting brackets may be attached only to the outside plates of the TwisterChain®. Consequently, the number of links must always **be rounded up to the next higher odd number!**

TwisterChain® - System
Inner height: 28-56 mm

Phone +49- (0) 22 03-96 49-800
Fax +49- (0) 22 03-96 49-222

Recommendations for design without additional components

E-Chain® Series	FZ _{max.} α 180° [kg/m]	FZ _{max.} α 360° [kg/m]	v an AR permitted [m/s]	a an AR [m/s²] max.	R max. [mm]	AR permitted [mm]
2208.	1,5	1	0,3 - 1	2	100	300
2808.	2	1	0,3 - 1	2	150	450 - 550
3808.	3	1,8	0,3 - 1	2	200	450 - 550
4008.	4	2,5	0,3 - 1	2	250	600 - 700

The following clearances are absolutely essential for proper design function:

$IR_{min} = X_1 + 80 \text{ mm}$
 $X_{2 min} = AR + 80 \text{ mm}$
 $H_F = H + 50 \text{ mm}$

If your calculations exceed our recommendations, please talk to us.

We offer special solutions and many additional components!

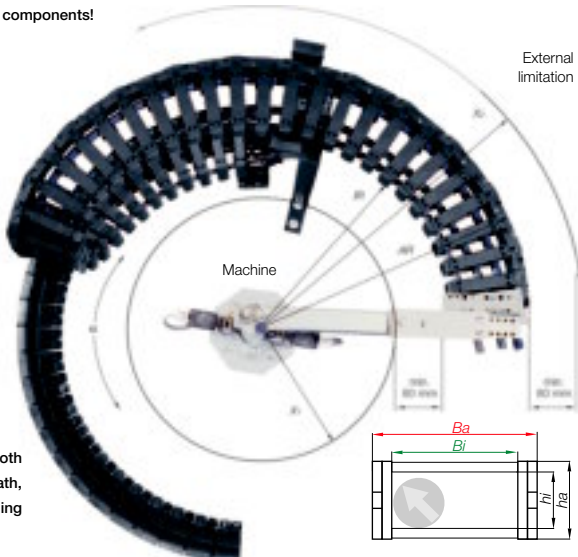

In the case of machine elements which move both to the left and to the right following a circular path, the angle of rotation can be determined by adding the two angles!

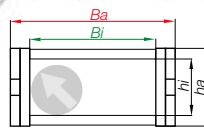

Serie 2208 - snap-open along inner and outer radius

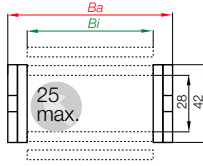
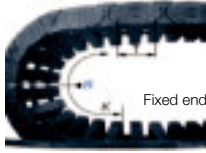

R [mm]	K	T [mm]
055	265	044
063	290	044
075	330	044
100	410	044
125	485	044
150	565	044

Part No. structure

2208	062	75/	300	0
------	-----	-----	-----	---



Bi [mm]	Ba [mm]	AR [mm]	IR [mm]	R 055 mm 2208....	R 063 mm 2208....	R 075 mm 2208....	R 100 mm 2208....	R 125 mm 2208....	R 150 mm 2208....	Weights [kg/m]
52,5	80	300	227	.052.055/300	.052.063/300	.052.075/300	.052.100/300	.052.125/300	.052.150/300	≈ 1,20
62,5	90	300	217	-	-	.062.075/300	.062.100/300	.062.125/300	.062.150/300	≈ 1,24
74,5	102	300	205	-	-	-	.074.100/300	.074.125/300	.074.150/300	≈ 1,29
87,5	115	300	192	-	-	-	.087.100/300	.087.125/300	.087.150/300	≈ 1,35
112,5	140	300	167	-	-	-	-	.112.125/300	.112.150/300	≈ 1,46



Interior separation - For this Series the interior separation elements of Serie E4.28 E4.1 may be used (except side-plates) ► page 7.28



Serie 2808 - snap-open along inner and outer radius

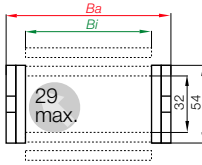
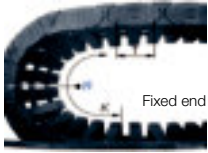

R [mm]	K	T [mm]
100	465	056
125	550	056
150	620	056
175	700	056
200	780	056
250	940	056

Part No. structure

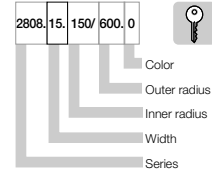

Bi [mm]	Ba [mm]	AR [mm]	IR [mm]	R 100 mm 2808....	R 125 mm 2808....	R 150 mm 2808....	R 175 mm 2808....	R 200 mm 2808....	R 250 mm 2808....	Weights [kg/m]
50	81	400	329,5	.05.100/400	.05.125/400	.05.150/400	.05.175/400	.05.200/400	.05.250/400	≈ 1,76
68	99	400	311,5	.06.100/400	.06.125/400	.06.150/400	.06.175/400	.06.200/400	.06.250/400	≈ 1,87
75	106	400	304,5	.07.100/400	.07.125/400	.07.150/400	.07.175/400	.07.200/400	.07.250/400	≈ 1,92
87,5	118,5	400	292	.087.100/400	.087.125/400	.087.150/400	.087.175/400	.087.200/400	.087.250/400	≈ 1,99
100	131	400	279,5	-	-	.10.150/400	.10.175/400	.10.200/400	.10.250/400	≈ 2,07
108	139	400	271,5	-	-	-	.11.175/400	.11.200/400	.11.250/400	≈ 2,12
125	156	400	254,5	-	-	-	.12.175/400	.12.200/400	.12.250/400	≈ 2,22
137,5	168,5	400	242	-	-	-	-	.137.250/400	-	≈ 2,30
150	181	400	229,5	-	-	-	-	-	.15.250/400	≈ 2,38

50	81	500	429,5	.05.100/500	.05.125/500	.05.150/500	.05.175/500	.05.200/500	.05.250/500	≈ 1,76
68	99	500	411,5	.06.100/500	.06.125/500	.06.150/500	.06.175/500	.06.200/500	.06.250/500	≈ 1,87
75	106	500	404,5	.07.100/500	.07.125/500	.07.150/500	.07.175/500	.07.200/500	.07.250/500	≈ 1,92
87,5	118,5	500	392	.087.100/500	.087.125/500	.087.150/500	.087.175/500	.087.200/500	.087.250/500	≈ 1,99
100	131	500	379,5	.10.100/500	.10.125/500	.10.150/500	.10.175/500	.10.200/500	.10.250/500	≈ 2,07
108	139	500	371,5	-	.11.125/500	.11.150/500	.11.175/500	.11.200/500	.11.250/500	≈ 2,12
125	156	500	354,5	-	.12.125/500	.12.150/500	.12.175/500	.12.200/500	.12.250/500	≈ 2,22
137,5	168,5	500	342	-	-	.137.150/500	.137.175/500	.137.200/500	.137.250/500	≈ 2,30
150	181	500	329,5	-	-	.15.150/500	.15.175/500	.15.200/500	.15.250/500	≈ 2,38

50	81	600	529,5	.05.100/600	.05.125/600	.05.150/600	.05.175/600	.05.200/600	.05.250/600	≈ 1,76
68	99	600	511,5	.06.100/600	.06.125/600	.06.150/600	.06.175/600	.06.200/600	.06.250/600	≈ 1,87
75	106	600	504,5	.07.100/600	.07.125/600	.07.150/600	.07.175/600	.07.200/600	.07.250/600	≈ 1,92
87,5	118,5	600	492	.087.100/600	.087.125/600	.087.150/600	.087.175/600	.087.200/600	.087.250/600	≈ 1,99
100	131	600	479,5	.10.100/600	.10.125/600	.10.150/600	.10.175/600	.10.200/600	.10.250/600	≈ 2,07
108	139	600	471,5	.11.100/600	.11.125/600	.11.150/600	.11.175/600	.11.200/600	.11.250/600	≈ 2,12
125	156	600	454,5	-	.12.125/600	.12.150/600	.12.175/600	.12.200/600	.12.250/600	≈ 2,22
137,5	168,5	600	442	-	.137.125/600	.137.150/600	.137.175/600	.137.200/600	.137.250/600	≈ 2,30
150	181	600	429,5	-	-	.15.150/600	.15.175/600	.15.200/600	.15.250/600	≈ 2,38



Interior separation - For this Series the interior separation elements of Series E4.32 E4.1 may be used (except side-plates) ▶ page 7.38



TwisterChain®-System
Inner height: 28-56 mm

Phone +49- (0) 22 03-96 49-800
Fax +49- (0) 22 03-96 49-222



Serie 3808 - snap-open along inner and outer radius

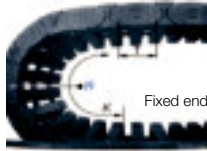

Fixed end

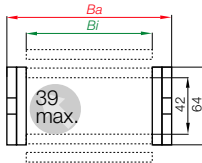

R [mm]	K	T [mm]
100	500	067
125	650	067
150	725	067
200	875	067
250	1050	067

Part No. structure

3808.20.200.600.0



Color
Outer radius
Inner radius
Width
Series

Bi [mm]	Ba [mm]	AR [mm]	IR [mm]	R 100 mm 3808....	R 125 mm 3808....	R 150 mm 3808....	R 200 mm 3808....	R 250 mm 3808....	Weights [kg/m]
50	85	400	327,5	.05.100/400	.05.125/400	.05.150/400	.05.200/400	.05.250/400	≈ 2,21
68	103	400	309,5	.06.100/400	.06.125/400	.06.150/400	.06.200/400	.06.250/400	≈ 2,30
75	110	400	302,5	.07.100/400	.07.125/400	.07.150/400	.07.200/400	.07.250/400	≈ 2,33
87,5	122,5	400	290	.087.100/400	.087.125/400	.087.150/400	.087.200/400	.087.250/400	≈ 2,40
100	135	400	277,5	.10.100/400	.10.125/400	.10.150/400	.10.200/400	.10.250/400	≈ 2,46
108	143	400	269,5	-	.11.125/400	.11.150/400	.11.200/400	.11.250/400	≈ 2,50
125	160	400	252,5	-	.12.125/400	.12.150/400	.12.200/400	.12.250/400	≈ 2,59
137,5	172,5	400	240	-	.137.125/400	.137.150/400	.137.200/400	.137.250/400	≈ 2,65
150	185	400	227,5	-	-	-	.15.200/400	.15.250/400	≈ 2,72
162,5	197,5	400	215	-	-	-	.162.200/400	.162.250/400	≈ 2,78
168	203	400	209,5	-	-	-	-	.17.250/400	≈ 2,81
175	210	400	202,5	-	-	-	-	.18.250/400	≈ 2,84
187,5	222,5	400	190	-	-	-	-	-	≈ 2,91
200	235	400	177,5	-	-	-	-	-	≈ 2,97
50	85	500	427,5	.05.100/500	.05.125/500	.05.150/500	.05.200/500	.05.250/500	≈ 2,21
68	103	500	409,5	.06.100/500	.06.125/500	.06.150/500	.06.200/500	.06.250/500	≈ 2,30
75	110	500	402,5	.07.100/500	.07.125/500	.07.150/500	.07.200/500	.07.250/500	≈ 2,33
87,5	122,5	500	390	.087.100/500	.087.125/500	.087.150/500	.087.200/500	.087.250/500	≈ 2,40
100	135	500	377,5	.10.100/500	.10.125/500	.10.150/500	.10.200/500	.10.250/500	≈ 2,46
108	143	500	369,5	-	.11.125/500	.11.150/500	.11.200/500	.11.250/500	≈ 2,50
125	160	500	352,5	-	.12.125/500	.12.150/500	.12.200/500	.12.250/500	≈ 2,59
137,5	172,5	500	340	-	-	.137.150/500	.137.200/500	.137.250/500	≈ 2,65
150	185	500	327,5	-	-	.15.150/500	.15.200/500	.15.250/500	≈ 2,72
162,5	197,5	500	315	-	-	-	.162.200/500	.162.250/500	≈ 2,78
168	203	500	309,5	-	-	-	.17.200/500	.17.250/500	≈ 2,81
175	210	500	302,5	-	-	-	.18.200/500	.18.250/500	≈ 2,84
187,5	222,5	500	290	-	-	-	.187.200/500	.187.250/500	≈ 2,91
200	235	500	277,5	-	-	-	.20.200/500	.20.250/500	≈ 2,97
50	85	600	527,5	.05.100/600	.05.125/600	.05.150/600	.05.200/600	.05.250/600	≈ 2,21
68	103	600	509,5	.06.100/600	.06.125/600	.06.150/600	.06.200/600	.06.250/600	≈ 2,30
75	110	600	502,5	.07.100/600	.07.125/600	.07.150/600	.07.200/600	.07.250/600	≈ 2,33
87,5	122,5	600	490	.087.100/600	.087.125/600	.087.150/600	.087.200/600	.087.250/600	≈ 2,40
100	135	600	477,5	.10.100/600	.10.125/600	.10.150/600	.10.200/600	.10.250/600	≈ 2,46
108	143	600	469,5	.11.100/600	.11.125/600	.11.150/600	.11.200/600	.11.250/600	≈ 2,50
125	160	600	452,5	.12.100/600	.12.125/600	.12.150/600	.12.200/600	.12.250/600	≈ 2,59
137,5	172,5	600	440	.137.100/600	.137.125/600	.137.150/600	.137.200/600	.137.250/600	≈ 2,65
150	185	600	427,5	.15.100/600	.15.125/600	.15.150/600	.15.200/600	.15.250/600	≈ 2,72
162,5	197,5	600	415	-	-	-	.162.200/600	.162.250/600	≈ 2,78
168	203	600	409,5	-	-	-	.17.200/600	.17.250/600	≈ 2,81
175	210	600	402,5	-	-	-	.18.200/600	.18.250/600	≈ 2,84
187,5	222,5	600	390	-	-	-	.187.200/600	.187.250/600	≈ 2,91
200	235	600	377,5	-	-	-	.20.200/600	.20.250/600	≈ 2,97



Interior separation - For this Series the interior separation elements of

Series E4.42 E4.1 may be used ▶ page 7.52



Serie 4008 - snap-open along inner and outer radius

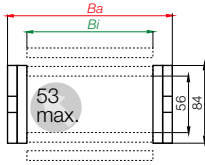
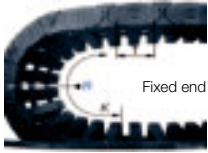

R [mm]	K	T [mm]
150	750	091
200	900	091
250	1050	091
300	1225	091
400	1450	091

Part No. structure

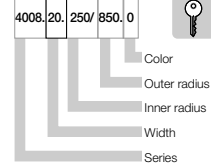

Bi [mm]	Ba [mm]	AR [mm]	IR [mm]	R 150 mm	R 200 mm	R 250 mm	R 300 mm	R 400 mm	Weights [kg/m]
50	93	650	572	.05.150/650	.05.200/650	.05.250/650	.05.300/650	.05.400/650	≈ 3,28
65	108	650	557	.06.150/650	.06.200/650	.06.250/650	.06.300/650	.06.400/650	≈ 3,38
75	118	650	547	.07.150/650	.07.200/650	.07.250/650	.07.300/650	.07.400/650	≈ 3,44
100	143	650	522	-	.10.200/650	.10.250/650	.10.300/650	.10.400/650	≈ 3,61
112	155	650	510	-	.11.200/650	.11.250/650	.11.300/650	.11.400/650	≈ 3,69
125	168	650	497	-	.12.200/650	.12.250/650	.12.300/650	.12.400/650	≈ 3,77
137,5	180,5	650	484,5	-	-	.13.250/650	.13.300/650	.13.400/650	≈ 3,86
150	193	650	472	-	-	.15.250/650	.15.300/650	.15.400/650	≈ 3,94
162,5	205,5	650	459,5	-	-	.16.250/650	.16.300/650	.16.400/650	≈ 4,02
175	218	650	447	-	-	-	.17.300/650	.17.400/650	≈ 4,10
187,5	230,5	650	434,5	-	-	-	.18.300/650	.18.400/650	≈ 4,19
200	243	650	422	-	-	-	-	-	≈ 4,27

50	93	750	672	.05.150/750	.05.200/750	.05.250/750	.05.300/750	.05.400/750	≈ 3,28
65	108	750	657	.06.150/750	.06.200/750	.06.250/750	.06.300/750	.06.400/750	≈ 3,38
75	118	750	647	.07.150/750	.07.200/750	.07.250/750	.07.300/750	.07.400/750	≈ 3,44
100	143	750	622	.10.150/750	.10.200/750	.10.250/750	.10.300/750	.10.400/750	≈ 3,61
112	155	750	610	.11.150/750	.11.200/750	.11.250/750	.11.300/750	.11.400/750	≈ 3,69
125	168	750	597	-	.12.200/750	.12.250/750	.12.300/750	.12.400/750	≈ 3,77
137,5	180,5	750	584,5	-	.13.200/750	.13.250/750	.13.300/750	.13.400/750	≈ 3,86
150	193	750	572	-	.15.200/750	.15.250/750	.15.300/750	.15.400/750	≈ 3,94
162,5	205,5	750	559,5	-	.16.200/750	.16.250/750	.16.300/750	.16.400/750	≈ 4,02
175	218	750	547	-	-	.17.250/750	.17.300/750	.17.400/750	≈ 4,10
187,5	230,5	750	534,5	-	-	.18.250/750	.18.300/750	.18.400/750	≈ 4,19
200	243	750	522	-	-	.20.250/750	.20.300/750	.20.400/750	≈ 4,27

50	93	850	772	.05.150/850	.05.200/850	.05.250/850	.05.300/850	.05.400/850	≈ 3,28
65	108	850	757	.06.150/850	.06.200/850	.06.250/850	.06.300/850	.06.400/850	≈ 3,38
75	118	850	747	.07.150/850	.07.200/850	.07.250/850	.07.300/850	.07.400/850	≈ 3,44
100	143	850	722	.10.150/850	.10.200/850	.10.250/850	.10.300/850	.10.400/850	≈ 3,61
112	155	850	710	.11.150/850	.11.200/850	.11.250/850	.11.300/850	.11.400/850	≈ 3,69
125	168	850	697	.12.150/850	.12.200/850	.12.250/850	.12.300/850	.12.400/850	≈ 3,77
137,5	180,5	850	684,5	-	.13.200/850	.13.250/850	.13.300/850	.13.400/850	≈ 3,86
150	193	850	672	-	.15.200/850	.15.250/850	.15.300/850	.15.400/850	≈ 3,94
162,5	205,5	850	659,5	-	.16.200/850	.16.250/850	.16.300/850	.16.400/850	≈ 4,02
175	218	850	647	-	.17.200/850	.17.250/850	.17.300/850	.17.400/850	≈ 4,10
187,5	230,5	850	634,5	-	.18.200/850	.18.250/850	.18.300/850	.18.400/850	≈ 4,19
200	243	850	622	-	-	.20.250/850	.20.300/850	.20.400/850	≈ 4,27

Interior separation - For this Series the interior separation elements of Series E4.56 E4.1 may be used ▶ page 7.66



TwisterChain®-System
Inner height: 28-56 mm

Phone +49- (0) 22 03-96 49-800
Fax +49- (0) 22 03-96 49-222



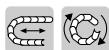

Steel mounting brackets

- One part for all chain widths
- Electrically conductive
- Universal use
- Material: Stainless steel: 1.4301



Part 1

Part 2

Dimensions and order configurations

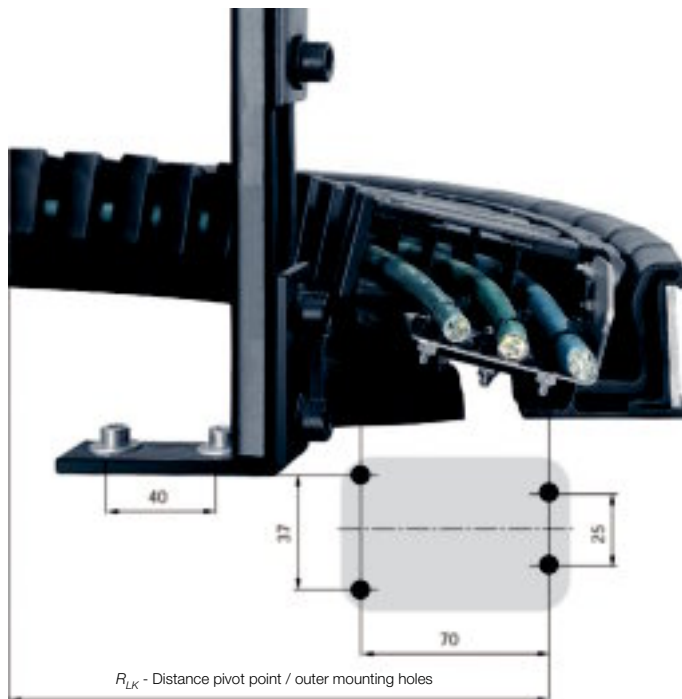

Phone +49- (0) 22 03-96 49-800
Fax +49- (0) 22 03-96 49-222

igus® GmbH
51147 Cologne

Part No. structure

22080. 34. E



For E-Chain®	Part No. Full set	Part No. Part 1	Part No. Part 2
2208 ▶	22080. 34 .E	22080. 30 .E	22080. 40 .E
2808 ▶	28080. 34 .E	28080. 30 .E	28080. 40 .E
3808 ▶	38080. 34 .E	38080. 30 .E	38080. 40 .E
4008 ▶	40080. 34 .E	40080. 30 .E	40080. 40 .E

Full set, for both ends

22080. 34. E

Single-part order - Part 1:

22080. 30. E

Single-part order - Part 2:

22080. 40. E

The guide trough must be mounted at the fixed point of the TwisterChain®, as shown by the drilling template in the illustration. The following bolted connections are permitted:

- Bore Hole: 4 x Ø 6,6 - 7 mm
- Mounting only with bolts: 4 x bolts M6

Other connection dimensions for mounting the guide trough ▶ from page 2.71

Internet: www.igus.eu
E-mail: info@igus.de



TwisterChain® for continuous industrial duty in 3-shift operation on a buckling arm robot (for welding applications, rotary movement 420°)



TwisterChain® in a guide trough for rotary movements on an articulated robot

TwisterChain®-System
Inner height: 28-56 mm

Phone +49- (0) 22 03-96 49-800
Fax +49- (0) 22 03-96 49-222



Save assembly time and costs - Better guidance for circular motion - increase cycle life!

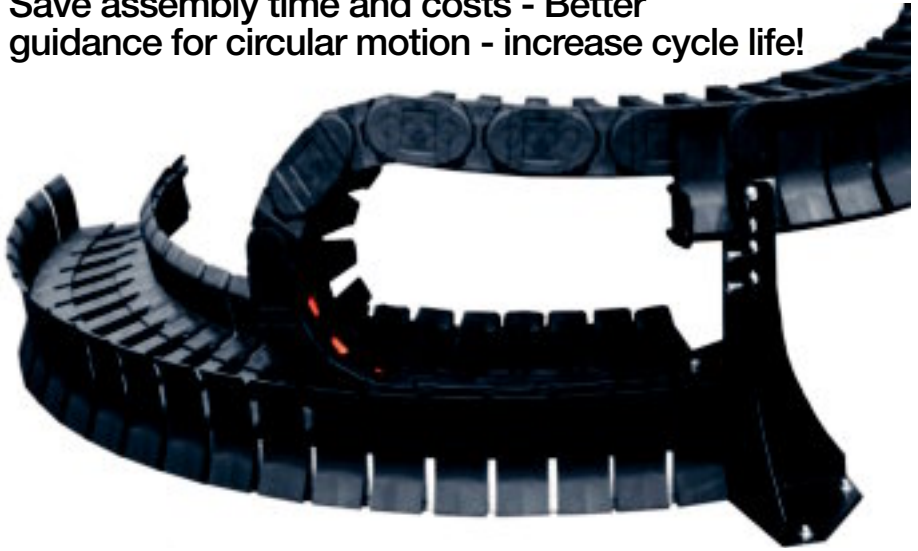

With the new Twister trough, the previously complex adjustment work is clearly minimized. Assembly time is reduced from 6h to 2h. While reducing noise levels, travel speed and service life can be increased, thanks to an almost all-plastic design. Now newly available for all former Twister models in the catalog program of the series 2808, 3808 and 4008 with the respective available widths and radii. Please call us!

- Suitable for high dynamics, because of the full and all-side guidance of the TwisterChain®
- Much smoother and quieter motion of the TwisterChain® in the trough due to continuous guidance of upper run
- Upper run guided in the new polymer trough over the full width
- Preassembled delivery possible
- Easy adjustment and alignment and handling
- Assembly time reduced from 6 hours to 2 hours

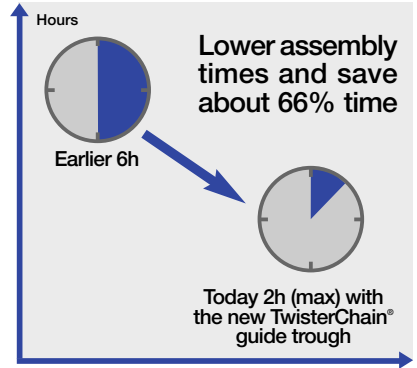

With the new Twister trough, the previously complex adjustment work is clearly minimized



Easy adjustment and alignment on the robot, due to the pre-defined angles and pre-drilled mounting holes for height-fixation

Upper run

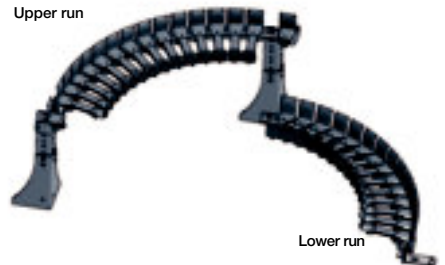

Lower run

Less parts, easier handling - Illustration shows a 180° application

For Series	Outer radius AR [mm]	Rotation angle α [°]	Trough Type 01 complete
2808 / 3808	400 mm	0 - 90°	9[XXXX].31.90.400/[Bi].R
		90° - 180°	9[XXXX].31.180.400/[Bi].R
		180° - 270°	9[XXXX].31.270.400/[Bi].R
		270° - 360°	9[XXXX].31.360.400/[Bi].R
	550 mm	0 - 90°	9[XXXX].31.90.500/[Bi].R
		90° - 180°	9[XXXX].31.180.500/[Bi].R
		180° - 270°	9[XXXX].31.270.500/[Bi].R
		270° - 360°	9[XXXX].31.360.500/[Bi].R
	600 mm	0 - 90°	9[XXXX].31.90.600/[Bi].R
		90° - 180°	9[XXXX].31.180.600/[Bi].R
		180° - 270°	9[XXXX].31.270.600/[Bi].R
		270° - 360°	9[XXXX].31.360.600/[Bi].R
4008	650 mm	0 - 90°	9[4008].31.90.400/[Bi].R
		90° - 180°	9[4008].31.180.400/[Bi].R
		180° - 270°	9[4008].31.270.400/[Bi].R
		270° - 360°	9[4008].31.360.400/[Bi].R
	750 mm	0 - 90°	9[4008].31.90.400/[Bi].R
		90° - 180°	9[4008].31.180.400/[Bi].R
		180° - 270°	9[4008].31.270.400/[Bi].R
		270° - 360°	9[4008].31.360.400/[Bi].R
	850 mm	0 - 90°	9[4008].31.90.400/[Bi].R
		90° - 180°	9[4008].31.180.400/[Bi].R
		180° - 270°	9[4008].31.270.400/[Bi].R
		270° - 360°	9[4008].31.360.400/[Bi].R

Supplement Part No. with required Series (2808, 3808 or 4008), the value *Bi*

and the corresponding value of the required bending radius *R* ▶ 9[4008].31.180.600/[06].250

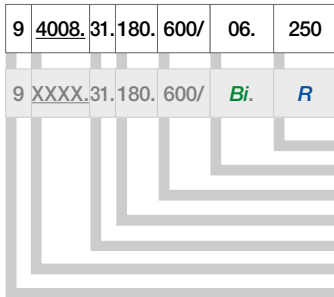

Part No. structure - guide trough
94008.31.180.600/06.250

- Bending radius, please add appropriate value
- Bi* - widths index, please add appropriate value
- Outer radius
- Trough angle (90°, 180°, 270°, 360°)
- Trough version
- Selected Series (2208, 2808, 3808 or 4008)
- Guide trough

More order examples

- Complete system (E-Chain®, mounting bracket and trough) = Part. No. 94008.180.600/06.250.0
- Complete trough = Part. No. 94008.31.180.600/06.250.0
- Only lower run trough = Part. No. 94008.30.180.600/06.250.0
- Upper and lower run trough without base support = Part. No. 94008.32.180.600/06.250.0

TwisterChain®-System
Inner height: 28-56 mm

Phone +49- (0) 22 03-96 49-800
Fax +49- (0) 22 03-96 49-222



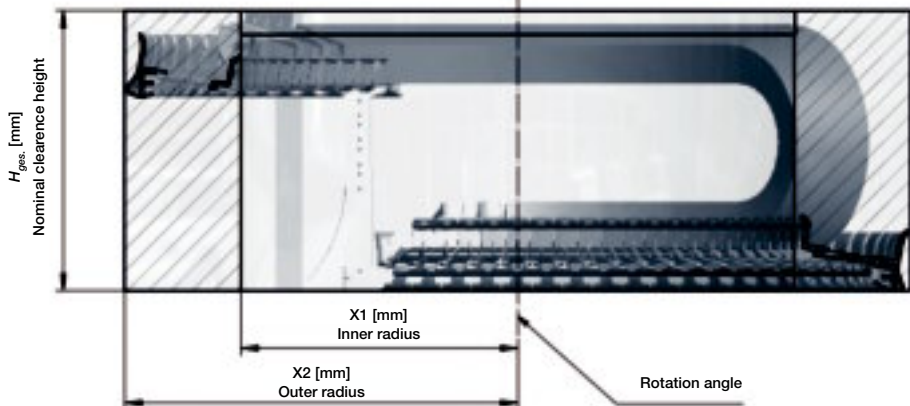

Installation Dimensions - X_1 / X_2

AR [mm]	X_2 Outer radius	X_1 Inner radius											
		$Bi = 50$ [mm]	$Bi = 65$ [mm]	$Bi = 75$ [mm]	$Bi = 100$ [mm]	$Bi = 112$ [mm]	$Bi = 125$ [mm]	$Bi = 137$ [mm]	$Bi = 150$ [mm]	$Bi = 162$ [mm]	$Bi = 175$ [mm]	$Bi = 187$ [mm]	$Bi = 200$ [mm]
400	480	290	280	270	250	240	220	210	200	190	180	170	150
500	580	390	380	370	350	340	320	310	300	290	280	270	250
600	680	490	480	470	450	440	420	410	400	390	380	370	350
650	730	540	530	520	500	490	470	460	450	440	430	420	400
750	830	640	630	620	600	590	570	560	550	540	530	520	500
850	930	740	730	720	700	690	670	660	650	640	630	620	600

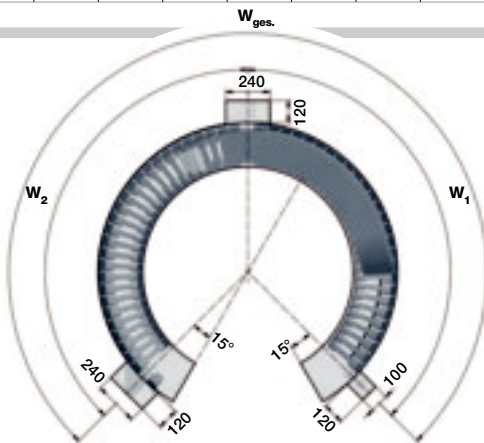
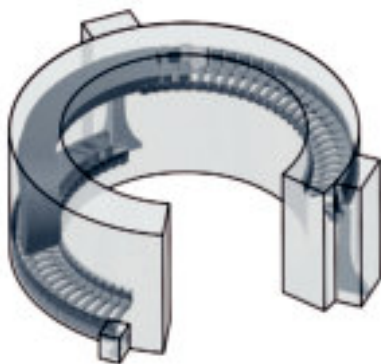

The required clearance height
of the TwisterChain® trough system

Nominal clearance height - H_{ges}

For	H_{ges} [mm] height						
Series	R 100	R 125	R 150	R 175	R 200	R 250	R 400
2808	370	420	470	520	570	670	970
3808	380	430	480	530	580	680	980
4008	400	450	500	550	600	700	1000

Rotation angle - $W_1 / W_2 / W_{ges}$

W_{ges} Machine	W_1 angle Lower run rotation angle [°]	W_2 angle Upper run rotation angle [°]
90°	45°	-
180°	90°	90°
270°	135°	135°
360°	180°	180°



TwisterChain® in the new igus®
guide trough for rotary movements
in a buckling arm robot -
Durable and rugged: Prototype
successfully tested in over
1,000,000 cycles (as on 04/2009)

TwisterChain®-System
Inner height: 28-56 mm

Phone +49- (0) 22 03-96 49-800
Fax +49- (0) 22 03-96 49-222

Circular movements in minutes - Quickly generate complete TwisterChain® models with guide trough and accessories ► www.igus.eu/twisterconfigurator



- Preparing of 3D-models only with input of chosen E-Chain® radii and installation area
- Free positioning of the E-Chain® moving end along the travel lengths
- Generation of TwisterChain® optionally as single part or with guide trough and base support
- Fast download of the CAD files without registration
- CAD models in 11 different 3D CAD formats and 8 different 2D CAD formats



Guide Troughs - TwisterChain®

The delivery of an igus® TwisterChain® includes the guide trough, which offers certain advantages:

- Guidance of the chain
- Minimized wear on the chain
- Optimal running smoothness
- Rotation angle up to 400°

The modular design of the guide trough makes it possible to connect a large number of chain, circle and bending radii by using the same trough sections. If the chain radius changes, the trough can simply be adapted without purchasing a completely new trough. The table below will assist you in selecting the right guide trough system. The specified part number includes the complete trough system. In all cases, you should state the TwisterChain® type when ordering.



This bottom support is required only if the support for the upper run (from a 180° rotation angle) cannot be mounted on the machine

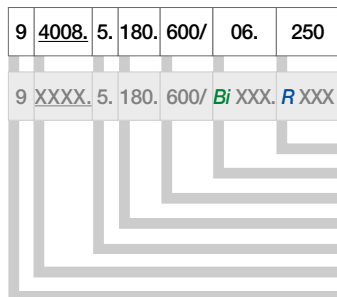

Part No. structure - guide trough
94008.5.180.600/06.250

- Bending radius, please add appropriate value
- Bi - widths index, please add appropriate value
- Outer radius
- Trough angle (Standard 180°, 135°, 90°, 45°)
- Trough version (.5. with and .4. without bottom support)
- Selected Series (2208, 2808, 3808 or 4008)
- Guide trough

Part No. Series	Outer radius AR [mm]	Rotation angle α [°]	Trough assembly Standard			Trough assembly with bottom support	Number of support					
			9	XXXX	Bi XXX			R XXX				
2208	- 300	45 - 100	9	2208	4.45.300/	Bi XXX	R XXX	not necessary				
	- 300	>100 - 180	9	2208	4.90.300/	Bi XXX	R XXX	not necessary				
	- 300	>180 - 270	9	2208	4.135.300/	Bi XXX	R XXX*	9	2208 5.135.300/	Bi XXX	R XXX	1
	- 300	>270 - 360	9	2208	4.180.300/	Bi XXX	R XXX**	9	2208 5.180.300/	Bi XXX	R XXX	2
2808 / 3808 / 4008	- 450	45 - 100	9	XXXX	4.45.400/	Bi XXX	R XXX	not necessary				
	- 450	>100 - 180	9	XXXX	4.90.400/	Bi XXX	R XXX	not necessary				
	- 450	>180 - 270	9	XXXX	4.135.400/	Bi XXX	R XXX*	9	XXXX 5.135.400/	Bi XXX	R XXX	1
	- 450	>270 - 360	9	XXXX	4.180.400/	Bi XXX	R XXX**	9	XXXX 5.180.400/	Bi XXX	R XXX	2
	>450-550	45 - 100	9	XXXX	4.45.500/	Bi XXX	R XXX	not necessary				
	>450-550	>100 - 180	9	XXXX	4.90.500/	Bi XXX	R XXX	not necessary				
	>450-550	>180 - 270	9	XXXX	4.135.500/	Bi XXX	R XXX*	9	XXXX 5.135.500/	Bi XXX	R XXX	1
	>450-550	>270 - 360	9	XXXX	4.180.500/	Bi XXX	R XXX**	9	XXXX 5.180.500/	Bi XXX	R XXX	2
	>550-650	45 - 100	9	XXXX	4.45.600/	Bi XXX	R XXX	not necessary				
	>550-650	>100 - 180	9	XXXX	4.90.600/	Bi XXX	R XXX	not necessary				
>550-650	>180 - 270	9	XXXX	4.135.600/	Bi XXX	R XXX*	9	XXXX 5.135.600/	Bi XXX	R XXX	1	
>550-650	>270 - 360	9	XXXX	4.180.600/	Bi XXX	R XXX**	9	XXXX 5.180.600/	Bi XXX	R XXX	2	
>650	>360	Ask us, we will be pleased to help you.										

Supplement Part No. with required Series (2208, 2808, 3808 oder 4008), value Bi, and appropriate value of the required radius R ► 9|4008|.5.180.600/|06|.250

*These troughs feature one support for the upper run

**These troughs feature two supports for the upper run

Support for the upper run (as of 180° rotation angle)

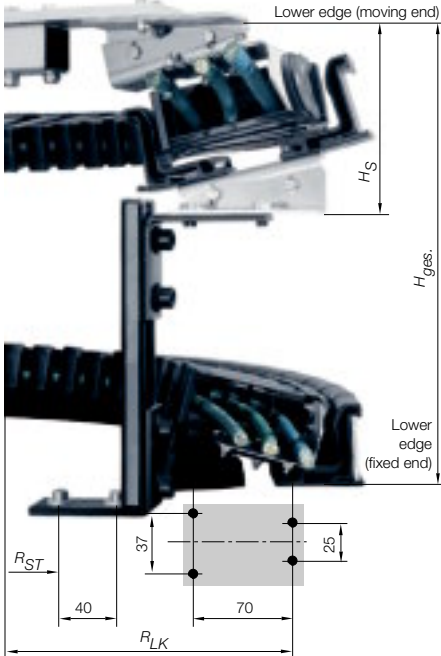

The guide trough must be mounted at the fixed end of the TwisterChain® as shown by the drilling template. The following bolted connections are permitted:

- Bolt hole: 4 x Ø 6,6 - 7 mm
- Mounting only with bolts: 4 x bolt M6

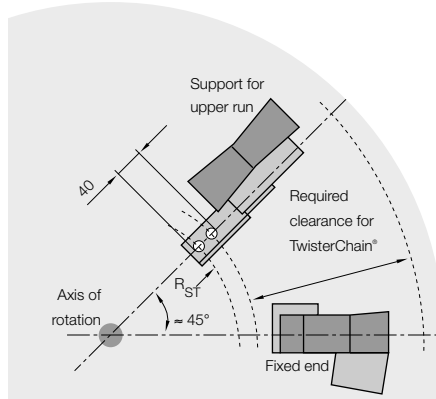

Mounting position for one support

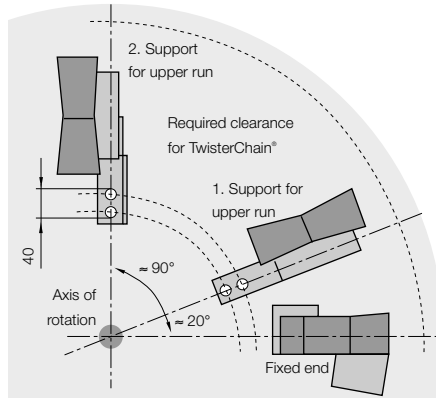

Mounting position for two supports

Installation Dimensions

Series	R _{LK} [mm]	H _S [mm]	H _{tot} [mm] for bending radius										Part No. guide trough	R _{ST} [mm]		
			R055	R063	R075	R100	R125	R150	R175	R200	R250	R300			R400	
2208...300	265	130	195	211	235	285	335	385	-	-	-	-	-	-	92208...300	145
2808...400	360	146	-	-	-	290	340	390	440	490	590	-	-	-	92808...400	192,5
3808...400	360	156	-	-	-	300	350	400	-	500	600	-	-	-	93808...400	192,5
2808...500	460	146	-	-	-	300	350	400	450	500	600	-	-	-	92808...500	292,5
3808...500	460	156	-	-	-	310	360	410	-	510	610	-	-	-	93808...500	292,5
2808...600	560	146	-	-	-	305	355	405	455	505	605	-	-	-	92808...600	392,5
3808...600	560	156	-	-	-	315	365	415	-	515	615	-	-	-	93808...600	392,5
4008...650	610	176	-	-	-	-	-	432	-	532	632	732	932	-	94008...650	442,5
4008...750	710	176	-	-	-	-	-	432	-	532	632	732	932	-	94008...750	542,5

TwisterChain®-System
Inner height: 28-56 mm

Phone +49- (0) 22 03-96 49-800
Fax +49- (0) 22 03-96 49-222



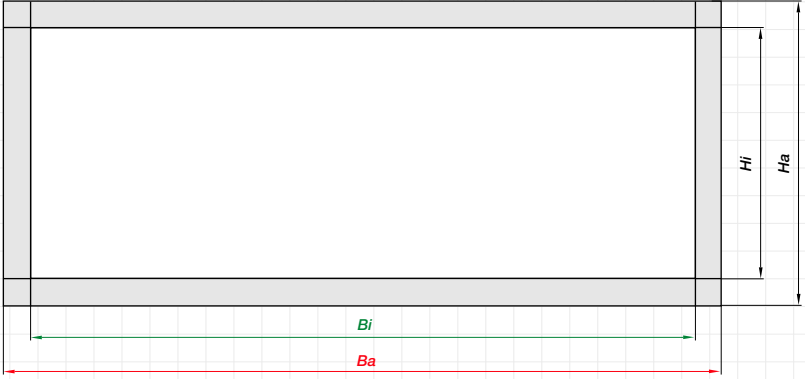

Calculation assistance

This calculation sheet should help you to select the right igus® TwisterChain® System for your application.
Rotation angle [°].....

Rotation angle

Please sketch the cable and hose layout within the chain.

Note: To find the correct Series, refer to the thickest cable diameter, plus cable clearance of approx. 20% of the chain interior.

TwisterChain® Series 2208 2808 3808 4008

Existing installation space

X_1 max..... X_2 max..... H_f max.....

E-Chain® data

Outer radius AR Inner radius IR Bending radius R

Guide trough

yes no

Part No. trough

9 _ . _ . _ . _ . _ . / _ . _ . _ .

Supporting structure necessary

yes no

The guide trough part number includes all the necessary elements for proper operation. The rotation angle is dependent upon support for the upper run and should be assembled on-site. If on-site assembly is not possible, we will deliver a supporting structure which can be assembled on the floor and is based on the height of the lower trough run. If necessary, we will design a supporting structure specially adapted to your installation!

Date:	Phone: +49- (0) 22 03 96 49 - 800 Fax: +49- (0) 22 03 96 49 - 222
From:	To: igus® GmbH Technical Sales Energy Chain Systems® P.O. Box 90 61 23 51147 Spicher Str. 1a
Phone:	
Fax:	

Please supply us with your application data. We will then send you a full analysis with cable/layout suggestion and a quotation immediately. Please consult igus® should you have any questions..

Individual components

TwisterChain®
 Chainflex® high-flex cables
 Guide Trough
 Preassembled

Filling - TwisterChain®

Number	Type	Ø [mm]	Weight [kg/m]	Permitted bending radius R [mm]

Dimensions

X_1 [mm]
 X_2 [mm]
 H_F [mm]
 Rotation angle α^* [°]

* On machine elements which move to the left and to the right following a circular path, the rotation angle can be determined by adding the two angles.

Operating data

Rotations/day
 Days/year
 Speed [°/s]
 Acceleration [°/s²]

Environment

Temperature [°C]

Moisture yes no

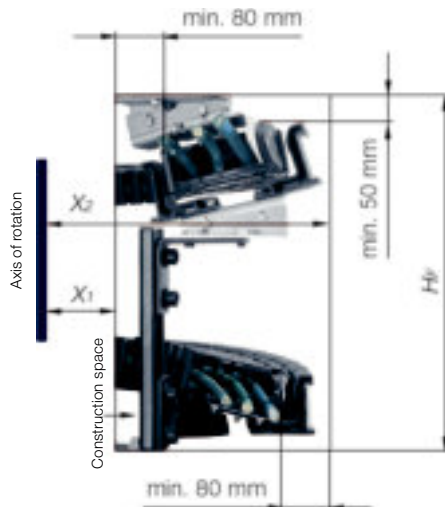

TwisterChain®-System
Inner height: 28-56 mm

Phone +49- (0) 22 03-96 49-800
Fax +49- (0) 22 03-96 49-222

igus® GmbH
51 147 Cologne

Internet: www.igus.eu
E-mail: info@igus.de

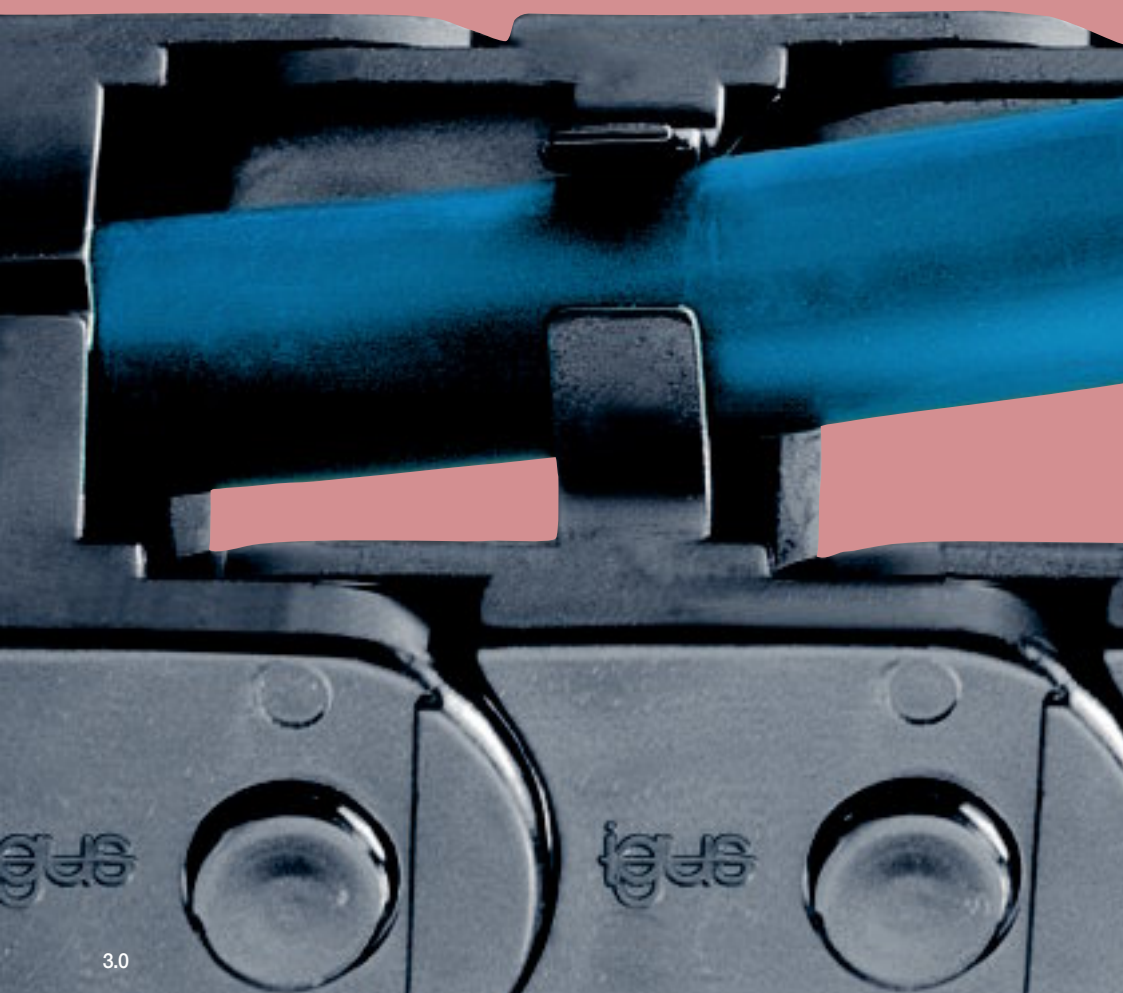

Easy Chain[®]

CHAINFLEX[®]

Easy Chain® - easy to fill and very price attractive

Easy Chains® are available with exterior (E) press fit access, as well as interior (Z) access. The assembly time reductions are a primary reason to choose Easy Chains®. Their material, igumid NB, presents more application reasons: Optimal elasticity, UL94-V2 classification and excellent cleanroom qualities. Their one-piece design keeps the Easy Chain® very price-effective

Typical industries and applications

- General machinery
- Cleanroom applications
- Electronic apparatus
- Office equipment
- Vending machines
- Packaging machines





Machinery of all kinds feature igus® Easy Chains® - reduces assembly times



Clean room test acc. to Fraunhofer Institute IPA

Standard material - ISO Class 2 acc. to ISO 14644-1

Speed: $v = 1,0 \text{ m/s}$ and $a = 2,0 \text{ m/s}$ - Series E14.3.038



Easy Chain® with electric conductible material igumid ESD for ESD/ATEX applications upon request.
Delivery time: 3-5 days



UL94-V2 classifications



With Easy Chain® rotary and torsional motions are possible

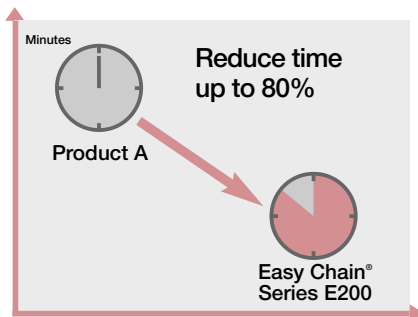

Assembly time: Insert of 2 cables Ø 6 and 10 mm.

We can present you with more details about this and other tests

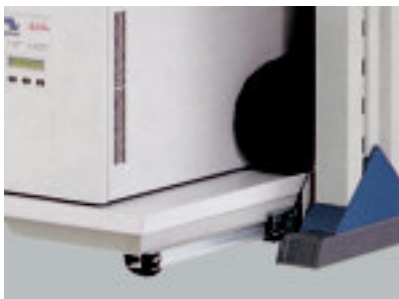

Easy Chain® Series E14 on server unit, removable for maintenance purposes Cleanroom Class 2 ISO is standard



Easy Chain® on adjustable office furniture with UL94 - V2 Classification

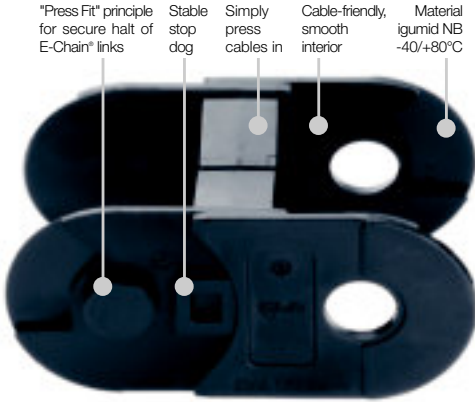

"Press Fit" principle for secure halt of E-Chain® links
 Stable stop dog
 Simply press cables in
 Cable-friendly, smooth interior
 Material igumid NB -40/+80°C

Easy Chain®: "E" and "Z" makes "Easy"

- Easy to fill from the inner radius (Version "Z") or outer (exterior) radius (Version "E")
- Fast cable accessibility without opening and closing lids
- Easy to lengthen and shorten at any point
- Low price with one-piece design
- Dirt-repellent, contoured exterior
- Mounting brackets available with integrated strain relief
- Limited torsion tolerance
- Available with interior separation (some types)
- Flammability rating UL94-V2
- Suitable for clean-room applications
- You can find more technical data about the material, chemical resistance, temperatures ► **chapter design, from page 1.38**

Selection table

Series	Inner height <i>hi</i> [mm]	Inner width <i>Bi</i> [mm]	Outer width <i>Ba</i> [mm]	Outer height <i>ha</i> [mm]	Bending radius <i>R</i> [mm]	Unsupported length max. [m]	Page
E03	5	5 - 10	8,7 - 13,7	8	10 - 28	0,40	3.6
E04	7	7	13	10	15 - 48	0,55	3.10
E045-Z045	9,4	10 - 27	16 - 37	12,5	18 - 38	0,40	3.14
E06-Z06	10,5 / 10,7	10 - 20	16,5 - 26,5	15	18 - 38	0,55	3.20
E065	11,3	16 - 36	24,8 - 49,3	15	18 - 38	0,60	3.24
E08-Z08	14,6 / 14,7	10 - 50	18,2 - 58,2	19,3	28 - 48	1,00	3.28
E14-Z14	19	15 - 50	27 - 62	25	28 - 125	0,65	3.32
E200-Z200	24,3	37 - 57	74,4 - 120,4	35	55 - 200	1,75	3.36
E16-Z16	32	23 - 100	37,5 - 115,3	39	40 - 100	1,00	3.42
E26-Z26	36,5 / 37,1	47 - 75	92 - 167	50	63 - 250	2,00	3.46
E300-Z300	48,5	46 - 75	95 - 170	64	75 - 300	2,25	3.52

Quick assembly with ESD!

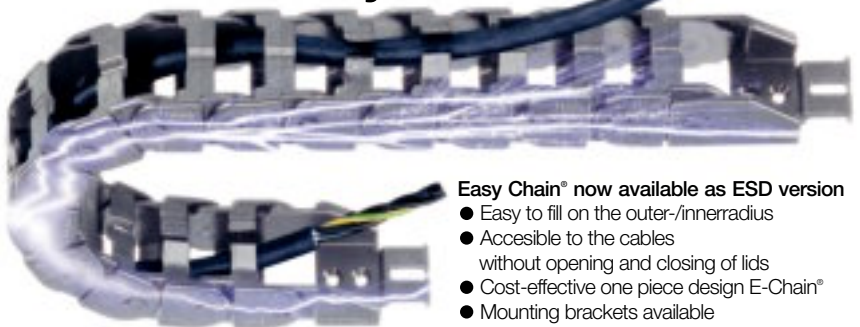

Easy Chain® now available as ESD version

- Easy to fill on the outer-/inner radius
- Accessible to the cables without opening and closing of lids
- Cost-effective one piece design E-Chain®
- Mounting brackets available

More information ► www.igus.eu/esd

Assembling | Separating | Filling | Series E03 · E04 · E/Z045



1 Twist and click or twist and divide



2 Press in cable

Assembling | Series E/Z06 · E065 · E/Z08 · E/Z14 · E/Z200 · E/Z16 · E/Z26 · E/Z300



1 Push and click...



2 Snap in pin

Separating | Series E/Z06 · E065 · E/Z08 · E/Z14 · E/Z200 · E/Z16 · E/Z26 · E/Z300



3 Release side link



4 Twist and pull apart

Filling | Series E/Z06 · E065 · E/Z08 · E/Z14 · E/Z200 · E/Z16 · E/Z26 · E/Z300



5 Press in cable



6 Pull out cable





Price index



IPA Qualification Certificate:
Air Cleanless Class ISO Class 2
(at $v = 1$ m/s) upon request



UL94-V2 classifications



Torsional
motion possible



Smallest inner heights 5 mm:
Series E03 Easy Chain®



Just push the cables with your thumb
into the E-Chain® - and it's ready



When to use the Series E03:

- If filling is required without opening and closing lids
- If price is an issue
- If quiet operation is required



When not to use it:

- Applications with very high loads and long unsupported lengths
 - ▶ Series 04 E2 micro, page 5.14
- If a E-Chain® is needed, which is not to open
 - ▶ Series 03 E2 micro, page 5.10

- 1 igus® smallest E-Chain® - interior dimensions 5 x 5 mm
- 2 Very easy to fill - ideal for harnessed cable assemblies, without opening and closing lids
- 3 Mounting bracket with integrated strain relief
- 4 Small pitch for low-noise, smooth operation
- 5 Very light weight - ideal for low fill weight
- 6 For smallest bending radii Chainflex® CF98/CF99 - 4 x d!
- 7 Low price
- 8 The patented push-button principle holds the links together



Adapter plate
for rapid installation



Order example complete E-Chain®

Please indicate chain-lengths or number of links Example: 1 m or 100 links

1 m E03.05.010.0

E-Chain®

1 set E03.05.12Z

Mounting bracket



Unsupported length

FL_G = with straight upper run

FL_B = with permitted sag

Further information ► **Design, page 1.12**

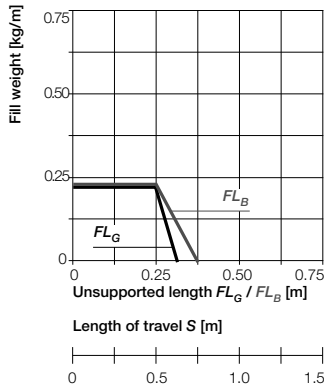
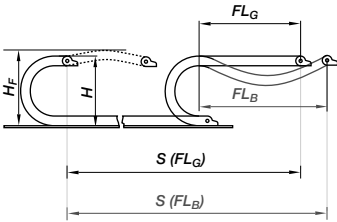

- S = Length of travel
- R = Bending radius
- H = Nominal clearance height
- H_F = Required clearance height
- D = Overlength E-Chain® radius in final position
- $K = \pi \cdot R + \text{"safety"}$

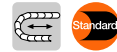
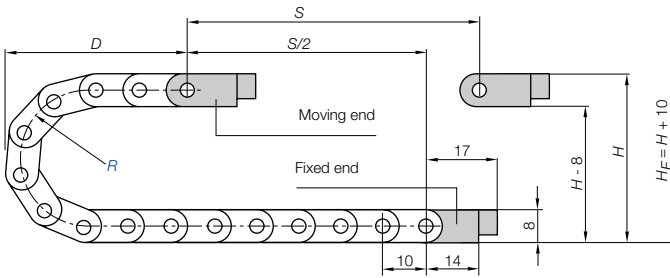

Short travels - unsupported

Unsupported E-Chains® feature positive camber over short travels. This must be accounted for when specifying the clearance height H_F . Please consult igus® if space is particularly restricted.

Pitch = 10 mm/link Links/m = 100 (1.000 mm) Chain length = $S/2 + K$

R	010	012	015	018	028
H	30	34	40	46	66
D	25	27	30	33	43
K	55	60	70	80	110

The required clearance height:
 $H_F = H + 10$ mm
 (with 0,1 kg/m fill weight)



Easy Chain®
 Inner height: 5 mm

Phone +49- (0) 22 03-96 49-800
 Fax +49- (0) 22 03-96 49-222



Speed / acceleration FL_G	max. 20 [m/s] / max. 200 [m/s²]
Speed / acceleration FL_B	max. 3 [m/s] / max. 6 [m/s²]
Gliding speed / acceleration (maximum)	max. 3 [m/s] / max. 10 [m/s²]
Material (E-Chain®)- permitted temperature °C	igumid NB / -40° up to +80° C
Material (mounting brackets)* - permitted temperature °C	igumid G / -40° up to +120° C
Flammability class (E-Chain®), igumid NB	VDE 0304 IIC UL94 V2
Flammability class (mounting brackets), igumid G*	VDE 0304 IIC UL94 HB

*Available in igumid NB upon request, please consult igus® for delivery time

Technical Data



Details of material properties
 ► page 1.38



► page 3.5

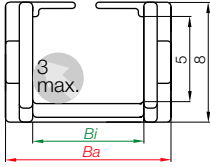

Part No. structure

E03.	05.	010.	0
			Color black
			Bending radius
			Width
			Series

Series E03 - split crossbar along the outer radius

Part No.	Bi [mm]	Ba [mm]	R [mm]	Bending radii				Weight [kg/m]
E03.05.□.0	5	8,7	010	012	015	018	028	≈ 0,03
E03.07.□.0	7	10,7	010	012	015	018	028	≈ 0,04
E03.10.□.0	10	13,7	010	012	015	018	028	≈ 0,05

Ba: pin dimension approx. 0,1 - 0,3 mm wider!

Supplement Part No. with required radius. Example: E03.05.□010□.0

0 = standard color, other colors ▶ page 1.39 · Pitch = 10 mm/link - Links/m = 100





Polymer, one-piece

- One-piece mounting bracket
- Corrosion-resistant
- Available preassembled
- Inner and outer attachment possible
- Adapter plate for rapid installation

Moving end with bore
(outer link) 03...1Z

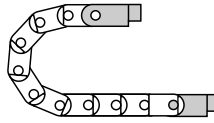

03...2Z Fixed end
with pin (inner link)

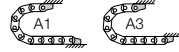

Possible installation conditions for assembled mounting brackets ▶ Order example "preassembled" below

03...1Z
Moving end

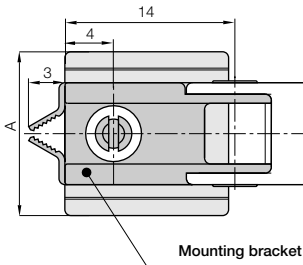

03...2Z
Fixed end

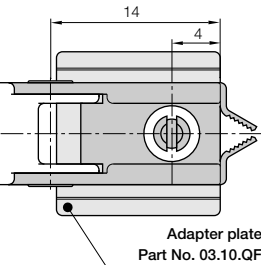

Dimensions and order configurations

For E-Chain®	Part No. full set	Dim. A [mm]
E03.05. ▶	03.05. 12Z	8,7
E03.07. ▶	03.07. 12Z	10,7
E03.10. ▶	03.10. 12Z	13,7

For the preassembled mode please add the index A1 or A3 e.g. 03.05. 12Z A1

03.10.QF = Adapter plate for all sizes

The adapter has broken edges, so that it can be adapted to the respective chain width. It is not absolutely necessary for attaching the mounting brackets. The mounting brackets can also be screwed on without the adapter plate.

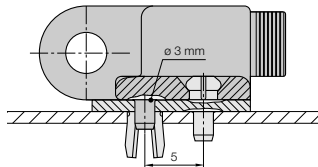

Part No. structure

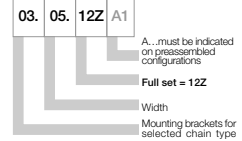

Full set, for both ends:

03. | 05. | 12Z

Single-part order:

03. | 05. | 1Z

Mounting bracket with bore

03. | 05. | 2Z

Mounting bracket with pin



Adapter plate for rapid installation upon request Part No. 03.10.QF

Additional Features

Phone +49- (0) 22 03-96 49-800
Fax +49- (0) 22 03-96 49-222



● ● ● Price index



IPA Qualification Certificate:
Air Cleanless Class ISO Class 2
(at v = 1 m/s) upon request



UL94-V2
classifications



Torsional
motion possible



Special equipment:
Electrically conductive ESD/ATEX
version upon request



Just push the cables with your thumb
into the E-Chain® - and it's ready



When to use the Series E04:

- If filling is required without opening and closing lids
- If price is an issue
- If quiet operation is required



When not to use it:

- For applications with very high loads and long unsupported travel lengths
 - ▶ Series 06 E2 micro, page 5.26
- If a E-Chain® is needed, which is not to open
 - ▶ Series 06 E2 micro, page 5.26

- 1 Very easy to fill - ideal for harnessed cable assemblies
- 2 Small pitch for low-noise, smooth operation
- 3 For high acceleration
- 4 Limited torsion tolerance
- 5 Cable -friendly smooth interior
- 6 Mounting brackets available
- 7 The patented push-button principle holds the links together



Special solution -
opening gap 0,8 mm
Part No. E04.07.015.S



Order example complete E-Chain®

Please indicate chain-lengths or number of links Example: 1 m or 60 links

1 m E04.07.038.0



E-Chain®

1 set 040.07.12



Mounting bracket



Unsupported length

FL_G = with straight upper run

FL_B = with permitted sag

Further information ► **Design, page 1.12**

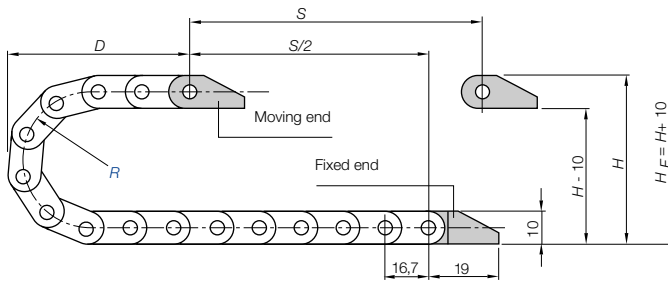
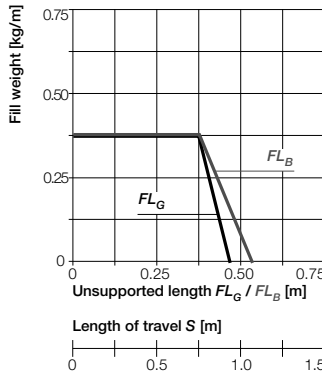
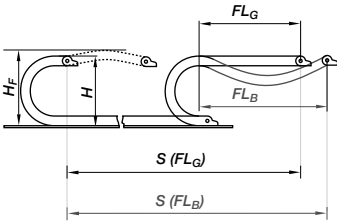

Pitch = 16,7 mm/link Links/m = 60 (1.002 mm) Chain length = $S/2 + K$

R	015	018	028	038	048
H	42	48	68	88	108
D	37	40	50	60	70
K	80	90	125	155	185

- S = Length of travel
- R = Bending radius
- H = Nominal clearance height
- H_F = Required clearance height
- D = Overlength E-Chain® radius in final position
- K = $\pi \cdot R + \text{"safety"}$

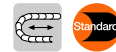

Short travels - unsupported

Unsupported E-Chains® feature positive camber over short travels. This must be accounted for when specifying the clearance height H_F . Please consult igus® if space is particularly restricted.

The required clearance height:
 $H_F = H + 10$ mm
 (with 0,1 kg/m fill weight)

Speed / acceleration FL_G	max. 20 [m/s] / max. 200 [m/s ²]
Speed / acceleration FL_B	max. 3 [m/s] / max. 6 [m/s ²]
Gliding speed / acceleration (maximum)	max. 3 [m/s] / max. 10 [m/s ²]
Material (E-Chain®)- permitted temperature °C	igumid NB / -40° up to +80° C
Material (mounting brackets)* - permitted temperature °C	igumid G / -40° up to +120° C
Flammability class (E-Chain®), igumid NB	VDE 0304 IIC UL94 V2
Flammability class (mounting brackets), igumid G*	VDE 0304 IIC UL94 HB

*Available in igumid NB upon request, please consult igus® for delivery time

Technical Data



Details of material properties
 ► page 1.38



Easy Chain®
 Inner height: 7 mm

Phone +49- (0) 22 03-96 49-800
 Fax +49- (0) 22 03-96 49-222



► page 3.5

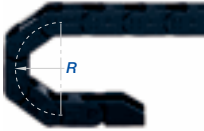
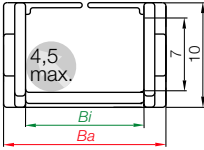

Part No. structure

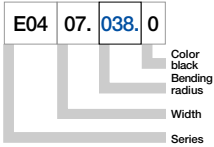

Series E04 - split crossbar along the outer radius

Part No.	Bi [mm]	Ba [mm]	R [mm]	Bending radii					Weight [kg/m]
E04.07. <input type="text"/> .0	7	13	015	018	028	038	048	≈ 0,08	

Ba: pin dimension approx. 0,1 - 0,3 mm wider!

Supplement Part No. with required radius. Example: E04.07. .0

0 = standard color, other colors ▶ page 1.39 · Pitch = 16,7 mm/link - Links/m = 60





Polymer, one-piece

- One-piece mounting bracket
- Corrosion-resistant
- Available preassembled

Moving end with bore
(outer link) 040...1 (PZ)

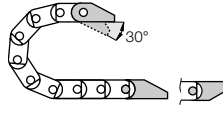

040...2(PZ) Fixed end
with pin (inner link)

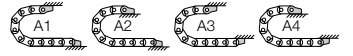

Possible installation conditions for assembled mounting brackets ▶ Order example "preassembled" below

040...1 (PZ)
Moving end

040...2(PZ)
Fixed end

Dimensions and order configurations

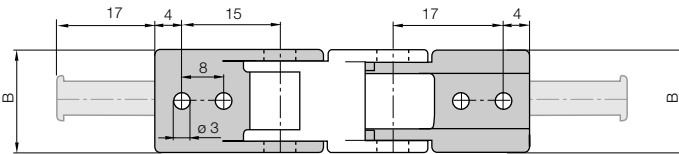

For E-Chain®	Part No. full set with tiewrap plate	Part No. full set without tiewrap plate	Number of teeth	Dim. B [mm]
E04.07. ▶	040.07. 12 PZ	040.07. 12	1	12

Part No. structure

040.07. 12 PZ A1

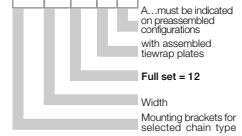

Full set, for both ends:

040.07. 12 PZ +tiewrap plate

Single-part order:

040.07. 1 PZ +tiewrap plate

Mounting bracket with bore

040.07. 2 PZ +tiewrap plate

Mounting bracket with pin

For the preassembled mode please add the index A1 ... A4 e.g. 040.07. 12 PZ A1



Quicksnap - the complete, detachable mounting unit, available upon request



Quickfix - mounting bracket with dowel, available upon request

Additional Features



▶ page 3.5

Phone +49- (0) 22 03-96 49-800
Fax +49- (0) 22 03-96 49-222



Price index



IPA Qualification Certificate:
Air Cleanless Class ISO Class 2
(at v = 1 m/s) upon request



UL94-V2
classifications



Torsional
motion possible



Special equipment:
Electrically conductive ESD/ATEX
version upon request



Just push the cables with your thumb
into the E-Chain® - and it's ready



When to use the Series E045/Z045:

- If filling is required without opening and closing lids
- If a very small pitch is required



When not to use it:

- For applications with very high loads and long unsupported travel lengths
 - ▶ Series 06 E2 micro, page 5.26
- If smooth operation is required
 - ▶ Series 045 E2 micro, page 5.18
- If high stability is required
 - ▶ Series 06 E2 micro, page 5.26

- ① Very easy to fill
- ② Small pitch for low-noise, smooth operation
- ③ Limited torsion tolerance
- ④ The patented push-button principle holds the links together
- ⑤ Cable-friendly interior
- ⑥ "E" Series features split crossbar along the outer radius
- ⑦ "Z" Series features split crossbar along the inner radius
- ⑧ Mounting bracket available
- ⑨ 1-, 2- or 3-chamber system available

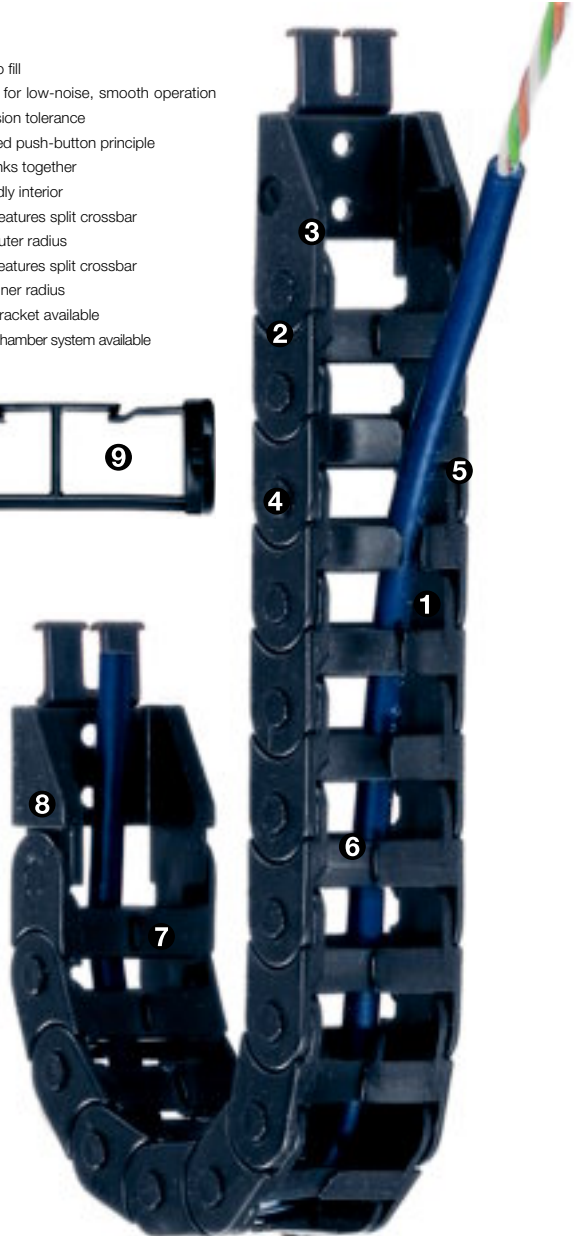

Order example complete E-Chain®

Please indicate chain-lengths or number of links Example: 1 m or 77 links

1 m E045.16.038.0



E-Chain®

1 set 0450.16.12



Mounting bracket



Unsupported length

FL_G = with straight upper run

FL_B = with permitted sag

Further information ► **Design, page 1.12**

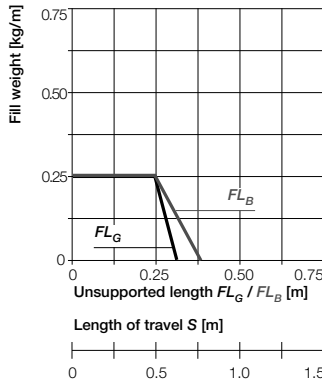
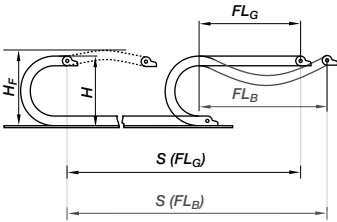

- S = Length of travel
- R = Bending radius
- H = Nominal clearance height
- H_F = Required clearance height
- D = Overlength E-Chain® radius in final position
- $K = \pi \cdot R + \text{"safety"}$

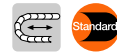
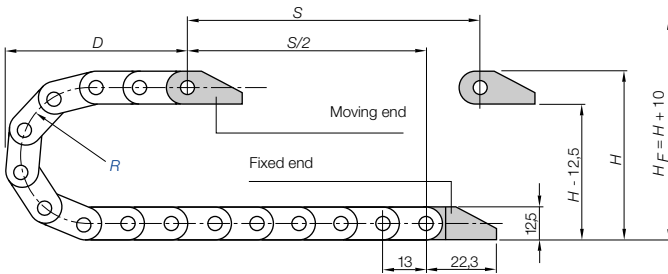

Short travels - unsupported

Unsupported E-Chains® feature positive camber over short travels. This must be accounted for when specifying the clearance height H_F . Please consult igus® if space is particularly restricted.

Pitch = 13 mm/link Links/m = 77 (1.001 mm) Chain length = $S/2 + K$

R	018	028	038
H	50	70	90
D	40	50	60
K	95	120	145

The required clearance height:
 $H_F = H + 10$ mm
(with 0,1 kg/m fill weight)

Speed / acceleration FL_G	max. 20 [m/s] / max. 200 [m/s ²]
Speed / acceleration FL_B	max. 3 [m/s] / max. 6 [m/s ²]
Gliding speed / acceleration (maximum)	max. 3 [m/s] / max. 10 [m/s ²]
Material (E-Chain®)- permitted temperature °C	igumid NB / -40° up to +80° C
Material (mounting brackets)* - permitted temperature °C	igumid G / -40° up to +120° C
Flammability class (E-Chain®), igumid NB	VDE 0304 IIC UL94 V2
Flammability class (mounting brackets), igumid G*	VDE 0304 IIC UL94 HB

*Available in igumid NB upon request, please consult igus® for delivery time

Technical Data



Details of material properties
► page 1.38



Easy Chain®
Inner height: 9,4 mm

Phone +49- (0) 22 03-96 49-800
Fax +49- (0) 22 03-96 49-222



► page 3.5

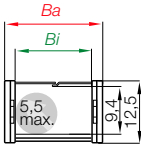

Series E045 - split crossbar along the outer radius

Part No.	B_i [mm]	B_a [mm]	R [mm]	Bending radii	Weight [kg/m]
E045.10. <input type="text"/> .0	10	16	<input type="text" value="018"/> <input type="text" value="028"/> <input type="text" value="038"/>	≈ 0,09	
E045.16. <input type="text"/> .0	16	23	<input type="text" value="018"/> <input type="text" value="028"/> <input type="text" value="038"/>	≈ 0,11	

B_a : pin dimension approx. 0,1 - 0,3 mm wider!

Supplement Part No. with required radius. Example: E045.16. .0

0 = standard color, other colors ▶ page 1.39 · Pitch = 13 mm/link - Links/m = 77

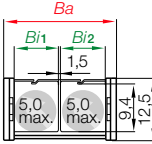

Series E045 - split crossbar along the outer radius with 2-chamber system

Part No.	B_i [mm]	B_a [mm]	R [mm]	Bending radii	Weight [kg/m]
E045.2/7. <input type="text"/> .0	7 / 7	23	<input type="text" value="018"/> <input type="text" value="028"/> <input type="text" value="038"/>	≈ 0,13	
E045.2/9. <input type="text"/> .0	9 / 9	27	<input type="text" value="018"/> <input type="text" value="028"/> <input type="text" value="038"/>	≈ 0,14	

B_a : pin dimension approx. 0,1 - 0,3 mm wider!

Supplement Part No. with required radius. Example: E045.2/9. .0

0 = standard color, other colors ▶ page 1.39 · Pitch = 13 mm/link - Links/m = 77

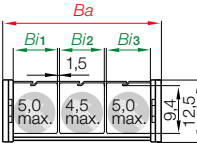

Series E045 - split crossbar along the outer radius with 3-chamber system

Part No.	B_i [mm]	B_a [mm]	R [mm]	Bending radii	Weight [kg/m]
E045.3/9. <input type="text"/> .0	9 / 9 / 9	37	<input type="text" value="018"/> <input type="text" value="028"/> <input type="text" value="038"/>	≈ 0,17	

B_a : pin dimension approx. 0,1 - 0,3 mm wider!

Supplement Part No. with required radius. Example: E045.3/9. .0

0 = standard color, other colors ▶ page 1.39 · Pitch = 13 mm/link - Links/m = 77

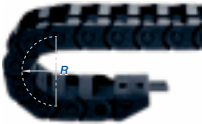

Part No. structure

E045. 16. . 0



Phone +49- (0) 22 03-96 49-800
Fax +49- (0) 22 03-96 49-222

igus® GmbH
51147 Cologne

Internet: www.igus.eu
E-mail: info@igus.de

Series Z045 - split crossbar along the inner radius

Part No.	<i>B_i</i> [mm]	<i>B_a</i> [mm]	<i>R</i> [mm]	Bending radii	Weight [kg/m]
Z045.16.□.0	16	23	018	028 038	≈ 0,11

B_a: pin dimension approx. 0,1 - 0,3 mm wider!

Supplement Part No. with required radius. Example: Z045.16.038.0

0 = standard color, other colors ► page 1.39 · Pitch = 13 mm/link - Links/m = 77

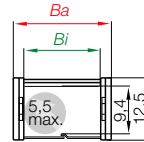

Series Z045 - split crossbar along the inner radius with 2-chamber system

Part No.	<i>B_i</i> [mm]	<i>B_a</i> [mm]	<i>R</i> [mm]	Bending radii	Weight [kg/m]
Z045.2/7.□.0	7 / 7	23	018	028 038	≈ 0,13

B_a: pin dimension approx. 0,1 - 0,3 mm wider!

Supplement Part No. with required radius. Example: Z045.2/7.038.0

0 = standard color, other colors ► page 1.39 · Pitch = 13 mm/link - Links/m = 77

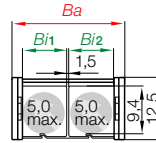

Part No. structure

Z045. 16. 038. 0



Easy Chain®
Inner height: 9,4 mm

Phone +49- (0) 22 03-96 49-800
Fax +49- (0) 22 03-96 49-222





Possible installation conditions for assembled mounting brackets ▶ Order example "preassembled" below



Polymer, one-piece

- One-piece mounting bracket
- Corrosion-resistant
- Available preassembled

Moving end with bore
(outer link) 045...1

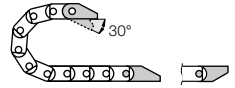

045...2 E03...2Z Fixed end
with pin (inner link)

Dimensions and order configurations

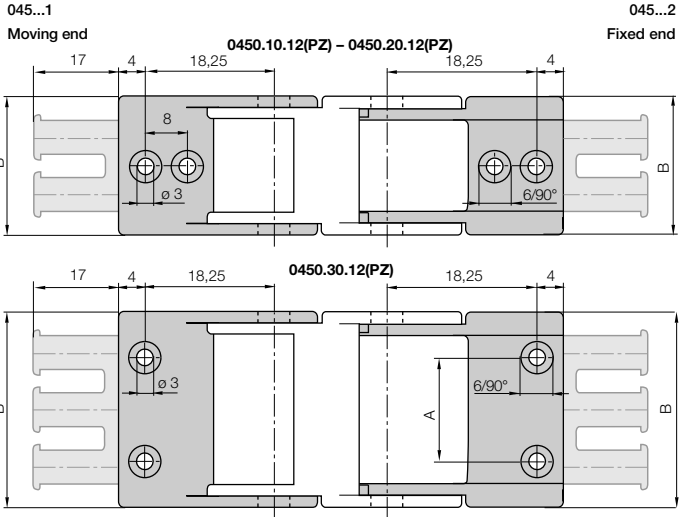

Part No. structure

0450. 10. 12 PZ A2

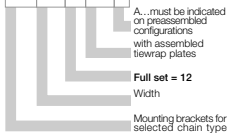

Full set, for both ends:

0450.10.12 PZ +tiwrap plate

Single-part order:

0450.10.1 PZ +tiwrap plate

Mounting bracket with bore

0450.10.2 PZ +tiwrap plate

Mounting bracket with pin

For E-Chain®	Part No. full set with tiwrap plate	Part No. full set without tiwrap plate	Number of teeth	Dim. A [mm]	Dim. B [mm]
E045.10.	▶ 0450.10.12 PZ	0450.10.12	1	–	16
E/Z045.16.	▶ 0450.16.12 PZ	0450.16.12	2	–	22
E/Z045.2/7.	▶ 0450.16.12 PZ	0450.16.12	2	–	22
E045.2/9.	▶ 0450.20.12 PZ	0450.20.12	2	–	26
E045.3/9.	▶ 0450.30.12 PZ	0450.30.12	3	22	36

For the preassembled mode please add the index A2 or A4 e.g. 0450.20.12 PZ A2

Mounting brackets with tiwrap plate are available upon request. Time of delivery approx. 6-8 weeks after order. Mounting brackets without tiwrap plate are available from stock.

Additional Features



Quicksnap - the complete, detachable mounting unit, available upon request



Quickfix - mounting bracket with dowel, available upon request

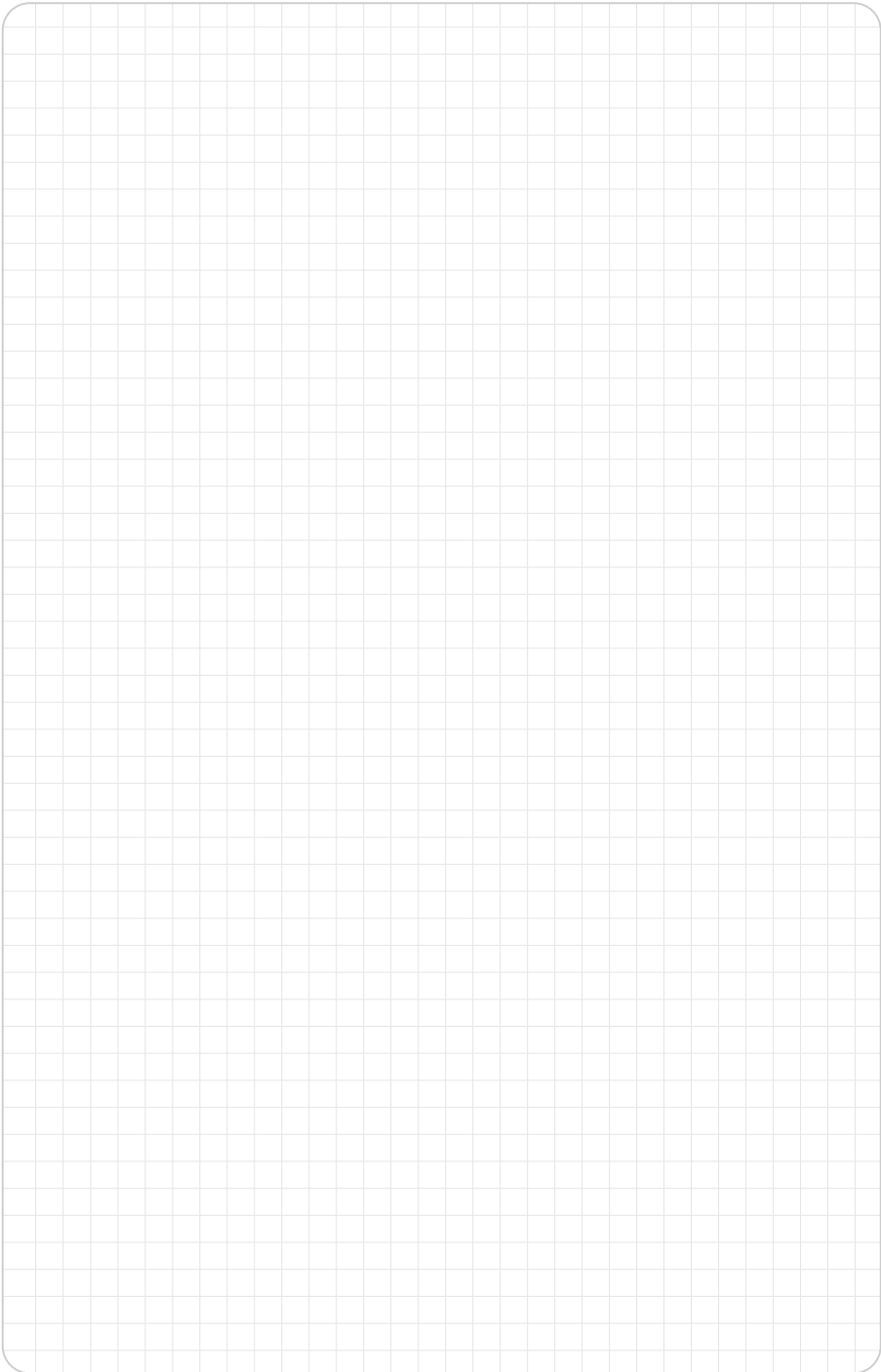

Easy Chain®
Inner height: 9,4 mm

Phone +49- (0) 22 03-96 49-800
Fax +49- (0) 22 03-96 49-222



Price index



IPA Qualification Certificate:
Air Cleanless Class ISO Class 2
(at v = 1 m/s) upon request



UL94-V2
classifications



Torsional
motion possible



Special equipment:
Electrically conductive ESD/ATEX
version upon request



Just push the cables with your thumb
into the E-Chain® - and it's ready



When to use the Series E06/Z06:

- If filling is required without opening and closing lids
- If price is an issue
- If quiet operation is required



When not to use it:

- For applications with very high loads and long unsupported travel lengths
 - ▶ Series 06 E2 micro, page 5.26
- "Z" Series is unsuitable for gliding applications
 - ▶ Series 07 Zipper, page 4.10

- ① Very easy to fill - ideal for harnessed cable assemblies
- ② Small pitch for low-noise, smooth operation
- ③ Limited torsion tolerance
- ④ Very light weight
- ⑤ The patented push-button principle holds the links together
- ⑥ Cable -friendly smooth interior
- ⑦ "E" Series features split crossbar along the outer radius
- ⑧ "Z" Series features split crossbar along the inner radius
- ⑨ Integrated strain relief option



Special solution -
opening gap 3,5 mm
Part No. E06.10.018S3



Order example complete E-Chain®

Please indicate chain-lengths or number of links **Example: 1 m or 50 links**

1 m **E06.10.038.0**



E-Chain®

1 set **060.10.12**



Mounting bracket



Unsupported length

FL_G = with straight upper run

FL_B = with permitted sag

Further information ► Design, page 1.12

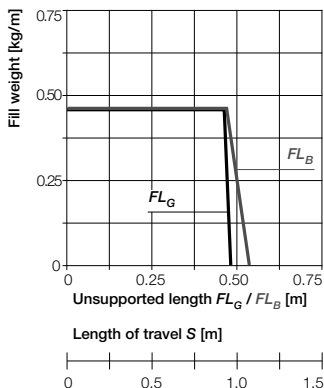
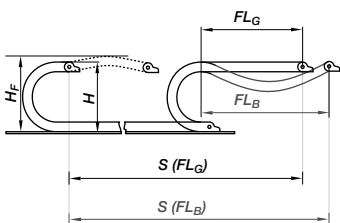

- S = Length of travel
- R = Bending radius
- H = Nominal clearance height
- H_F = Required clearance height
- D = Overlength E-Chain® radius in final position
- $K = \pi \cdot R + \text{"safety"}$

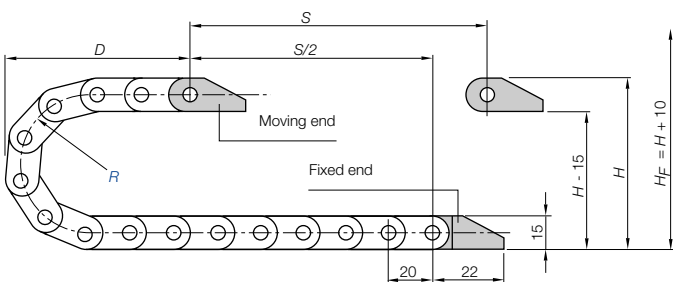

Short travels - unsupported

Unsupported E-Chains® feature positive camber over short travels. This must be accounted for when specifying the clearance height H_F . Please consult igus® if space is particularly restricted.

Pitch = 20 mm/link Links/m = 50 (1.000 mm) Chain length = $S/2 + K$

R	018	028	038
H	52	70	90
D	40	50	60
K	95	120	145

The required clearance height:
 $H_F = H + 10$ mm
(with 0,2 kg/m fill weight)



Speed / acceleration FL_G	max. 20 [m/s] / max. 200 [m/s²]
Speed / acceleration FL_B	max. 3 [m/s] / max. 6 [m/s²]
Gliding speed / acceleration (maximum)	max. 3 [m/s] / max. 10 [m/s²]
Material (E-Chain®)- permitted temperature °C	igumid NB / -40° up to +80° C
Material (mounting brackets)* - permitted temperature °C	igumid G / -40° up to +120° C
Flammability class (E-Chain®), igumid NB	VDE 0304 IIC UL94 V2
Flammability class (mounting brackets), igumid G*	VDE 0304 IIC UL94 HB

*Available in igumid NB upon request, please consult igus® for delivery time

Technical Data



Details of material properties
► page 1.38



► page 3.5

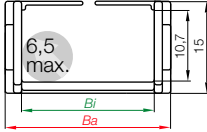

Series E06 - split crossbar along the outer radius

Part No.	Bi [mm]	Ba [mm]	R [mm]	Bending radii			Weight [kg/m]
E06.10.□.0	10	16,5	018	028	038	≈ 0,14	
E06.16.□.0	16	22,5	018	028	038	≈ 0,16	
E06.20.□.0	20	26,5	018	028	038	≈ 0,18	

Ba: pin dimension approx. 0,2 - 0,4 mm wider!

Supplement Part No. with required radius. Example: E06.10.□038□.0

0 = standard color, other colors ▶ page 1.39 · Pitch = 20 mm/link - Links/m = 50

Part No. structure

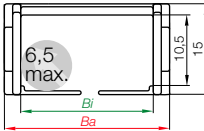
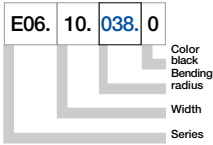

Series Z06 - split crossbar along the inner radius

Part No.	Bi [mm]	Ba [mm]	R [mm]	Bending radii			Weight [kg/m]
Z06.10.□.0	10	16,5	018	028	038	≈ 0,14	
Z06.16.□.0	16	22,5	018	028	038	≈ 0,16	
Z06.20.□.0	20	26,5	018	028	038	≈ 0,18	

Ba: pin dimension approx. 0,2 - 0,4 mm wider!

The width Bi 20 is available upon request. Time of delivery approx. 6-8 weeks after order.

Supplement Part No. with required radius. Example: Z06.10.□038□.0

0 = standard color, other colors ▶ page 1.39 · Pitch = 20 mm/link - Links/m = 50

Part No. structure

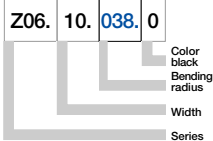



Polymer, one-piece

- One-piece mounting bracket
- Corrosion-resistant
- Available preassembled
- Inner and outer attachment possible
- Available with integrated strain relief tiewrap plates

Moving end with bore
(outer link) 060...1(PZ)

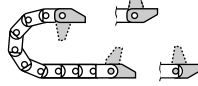

060...2(PZ) Fixed end
with pin (inner link)



Possible installation conditions for assembled mounting brackets ▶ Order example "preassembled" below

060...1(PZ)
Moving end

060...2(PZ)
Fixed end

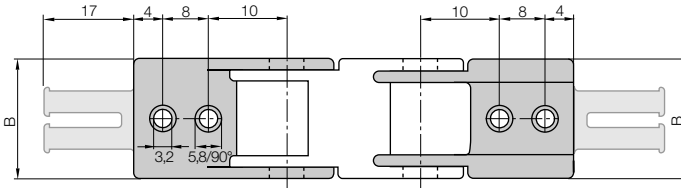

Dimensions and order configurations

Strain relief is possible on the moving end and/or the fixed end.

Part No. structure

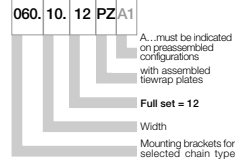

Full set, for both ends:

060.10.12.PZ +tiewrap plate

Single-part order:

060.10.1.PZ +tiewrap plate

Mounting bracket with bore

060.10.2.PZ +tiewrap plate

Mounting bracket with pin

For E-Chain®	Part No. full set with tiewrap plate	Part No. full set without tiewrap plate	Number of teeth	Dim. B [mm]
E06-Z06.10. ▶	060.10.12.PZ	060.10.12	1	16,5
E06-Z06.16. ▶	060.16.12.PZ	060.16.12	2	22,5
E06.20. ▶	060.20.12.PZ	060.20.12	2	27

For the preassembled mode please add the index A1 ... A4 e.g. 060.10.12.PZ.A1



Quicksnap - the complete, detachable mounting unit, available upon request



Quickfix - mounting bracket with dowel, available upon request

Additional Features

Phone +49- (0) 22 03-96 49-800
Fax +49- (0) 22 03-96 49-222





Price index



IPA Qualification Certificate:
Air Cleanless Class ISO Class 2
(at v = 1 m/s) upon request



UL94-V2
classifications



Torsional
motion possible



Special equipment:
Electrically conductive ESD/ATEX
version upon request



Just push the cables with your thumb
into the E-Chain® - and it's ready



When to use the Series E065:

- If filling is required without opening and closing lids
- If price is an issue
- If quiet operation is required



When not to use it:

- For applications with very high loads and long unsupported travel lengths
- Series 06 E2 micro, page 5.26

- ① Very easy to fill - ideal for harnessed cable assemblies
- ② Small pitch for low-noise, smooth operation
- ③ Limited torsion tolerance
- ④ Very light weight
- ⑤ The patented push-button principle holds the links together
- ⑥ Cable-friendly interior
- ⑦ Split crossbar along the outer radius
- ⑧ Mounting bracket with integrated strain relief
- ⑨ 1-, 2-, 3- or 4-chamber system available

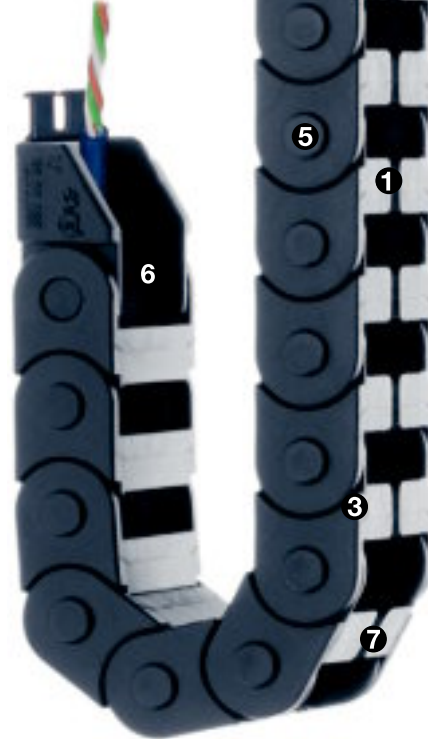

Order example complete E-Chain®

Please indicate chain-lengths or number of links **Example: 1 m or 67 links**

1 m **E065.16.018.0**



E-Chain®

1 set **0650.16.12PZ**



Mounting bracket



Unsupported length

FL_G = with straight upper run

FL_B = with permitted sag

Further information ► **Design, page 1.12**

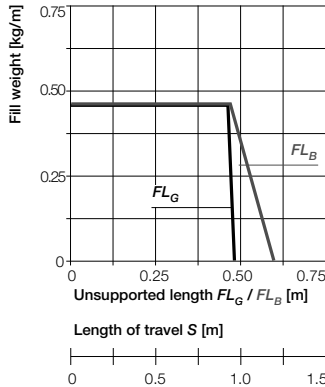
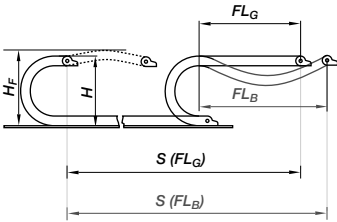

- S = Length of travel
- R = Bending radius
- H = Nominal clearance height
- H_F = Required clearance height
- D = Overlength E-Chain® radius in final position
- $K = \pi \cdot R + \text{"safety"}$

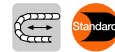
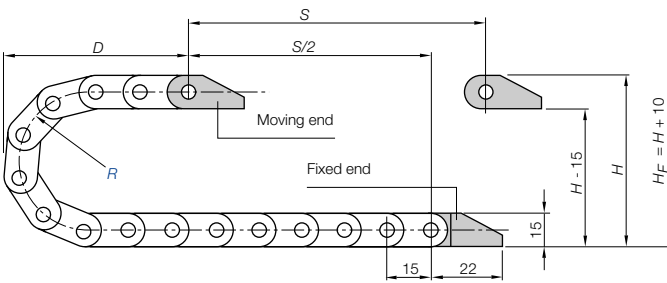

Short travels - unsupported

Unsupported E-Chains® feature positive camber over short travels. This must be accounted for when specifying the clearance height H_F . Please consult igus® if space is particularly restricted.

Pitch = 15 mm/Glied Links/m = 67 (1.005 mm) Chain length = $S/2 + K$

R	018	028	038
H	52	70	90
D	40	50	60
K	86	118	149

The required clearance height:
 $H_F = H + 10$ mm
 (with 0,2 kg/m fill weight)



Easy Chain®
 Inner height: 11,3 mm

Phone +49- (0) 22 03-96 49-800
 Fax +49- (0) 22 03-96 49-222



Speed / acceleration FL_G	max. 20 [m/s] / max. 200 [m/s²]
Speed / acceleration FL_B	max. 3 [m/s] / max. 6 [m/s²]
Gliding speed / acceleration (maximum)	max. 3 [m/s] / max. 10 [m/s²]
Material (E-Chain®)- permitted temperature °C	igumid NB / -40° up to +80° C
Material (mounting brackets)* - permitted temperature °C	igumid G / -40° up to +120° C
Flammability class (E-Chain®), igumid NB	VDE 0304 IIC UL94 V2
Flammability class (mounting brackets), igumid G*	VDE 0304 IIC UL94 HB

*Available in igumid NB upon request, please consult igus® for delivery time

Technical Data



Details of material properties
 ► page 1.38



► page 3.5



igus® E-ChainSystems®

Phone +49- (0) 22 03-96 49-800
 Fax +49- (0) 22 03-96 49-222

igus® GmbH
 51147 Cologne

Internet: www.igus.eu
 E-mail: info@igus.de

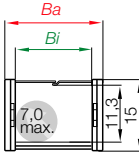

Series E065 - split crossbar along the outer radius

Part No.	Bi [mm]	Ba [mm]	R [mm] Bending radii	Weight [kg/m]
E065.16. <input type="text"/> .0	16	24,8	<input type="text" value="018"/> <input type="text" value="028"/> <input type="text" value="038"/>	≈ 0,17

Supplement Part No. with required radius. Example: E065.16. .0

0 = standard color, other colors ▶ page 1.39 · Pitch = 15 mm/link - Links/m = 67

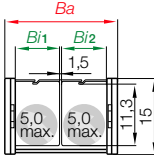

Series E065 - split crossbar along the outer radius with 2-chamber system

Part No.	Bi [mm]	Ba [mm]	R [mm] Bending radii	Weight [kg/m]
E065.2/9. <input type="text"/> .0	9 / 9	29,3	<input type="text" value="018"/> <input type="text" value="028"/> <input type="text" value="038"/>	≈ 0,19

Supplement Part No. with required radius. Example: E065.2/9. .0

0 = standard color, other colors ▶ page 1.39 · Pitch = 15 mm/link - Links/m = 67

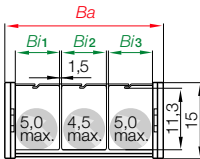

Series E065 - split crossbar along the outer radius with 3-chamber system

Part No.	Bi [mm]	Ba [mm]	R [mm] Bending radii	Weight [kg/m]
E065.3/9. <input type="text"/> .0	9 / 9 / 9	39,3	<input type="text" value="018"/> <input type="text" value="028"/> <input type="text" value="038"/>	≈ 0,22

Supplement Part No. with required radius. Example: E065.3/9. .0

0 = standard color, other colors ▶ page 1.39 · Pitch = 15 mm/link - Links/m = 67

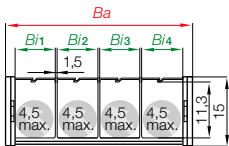

Series E065 - split crossbar along the outer radius with 4-chamber system

Part No.	Bi [mm]	Ba [mm]	R [mm] Bending radii	Weight [kg/m]
E065.4/9. <input type="text"/> .0	9 / 9 / 9 / 9	49,3	<input type="text" value="018"/> <input type="text" value="028"/> <input type="text" value="038"/>	≈ 0,25

Supplement Part No. with required radius. Example: E065.4/9. .0

0 = standard color, other colors ▶ page 1.39 · Pitch = 15 mm/link - Links/m = 67



Part No. structure

E065. 16. .0





Polymer, one-piece

- One-piece mounting bracket
- Corrosion-resistant
- Available preassembled
- Inner and outer attachment possible
- Available with integrated strain relief tiewrap plates

Moving end with bore
(outer link) 0650...1PZ

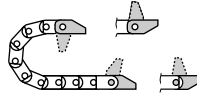

0650...2PZ Fixed end
with pin (inner link)

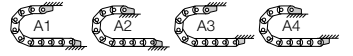

Possible installation conditions for assembled mounting brackets ▶ Order example "preassembled" below

0650...1PZ
Moving end

0650...2PZ
Fixed end

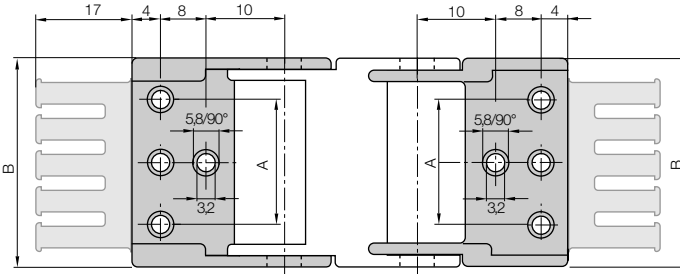

Dimensions and order configurations

Strain relief is possible on the moving end and/or the fixed end.

For E-Chain®	Part No. full set with tiewrap plate	Number of teeth	Dim. A [mm]	Dim. B [mm]
E065.16. ▶	0650.16. 12 PZ	2	-	22,5
E065.2/9. ▶	0650.2/9. 12 PZ	2	-	27
E065.3/9. ▶	0650.3/9. 12 PZ	3	22	37
E065.4/9. ▶	0650.4/9. 12 PZ	4	32	47

For the **preassembled** mode please add the index **A1** ... **A4** e. g. 0650.16. | 12 | PZ | **A1**

Part No. structure

0650. 16. 12 PZ A1

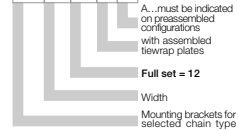

Full set, for both ends:

0650. 16. 12 | PZ | +tiewrap plate

Single-part order:

0650. 16. 1 | PZ | +tiewrap plate

Mounting bracket **with bore**

0650. 16. 2 | PZ | +tiewrap plate

Mounting bracket **with pin**



Quicksnap - the complete, detachable mounting unit, available upon request



Quickfix - mounting bracket with dowel, available upon request

Additional Features



● ● ● Price index



IPA Qualification Certificate:
Air Cleanless Class ISO Class 2
(at v = 1 m/s) upon request



UL94-V2
classifications



Torsional
motion possible



Special equipment:
Electrically conductive ESD/ATEX
version upon request



Just pull out cable by hand
- and it's ready



When to use the Series E08/Z08:

- If filling is required without opening and closing lids
- If price is an issue
- If quiet operation is required



When not to use it:

- For applications with very high loads and long unsupported travel lengths
 - ▶ Series 09 Zipper, page 4.14
- "Z" Series is unsuitable for gliding applications
 - ▶ Series 09 Zipper, page 4.14

- 1 Very easy to fill - ideal for harnessed cable assemblies
- 2 Small pitch for low-noise, smooth operation
- 3 Limited torsion tolerance
- 4 Light Weight
- 5 The patented push-button principle holds the links together
- 6 Cable-friendly interior
- 7 "E" Series features split crossbar along the outer radius
- 8 "Z" Series features split crossbar along the inner radius
- 9 Integrated strain relief option



Order example complete E-Chain®

Please indicate chain-lengths or number of links Example: 1 m or 50 links

1 m E08.30.038.0



E-Chain®

1 set 080.30.12PZ



Mounting bracket



Unsupported length

FL_G = with straight upper run

FL_B = with permitted sag

Further information ► **Design, page 1.12**

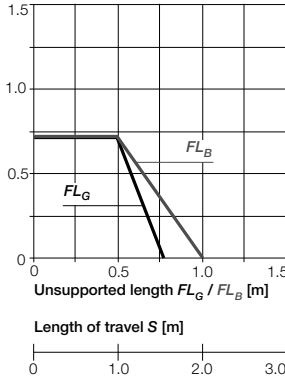
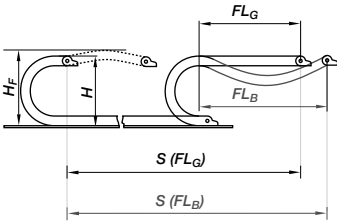

- S = Length of travel
- R = Bending radius
- H = Nominal clearance height
- H_F = Required clearance height
- D = Overlength E-Chain® radius in final position
- $K = \pi \cdot R + \text{"safety"}$

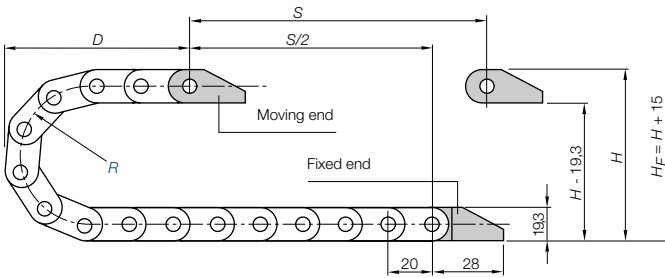

Pitch = 20 mm/link Links/m = 50 (1.000 mm) Chain length = $S/2 + K$

R	028	038	048
H	76	96	116
D	60	70	80
K	130	160	190

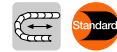

Short travels - unsupported

Unsupported E-Chains® feature positive camber over short travels. This must be accounted for when specifying the clearance height H_F . Please consult igus® if space is particularly restricted.

The required clearance height:
 $H_F = H + 15 \text{ mm}$
(with 0,3 kg/m fill weight)

Speed / acceleration FL_G	max. 20 [m/s] / max. 200 [m/s ²]
Speed / acceleration FL_B	max. 3 [m/s] / max. 6 [m/s ²]
Gliding speed / acceleration (maximum)	max. 3 [m/s] / max. 10 [m/s ²]
Material (E-Chain®)- permitted temperature °C	igumid NB / -40° up to +80° C
Material (mounting brackets)* - permitted temperature °C	igumid G / -40° up to +120° C
Flammability class (E-Chain®), igumid NB	VDE 0304 IIC UL94 V2
Flammability class (mounting brackets), igumid G*	VDE 0304 IIC UL94 HB

*Available in igumid NB upon request, please consult igus® for delivery time

Technical Data



Details of material properties
► page 1.38



Easy Chain®
Inner height: 14,6/14,7 mm

Phone +49- (0) 22 03-96 49-800
Fax +49- (0) 22 03-96 49-222



► page 3.5

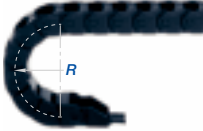
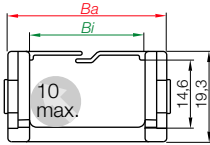

Part No. structure

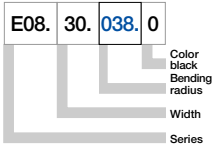

Series E08 - split crossbar along the outer radius

Part No.	<i>Bj</i> [mm]	<i>Ba</i> [mm]	<i>R</i> [mm]	Bending radii			Weight [kg/m]
E08.10.□.0	10	18,2	028	038	048	≈ 0,21	
E08.16.□.0	16	24,2	028	038	048	≈ 0,24	
E08.20.□.0	20	28,2	028	038	048	≈ 0,25	
E08.30.□.0	30	38,2	028	038	048	≈ 0,28	
E08.40.□.0	40	48,2	028	038	048	≈ 0,31	
E08.50.□.0	50	58,2	028	038	048	≈ 0,37	

Ba: pin dimension approx. 0,3 - 0,5 mm wider!

Supplement Part No. with required radius. Example: E08.30.038.0

0 = standard color, other colors ▶ page 1.39 · Pitch = 20 mm/link - Links/m = 50

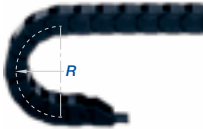
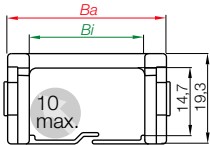

Part No. structure

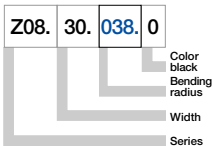

Series Z08 - split crossbar along the inner radius

Part No.	<i>Bj</i> [mm]	<i>Ba</i> [mm]	<i>R</i> [mm]	Bending radii			Weight [kg/m]
Z08.10.□.0	10	18,2	028	038	048	≈ 0,21	
Z08.16.□.0	16	24,2	028	038	048	≈ 0,24	
Z08.20.□.0	20	28,2	028	038	048	≈ 0,25	
Z08.30.□.0	30	38,2	028	038	048	≈ 0,28	
Z08.40.□.0	40	48,2	028	038	048	≈ 0,31	
Z08.50.□.0	50	58,2	028	038	048	≈ 0,37	

Ba: pin dimension approx. 0,3 - 0,5 mm wider!

Supplement Part No. with required radius. Example: Z08.30.038.0

0 = standard color, other colors ▶ page 1.39 · Pitch = 20 mm/link - Links/m = 50





Polymer, one-piece

- One-piece mounting bracket
- Corrosion-resistant
- Available preassembled
- Inner and outer attachment possible
- Available with integrated strain relief tiewrap plates

Moving end with bore
(outer link) 080...1 (PZ)

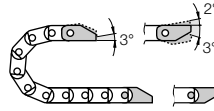

080...2(PZ) Fixed end
with pin (inner link)

Possible installation conditions for assembled mounting brackets ▶ Order example "preassembled" below

080...1 (PZ)
Moving end

080...2 (PZ)
Fixed end

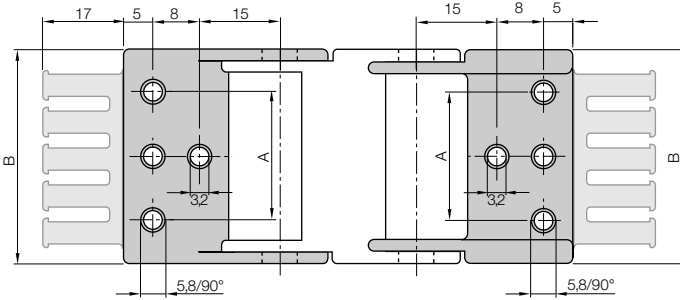

080.10.12 - 080.20.12: center bores only
080.30.12 - 080.50.12: all bores

For E-Chain®	Part No. full set with tiewrap plate	Part No. full set without tiewrap plate	Number of teeth	Dim. A [mm]	Dim. B [mm]
E08-Z08.10. ▶	080.10.12 PZ	080.10.12	1	-	18,2
E08-Z08.16. ▶	080.16.12 PZ	080.16.12	2	-	24,2
E08-Z08.20. ▶	080.20.12 PZ	080.20.12	2	-	28,2
E08-Z08.30. ▶	080.30.12 PZ	080.30.12	3	22	38,2
E08-Z08.40. ▶	080.40.12 PZ	080.40.12	4	32	48,2
E08-Z08.50. ▶	080.50.12 PZ	080.50.12	5	42	58,2

For the preassembled mode please add the index A1 ... A4 e.g. 080.10.12 PZ A1

Dimensions and order configurations

Strain relief is possible on the moving end and/or the fixed end.

Part No. structure

080.10.12 PZ A1

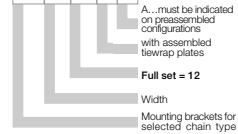

Full set, for both ends:

080.10.12 PZ +tiewrap plate

Single-part order:

080.10.1 PZ +tiewrap plate

Mounting bracket with bore

080.10.2 PZ +tiewrap plate

Mounting bracket with pin



Quicksnap - the complete, detachable mounting unit, available upon request



Quickfix - mounting bracket with dowel, available upon request

Additional Features





Price index



IPA Qualification Certificate:
Air Cleanless Class ISO Class 2
(at v = 1 m/s) upon request



UL94-V2
classifications



Torsional
motion possible



IPA Qualification Certificate: ESD
Classification Level 1 (for Series
E14.3.038). Special equipment:
Electrically conductive ESD/ATEX
version upon request



Just push the cables with your thumb
into the E-Chain® - and it's ready



When to use the Series E14/Z14:

- If filling is required without opening and closing lids
- If price is an issue
- If quiet operation is required



When not to use it:

- For applications with very high loads and long unsupported travel lengths
 - ▶ Series B15 E2 mini, page 5.70
- "Z" Series is unsuitable for gliding applications
 - ▶ Series B15 E2 mini, page 5.70

- 1 Limited torsion tolerance
- 2 Very easy to fill - ideal for harnessed cable assemblies
- 3 The patented push-button principle holds the links together
- 4 Small pitch for low-noise, smooth operation
- 5 Cable-friendly interior
- 6 "E" Series features split crossbar along the outer radius
- 7 "Z" Series features split crossbar along the inner radius
- 8 Integrated strain relief option



Order example complete E-Chain®

Please indicate chain-lengths or number of links Example: 1 m or 33 links

1 m E14.3.038.0



E-Chain®

1 set 114.3.12PZ



Mounting bracket



Unsupported length

FL_G = with straight upper run

FL_B = with permitted sag

Further information ► **Design, page 1.12**

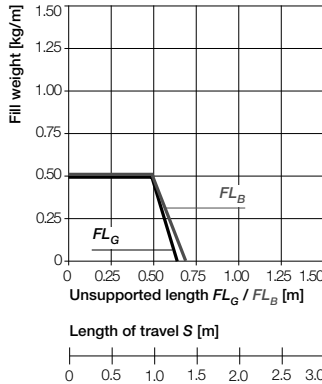
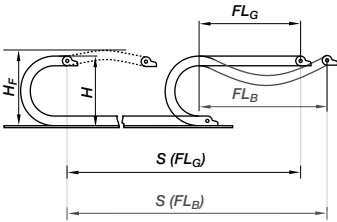

- S = Length of travel
- R = Bending radius
- H = Nominal clearance height
- H_F = Required clearance height
- D = Overlength E-Chain® radius in final position
- $K = \pi \cdot R + \text{"safety"}$

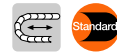
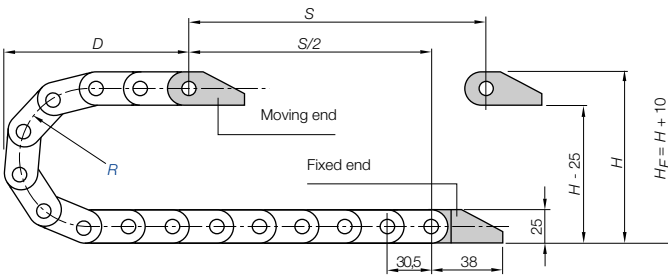

Short travels - unsupported

Unsupported E-Chains® feature positive camber over short travels. This must be accounted for when specifying the clearance height H_F . Please consult igus® if space is particularly restricted.

Pitch = 30,5 mm/link Links/m = 33 (1.006,5 mm) Chain length = $S/2 + K$

R	028	038	048	075	100	125
H	82	102	122	177	227	277
D	71	81	91	120	145	170
K	150	185	215	300	375	455

The required clearance height:
 $H_F = H + 10$ mm
(with 0,2 kg/m fill weight)



Easy Chain®
Inner height: 19 mm

Phone +49- (0) 22 03-96 49-800
Fax +49- (0) 22 03-96 49-222



Speed / acceleration FL_G	max. 20 [m/s] / max. 200 [m/s²]
Speed / acceleration FL_B	max. 3 [m/s] / max. 6 [m/s²]
Gliding speed / acceleration (maximum)	max. 3 [m/s] / max. 10 [m/s²]
Material (E-Chain®)- permitted temperature °C	igumid NB / -40° up to +80° C
Material (mounting brackets)* - permitted temperature °C	igumid G / -40° up to +120° C
Flammability class (E-Chain®), igumid NB	VDE 0304 IIC UL94 V2
Flammability class (mounting brackets), igumid G*	VDE 0304 IIC UL94 HB

*Available in igumid NB upon request, please consult igus® for delivery time

Technical Data



Details of material properties
► page 1.38



► page 3.5

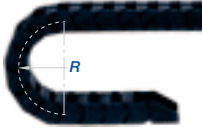
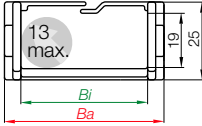

Part No. structure

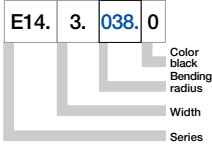

Series E14 - split crossbar along the outer radius

Part No.	Bi [mm]	Ba [mm]	R [mm]	Bending radii					Weight [kg/m]
E14.1. <input type="text"/> .0	15	27	028	038	048	075	100	125	≈ 0,31
E14.2. <input type="text"/> .0	25	37	028	038	048	075	100	125	≈ 0,32
E14.3. <input type="text"/> .0	38	50	028	038	048	075	100	125	≈ 0,40
E14.4. <input type="text"/> .0	50	62	028	038	048	075	100	125	≈ 0,44

Ba: pin dimension approx. 0,3 - 0,5 mm wider!

Supplement Part No. with required radius. Example: E14.3. .0

0 = standard color, other colors ▶ page 1.39 - Pitch = 30,5 mm/link - Links/m = 33

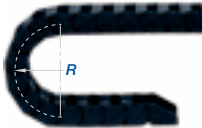
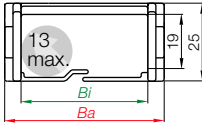

Part No. structure

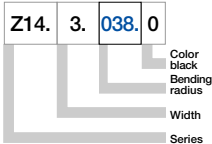

Series Z14 - split crossbar along the inner radius

Part No.	Bi [mm]	Ba [mm]	R [mm]	Bending radii					Weight [kg/m]
Z14.1. <input type="text"/> .0	15	27	028	038	048	075	100	125	≈ 0,31
Z14.2. <input type="text"/> .0	25	37	028	038	048	075	100	125	≈ 0,32
Z14.3. <input type="text"/> .0	38	50	028	038	048	075	100	125	≈ 0,40
Z14.4. <input type="text"/> .0	50	62	028	038	048	075	100	125	≈ 0,44

Ba: pin dimension approx. 0,3 - 0,5 mm wider!

Supplement Part No. with required radius. Example: Z14.3. .0

0 = standard color, other colors ▶ page 1.39 - Pitch = 30,5 mm/link - Links/m = 33





Polymer, one-piece

- One-piece mounting bracket
- Corrosion-resistant
- Available preassembled
- Inner and outer attachment possible
- Available with integrated strain relief tiwrap plates

Moving end with bore
(outer link) 114...1P(Z)

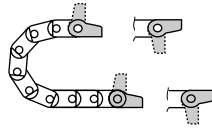

114...2P(Z) Fixed end
with pin (inner link)



Possible installation conditions for assembled mounting brackets ▶ Order example "preassembled" below

114...1P(Z)
Moving end

114...2P(Z)
Fixed end

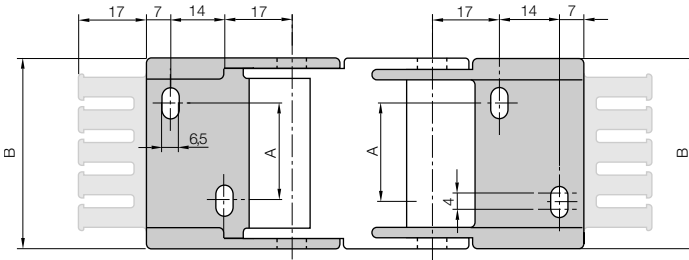

Dimensions and order configurations

Strain relief is possible on the moving end and/or the fixed end.

Part No. structure

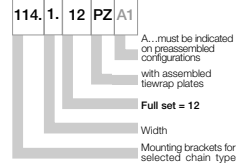

Full set, for both ends:

114.1.12 PZ +tiwrap plate

Single-part order:

114.1.1 PZ +tiwrap plate

Mounting bracket with bore

114.1.2 PZ +tiwrap plate

Mounting bracket with pin

For E-Chain®	Part No. full set with tiwrap plate	Part No. full set without tiwrap plate	Number of teeth	Dim. A [mm]	Dim. B [mm]
E14-Z14.1. ▶	114.1.12PZ	114.1.12P	2	-	26,3
E14-Z14.2. ▶	114.2.12PZ	114.2.12P	3	10	36,3
E14-Z14.3. ▶	114.3.12PZ	114.3.12P	4	23	49,3
E14-Z14.4. ▶	114.4.12PZ	114.4.12P	5	35	62,3

Please add the Part No. with the requested index - e.g. 114.1.12

For the preassembled mode please add the index A1...A4 e.g. 114.1.12PZA1



Quicksnap - the complete, detachable mounting unit, available upon request



Quickfix - mounting bracket with dowel, available upon request

Additional Features





Price index



IPA Qualification Certificate:
Air Cleanless Class ISO Class 2
(at v = 1 m/s) upon request



UL94-V2
classifications



Torsional
motion possible



Special equipment:
Electrically conductive ESD/ATEX
version upon request



Just push the cables with your thumb
into the E-Chain® - and it's ready



When to use the Series E200/Z200:

- If filling is required without opening and closing lids
- If price is an issue
- If quiet operation is required



When not to use it:

- For applications with very high loads and long unsupported travel lengths
 - ▶ Series 2400/2450/2480/2500 E2/000, page 5.102
- If single-extrusion crossbars are required
 - ▶ Series 2400/2450/2480/2500 E2/000, page 5.102

- 1 Large pins for long service life
- 2 Limited torsion tolerance
- 3 "E" Series features split crossbar along the outer radius
- 4 "Z" Series features split crossbar along the inner radius
- 5 Cable-friendly interior
- 6 Mounting bracket with integrated strain relief
- 7 Dirt-repellent exterior
- 8 Very easy to fill - cables only have to be pushed in
- 9 The patented push-button principle holds the links together
- 10 1- or 2-chamber system available

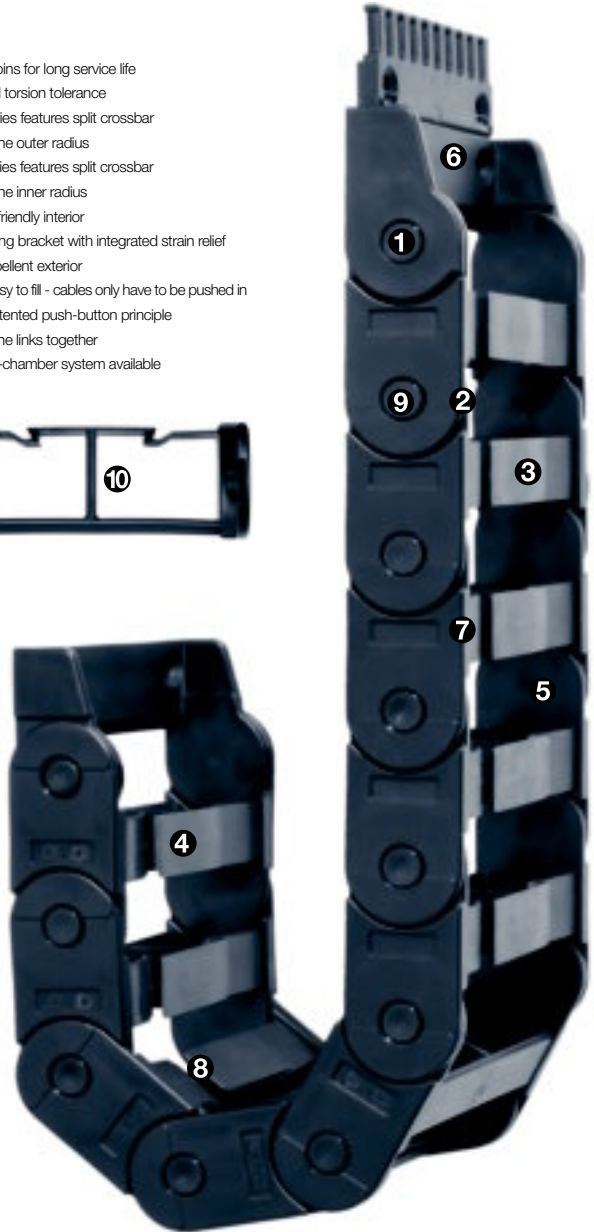
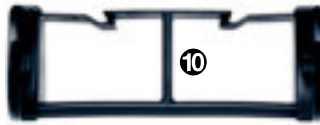

Order example complete E-Chain®

Please indicate chain-lengths or number of links Example: 1 m or 22 links

1 m E200.05.100.0



E-Chain®

1 set 2050.34.PZB



Mounting bracket



Unsupported length

FL_G = with straight upper run

FL_B = with permitted sag

Further information ► **Design, page 1.12**

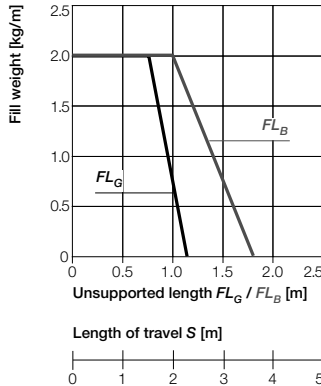
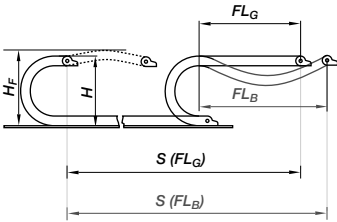

- S = Length of travel
- R = Bending radius
- H = Nominal clearance height
- H_F = Required clearance height
- D = Overlength E-Chain® radius in final position
- $K = \pi \cdot R + \text{"safety"}$

Other installation methods

- Vertical, hanging ≤ 10 m
- Vertical, standing $\leq 1,5$ m
- Side mounted, un supp. $\leq 0,5$ m
- Rotary requires further calculation
- Unsupported length of upper run = upon request

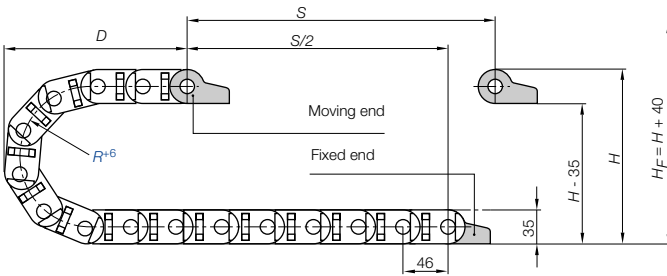

Pitch = 46 mm/link Links/m = 22 (1.012 mm) Chain length = $S/2 + K$

R	055	075	100	150	200
H^{+4}	145	185	235	335	435
D	125	150	170	220	270
K	276	346	414	578	742

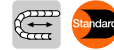

Short travels - unsupported

Unsupported E-Chains® feature positive camber over short travels. This must be accounted for when specifying the clearance height H_F . Please consult igus® if space is particularly restricted.

The required clearance height:
 $H_F = H + 40$ mm
(with 2,5 kg/m fill weight)

Speed / acceleration FL_G	max. 20 [m/s] / max. 200 [m/s ²]
Speed / acceleration FL_B	max. 3 [m/s] / max. 6 [m/s ²]
Gliding speed / acceleration (maximum)	max. 3 [m/s] / max. 10 [m/s ²]
Material (E-Chain®)- permitted temperature °C	igumid NB / -40° up to +80° C
Material (mounting brackets)* - permitted temperature °C	igumid G / -40° up to +120° C
Flammability class (E-Chain®), igumid NB	VDE 0304 IIC UL94 V2
Flammability class (mounting brackets), igumid G*	VDE 0304 IIC UL94 HB

*Available in igumid NB upon request, please consult igus® for delivery time

Technical Data



Details of material properties
► page 1.38

24,3

Easy Chain®
Inner height: 24,3 mm

Phone +49- (0) 22 03-96 49-800
Fax +49- (0) 22 03-96 49-222



► page 3.5



igus® E-ChainSystems®

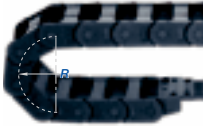
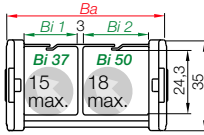
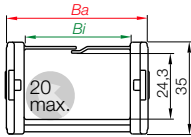

Part No. structure

E200. 05. 100. 0



Series E200 - split crossbar along the outer radius

Part No.	Bi [mm]	Ba [mm]	R [mm]	Bending radii					Weight [kg/m]
E200.05. <input type="text"/> .0	57	74,4	055	075	100	150	200	≈ 0,70	

Ba: pin dimension approx. 0,1 - 0,3 mm wider!

Supplement Part No. with required radius. Example: E200.05. .0

0 = standard color, other colors ▶ page 1.39 · Pitch = 46 mm/link - Links/m = 22

Series E200 - split crossbar along the outer radius with 2-chamber system

Part No.	Bi [mm]	Ba [mm]	R [mm]	Bending radii					Weight [kg/m]
E200.2/35. <input type="text"/> .0	37	94,4	055	075	100	150	200	≈ 0,79	
E200.2/50. <input type="text"/> .0	50	120,4	055	075	100	150	200	≈ 0,82	

Ba: pin dimension approx. 0,1 - 0,3 mm wider!

Supplement Part No. with required radius. Example: E200.2/50. .0

0 = standard color, other colors ▶ page 1.39 · Pitch = 46 mm/link - Links/m = 22



Phone +49- (0) 22 03-96 49-800
Fax +49- (0) 22 03-96 49-222

igus® GmbH
51147 Cologne

Internet: www.igus.eu
E-mail: info@igus.de

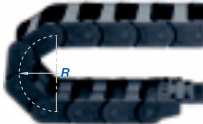
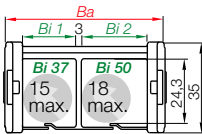
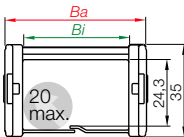

Part No. structure

Z200. 05. 100. 0

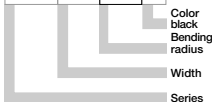

Series Z200 - split crossbar along the inner radius

Part No.	Bi [mm]	Ba [mm]	R [mm]	Bending radii					Weight [kg/m]
Z200.05. <input type="text"/> .0	57	74,4	055	075	100	150	200	≈ 0,70	

Ba: pin dimension approx. 0,1 - 0,3 mm wider!

Supplement Part No. with required radius. Example: Z200.05. .0

0 = standard color, other colors ▶ page 1.39 · Pitch = 46 mm/link - Links/m = 22

Series Z200 - split crossbar along the inner radius with 2-chamber system

Part No.	Bi [mm]	Ba [mm]	R [mm]	Bending radii					Weight [kg/m]
Z200.2/35. <input type="text"/> .0	37	94,4	055	075	100	150	200	≈ 0,79	
Z200.2/50. <input type="text"/> .0	50	120,4	055	075	100	150	200	≈ 0,82	

Ba: pin dimension approx. 0,1 - 0,3 mm wider!

Supplement Part No. with required radius. Example: Z200.2/50. .0

0 = standard color, other colors ▶ page 1.39 · Pitch = 46 mm/link - Links/m = 22



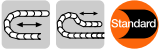

The Standard - option polymer - pivoting

- Recommended for unsupported and gliding applications
- Well suited for tight installation conditions
- Strain relief with detachable tiwrap plates
- Variable traverse angle for flexible assembly
- The twistability of the E-Chain® and the option to assemble the mounting brackets on the fixed end and/or the moving end, enable various installation options

Moving end with bore
(outer link) 2...3PZ(B)

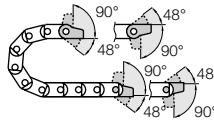

2...4PZ(B) Fixed end
with pin (inner link)

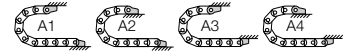

Possible installation conditions for assembled mounting brackets ▶ Order example "preassembled" below

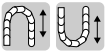

Option polymer - locking

- Recommended for unsupported and gliding applications
- Furthermore:
- At very high speed and/or acceleration
 - If space is limited for height (the H_F measurement)
 - The twistability of the E-Chain® and the option to assemble the mounting brackets on the fixed end and/or the moving end, enable various installation options

Moving end with bore
(outer link) 2...1PZ(B)

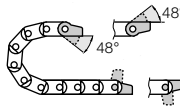

2...2PZ(B) Fixed end
with pin (inner link)

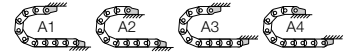

Possible installation conditions for assembled mounting brackets ▶ Order example "preassembled" below

2...3PZ(B) Standard! (pivoting)

2...1PZ(B) (locking)

Moving end

Standard! (pivoting) 2...4PZ(B)

(locking) 2...2PZ(B)

Fixed end

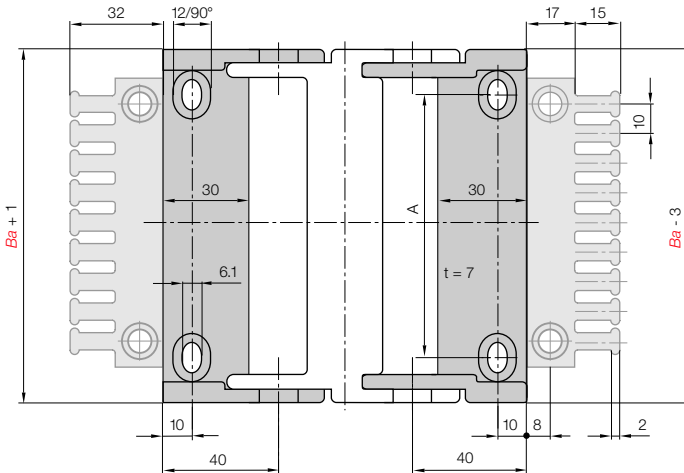

Dimensions and order configurations

Strain relief is possible on the moving end and/or the fixed end.

Part No. structure (pivoting)

2050. 34 PZB A1

A...must be indicated on preassembled configurations with assembled tiwrap plates
Full set pivoting = 34
Mounting brackets for selected chain type

Full set, for both ends:

2050. [34] PZB +tiwrap plate

Single-part order:

2050. [3] PZB +tiwrap plate

Mounting bracket with bore

2050. [4] PZB +tiwrap plate

Mounting bracket with pin

Part No. structure (locking)

2050. 12 PZB A1

A...must be indicated on preassembled configurations with assembled tiwrap plates
Full set locking = 12
Mounting brackets for selected chain type

Full set, for both ends:

2050. [12] PZB +tiwrap plate

Single-part order:

2050. [1] PZB +tiwrap plate

Mounting bracket with bore

2050. [2] PZB +tiwrap plate

Mounting bracket with pin

For E-Chain®	Part No. full set with tiwrap plate	Part No. tiwrap plate + 10 cable tiwraps	Part No. full set without tiwrap plate	Number of teeth	Dim. A [mm]
E200-Z200.05	2050. [] PZB	2050. [] PZBK1	2050. [] PZ	6	44
E200-Z200.2/35	2070. [] PZB	2070. [] PZBK1	2070. [] PZ	8	64
E200-Z200.2/50	2100. [] PZB	2100. [] PZBK1	2100. [] PZ	10	90

Please add the Part No. with the requested index - 34 for the pivoting configuration

e.g. 2050. [34] PZB or 12 for the locking configuration e.g. 2050. [12] PZB

For the preassembled mode please add the index [A1]...[A4] e.g. 2050. [34] PZB [A1]

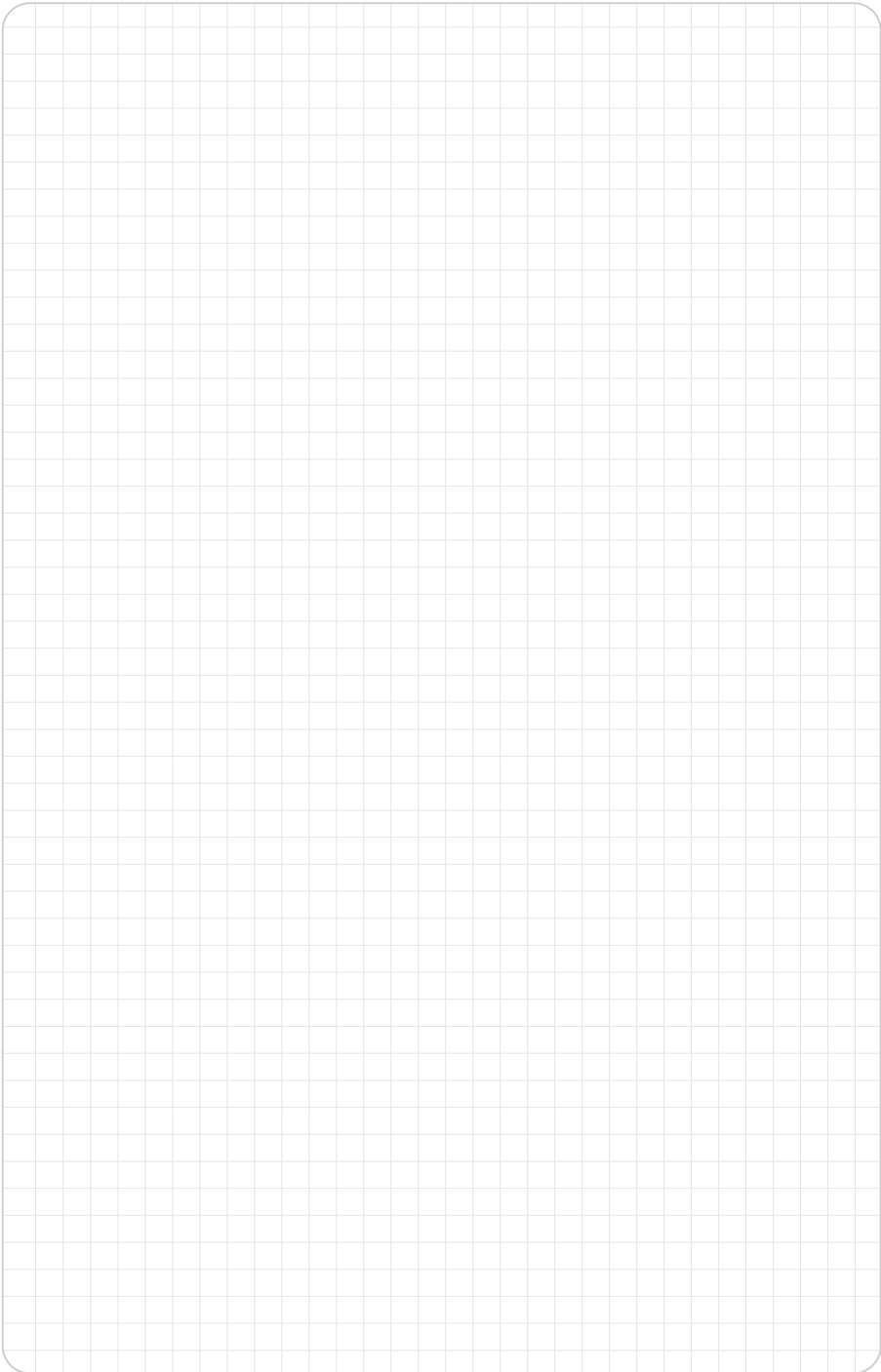

Easy Chain®
Inner height: 24,3 mm

Phone +49- (0) 22 03-96 49-800
Fax +49- (0) 22 03-96 49-222



▶ chapter 10



▶ page 3.5



Price index



IPA Qualification Certificate:
Air Cleanless Class ISO Class 2
(at v = 1 m/s) upon request



UL94-V2
classifications



Torsional
motion possible



Special equipment:
Electrically conductive ESD/ATEX
version upon request



Just push the cables with your thumb
into the E-Chain® - and it's ready



When to use the Series E16/Z16:

- If filling is required without opening and closing lids
- If price is an issue
- If quiet operation is required



When not to use it:

- For applications with very high loads and long unsupported travel lengths
▶ Series 2600/2650/2680/2700
E2/000, page 5.114
- If a E-Chain® is needed with a high locking crossbar
▶ Series 2600/2650/2680/2700
E2/000, page 5.114

- ① Limited torsion tolerance
- ② Small pitch for low-noise, smooth operation
- ③ Very easy to fill - ideal for harnessed cable assemblies
- ④ Cable-friendly interior
- ⑤ "E" Series features split crossbar along the outer radius
- ⑥ "Z" Series features split crossbar along the inner radius
- ⑦ Mounting brackets with integrated strain relief
- ⑧ The patented push-button principle holds the links together



Special solution -
opening gap
Part No. E16.2.100N3



Special solution -
opening gap
Part No. Z16.2.075N3



Order example complete E-Chain®

Please indicate chain-lengths or number of links Example: 1 m or 33 links

1 m E16.3.060.0



E-Chain®

1 set 117.3.12PZ



Mounting bracket



Unsupported length

FL_G = with straight upper run

FL_B = with permitted sag

Further information ► **Design, page 1.12**

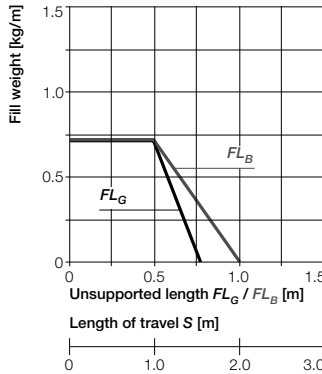
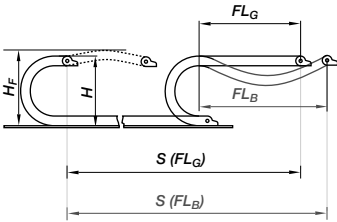

- S = Length of travel
- R = Bending radius
- H = Nominal clearance height
- H_F = Required clearance height
- D = Overlength E-Chain® radius in final position
- $K = \pi \cdot R + \text{"safety"}$

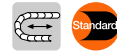
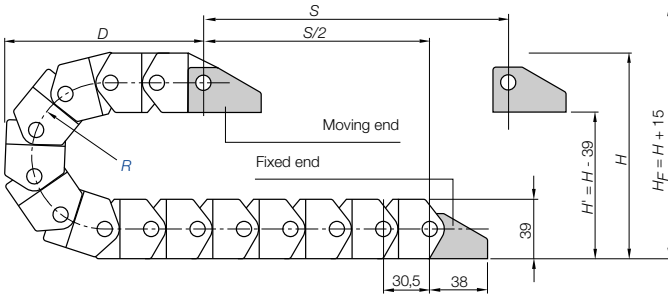

Short travels - unsupported

Unsupported E-Chains® feature positive camber over short travels. This must be accounted for when specifying the clearance height H_F . Please consult igus® if space is particularly restricted.

Pitch = 30,5 mm/link Links/m = 33 (1.006,5mm) Chain length = $S/2 + K$

R	040	060	075	100
H	119	159	189	239
D	085	110	130	155
K	210	270	305	395

The required clearance height:
 $H_F = H + 15$ mm
(with 0,3 kg/m fill weight)

Speed / acceleration FL_G	max. 20 [m/s] / max. 200 [m/s ²]
Speed / acceleration FL_B	max. 3 [m/s] / max. 6 [m/s ²]
Gliding speed / acceleration (maximum)	max. 3 [m/s] / max. 10 [m/s ²]
Material (E-Chain®)- permitted temperature °C	igumid NB / -40° up to +80° C
Material (mounting brackets)* - permitted temperature °C	igumid G / -40° up to +120° C
Flammability class (E-Chain®), igumid NB	VDE 0304 IIC UL94 V2
Flammability class (mounting brackets), igumid G*	VDE 0304 IIC UL94 HB

*Available in igumid NB upon request, please consult igus® for delivery time

Technical Data



Details of material properties
► page 1.38



Easy Chain®
Inner height: 32 mm

Phone +49- (0) 22 03-96 49-800
Fax +49- (0) 22 03-96 49-222



► page 3.5

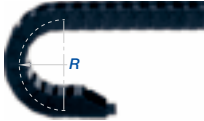
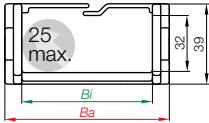

Part No. structure

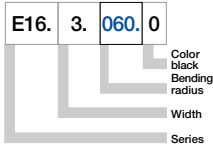

Series E16 - split crossbar along the outer radius

Part No.	Bending radii						Weight [kg/m]
	<i>Bi</i> [mm]	<i>Ba</i> [mm]	<i>R</i> [mm]				
E16.2.□.0	23	37,5	060	075	100	≈ 0,51	
E16.3.□.0	36	50,5	060	075	100	≈ 0,57	
E16.4.□.0	48	62,5	060	075	100	≈ 0,62	
E16.5.□.0	63	78,5	060	075	100	≈ 0,75	
E16.6.□.0	80	95,5	060	075	100	≈ 0,83	
E16.7.□.0	100	115,3	060	075	100	≈ 0,91	

Ba: pin dimension approx. 0,3 - 0,7 mm wider

The bending radius **125** is available upon request.

Delivery time: approx. 3-4 weeks after receipt of order!

Supplement Part No. with required radius. Example: E16.3.**060**.0

0 = standard color, other colors ▶ page 1.39 · Pitch = 30,5 mm/link - Links/m = 33

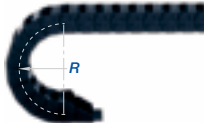
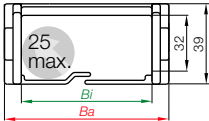

Part No. structure

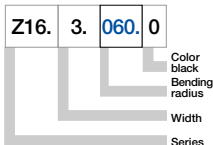

Series Z16 - split crossbar along the inner radius

Part No.	Bending radii						Weight [kg/m]
	<i>Bi</i> [mm]	<i>Ba</i> [mm]	<i>R</i> [mm]				
Z16.2.□.0	23	37,5	060	075	100	≈ 0,51	
Z16.3.□.0	36	50,5	040	060	075	≈ 0,57	
Z16.4.□.0	48	62,5	040	060	075	≈ 0,62	
Z16.5.□.0	63	78,5	060	075	100	≈ 0,75	
Z16.6.□.0	80	95,5	060	075	100	≈ 0,83	
Z16.7.□.0	100	115,3	060	075	100	≈ 0,91	

Ba: pin dimension approx. 0,3 - 0,7 mm wider

The bending radius **125** is available upon request.

Delivery time: approx. 3-4 weeks after receipt of order!

Supplement Part No. with required radius. Example: Z16.3.**060**.0

0 = standard color, other colors ▶ page 1.39 · Pitch = 30,5 mm/link - Links/m = 33





Polymer, one-piece

- One-piece mounting bracket
- Corrosion-resistant
- Available preassembled
- Inner and outer attachment possible
- Available with integrated strain relief tiwrap plates
- 90° * not for Series Z16

Moving end with bore
(outer link) 117...1P(Z)

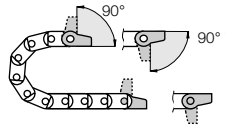

117...2P(Z) Fixed end
with pin (inner link)



Possible installation conditions for assembled mounting brackets ▶ Order example "preassembled" below

117...1P(Z)
Moving end

117...2P(Z)
Fixed end

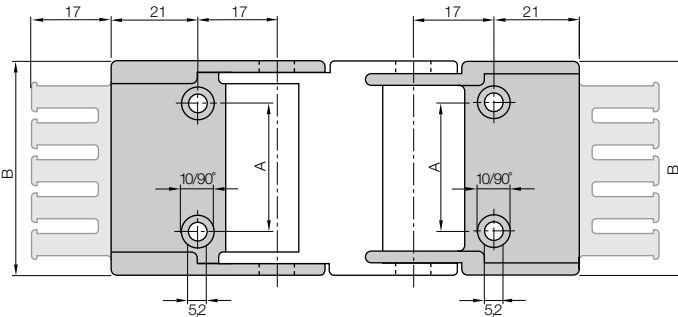

Dimensions and order configurations

Strain relief is possible on the moving end and/or the fixed end.

For E-Chain®	Part No. full set with tiwrap plate	Part No. full set without tiwrap plate	Number of teeth	Dim. A [mm]	Dim. B [mm]
E16-Z16.2. ▶	117.[2].12PZ	117.[2].12P	3	12	35,5
E16-Z16.3. ▶	117.[3].12PZ	117.[3].12P	4	25	48,5
E16-Z16.4. ▶	117.[4].12PZ	117.[4].12P	5	37	60,5
E16-Z16.5. ▶	117.[5].12PZ	117.[5].12P	6	48	76,0
E16-Z16.6. ▶	117.[6].12PZ	117.[6].12P	8	65	93,0
E16-Z16.7. ▶	117.[7].12PZ	117.[7].12P	10	85	113,0

Please add the Part No. with the requested index - e.g. 117.[2].12PZ

For the preassembled mode please add the index [A1] ... [A4] e.g. 117.[2].12PZ[A1]

Part No. structure

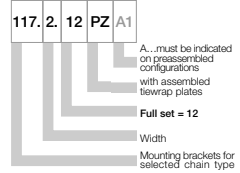

Full set, for both ends:

117.[2].12 PZ +tiwrap plate

Single-part order:

117.[2].1 PZ +tiwrap plate

Mounting bracket with bore

117.[2].2 PZ +tiwrap plate

Mounting bracket with pin

Phone +49- (0) 22 03-96 49-800
Fax +49- (0) 22 03-96 49-222



Quicksnap - the complete, detachable mounting unit, available upon request

Quickfix - mounting bracket with dowel, available upon request

Additional Features



Price index



IPA Qualification Certificate:
Air Cleanless Class ISO Class 2
(at v = 1 m/s) upon request



UL94-V2
classifications



Torsional
motion possible



Special equipment:
Electrically conductive ESD/ATEX
version upon request



Just push the cables with your thumb
into the E-Chain® - and it's ready



When to use the Series E26/Z26:

- If filling is required without opening and closing lids
- If price is an issue
- If quiet operation is required



When not to use it:

- For applications with very high loads and long unsupported travel lengths
 - ▶ Series 3400/3450/3480/3500
E2/000, page 5.126
- If a E-Chain® is needed with a high locking crossbar
 - ▶ Series 3400/3450/3480/3500
E2/000, page 5.126

- ① Limited torsion tolerance
- ② Large pins for long service life
- ③ Cable-friendly interior
- ④ Integrated strain relief option
- ⑤ "E" Series features split crossbar along the outer radius
- ⑥ "Z" Series features split crossbar along the inner radius
- ⑦ Dirt-repellent exterior
- ⑧ Very easy to fill
- ⑨ 1-, 2- or 3-chamber system available
- ⑩ The patented push-button principle holds the links together



Order example complete E-Chain®

Please indicate chain-lengths or number of links Example: 1 m or 18 links

1 m E26.07.150.0



E-Chain®

1 set 2607.34.PZB



Mounting bracket



Unsupported length

FL_G = with straight upper run

FL_B = with permitted sag

Further information ► **Design, page 1.12**

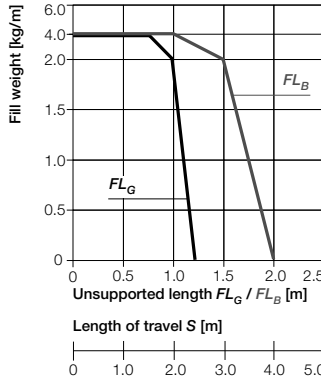
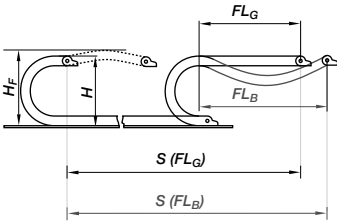

- S = Length of travel
- R = Bending radius
- H = Nominal clearance height
- H_F = Required clearance height
- D = Overlength E-Chain* radius in final position
- $K = \pi \cdot R + \text{"safety"}$

Other installation methods

- Vertical, hanging ≤ 10 m
- Vertical, standing $\leq 1,5$ m
- Side mounted, un supp. $\leq 0,5$ m
- Rotary requires further calculation
- Unsupported length of upper run = upon request

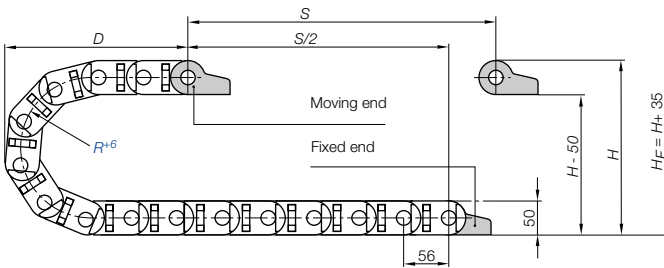

Pitch = 56 mm/link Links/m = 18 (1.008 mm) Chain length = $S/2 + K$

R	063	075	100	125	150	175	200	250
H^{+5}	180	200	250	300	350	400	450	550
D	140	150	175	200	225	250	275	325
K	335	375	475	550	650	750	825	925

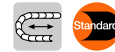

Short travels - unsupported

Unsupported E-Chains* feature positive camber over short travels. This must be accounted for when specifying the clearance height H_F . Please consult igus* if space is particularly restricted.

The required clearance height:
 $H_F = H + 35$ mm
(with 2,0 kg/m fill weight)

36,5

Easy Chain®
Inner height: 36,5 mm

Phone +49- (0) 22 03-96 49-800
Fax +49- (0) 22 03-96 49-222



Speed / acceleration FL_G	max. 20 [m/s] / max. 200 [m/s ²]
Speed / acceleration FL_B	max. 3 [m/s] / max. 6 [m/s ²]
Gliding speed / acceleration (maximum)	max. 3 [m/s] / max. 10 [m/s ²]
Material (E-Chain)* - permitted temperature °C	igumid NB / -40° up to +80° C
Material (mounting brackets)* - permitted temperature °C	igumid G / -40° up to +120° C
Flammability class (E-Chain)*, igumid NB	VDE 0304 IIC UL94 V2
Flammability class (mounting brackets), igumid G*	VDE 0304 IIC UL94 HB

Available in igumid NB upon request, please consult igus for delivery time

Technical Data



Details of material properties
► page 1.38



► page 3.5

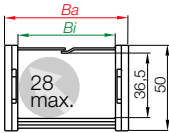

Series E26 - split crossbar along the outer radius

Part No.	Bi [mm]	Ba [mm]	R [mm]	Bending radii							Weight [kg/m]
E26.07. <input type="text" value="0"/>	75	92	063	075	100	125	150	175	200	250	≈ 0,96

Ba: pin dimension approx. 0,3 - 0,5 mm wider!

Supplement Part No. with required radius. Example: E26.07..0

0 = standard color, other colors ► page 1.39 · Pitch = 56 mm/link - Links/m = 18

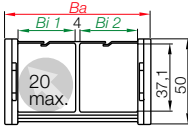

Series E26 - split crossbar along the outer radius with 2-chamber system

Part No.	Bi [mm]	Ba [mm]	R [mm]	Bending radii							Weight [kg/m]
E26.2/45. <input type="text" value="0"/>	48/48	117	063	075	100	125	150	175	200	250	≈ 1,14

Ba: pin dimension approx. 0,3 - 0,5 mm wider!

Supplement Part No. with required radius. Example: E26.2/45..0

0 = standard color, other colors ► page 1.39 · Pitch = 56 mm/link - Links/m = 18

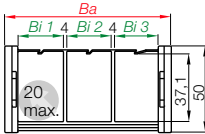

Series E26 - split crossbar along the outer radius with 3-chamber system

Part No.	Bi [mm]	Ba [mm]	R [mm]	Bending radii							Weight [kg/m]
E26.3/45. <input type="text" value="0"/>	47/48/47	167	063	075	100	125	150	175	200	250	≈ 1,30

Ba: pin dimension approx. 0,3 - 0,5 mm wider!

Supplement Part No. with required radius. Example: E26.3/45..0

0 = standard color, other colors ► page 1.39 · Pitch = 56 mm/link - Links/m = 18

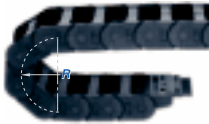

Part No. structure

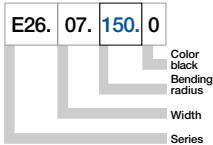

Series Z26 - split crossbar along the inner radius

Part No.	<i>B_i</i> [mm]	<i>B_a</i> [mm]	<i>R</i> [mm]	Bending radii	Weight [kg/m]
Z26.07.□.0	75	92	063	075 100 125 150 175 200 250	≈ 0,96

B_a: pin dimension approx. 0,3 - 0,5 mm wider!

Supplement Part No. with required radius. Example: Z26.07.150.0

0 = standard color, other colors ▶ page 1.39 · Pitch = 56 mm/link - Links/m = 18

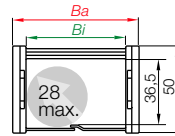

Series Z26 - split crossbar along the inner radius with 2-chamber system

Part No.	<i>B_i</i> [mm]	<i>B_a</i> [mm]	<i>R</i> [mm]	Bending radii	Weight [kg/m]
Z26.2/45.□.0	48/48	117	063	075 100 125 150 175 200 250	≈ 1,14

B_a: pin dimension approx. 0,3 - 0,5 mm wider!

Supplement Part No. with required radius. Example: Z26.2/45.150.0

0 = standard color, other colors ▶ page 1.39 · Pitch = 56 mm/link - Links/m = 18

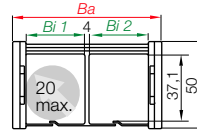

Series Z26 - split crossbar along the inner radius with 3-chamber system

Part No.	<i>B_i</i> [mm]	<i>B_a</i> [mm]	<i>R</i> [mm]	Bending radii	Weight [kg/m]
Z26.3/45.□.0	47/48/47	167	063	075 100 125 150 175 200 250	≈ 1,30

B_a: pin dimension approx. 0,3 - 0,5 mm wider!

Supplement Part No. with required radius. Example: Z26.3/45.150.0

0 = standard color, other colors ▶ page 1.39 · Pitch = 56 mm/link - Links/m = 18

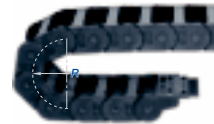
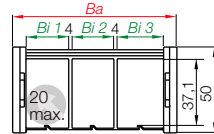

Part No. structure

Z26.	07.	150.	0
------	-----	------	---



Easy Chain®
Inner height: 36,5 mm

Phone +49- (0) 22 03-96 49-800
Fax +49- (0) 22 03-96 49-222



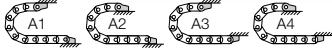

Possible installation conditions for assembled mounting brackets ▶ Order example "preassembled" below

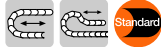

The Standard - option polymer - pivoting

- Recommended for unsupported and gliding applications
- Well suited for tight installation conditions
- Strain relief with detachable tiewrap plates
- Variable traverse angle for flexible assembly
- The twistability of the E-Chain® and the option to assemble the mounting brackets on the fixed end and/or the moving end, enable various installation options

Moving end with bore
(outer link) 26...3PZ(B)

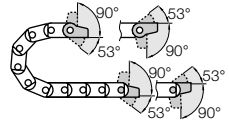

26...4PZ(B) Fixed end
with pin (inner link)



Possible installation conditions for assembled mounting brackets ▶ Order example "preassembled" below

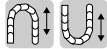

Option polymer - locking

- Recommended for unsupported and gliding applications
- At very high speed and/or acceleration
- If space is limited for height (the H_F measurement)
- The twistability of the E-Chain® and the option to assemble the mounting brackets on the fixed end and/or the moving end, enable various installation options

Moving end with bore
(outer link) 26...1PZ(B)

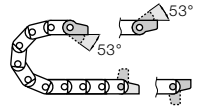

26...2PZ(B) Fixed end
with pin (inner link)

Dimensions and order configurations

Strain relief is possible on the moving end and/or the fixed end.

Part No. structure (pivoting)

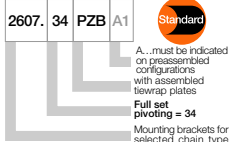

Full set, for both ends:

2607. 34 PZB + tiewrap plate

Single-part order:

2607. 3 PZB + tiewrap plate

Mounting bracket with bore

2607. 4 PZB + tiewrap plate

Mounting bracket with pin

Part No. structure (locking)

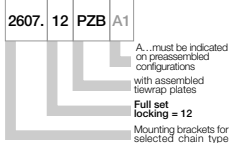

Full set, for both ends:

2607. 12 PZB + tiewrap plate

Single-part order:

2607. 1 PZB + tiewrap plate

Mounting bracket with bore

2607. 2 PZB + tiewrap plate

Mounting bracket with pin

26...3PZ(B) Standard! (pivoting)

26...1PZ(B) (locking)

Moving end

Standard! (pivoting) 26...4PZ(B)

(locking) 26...2PZ(B)

Fixed end

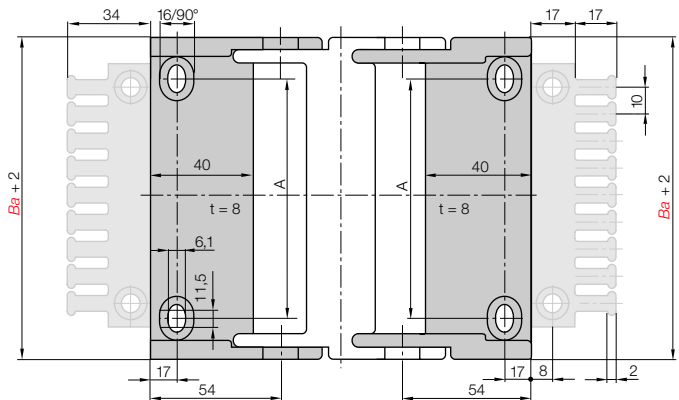

For E-Chain®	Part No. full set with tiewrap plate	Part No. tiewrap plate + 10 cable tiewraps	Part No. full set without tiewrap plate	Number of teeth	Dim. A [mm]
E26-Z26.07	▶ 2607. [] PZB	2607. [] PZBK1	2607. [] PZ	7	55
E26-Z26.2/45	▶ 2610. [] PZB	2610. [] PZBK1	2610. [] PZ	10	80
E26-Z26.3/45	▶ 2615. [] PZB	2615. [] PZBK1	2615. [] PZ	15	130

Please add the Part No. with the requested index - 34 for the pivoting configuration

e.g. 2607. [34] PZB or 12 for the locking configuration e.g. 2607. [12] PZB

For the preassembled mode please add the index A1...A4 e.g. 2607. [34] PZB A1

Strain relief for polymer mounting brackets (pivoting or locking)

The strain relief tiewrap plates can be directly snapped onto the mounting bracket. After bolting the mounting brackets to the machine, the strain relief tiewrap plates are also firmly connected to the base. They do not need to be bolted on separately. Cable tiewraps secured the tiewrap plate "teeth" and the cable provide proper strain relief and save time. **Details ▶ chapter 10**



Tiewrap plate	No. of teeth n	Dim. C [mm]	Dim. B [mm]	Center bore
3050.ZB	5	50	30	-
3075.ZB	7	75	55	-
3100.ZB	10	100	80	-
3115.ZB	11	115	95	-
3125.ZB	12	125	105	-
3150.ZB	15	150	130	-
3175.ZB	17	175	155	-
3200.ZB	20	200	180	+
3225.ZB	22	225	205	+
3250.ZB	25	250	230	+

(- = no / + = yes)

Tiewrap plate as individual part

As individual component screwed on or can be plugged in the mounting brackets. **Details ▶ chapter 10**

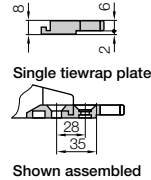
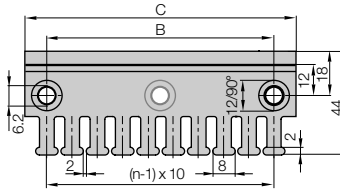

Cable tiewraps as individual part

Cable tiewraps 100 pieces/bag	Width x length	Max. Ø	Tensile strength
CFB.001	4,8 x 150 mm	36 mm	222 N



Other strain relief elements - optional ▶ chapter 10

Easy Chain®
Inner height: 36,5 mm

Phone +49- (0) 22 03-96 49-800
Fax +49- (0) 22 03-96 49-222



▶ chapter 10



▶ page 3.5



Price index



IPA Qualification Certificate:
Air Cleanless Class ISO Class 2
(at v = 1 m/s) upon request



UL94-V2
classifications



Torsional
motion possible



Special equipment:
Electrically conductive ESD/ATEX
version upon request



Just push the cables with your thumb
into the E-Chain® - and it's ready



When to use the Series E300/Z300:

- If filling is required without opening and closing lids
- If price is an issue
- If quiet operation is required



When not to use it:

- For applications with very high loads and long unsupported travel lengths
- Series 3400/3450/3480/3500
E2/000, page 5.126

- 1 Limited torsion tolerance
- 2 Large pins for long service life
- 3 Cable-friendly interior
- 4 Integrated strain relief option
- 5 "E" Series features split crossbar along the outer radius
- 6 "Z" Series features split crossbar along the inner radius
- 7 Dirt-repellent exterior
- 8 Very easy to fill
- 9 Interior separation possible
- 10 1-, 2- or 3-chamber system available
- 11 The patented push-button principle holds the links together

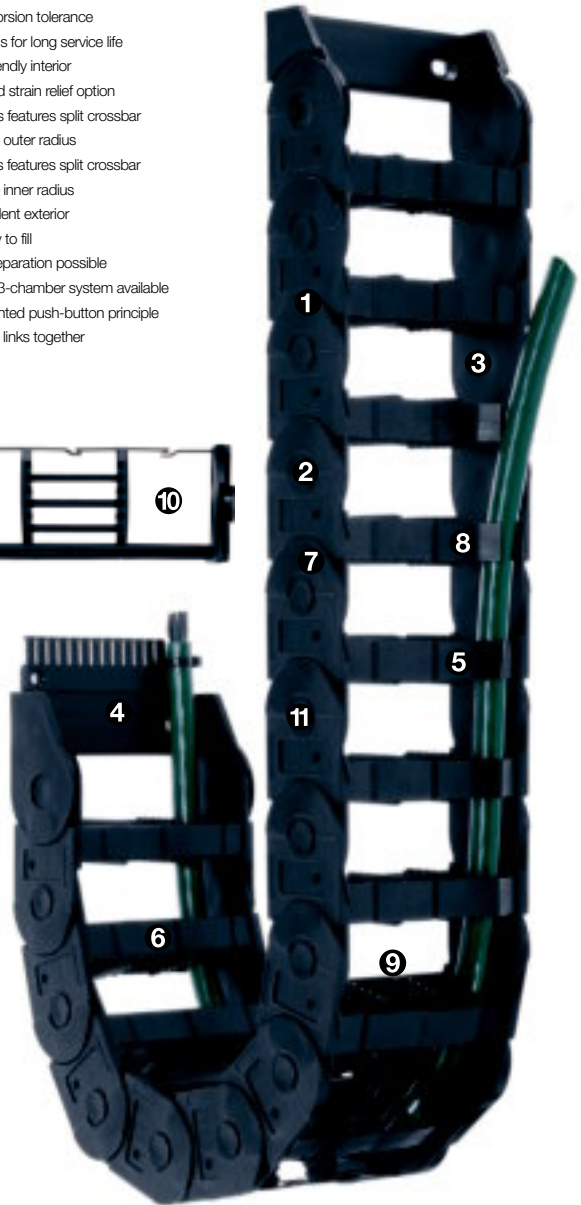

Order example complete E-Chain®

Please indicate chain-lengths or number of links Example: 1 m or 15 Links

1 m E300.075.100.0



E-Chain®

1 set 3075.34.PZB



Mounting bracket



Unsupported length

FL_G = with straight upper run

FL_B = with permitted sag

Further information ► **Design, page 1.12**

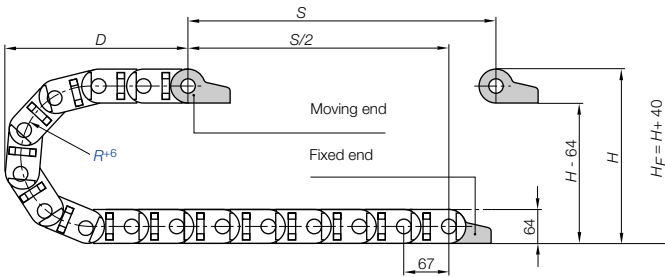
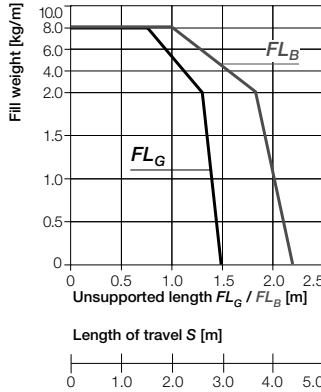
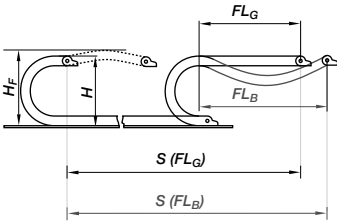

Pitch = 67 mm/link Links/m = 15 (1.005 mm) Chain length = $S/2 + K$

R	075	100	125	150	200	250	300
H + ⁵	215	265	315	365	465	565	665
D	150	200	225	250	300	350	400
K	400	500	650	725	875	1050	1225

- S = Length of travel
- R = Bending radius
- H = Nominal clearance height
- H_F = Required clearance height
- D = Overlength E-Chain® radius in final position
- K = $\pi \cdot R + \text{"safety"}$

Other installation methods

- Vertical, hanging ≤ 10 m
- Vertical, standing ≤ 1,5 m
- Side mounted, unSUPP. ≤ 0,5 m
- Rotary requires further calculation
- Unsupported length of upper run = upon request

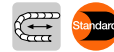

Short travels - unsupported

Unsupported E-Chains® feature positive camber over short travels. This must be accounted for when specifying the clearance height H_F. Please consult igus® if space is particularly restricted.

The required clearance height:
H_F = H + 40 mm
(with 2,5 kg/m fill weight)

Speed / acceleration FL_G	max. 20 [m/s] / max. 200 [m/s ²]
Speed / acceleration FL_B	max. 3 [m/s] / max. 6 [m/s ²]
Gliding speed / acceleration	max. 3 [m/s] / max. 10 [m/s ²]
Material (E-Chain®)- permitted temperature °C	igumid NB / -40° up to +80° C
Material (mounting brackets)* - permitted temperature °C	igumid G / -40° up to +120° C
Flammability class (E-Chain®), igumid NB	VDE 0304 IIC UL94 V2
Flammability class (mounting brackets), igumid G*	VDE 0304 IIC UL94 HB

*Available in igumid NB upon request, please consult igus® for delivery time

Technical Data



Details of material properties
► page 1.38

48,5

Easy Chain®
Inner height: 48,5 mm

Phone +49- (0) 22 03-96 49-800
Fax +49- (0) 22 03-96 49-222



► page 3.5

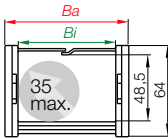

Series E300 - split crossbar along the outer radius

Part No.	Bi [mm]	Ba [mm]	R [mm]	Bending radii	Weight [kg/m]
E300.075. <input type="text"/> .0	75	95	075	100 125 150 200 250 300	≈ 1,60

Ba: pin dimension approx. 0,3 - 0,5 mm wider!

Supplement Part No. with required radius. Example: E300.075. .0

0 = standard color, other colors ▶ page 1.39 · Pitch = 67 mm/link - Links/m = 15

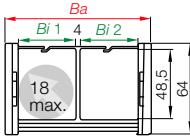

Series E300 - split crossbar along the outer radius with 2-chamber system

Part No.	Bi [mm]	Ba [mm]	R [mm]	Bending radii	Weight [kg/m]
E300.2/45. <input type="text"/> .0	48/48	120	075	100 125 150 200 250 300	≈ 1,78

Ba: pin dimension approx. 0,3 - 0,5 mm wider!

Supplement Part No. with required radius. Example: E300.2/45. .0

0 = standard color, other colors ▶ page 1.39 · Pitch = 67 mm/link - Links/m = 15

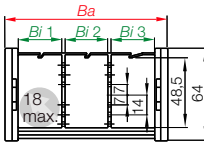

Series E300 - split crossbar along the outer radius with 3-chamber system

Part No.	Bi [mm]	Ba [mm]	R [mm]	Bending radii	Weight [kg/m]
E300.3/45. <input type="text"/> .0	47/46/47	170	075	100 125 150 200 250 300	≈ 1,92

Ba: pin dimension approx. 0,3 - 0,5 mm wider!

Supplement Part No. with required radius. Example: E300.3/45. .0

0 = standard color, other colors ▶ page 1.39 · Pitch = 1 m = 15 Links

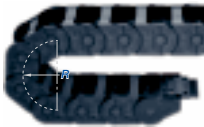

Part No. structure

E300.075. .0



Series Z300 - split crossbar along the inner radius

Part No.	Bi [mm]	Ba [mm]	R [mm]	Bending radii	Weight [kg/m]
Z300.075.□.0	75	95	075	100 125 150 200 250 300	≈ 1,60

Ba: pin dimension approx. 0,3 - 0,5 mm wider!

Supplement Part No. with required radius. Example: Z300.075.100.0

0 = standard color, other colors ► page 1.39 · Pitch = 67 mm/link · Links/m = 15

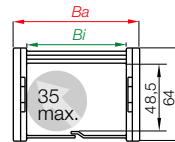

Series Z300 - split crossbar along the inner radius with 2-chamber system

Part No.	Bi [mm]	Ba [mm]	R [mm]	Bending radii	Weight [kg/m]
Z300.2/45.□.0	48/48	120	075	100 125 150 200 250 300	≈ 1,78

Ba: pin dimension approx. 0,3 - 0,5 mm wider!

Supplement Part No. with required radius. Example: Z300.2/45.100.0

0 = standard color, other colors ► page 1.39 · Pitch = 67 mm/link · Links/m = 15

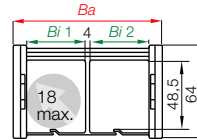

Series Z300 - split crossbar along the inner radius with 3-chamber system

Part No.	Bi [mm]	Ba [mm]	R [mm]	Bending radii	Weight [kg/m]
Z300.3/45.□.0	47/46/47	170	075	100 125 150 200 250 300	≈ 1,92

Ba: pin dimension approx. 0,3 - 0,5 mm wider!

Supplement Part No. with required radius. Example: Z300.3/45.100.0

0 = standard color, other colors ► page 1.39 · Pitch = 67 mm/link · Links/m = 15

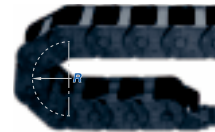
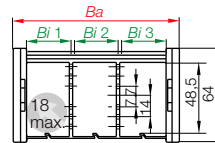

Part No. structure

Z300.075.100.0



Easy Chain®
Inner height: 48,5 mm

Phone +49- (0) 22 03-96 49-800
Fax +49- (0) 22 03-96 49-222

Easy Chain® | Series E300·Z300 | Accessories | Interior Separation

Optional shelving for E300.3/45 · Z300.3/45

- Shelving enables subdivision of the inner space of the E-Chain® Series E300.3/45 and Z300.3/45. Shelves are only used when a horizontal subdivision is required.
- In standard configurations, shelves are installed in every other link.

Shelves

unassembled	386.54
assembled	387.54

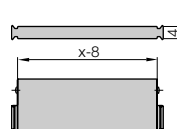
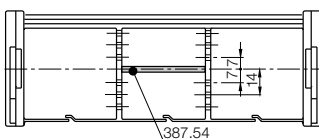

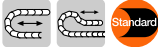

The Standard - option polymer - pivoting

- Recommended for unsupported and gliding applications
- Well suited for tight installation conditions
- Strain relief with detachable tiwrap plates
- Variable traverse angle for flexible assembly
- The twistability of the E-Chain® and the option to assemble the mounting brackets on the fixed end and/or the moving end, enable various installation options

Moving end with bore
(outer link) 3...3PZ(B)

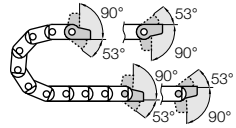

3...4PZ(B) Fixed end
with pin (inner link)



Possible installation conditions for assembled mounting brackets ▶ Order example "preassembled" below

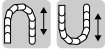

Option polymer - locking

- Recommended for unsupported and gliding applications
- At very high speed and/or acceleration
- If space is limited for height (the H_F measurement)
- The twistability of the E-Chain® and the option to assemble the mounting brackets on the fixed end and/or the moving end, enable various installation options

Moving end with bore
(outer link) 3...1PZ(B)

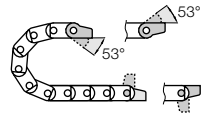

3...2PZ(B) Fixed end
with pin (inner link)

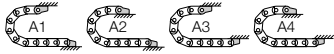

Possible installation conditions for assembled mounting brackets ▶ Order example "preassembled" below

Dimensions and order configurations

Strain relief is possible on the moving end and/or the fixed end.

Part No. structure (pivoting)

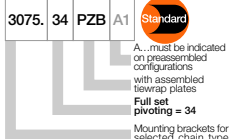

Full set, for both ends:

3075. 34 PZB +tiwrap plate

Single-part order:

3075. 3 PZB +tiwrap plate

Mounting bracket with bore

3075. 4 PZB +tiwrap plate

Mounting bracket with pin

Part No. structure (locking)

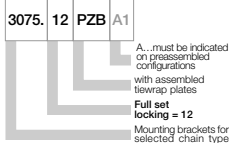

Full set, for both ends:

3075. 12 PZB +tiwrap plate

Single-part order:

3075. 1 PZB +tiwrap plate

Mounting bracket with bore

3075. 2 PZB +tiwrap plate

Mounting bracket with pin

3...3PZ(B) Standard! (pivoting)

3...1PZ(B) (locking)

Moving end

Standard! (pivoting) 3...4PZ(B)

(locking) 3...2PZ(B)

Fixed end

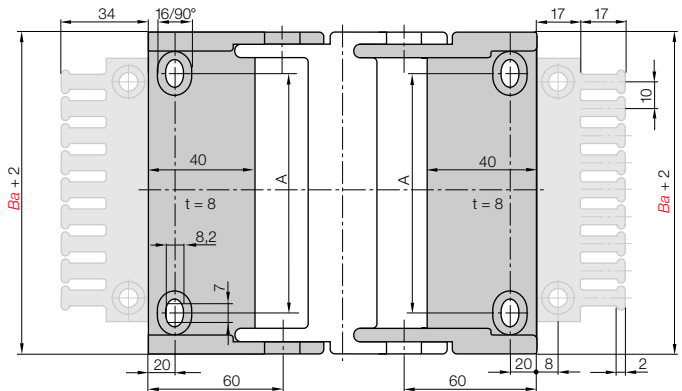

For E-Chain®	Part No. full set with tiwrap plate	Part No. tiwrap plate + 10 cable tiwraps	Part No. full set without tiwrap plate	Number of teeth	Dim. A [mm]
E300/Z300.075 ▶	3075. [] PZB	3075. [] PZBK1	3075. [] PZ	7	53
E300/Z300.2/45 ▶	3100. [] PZB	3100. [] PZBK1	3100. [] PZ	10	78
E300/Z300.3/45 ▶	3150. [] PZB	3150. [] PZBK1	3150. [] PZ	15	128

Please add the Part No. with the requested index - 34 for the pivoting configuration

e.g. 3075. 34 PZB or 12 for the locking configuration e.g. 3075. 12 PZB

For the preassembled mode please add the index A1 ... A4 e.g. 3075. 34 PZB A1

Strain relief for polymer mounting brackets (pivoting or locking)

The strain relief tiewrap plates can be directly snapped onto the mounting bracket. After bolting the mounting brackets to the machine, the strain relief tiewrap plates are also firmly connected to the base. They do not need to be bolted on separately. Cable tiewraps secured the tiewrap plate "teeth" and the cable provide proper strain relief and save time. **Details ▶ chapter 10**



Tiewrap plate	No. of teeth n	Dim. C [mm]	Dim. B [mm]	Center bore
3050.ZB	5	50	30	-
3075.ZB	7	75	55	-
3100.ZB	10	100	80	-
3115.ZB	11	115	95	-
3125.ZB	12	125	105	-
3150.ZB	15	150	130	-
3175.ZB	17	175	155	-
3200.ZB	20	200	180	+
3225.ZB	22	225	205	+
3250.ZB	25	250	230	+

(- = no / + = yes)

Tiewrap plate as individual part

As individual component screwed on or can be plugged in the mounting brackets. **Details ▶ chapter 10**

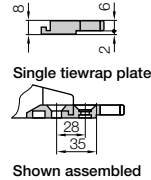
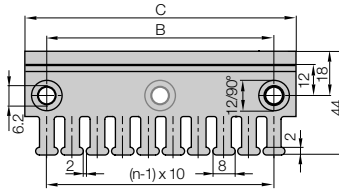

Cable tiewraps as individual part

Cable tiewraps 100 pieces/bag	Width x length	Max. Ø	Tensile strength
CFB.001	4,8 x 150 mm	36 mm	222 N



Other strain relief elements - optional ▶ chapter 10

Easy Chain®
Inner height: 48,5 mm

Phone +49- (0) 22 03-96 49-800
Fax +49- (0) 22 03-96 49-222



▶ chapter 10



▶ page 3.5



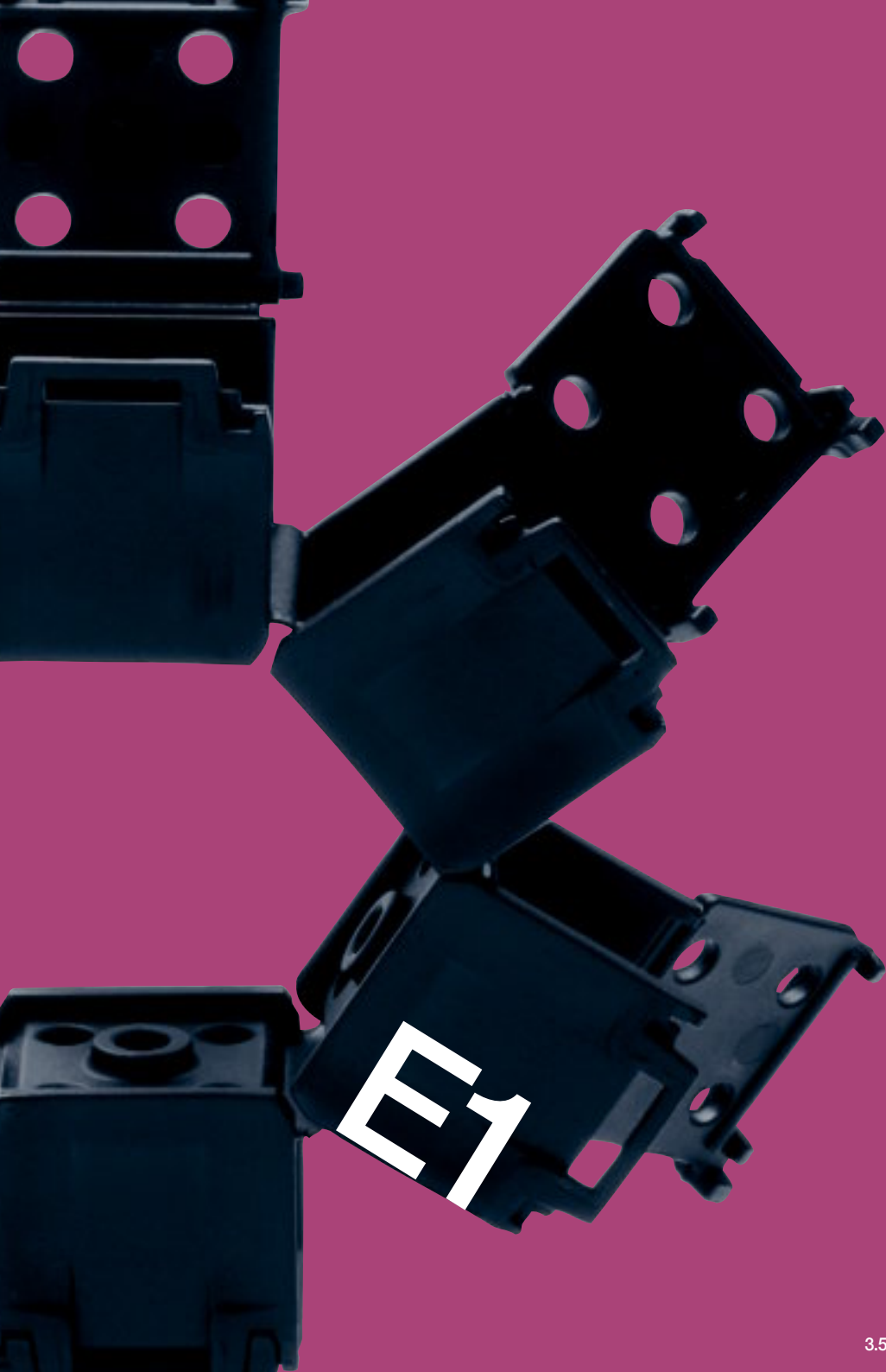

E1- Modular, one-piece strip design for simple applications

E1: E-Chain® modular, 1-piece strip designed for simple applications - The E1 design brings the benefits of an E-Chain® to applications, where this solution previously was too expensive. E1 is more economic for higher volumes, quicker to assemble and still offers great control and protection for moving cables. The igus®-System E1 is very cost effective for high volumes and is especially ideal for automotive applications.

Typical industries and applications

- Automotive
- Office Solutions and technology
- Automation
- Electric equipment
- Machine-building



UL94-V2
classifications

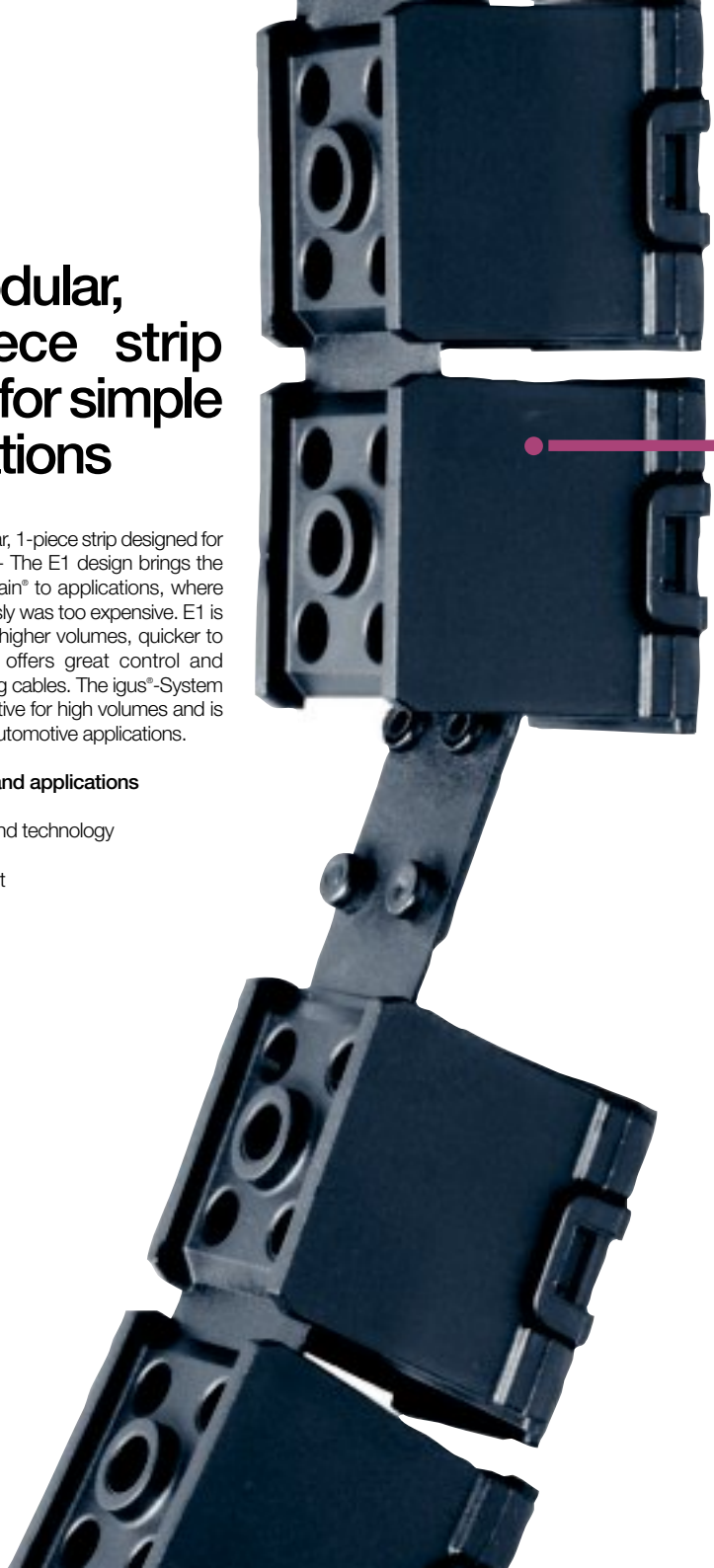

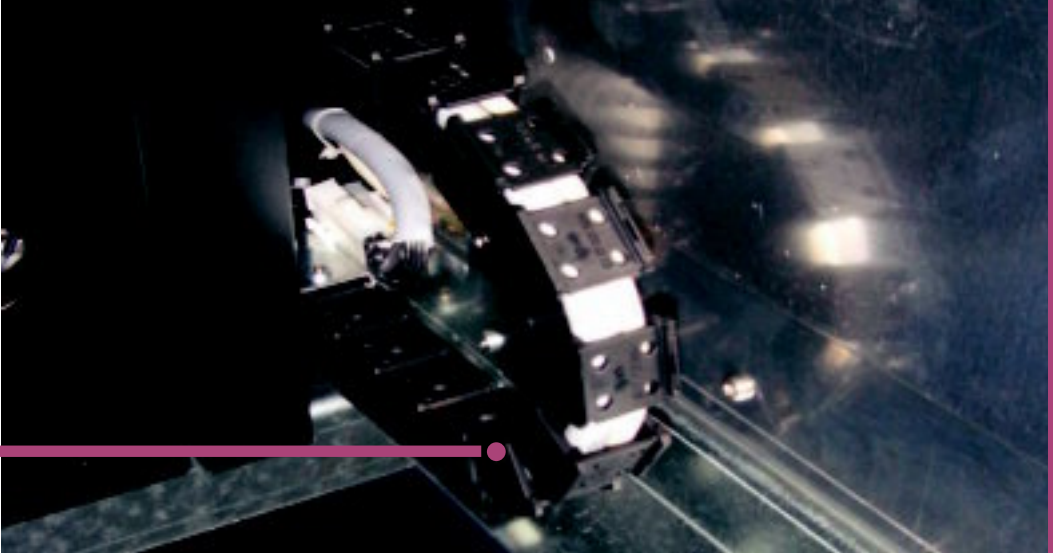

Harnessed igus® System E1 in a bottle deposit machine

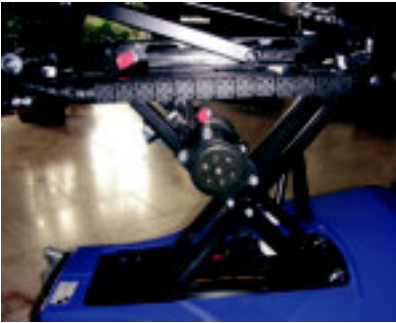

Series E1.17.021.028 in an electric wheelchair -
cably supply on the scissors lifting system



The igus®-System E1 is very cost-effective at high
quantities and ideal for automotive applications



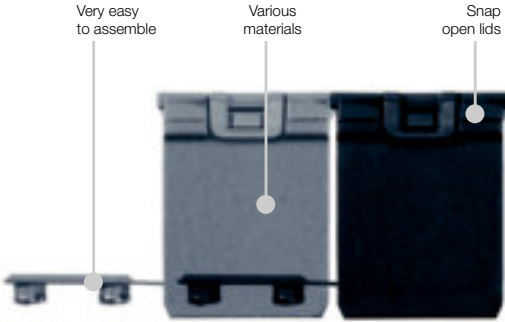

Modular, 1-piece strip design for simple applications

- Economic solution for high volumes
- A universal and easily adaptable E-Chain® concept
- E1: E-Chain® on one strip
- Easy shortening/lengthening through molded-on, modular strip
- Easy to snap open
- Strip connectors
- Easy fixation at each end
- Various materials available
- You can find more technical data about the material, chemical resistance, temperatures ► **chapter design, from page 1.38**

Selection table

Series	Inner height <i>hi</i> [mm]	Inner width <i>Bi</i> [mm]	Outer width <i>Ba</i> [mm]	Outer height <i>ha</i> [mm]	Bending radius <i>R</i> [mm]	Length part [mm]	Page
E1.10.013.	10	13	16,5	15,5	18	200	3.64
E1.17.021.	17	21	26	25	28	255	3.64
E1.17.031.	17	31	36	25	28	204	3.64
E1.17.044.	17	44	49	25	28	255	3.64
E1.20.015.	20	15	22	27	28	250	3.64



System E1 - E-Chain® on one strip - snap-open along outer radius

To shorten | System E1



System E1 - E-Chain® on one strip - easy to shorten...

To lengthen | System E1



.. and to lengthen



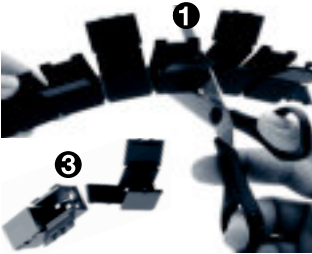

Price index

UL94-V2
classificationsSystem E1 - E-Chain® on one strip -
easy to shorten and to lengthen**When to use the Series E1:**

- If simple filling is required
- If an economical E-Chain® is required
- If small assembly cost is required
- For lower duty or cycle life

**When not to use it:**

- High load applications
 - ▶ Easy Chain®, this chapter
 - ▶ Zipper, chapter 4
- High cycle applications
 - ▶ Easy Chain®, this chapter
 - ▶ Zipper, chapter 4

- ❶ Easy to shorten - separation at each segment
- ❷ Very easy to fill because of snap-open lids
- ❸ Easy to lengthen - strips can simply be snapped together
- ❹ Easy fastening through strip bore each link
- ❺ Low-price E-Chain®
- ❻ Different materials and colors available upon request
- ❼ Compact design with smooth outer contour
- ❽ Strain relief option (clip-on bracket)
- ❾ All lids snap open to the same side for easier, (Except E1.20.40 - to open from both sides), possibly automated closing

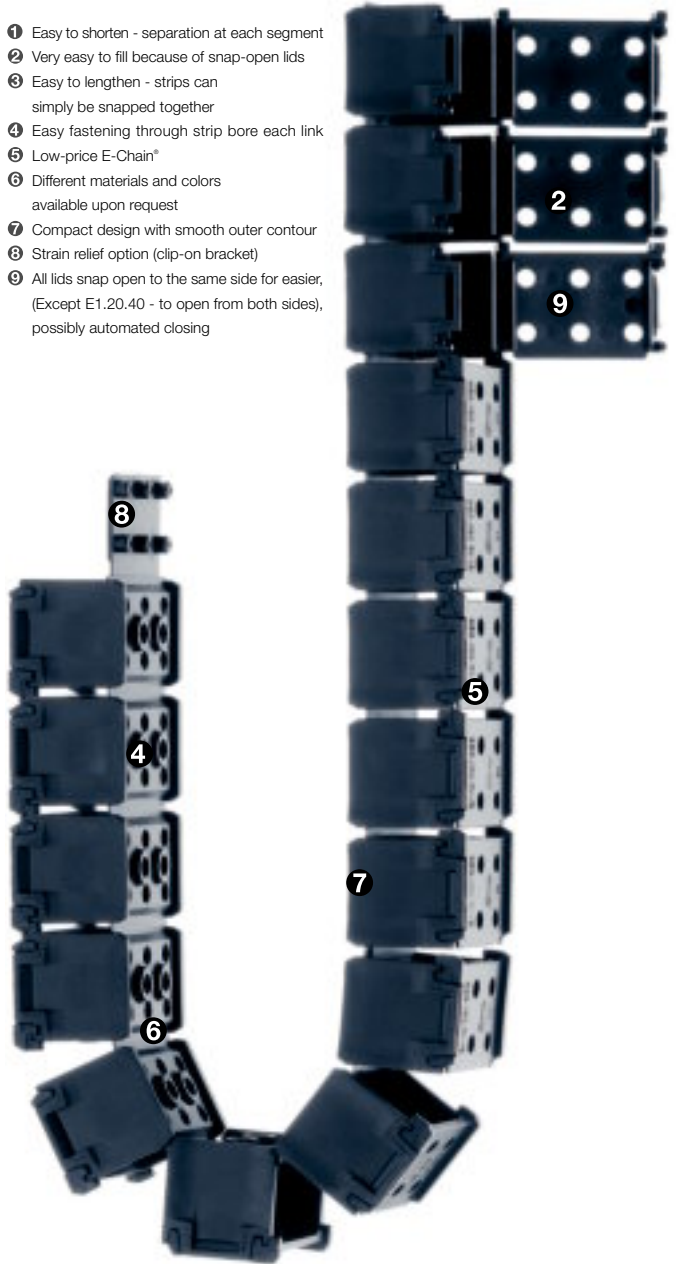
**Order example complete E-Chain®**

Please indicate chain-lengths or number of links Example: 1 Band = 250 mm of length

1 m E1.17.021.028.0 (= 4 x 255 mm Band)

**E-Chain®**

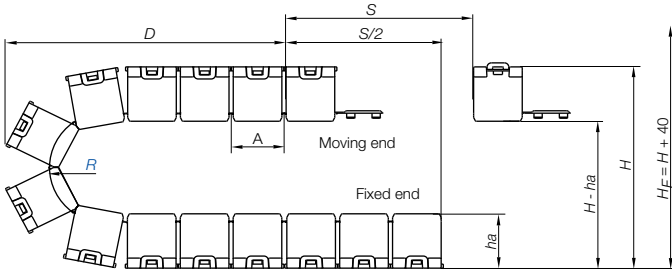

- S = Length of travel
- R = Bending radius
- H = Nominal clearance height
- H_F = Required clearance height
- D = Overlength E-Chain* radius in final position
- K = π · R + "safety"

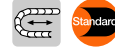

Short travels - unsupported

Unsupported E-Chains* feature positive camber over short travels. This must be accounted for when specifying the clearance height H_F. Please consult igus* if space is particularly restricted.

Pitch = see Dim. A Length part = see Dim. B Chain length = $S/2 + K$

Bending radius for Series:		E1.10	E1.17	E1.20
R		018	028	028
H		62	92	92
D		66	76	76
K		100	120	120

The required clearance height is H_F = H + 40 mm · More radii upon request!

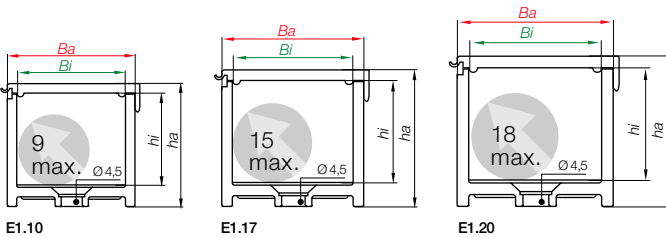

Product Range - Series E1 - snap-open along outer radius

Part No.	Bi [mm]	Ba [mm]	hi [mm]	ha [mm]	R [mm]	Bending radii	A [mm]	B [mm]
E1.10.013.□.0	13	16,5	10	15,5	018		20	200
E1.17.021.□.0	21	26	17	25	028		25,5	255
E1.17.031.□.0	31	36	17	25	028		25,5	204
E1.17.044.□.0	44	49	17	25	028		25,5	255
E1.20.015.□.0*	15	22	20	27	028		25	250

* E1.20.015 - Lids to open reciprocal

Supplement Part No. with required radius. Example: E1.17.021.028,0

0 = standard color, other colors ▶ page 1.39 · Pitch = 25 mm/link · Links/m = 40

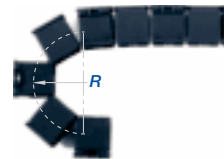

Part No. structure

E1.17.021.028,0

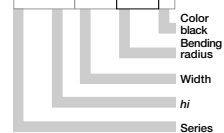

System E1
Inner height: 10, 17, 20 mm

Phone +49- (0) 22 03-96 49-800
Fax +49- (0) 22 03-96 49-222





SnapChain





Price index



iF-Design-Award
for SnapChain-Design

Typical industries and applications

- Switch cubicle construction
- Electrical equipment
- Computer cubicles
- Office furniture
- Wherever cables are moved now and then



- ① Fit cable assemblies quickly in bunches
- ② Adjust and change loops at any time
- ③ Well-suited to short lengths, ideally 5 - 10 links
- ④ Favorable alternative to complex hinged cable trays
- ⑤ Version TE can be opened along outer radius - Version TZ along inner radius
- ⑥ Elegant design
- ⑦ Can be bent in 1 or 2 directions
- ⑧ Available in 2 sizes



When to use the SnapChain Series :

- If simple filling is required
- If an economical e-chain is required
- If small assembly cost is required
- If an easy solution is required
- For minor number of travels



When not to use it:

- High load applications
 - ▶ Easy Chain®, this chapter
 - ▶ Zipper, chapter 4
- High cycle applications
 - ▶ Easy Chain®, this chapter
 - ▶ Zipper, chapter 4



Order example complete E-Chain®

Please indicate chain-lengths or number of links Example: 1 m or 18 links

1 m TE26.120.100.0



E-Chain®

SnapChain - TE14 / TZ14 - to be opened

Part No.	R [mm]	Bending radii					
TE14.50.□.0*	028	038	048	075	100	125	
TZ14.50.□.0	028	038	048	075	100	125	

*Available as RBR (Reverse bending radius) Part No. TE14.50.Radius/Radius

Supplement Part No. with required radius. Example: TE14.50.100.0

0 = standard color, other colors ▶ page 1.39 · Pitch = 30,5 mm/link - Links/m = 33

Pitch = 30,5 mm

Links/m = 33 (1.006,5 mm)

Chain length = $s/2 + K$

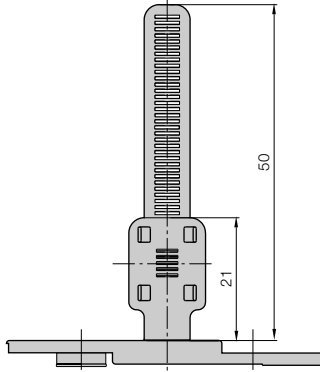
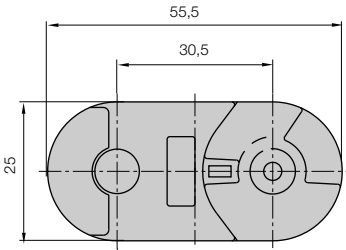

Part No. structure

TE14.	50.	100.0
-------	-----	-------

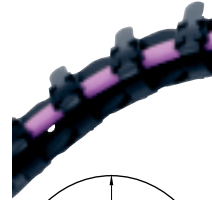

Cable package max.: 18 mm

SnapChain - TE26 / TZ26 - to be opened

Part No.	R [mm]	Bending radii					
TE26.120.□.0*	063	075	100	125	150	200	
TZ26.120.□.0	063	075	100	125	150	200	

*Available as RBR (Reverse bending radius) Part No. TE26.120.Radius/Radius

Supplement Part No. with required radius. Example: TE26.120.100.0

0 = standard color, other colors ▶ page 1.39 · Pitch = 56 mm/link - Links/m = 18

Pitch = 56 mm

Links/m = 18 (1.008 mm)

Chain length = $s/2 + K$

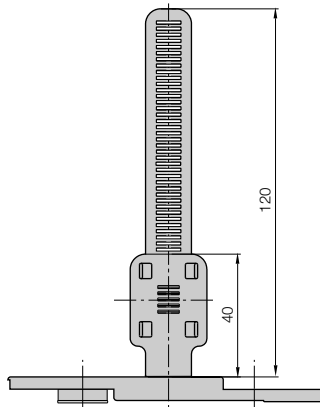
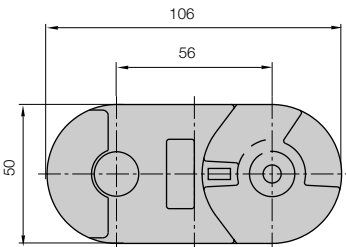

Part No. structure

TE26.	120.	100.0
-------	------	-------

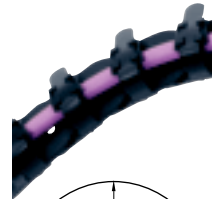

Cable package max.: 47 mm



Zipper

zip-open principle

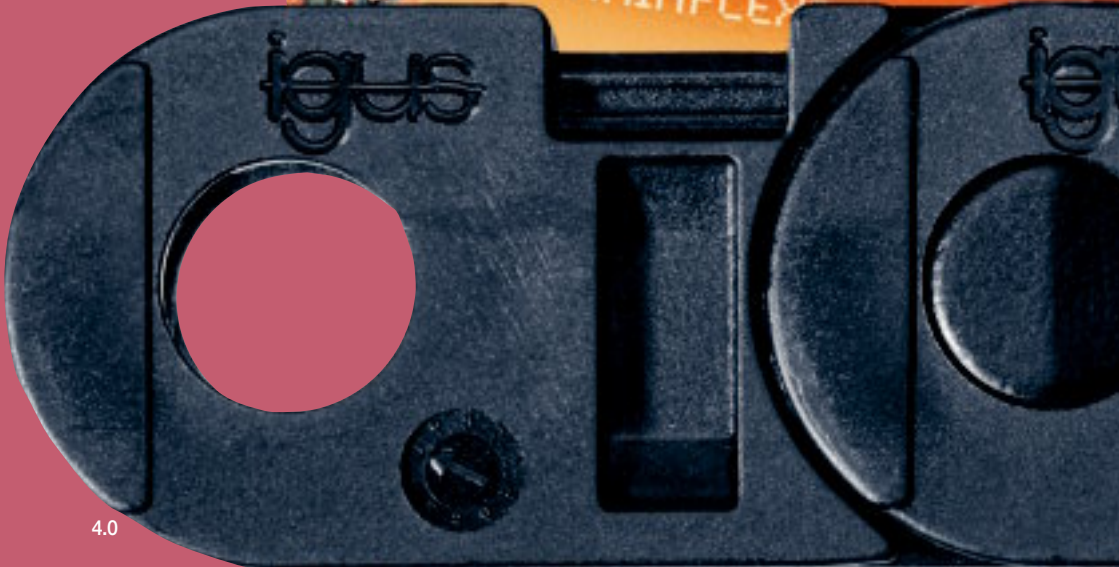

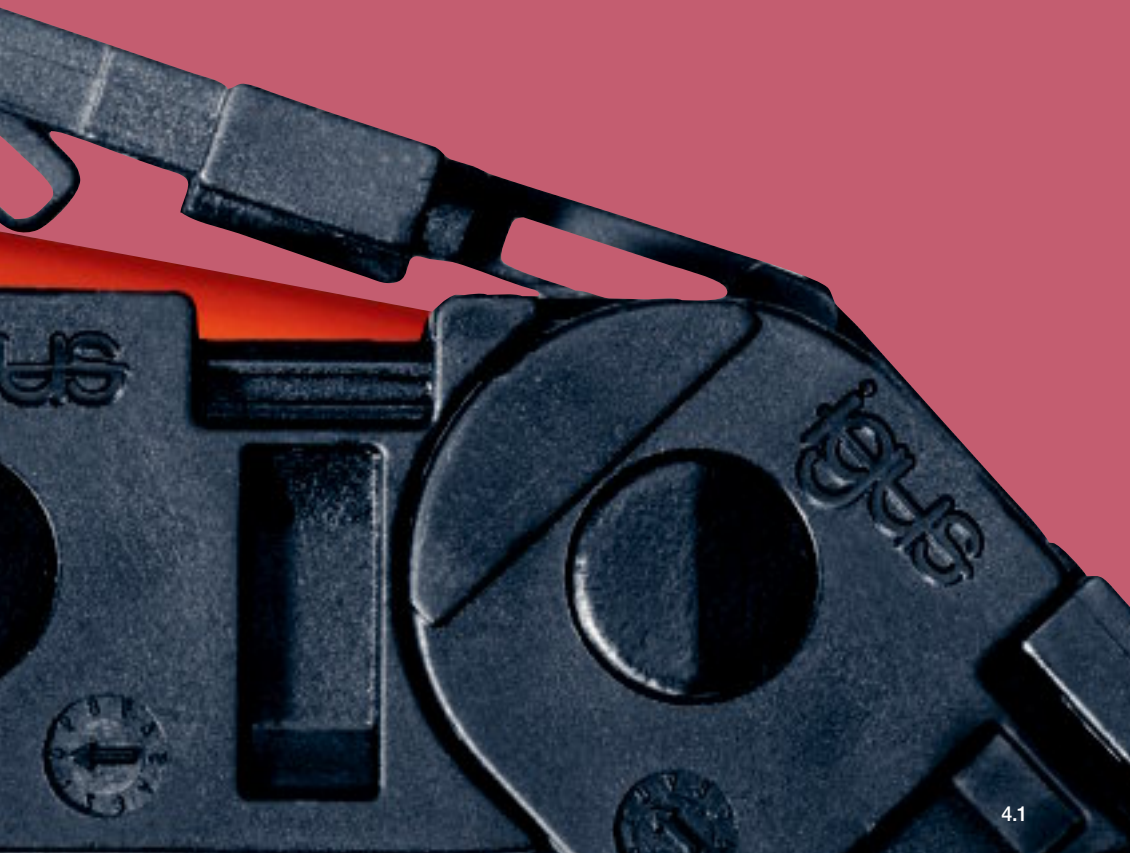



Zipper - zip fastening E-Chains® with iF-Design Award

Lightning-fast opening and closing with Zipper E-Chains® and E-Tubes
"Zipper" E-Chains® convince in practicality and performance. The "Zipper" function makes them a very useful product to reduce assembly time. The small pitch, the tough-elastic zipper-band, and the sturdy link work well in high-acceleration environments. The "Zipper" Series is one of the most popular E-Chain® Series in demanding applications.

Typical industries and applications

- Pick & place robots
- Semi-conductor machines
- Linear motors, actuators
- Measuring equipment
- Machine tools (Zipper E-Tube)



Cleanroom Class 1 (ISO class 3) for Zipper Series 15, tested by the Dryden Engineering Company, California



UL94-V2 classifications upon request



iF-Design Award Winner



Low-noise



Fast Opening and Closing with "Zipper"

igus® E-Chain® Series 17
on an X-Y table.
Acceleration: 100 m/s²

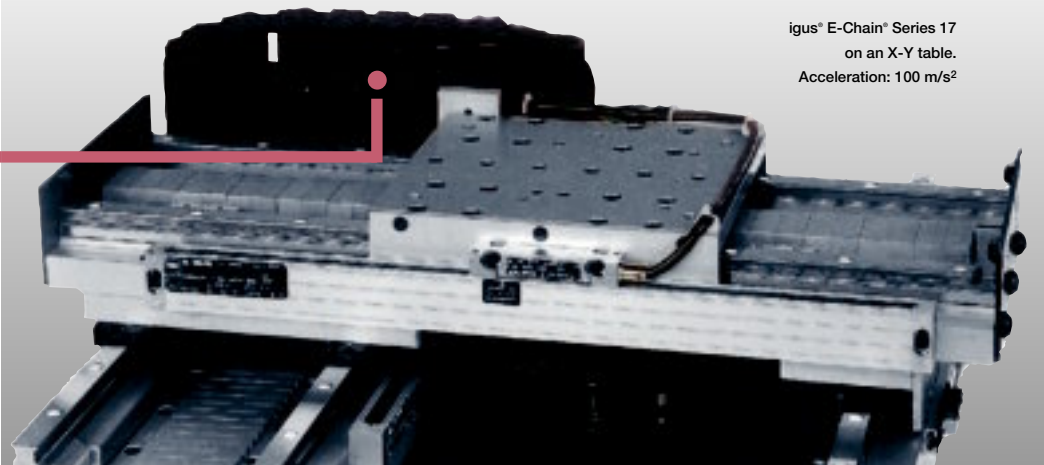

Lightning fast opening and closing with "Zipper"

- Reduced assembly-time
- Zipper-like design for quick opening and closing of lids
- Zipper lids can be separated and joined at each chain link
- Small pitch for low noise and smooth operation
- High accelerations: 100 m/s² and more are possible
- Interior separation possible for larger versions (Series 15 and 17)

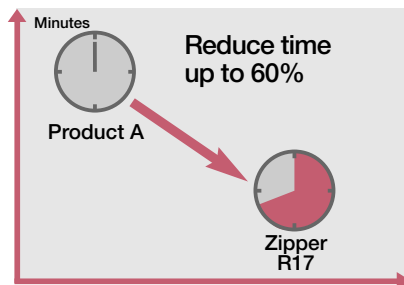

Opening of a 1m Chain. We can present you with more Details about this and other tests

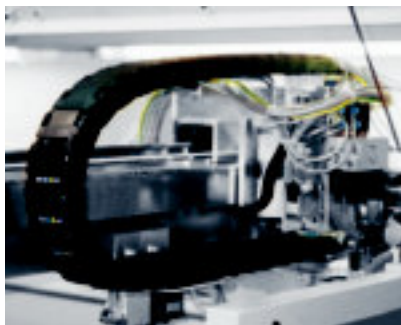

igus® E-Chain® Series 15 Zipper in automatic equipment - reduce assembly time

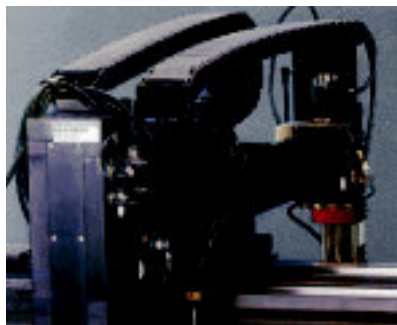

Series 15 with acceleration of 100 m/s² on pick-and-place robots, low noise

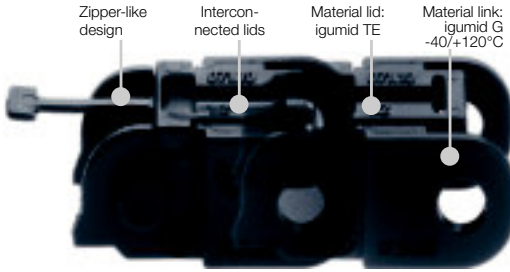

Zipper E-Chains®

- Reduced assembly-time:
 - Zipper-like design for quick opening and closing of lids
- Zipper lids can be separated and joined at each chain link
- Small pitch for low noise, smooth operation
- High acceleration: 100 m/s² and more
- Interior separation possible for larger versions
- You can find more technical data about the material, chemical resistance, temperatures ► [chapter design, from page 1.38](#)

Selection table

Series	Inner height <i>hi</i> [mm]	Inner width <i>Bi</i> [mm]	Outer width <i>Ba</i> [mm]	Outer height <i>ha</i> [mm]	Bending radius <i>R</i> [mm]	Unsupported length max. [m]	Page
047	9,0	10 - 16	16,0 - 22,0	12,5	18 - 38	0,40	4.6
07	10,3	6 - 64	12,5 - 71,0	15,0	18 - 38	0,55	4.10
09	15,0	10 - 50	18,2 - 58,2	19,3	28 - 48	1,00	4.14
15	17,0	15 - 100	26,0 - 113,0	24,0	38 - 180	1,20	4.18
17	32,0	15 - 100	26,0 - 113,0	39,0	63 - 125	1,00	4.24

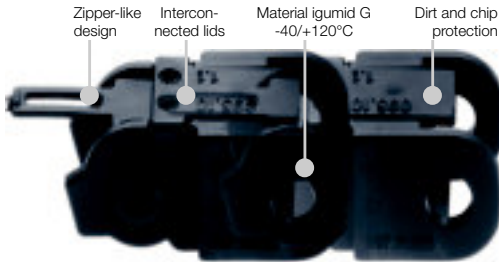

Zipper E-Tubes against chips and dirt

- Fully enclosed E-Tube with zipper opening mechanism
- Protection against dirt and chips
- Superfast opening of interconnected lids
- Modular design - tool-free lengthening and shortening
- Small pitch for low noise, smooth operation, high acceleration
- You can find more technical data about the material, chemical resistance, temperatures ► [chapter design, from page 1.38](#)

Selection table

Series	Inner height <i>hi</i> [mm]	Inner width <i>Bi</i> [mm]	Outer width <i>Ba</i> [mm]	Outer height <i>ha</i> [mm]	Bending radius <i>R</i> [mm]	Unsupported length max. [m]	Page
R07	10,3	10 - 50	16,5 - 57,0	15,0	38 - 48	0,55	4.28
R09	15,0	10 - 50	18,2 - 58,2	19,3	48 - 100	1,00	4.32
R15	17,0	25 - 80	36,0 - 94,0	24,0	63 - 180	1,20	4.36
R17	32,0	15 - 63	26,0 - 76,0	39,0	63 - 125	1,20	4.42

Assembling | Zipper



1 Push and click



2 Snap lids together



3 Position and...



4 ...push and snap

Separating | Zipper



1 Zipp - upward . All lids fit like a "Zipper"



2 Separate lids



3 Release side-link



4 Twist and pull apart



● ● ● Price index

Clean-Room

Upon request: Cleanroom Class 1 (ISO class 3) tested by the Dryden Engineering Company, California

UL

UL94-V2 classifications upon request



Low-noise



"Zipper-fast" opening and closing



When to use the Series 047:

- If fast, zipper-like accessibility to cables is required
- If quiet operation is required
- If aesthetic design is required
- If excellent service life is required
- If cost is a factor



When not to use it:

- If easy filling without opening and closing is required
 - ▶ Series E04 Easy Chain®, page 3.10



Order example complete E-Chain®

Please indicate chain-lengths or number of links **Example: 1 m or 77 Links**

1 m **047.10.038.0**



E-Chain®

1 set **0450.10.12**



Mounting bracket



Unsupported length

FL_G = with straight upper run

FL_B = with permitted sag

Further information ► Design, page 1.12

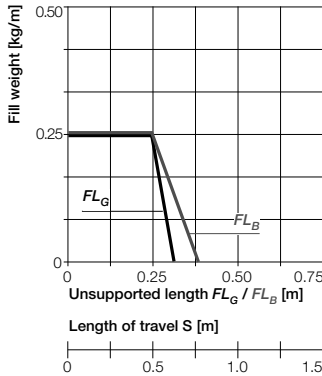
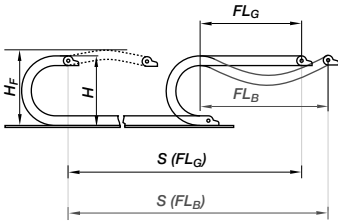

- S = Length of travel
- R = Bending radius
- H = Nominal clearance height
- H_F = Required clearance height
- D = Overlength E-Chain® radius in final position
- $K = \pi \cdot R + \text{"safety"}$

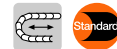
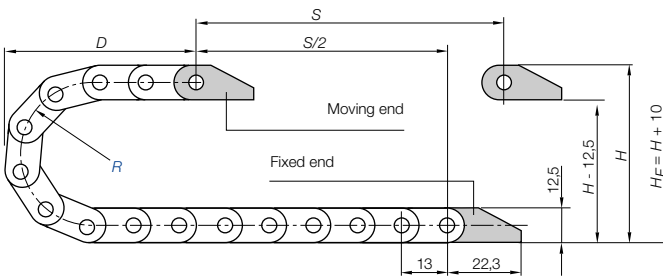

Short travels - unsupported

Unsupported E-Chains® feature positive camber over short travels. This must be accounted for when specifying the clearance height H_F . Please consult igus® if space is particularly restricted.

Pitch = 13 mm/link Links/m = 77 (1.001 mm) Chain length = $S/2 + K$

R	018	028	038
H	52	72	92
D	45	55	65
K	100	140	160

The required clearance height:
 $H_F = H + 10$ mm
 (with 0.2 kg/m fill weight)

Speed / acceleration FL_G	max. 20 [m/s] / max. 200 [m/s ²]
Speed / acceleration FL_B	max. 3 [m/s] / max. 6 [m/s ²]
Gliding speed / acceleration (maximum)	max. 10 [m/s] / max. 50 [m/s ²]
Material - permitted temperature °C	igumid G / -40° to +120° C
Flammability class, igumid G	VDE 0304 IIC UL94 HB

Technical Data



Details of material properties
 ► page 1.38



Zipper E-Chains®
 Inner height: 9 mm

Phone +49- (0) 22 03-96 49-800
 Fax +49- (0) 22 03-96 49-222



► page 4.5

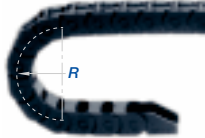
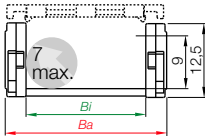

Part No. structure

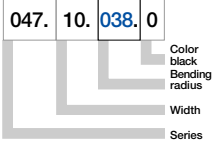

Series 047 E-Chain® - zip-open along outer radius

Part No.	Bi [mm]	Ba [mm]	R [mm]	Bending Radii	Weight [kg/m]
047.10.□.0	10	16	018	028 038	≈ 0,10
047.16.□.0	16	22	018	028 038	≈ 0,11

Supplement part no. with required radius (R) Example: 047.10.038.0

0 = standard color, other colors ▶ page 1.39 · Pitch = 13 mm/link - Links/m = 77





Polymer, one-piece

- One-piece mounting bracket
- Corrosion-resistant
- Available preassembled
- Various installation conditions possible

Moving end with bore
(outer link) 0450...1(PZ)

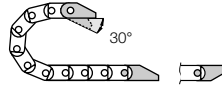

0450...2 (PZ) Fixed end
with pin (inner link)



Possible installation conditions for assembled mounting brackets ▶ Order example "preassembled" below

0450...1(PZ)
Moving end

0450...2(PZ)
Fixed end

Dimensions and order configurations

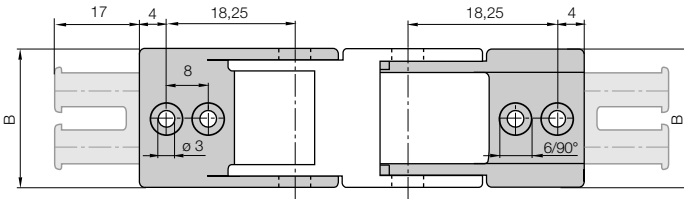

For E-chain®	Part No. full set with tiewrap plate	Part No. full set without tiewrap plate	Number of teeth	Dim. B [mm]
047.10. ▶	0450.10. <input type="text" value="12"/> PZ	0450.10. <input type="text" value="12"/>	1	16
047.16. ▶	0450.16. <input type="text" value="12"/> PZ	0450.16. <input type="text" value="12"/>	2	22

Part No. structure

0450. 10. 12 PZ A2

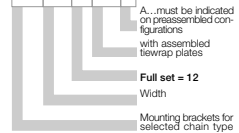

Full set, for both ends:

Single-part order:

Mounting bracket with bore

Mounting bracket with pin

For the preassembled mode please add the index and Example: 0450.10.



Quicksnap - the complete, detachable mounting unit, available upon request



Quickfix - mounting bracket with dowel, available upon request

Additional Features





Price index



Upon request: Cleanroom Class 1
(ISO class 3) tested by the Dryden
Engineering Company, California



UL94-V2 classifications
upon request



Low-noise



"Zipper-fast" opening and closing

**When to use the Series 07:**

- If fast, zipper-like accessibility to cables is required
- If quick, easy insertion of cables with preassembled connectors is required
- If quieter operation is required
- If aesthetic design is required
- At high acceleration and travel speed

**When not to use it:**

- If a cheaper, openable E-Chain® is required,
 - ▶ Series B07 E2 micro, page 5.30
- If cable installation without opening lids is possible
 - ▶ Series E06 Easy Chain®, page 3.20
- If a closed tube system is required
 - ▶ Series R07 Zipper, page 4.28

- ① "Zipper-fast" opening and closing
- ② Small pitch for low-noise, smooth operation
- ③ For high acceleration
- ④ Zipper lids can be separated and joined at each chain link
- ⑤ Light weight
- ⑥ Mounting bracket with integrated strain relief
- ⑦ Also available as "Zipper" E-Tube Series R07 ▶ page 4.28
- ⑧ Cheaper, openable E-Chain®, Series B07 E2 micro ▶ page 5.30

**Order example complete E-Chain®**Please indicate chain-lengths or number of links **Example: 1 m or 50 links**

1 m 07.20.038.0



E-Chain®

1 set 060.20.12PZ



Mounting bracket



Unsupported length

FL_G = with straight upper run

FL_B = with permitted sag

Further information ► Design, page 1.12

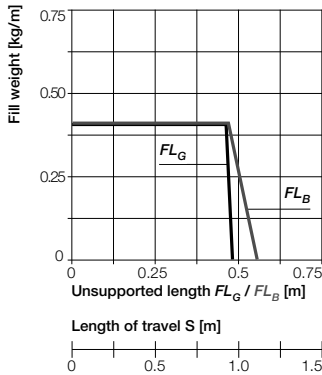
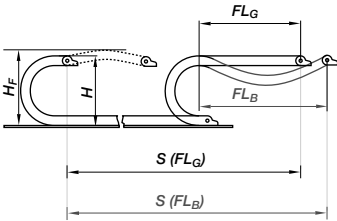

- S = Length of travel
- R = Bending radius
- H = Nominal clearance height
- H_F = Required clearance height
- D = Overlength E-Chain® radius in final position
- $K = \pi \cdot R + \text{"safety"}$

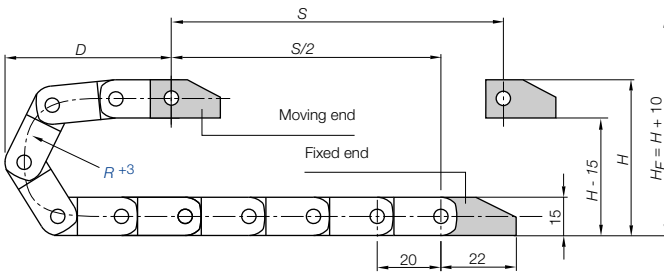

Pitch = 20 mm/link Links/m = 50 (1.000 mm) Chain length = $S/2 + K$

R	018	028	038
H	52	72	92
D	45	55	65
K	100	140	160

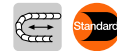

Short travels - unsupported

Unsupported E-Chains® feature positive camber over short travels. This must be accounted for when specifying the clearance height H_F . Please consult igus® if space is particularly restricted.

The required clearance height:
 $H_F = H + 10 \text{ mm}$
 (with 0.2 kg/m fill weight)

Speed / acceleration FL_G	max. 20 [m/s] / max. 200 [m/s ²]
Speed / acceleration FL_B	max. 3 [m/s] / max. 6 [m/s ²]
Gliding speed / acceleration (maximum)	max. 10 [m/s] / max. 50 [m/s ²]
Material - permitted temperature °C	igumid G / -40° to +120° C
Flammability class, igumid G	VDE 0304 IIC UL94 HB

Technical Data



Details of material properties
 ► page 1.38



Zipper E-Chains®
 Inner height: 10,3 mm

Phone +49- (0) 22 03-96 49-800
 Fax +49- (0) 22 03-96 49-222



► page 4.5

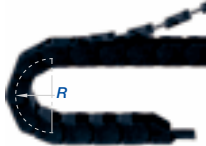
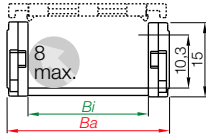

Part No. structure

07. 20. 038. 0

Color
black
Bending
radius
Width
Series

Series 07 E-Chain® - zip-open along outer radius

Part No.	Bi [mm]	Ba [mm]	R [mm]	Bending Radii		Weight [kg/m]
07.06.□.0	06	12,5	018	028	038	~ 0,13
07.10.□.0	10	16,5	018	028	038	~ 0,14
07.16.□.0	16	22,5	018	028	038	~ 0,16
07.20.□.0	20	27	018	028	038	~ 0,17
07.30.□.0	30	37	018	028	038	~ 0,20
07.40.□.0	40	47	018	028	038	~ 0,23
07.50.□.0	50	57	018	028	038	~ 0,26
07.64.□.0	64	71	018	028	038	~ 0,30

Supplement part no. with required radius (R) Example: 07.20.□038□.0

0 = standard color, other colors ► page 1.39 · Pitch = 20 mm/link - Links/m = 50





Polymer, one-piece

- One-piece mounting bracket
- Corrosion-resistant
- Available preassembled
- Inner and outer attachment possible
- Available with or without integrated strain relief tiwrap plates

Moving end with bore
(outer link) 060...1(PZ)

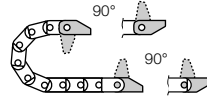

060...2(PZ) Fixed end
with pin (inner link)

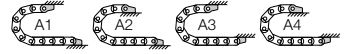

Possible installation conditions for assembled mounting brackets ▶ Order example "preassembled" below

060...1(PZ)

Moving end

060...2(PZ)

Fixed end

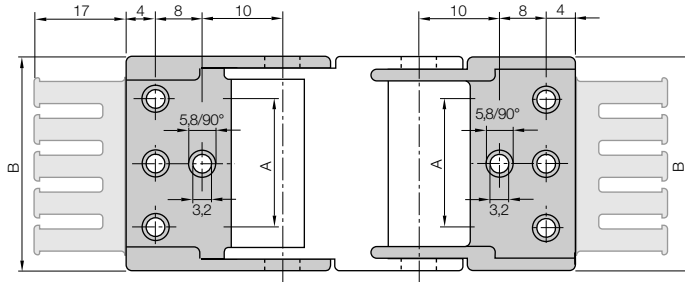

060.06.12 - 060.20.12: center bores only

060.30.12 - 060.64.12: outer bores only

For E-chain®	Part No. full set with tiwrap plate	Part No. full set without tiwrap plate	Number of teeth	Dim. A [mm]	Dim. B [mm]
07.06. ▶	060.06. 12 PZ	060.06. 12	1	-	12,5
07.10. ▶	060.10. 12 PZ	060.10. 12	1	-	16,5
07.16. ▶	060.16. 12 PZ	060.16. 12	2	-	22,5
07.20. ▶	060.20. 12 PZ	060.20. 12	2	-	27,0
07.30. ▶	060.30. 12 PZ	060.30. 12	3	22	37,0
07.40. ▶	060.40. 12 PZ	060.40. 12	4	32	47,0
07.50. ▶	060.50. 12 PZ	060.50. 12	5	42	57,0
07.64. ▶	060.64. 12 PZ	060.64. 12	6	56	71,0

For the preassembled mode please add the index **A1** ... **A4** Example: 060.06. 12 PZ **A1**

Dimensions and order configurations

Strain relief is possible on the moving end and/or the fixed end.

Part No. structure

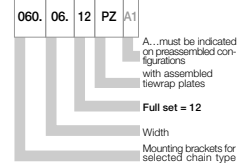

Full set, for both ends:

060.06. 12 PZ +tiwrap plate

Single-part order:

060.06. 1 PZ +tiwrap plate

Mounting bracket **with bore**

060.06. 2 PZ +tiwrap plate

Mounting bracket **with pin**



Quicksnap - the complete, detachable mounting unit, available upon request

Quickfix - mounting bracket with dowel, available upon request

Additional Features

Phone +49- (0) 22 03-96 49-800
Fax +49- (0) 22 03-96 49-222





Price index



Upon request: Cleanroom Class 1
(ISO class 3) tested by the Dryden
Engineering Company, California



UL94-V2 classifications
upon request



Low-noise



"Zipper-fast" opening and closing



When to use the Series 09:

- If fast, zipper-like accessibility to cables is required
- If quick, easy insertion of cables with preassembled connectors is required
- If quiet operation is required
- If aesthetic design is required
- At high acceleration and travel speed



When not to use it:

- If a cheaper, openable E-Chain® is required,
 - ▶ Series B09 E2 micro, page 5.38
- If cable installation without opening lids is possible
 - ▶ Series E08 Easy Chain®, page 3.28
- If a closed tube system is required
 - ▶ Series R09, page 4.32

- 1 "Zipper-fast" opening and closing
- 2 For high acceleration
- 3 Small pitch for low-noise, smooth operation
- 4 Zipper lids can be separated and joined at each chain link
- 5 Light weight
- 6 Mounting bracket with integrated strain relief
- 7 Also available as "Zipper" E-Tube, Series R09 ▶ page 4.32
- 8 Cheaper, openable E-Chain®, Series B09 E2 micro ▶ page 5.38



Order example complete E-Chain®

Please indicate chain-lengths or number of links Example: 1 m or 50 links

1 m 09.20.038.0



E-Chain®

1 set 080.20.12PZ



Mounting bracket



Unsupported length

FL_G = with straight upper run

FL_B = with permitted sag

Further information ► Design, page 1.12

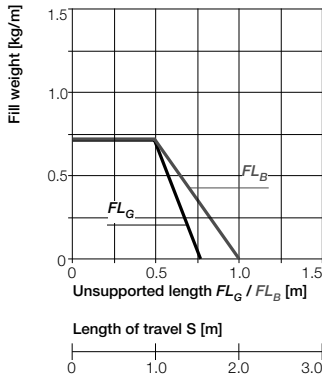
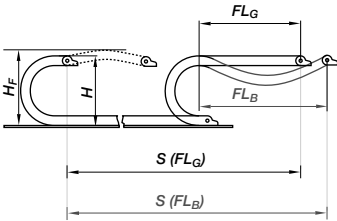

- S = Length of travel
- R = Bending radius
- H = Nominal clearance height
- H_F = Required clearance height
- D = Overlength E-Chain® radius in final position
- $K = \pi \cdot R + \text{"safety"}$

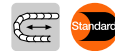
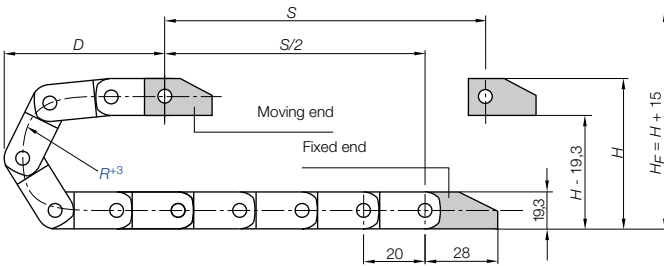

Short travels - unsupported

Unsupported E-Chains® feature positive camber over short travels. This must be accounted for when specifying the clearance height H_F . Please consult igus® if space is particularly restricted.

Pitch = 20 mm/link Links/m = 50 (1.000 mm) Chain length = $S/2 + K$

R	028	038	048
H	76	96	116
D	60	70	80
K	130	160	190

The required clearance height:
 $H_F = H + 15$ mm
 (with 0,3 kg/m fill weight)

Speed / acceleration FL_G	max. 20 [m/s] / max. 200 [m/s]
Speed / acceleration FL_B	max. 3 [m/s] / max. 6 [m/s]
Gliding speed / acceleration (maximum)	max. 10 [m/s] / max. 50 [m/s]
Material - permitted temperature °C	igumid G / -40° to +120° C
Flammability class, igumid G	VDE 0304 IIC UL94 HB

Technical Data



Details of material properties
 ► page 1.38



Zipper E-Chains®
 Inner height: 15 mm

Phone +49- (0) 22 03-96 49-800
 Fax +49- (0) 22 03-96 49-222



► page 4.5

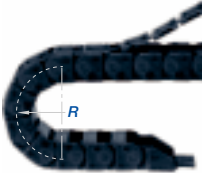
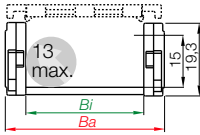

Part No. structure

09. 20. 038. 0

Color
black
Bending
radius
Width
Series

Series 09 E-Chain® - zip-open along outer radius

Part No.	Bi [mm]	Ba [mm]	R [mm]	Bending Radii			Weight [kg/m]
09.10.□.0	10	18,2	028	038	048	≈ 0,21	
09.16.□.0	16	24,2	028	038	048	≈ 0,24	
09.20.□.0	20	28,2	028	038	048	≈ 0,25	
09.30.□.0	30	38,2	028	038	048	≈ 0,28	
09.40.□.0	40	48,2	028	038	048	≈ 0,31	
09.50.□.0	50	58,2	028	038	048	≈ 0,34	

Supplement part no. with required radius (R) Example: 09.20.□038□.0

0 = standard color, other colors ► page 1.39 · Pitch = 20 mm/link - Links/m = 50





Polymer - pivoting

- One-piece mounting bracket
- Corrosion-resistant
- Available preassembled
- Inner and outer attachment possible
- Available with or without integrated strain relief tiwrap plates

Moving end with bore
(outer link) 080...1(PZ)

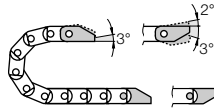

080...2(PZ) Fixed end
with pin (inner link)

Possible installation conditions for assembled mounting brackets ▶ Order example "preassembled" below

080...1(PZ)
Moving end

080...2(PZ)
Fixed end

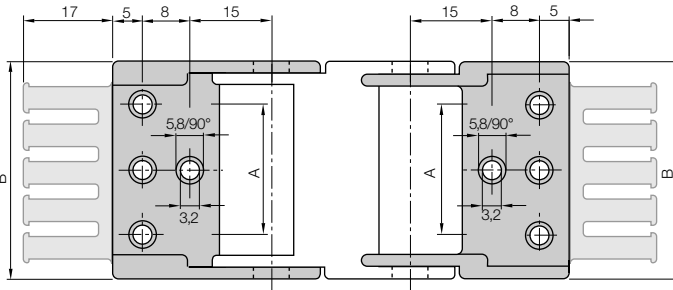

Dimensions and order configurations

Strain relief is possible on the moving end and/or the fixed end.

080.06.12 - 080.20.12: center bores only
080.30.12 - 080.50.12: bores (see figure above)

For E-chain®	Part No. full set with tiwrap plate	Part No. full set without tiwrap plate	Number of teeth	Dim. A [mm]	Dim. B [mm]
09.10. ▶	080.10. 12 PZ	080.10. 12	1	-	18,2
09.16. ▶	080.16. 12 PZ	080.16. 12	2	-	24,2
09.20. ▶	080.20. 12 PZ	080.20. 12	2	-	28,2
09.30. ▶	080.30. 12 PZ	080.30. 12	3	22	38,2
09.40. ▶	080.40. 12 PZ	080.40. 12	4	32	48,2
09.50. ▶	080.50. 12 PZ	080.50. 12	5	42	58,2

For the preassembled mode please add the index A1 ... A4 Example: 080.16. 12 PZ A1

Part No. structure

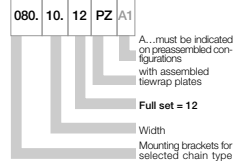

Full set, for both ends:
080. 10. 12 PZ +tiwrap plate

Single-part order:
080. 10. 1 PZ +tiwrap plate

Mounting bracket with bore
080. 10. 2 PZ +tiwrap plate

Mounting bracket with pin



Quicksnap - the complete, detachable mounting unit, available upon request



Quickfix - mounting bracket with dowel, available upon request

Additional Features

Phone +49- (0) 22 03-96 49-800
Fax +49- (0) 22 03-96 49-222





Price index



Cleanroom Class 1 (ISO class 3)
tested by the Dryden Engineering
Company, California



UL94-V2 classifications
upon request



Low-noise



"Zipper-fast" opening and closing

**When to use the Series 15:**

- If fast, zipper-like accessibility to cables is required
- If connection options are required (Quicksnap, Quickfix, ...)
- If interior separation is required
- If high stability and long service life are required

**When not to use it:**

- If opening of the link is not necessary
 - ▶ Series 10 E2 mini, page 5.48
- If torsion occurs
 - ▶ Series E14 Easy Chain®, page 3.32
- If the chain must snap-open along the inner radius
 - ▶ B15i E2 mini, page 5.70
- If a closed tube system is required
 - ▶ Series R15 Zipper, page 4.36

- ① "Zipper-fast" opening and closing
- ② For high acceleration
- ③ Large pins and double stop dog for superior life and long unsupported length
- ④ Zipper lids can be separated and joined at each chain link
- ⑤ Small pitch for low-noise, smooth operation
- ⑥ Mounting bracket with integrated strain relief
- ⑦ Interior separation with Vertical Separators and Full-Width Shelves possible
- ⑧ Also available as "Zipper" E-Tube Series R15 ▶ page 4.36

**Order example complete E-Chain®**Please indicate chain-lengths or number of links **Example: 1 m or 33 links**

1 m 15.025.038.0

E-Chain®

with 2 separators 154 assembled every 2nd link

Interior separation

1 set 1025.12PZ

Mounting bracket



Unsupported length

FL_G = with straight upper run

FL_B = with permitted sag

Further information ► Design, page 1.12

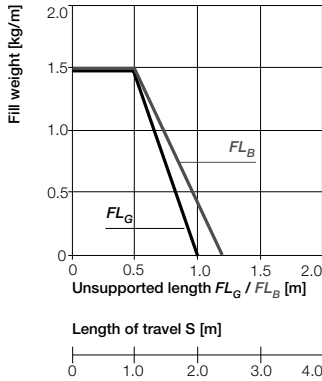
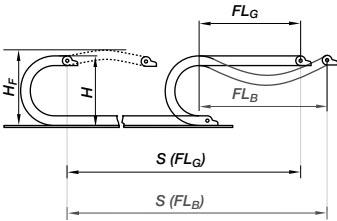

- S = Length of travel
- R = Bending radius
- H = Nominal clearance height
- H_F = Required clearance height
- D = Overlength E-Chain® radius in final position
- $K = \pi \cdot R + \text{"safety"}$

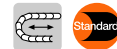
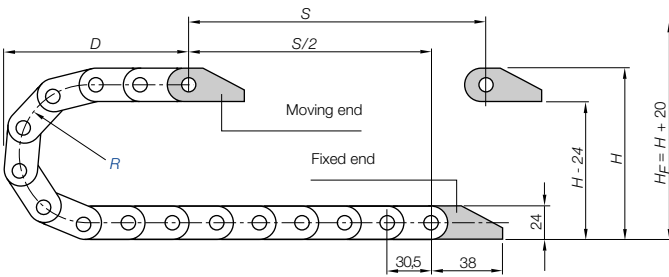

Short travels - unsupported

Unsupported E-Chains® feature positive camber over short travels. This must be accounted for when specifying the clearance height H_F . Please consult igus® if space is particularly restricted.

Pitch = 30,5 mm/link Links/m = 33 (1.006,5 mm) Chain length = $S/2 + K$

R	038	048	075	100	110	125	145	180
H	100	120	175	225	245	275	315	385
D	90	120	145	155	170	190	225	279
K	185	215	300	375	410	455	520	630

The required clearance height:
 $H_F = H + 20$ mm
 (with 1,0 kg/m fill weight)

Speed / acceleration FL_G	max. 20 [m/s] / max. 200 [m/s ²]
Speed / acceleration FL_B	max. 3 [m/s] / max. 6 [m/s ²]
Gliding speed / acceleration (maximum)	max. 10 [m/s] / max. 50 [m/s ²]
Material - permitted temperature °C	igumid G / -40° to +120° C
Flammability class, igumid G	VDE 0304 IIC UL94 HB

Technical Data



Details of material properties
 ► page 1.38



Zipper E-Chains®
 Inner height: 17 mm

Phone +49- (0) 22 03-96 49-800
 Fax +49- (0) 22 03-96 49-222



► page 4.5

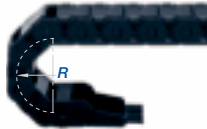
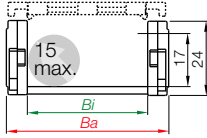

Part No. structure

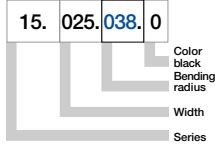

Series 15 E-Chain® - zip-open along outer radius

Part No.	Bi [mm]	Ba [mm]	R [mm]	Bending Radii								Weight [kg/m]
15.015.□.0	15	26	038	048	075	100	110	125	145	180	~ 0,35	
15.025.□.0	25	36	038	048	075	100	110	125	145	180	~ 0,40	
15.038.□.0	38	49	038	048	075	100	110	125	145	180	~ 0,46	
15.050.□.0	50	61	038	048	075	100	110	125	145	180	~ 0,52	
15.5.□.0	63	76	038	048	075	100	110	125	145	180	~ 0,63	
15.6.□.0	80	94	038	048	075	100	110	125	145	180	~ 0,70	
15.7.□.0	100	113	038	048	075	100	110	125	145	180	~ 0,76	

Supplement part no. with required radius (R) Example: 15.025.038.0

0 = standard color, other colors ► page 1.39 · Pitch = 30,5 mm/link - Links/m = 33



Zipper | Series 15 | Accessories | Interior Separation

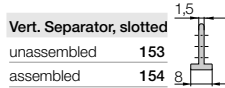

Option 1: Vertical Separators

- Vertical Separators are used if a vertical subdivision of the E-Chain® interior is required
- Standard subdivision with Vertical Separator, slotted 154, for combinations with Full-Width Shelf 111.X
- By standard Vertical Separators are assembled every other chain link.

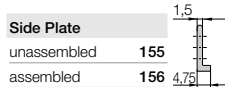
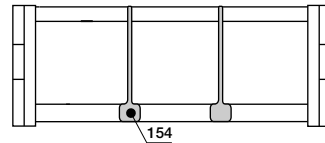

Option 2: Full-Width Shelves

- For applications involving many thin cables with similar or identical diameters.
- Side Plate 156 can be combined with Vertical Separator, slotted 154 and Full-Width Shelf 111.X

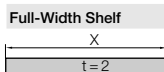
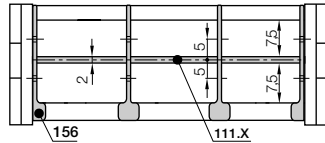

Width X [mm]	Part No. unassembled	Part No. assembled	Width X [mm]	Part No. unassembled	Part No. assembled
015	110.15	111.15	063	110.63	111.63
025	110.25	111.25	080	110.80	111.80
038	110.38	111.38	100	110.100	111.100
050	110.50	111.50			

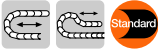

The Standard - option polymer - pivoting

- Recommended for unsupported and gliding applications
- Well suited for tight installation conditions
- Strain relief with detachable tiewrap plates
- Variable traverse angle for flexible assembly
- The twistability of the E-Chain® and the option to assemble the mounting brackets on the fixed end and/or the moving end, enable various installation options

Moving end with bore
(outer link) 10...3P(Z)

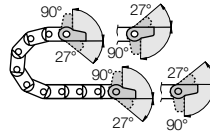

10...4P(Z) Fixed end
with pin (inner link)

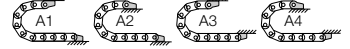

Possible installation conditions for assembled mounting brackets ▶ Order example "preassembled" below

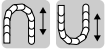

Option polymer - locking

- Recommended for unsupported and gliding applications
- Furthermore:
- At very high speed and/or acceleration
 - If space is limited for height (the H_F measurement)
 - The twistability of the E-Chain® and the option to assemble the mounting brackets on the fixed end and/or the moving end, enable various installation options

Moving end with bore
(outer link) 10...1P(Z)

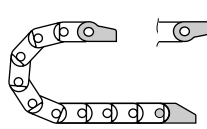

10...2P(Z) Fixed end
with pin (inner link)

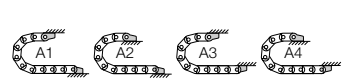

Possible installation conditions for assembled mounting brackets ▶ Order example "preassembled" below

10...3P(Z) Standard! (pivoting)
10...1P(Z) (locking)

Moving end

For E-chain®:
15.015. to 15.050.

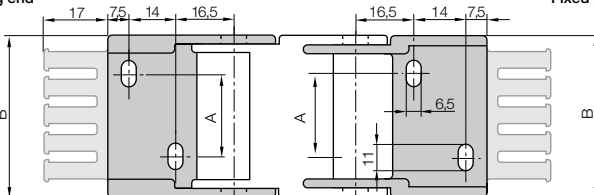

For E-chain®:
15.5 to 15.7.

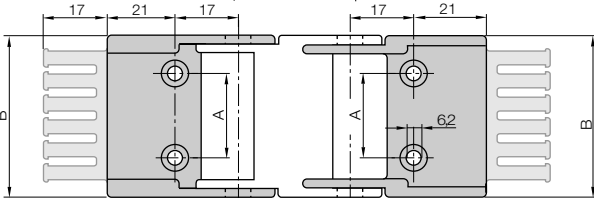

For E-chain®	Part No. full set with tiewrap plate	Part No. full set without tiewrap plate	Number of teeth	Dim. A [mm]	Dim. B [mm]
15.015. ▶	1015. [] PZ	1015. [] P	2	-	25,5
15.025. ▶	1025. [] PZ	1025. [] P	3	10	35,5
15.038. ▶	1038. [] PZ	1038. [] P	4	23	48,5
15.050. ▶	1050. [] PZ	1050. [] P	5	35	60,5
15.5. ▶	105. [] PZ	105. [] P	6	48	75,0
15.6. ▶	106. [] PZ	106. [] P	8	65	92,0
15.7. ▶	107. [] PZ	107. [] P	10	85	112,0

Please add the Part No. with the requested index - 34 for the pivoting configuration

e.g. 1015. [34] PZ or 12 for the locking configuration e.g. 1015. [12] PZ

For the preassembled mode please add the index [A1]...[A4] e.g. 1015. [34] PZ [A1]

Standard! (pivoting) 10...4P(Z)
(locking) 10...2P(Z)

Fixed end

Dimensions and order configurations

Strain relief is possible on the moving end and/or the fixed end.

Part No. structure (pivoting)

1015. 34 PZ A1



A... must be indicated on preassembled configurations with assembled tiewrap plates
Full set pivoting = 34
Mounting brackets for selected chain type

Full set, for both ends:

[1015. [34] PZ] +tiewrap plate

Single-part order:

[1015. [3] PZ] +tiewrap plate

Mounting bracket with bore

[1015. [4] PZ] +tiewrap plate

Mounting bracket with pin

Part No. structure (locking)

1015. 12 PZ A1

A... must be indicated on preassembled configurations with assembled tiewrap plates
Full set star = 12
Mounting brackets for selected chain type

Full set, for both ends:

[1015. [12] PZ] +tiewrap plate

Single-part order:

[1015. [1] PZ] +tiewrap plate

Mounting bracket with bore

[1015. [2] PZ] +tiewrap plate

Mounting bracket with pin

Quicksnap + Quickfix upon request

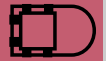

▶ page 4.5

B_a = Outer width E-Chains® / E-Tube

B_i = Inner width E-Chains® / E-Tube

h_a = Outer height E-Chains® / E-Tube

H_{Ri} = Inner trough height

H_{Ra} = Outer trough height

B_{Ri} = Inner trough width ► depends on dim. B_a

B_{Ra} = Outer trough width

n_{Mon} = Number of installation sets (left/right)

n_{Ri} = Number of troughs sets (left/right)

$$H_{Ri} \geq 2 \cdot h_a$$

$$B_{Ri} \geq B_a + 4$$

● = Guide trough set ● = Glide bar

● = Installation set "Basic" ● = C-profile

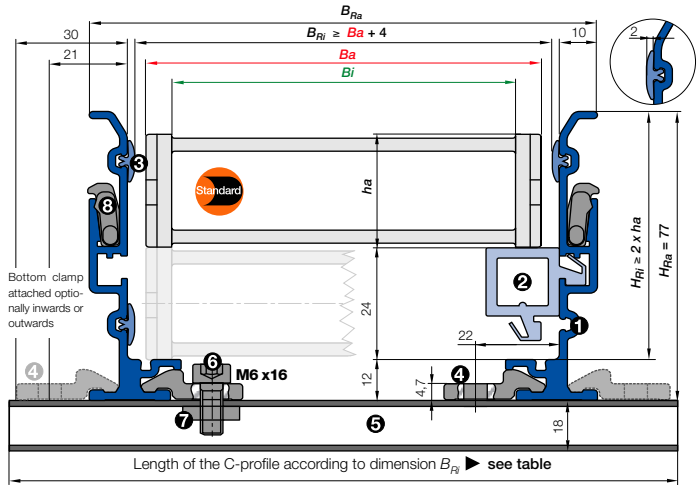

Phone +49- (0) 22 03-96 49-800
 Fax +49- (0) 22 03-96 49-222

Installation set "Basic" with C-profile

Bottom Clamp attached optionally inwards or outwards

15.050.038.0 ► Order example

B_{Ri} [mm]	Part No. attached inwards	Part No. attached outwards	Order example	
			Part No.	Part No.
.015 30	-	960.30.125		
.025 40	-	960.30.150		
.038 53	-	960.30.150		
.050 65	960.30.125	960.30.175		
.5 80	960.30.125	960.30.175		
.6 98	960.30.150	960.30.200		
.7 117	960.30.175	960.30.225		



● Components, trough "Basic": ① Trough side parts, aluminum, 2 m ② Glide bar, plastic, 2 m ③ Glide strips, plastic, 2 m (without glide strips on request) ● Components, installation set "Basic": ④ Bottom clamp, aluminum ⑤ C-profile, steel galvanized ⑥ Screw M6 x 16 ⑦ Sliding nut M6 ⑧ Interface connector, plastic

igus® GmbH
 51147 Cologne



Order example: Length of travel 30 m -
 Center mounted for Series 15.050.038.0 with $B_{Ri} = 65$

Guide trough set (set of 2 trough side parts, incl. glide strips) **without** glide bar

Order text: 16 m guide trough without glide bar (8 x 2 m sections) **Part No. 970.30.SL**

Guide trough set (set of 2 trough side parts, incl. glide strips) **with** glide bar

Order text: 16 m guide trough with glide bar (8 x 2 m sections) **Part No. 970.31.SL**

Installation set "Basic" complete (guide trough-sets + 1)

Order text: 17 installation sets "Basic" **Part No. 960.30.125**

Module for the fixed end

Order text: 1 set **Part No. 970.80**

Option: For an additional noise dampening with

silencer profile, please add Index A - Example: **Part No. 970.30.SLA**

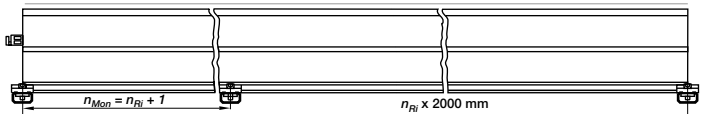

Principle sketch: Number of installation sets to be installed = Number of trough sections + 1



A quick fix for mounting the stationary end of an E-Chain®

With this module for the fixed end, fast and easy mounting onto the Aluminum "SuperTrough" is now possible without any drilling. Fast mounting of the E-Chain® by clamping onto the aluminum trough

● Quick relocation of the stationary end ● No drilling necessary

Internet: www.igus.eu
 E-mail: info@igus.de

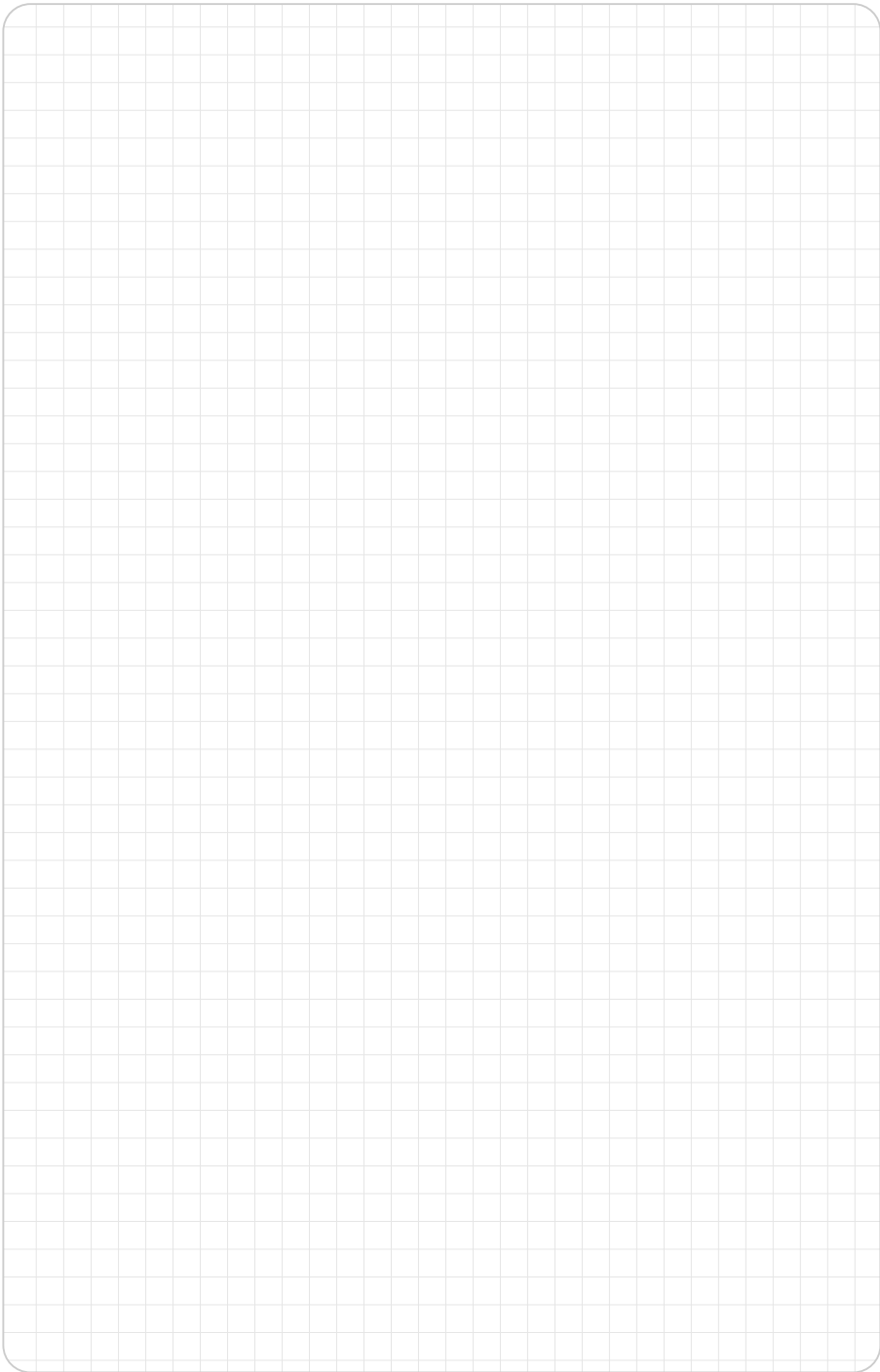

Zipper E-Chains®
Inner height: 17 mm

Phone +49- (0) 22 03-96 49-800
Fax +49- (0) 22 03-96 49-222



▶ chapter 9



▶ page 4.5

Zipper | E-Chains® | Series 17



Price index



Upon request: Cleanroom Class 1
(ISO class 3) tested by the Dryden
Engineering Company, California



UL94-V2 classifications
upon request



Low-noise



"Zipper-fast" opening and closing



When to use the Series 17:

- If fast, zipper-like accessibility to cables is required
- If connection options are required (Quicksnap, Quickfix, ...)
- If quiet operation is required
- If aesthetic design is required



When not to use it:

- If individual links must snap-open, as opposed to "unzip"
▶ Series B17 E2 mini, page 5.76
- If torsion occurs
▶ Series E16 Easy Chain®, page 3.42
- If a closed tube system is required
▶ Series R17 Zipper, page 4.42

- 1 "Zipper-fast" opening and closing
- 2 Small pitch for low-noise, smooth operation
- 3 For high acceleration
- 4 Zipper lids can be separated and joined at each chain link
- 5 Interior separation with Vertical Separators and Full-Width Shelves possible
- 6 Mounting bracket with integrated strain relief
- 7 Also available as "Zipper" E-Tube Series R17 ▶ page 4.42

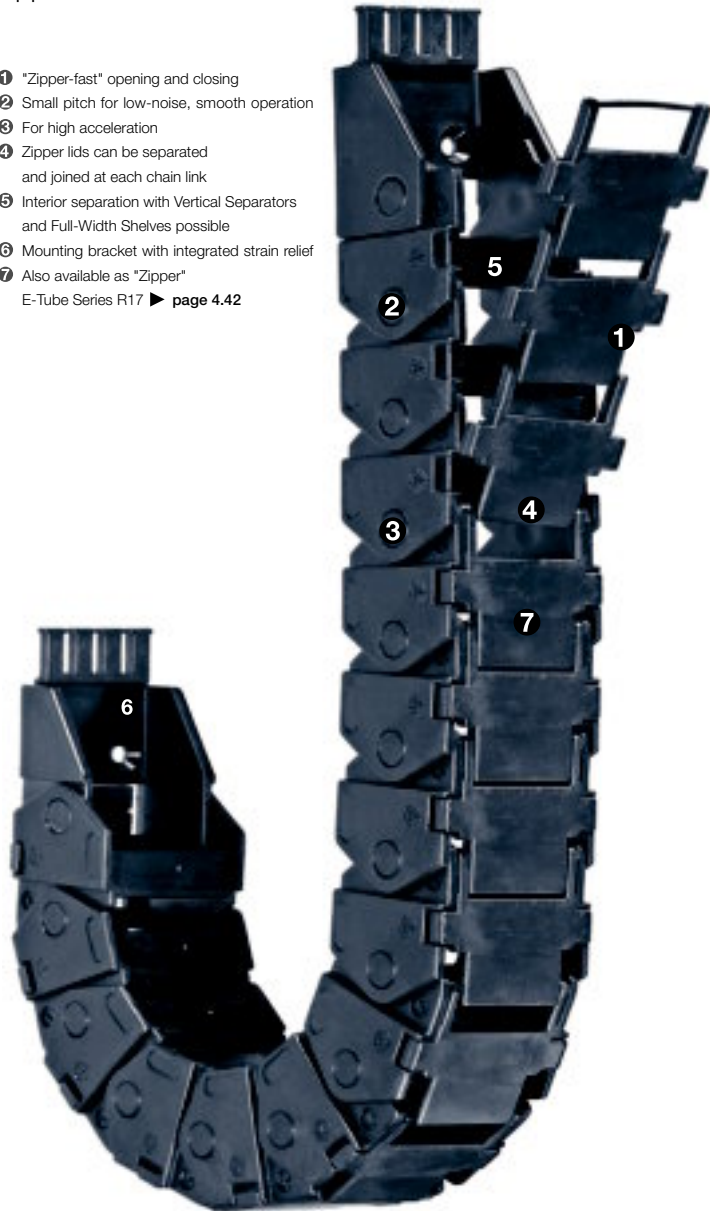

Order example complete E-Chain®

Please indicate chain-lengths or number of links Example: 1 m or 33 links

1 m 17.2.063.0

E-Chain®

with 2 separators 172 assembled every 2nd link  Interior separation

1 set 117.2.12PZ



Mounting bracket



Unsupported length

FL_G = with straight upper run

FL_B = with permitted sag

Further information ► Design, page 1.12

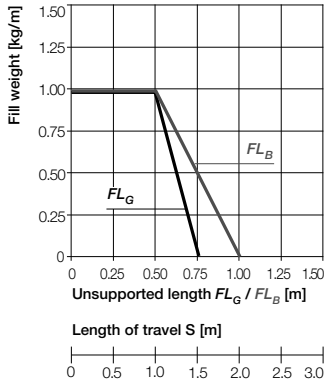
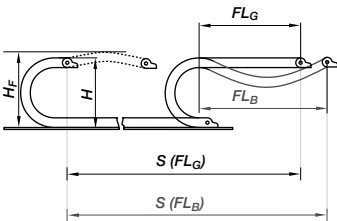

- S = Length of travel
- R = Bending radius
- H = Nominal clearance height
- H_f = Required clearance height
- D = Overlength E-Chain® radius in final position
- $K = \pi \cdot R + \text{"safety"}$

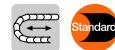
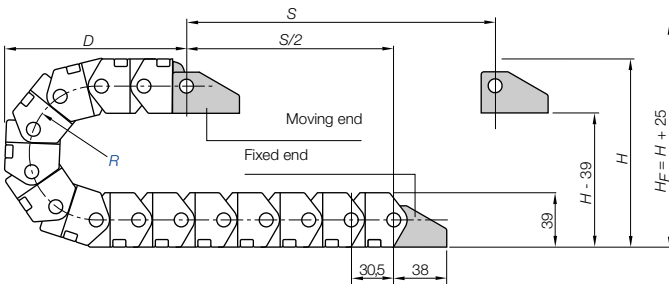

Short travels - unsupported

Unsupported E-Chains® feature positive camber over short travels. This must be accounted for when specifying the clearance height H_f . Please consult igus® if space is particularly restricted.

Pitch = 30,5 mm/link Links/m = 33 (1.006,5 mm) Chain length = $\frac{S}{2} + K$

R	063	075	100	125
H	165	189	239	289
D	115	130	155	180
K	275	305	395	475

The required clearance height:
 $H_f = H + 25$ mm
 (with 1,5 kg/m fill weight)

Speed / acceleration FL_G	max. 20 [m/s] / max. 200 [m/s ²]
Speed / acceleration FL_B	max. 3 [m/s] / max. 6 [m/s ²]
Gliding speed / acceleration (maximum)	max. 10 [m/s] / max. 50 [m/s ²]
Material - permitted temperature °C	igumid G / -40° to +120° C
Flammability class, igumid G	VDE 0304 IIC UL94 HB

Technical Data



Details of material properties
 ► page 1.38



Zipper E-Chains®
 Inner height: 32 mm

Phone +49- (0) 22 03-96 49-800
 Fax +49- (0) 22 03-96 49-222



► page 4.5

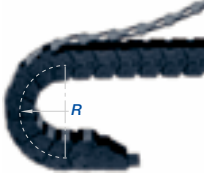
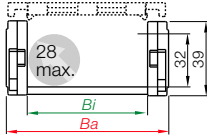

Part No. structure

17. 2. 063. 0



Series 17 E-Chain® - zip-open along outer radius

Part No.	Bi [mm]		Ba [mm]		R [mm]			Bending Radii	Weight [kg/m]
	0	1	0	1	063	075	100		
17.1.	15	26	063	075	100	125		~ 0,52	
17.2.	25	36	063	075	100	125		~ 0,59	
17.3.	38	49	063	075	100	125		~ 0,65	
17.4.	50	61	063	075	100	125		~ 0,70	
17.5.	63	76	063	075	100	125		~ 0,83	
17.6.	80	94	063	075	100	125		~ 0,92	
17.7.	100	113	063	075	100	125		~ 1,06	

Supplement part no. with required radius (R) Example: 17.2.063.0

0 = standard color, other colors ► page 1.39 · Pitch = 30,5 mm/link - Links/m = 33



Zipper | Series 17 | Accessories | Interior Separation

Vert. Separator, slotted for 17.1 to 17.4

unassembled	171
assembled	172



Vert. Separator, slotted for 17.5 to 17.7

unassembled	173
assembled	174



Option 1: Vertical Separators

- Vertical Separators are used if a vertical subdivision of the E-Chain® interior is required
- Standard horizontal subdivision on Series 17.1 to 17.4: with Vertical Separator, slotted 172, for Series 17.5 to 17.7: Vertical Separator, slotted 174, both for combinations with Full-Width Shelf 111.X
- By standard Vertical Separators are assembled every other chain link.

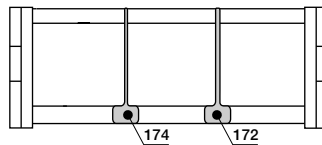

Side Plate for 17.1 to 17.4

unassembled	175
assembled	176



Side Plate for 17.5 to 17.7

unassembled	177
assembled	178



Option 2: Full-Width Shelves

- For applications involving many thin cables with similar or identical diameters
- Side Plate 176 (Series 17.1 to 17.4) and 178 (Series 17.5 to 17.8) can be combined with Vertical Separator, slotted 172 or 174 and Full-Width Shelf 111.X

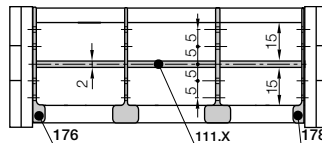

Full-Width Shelf

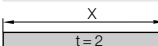

Width X [mm]	Part No. unassembled	Part No. assembled
015	110.15	111.15
025	110.25	111.25
038	110.38	111.38
050	110.50	111.50

Width X [mm]	Part No. unassembled	Part No. assembled
063	110.63	111.63
080	110.80	111.80
100	110.100	111.100



Polymer, one-piece

- One-piece mounting bracket
- Corrosion-resistant
- Available preassembled
- Inner and outer attachment possible
- Available with or without integrated strain relief tiwrap plates

Moving end with bore (outer link) 117...1P(Z)

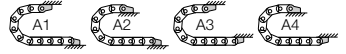
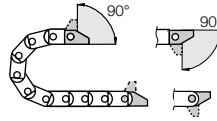

117...2P(Z) Fixed end with pin (inner link)

Possible installation conditions for assembled mounting brackets ▶ Order example "preassembled" below

117...1P(Z)
Moving end

117...2P(Z)
Fixed end

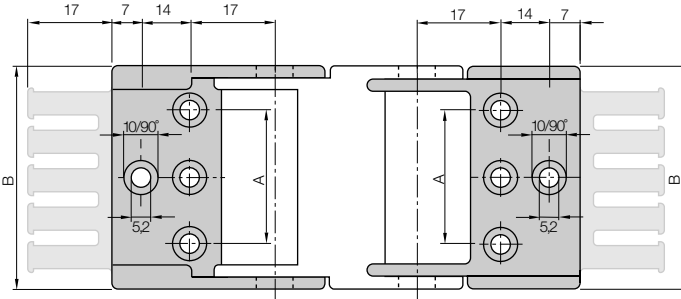

117.1.12P(Z): center bores only

117.2.12P(Z) - 117.7.12P(Z): outer bores only

For E-chain®	Part No. full set with tiwrap plate	Part No. full set without tiwrap plate	Number of teeth	Dim. A [mm]	Dim. B [mm]
17.1. ▶	117.1. 12 PZ	117.1. 12 P	2	-	25,5
17.2. ▶	117.2. 12 PZ	117.2. 12 P	3	12	35,5
17.3. ▶	117.3. 12 PZ	117.3. 12 P	4	25	48,5
17.4. ▶	117.4. 12 PZ	117.4. 12 P	5	37	60,5
17.5. ▶	117.5. 12 PZ	117.5. 12 P	6	48	76,0
17.6. ▶	117.6. 12 PZ	117.6. 12 P	8	65	93,0
17.7. ▶	117.7. 12 PZ	117.7. 12 P	10	85	113,0

For the preassembled mode please add the index A1 ... A4. Example: 117.1. 12 PZ A1

Dimensions and order configurations

Strain relief is possible on the moving end and/or the fixed end.

Part No. structure

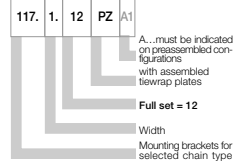

Full set, for both ends:

117.1. 12 PZ +tiwrap plate

Single-part order:

117.1. 1 PZ +tiwrap plate

Mounting bracket with bore

117.1. 2 PZ +tiwrap plate

Mounting bracket with pin



Quicksnap - the complete, detachable mounting unit, available upon request



Quickfix - mounting bracket with dowel, available upon request

Additional Features

Phone +49- (0) 22 03-96 49-800
Fax +49- (0) 22 03-96 49-222



Zipper | E-Tubes | Series R07



Price index



Upon request: Cleanroom Class 1
(ISO class 3) tested by the Dryden
Engineering Company, California



UL94-V2 classifications
upon request



Low-noise



"Zipper-fast" opening and closing



When to use the Series R07:

- If extremely quick, zipper-like access to cables is required
- If chip protection is required
- If quick, easy insertion of cables with preassembled connectors is required
- If aesthetic design is required



When not to use it:

- If opening of the link is not necessary
 - ▶ Series 06 E2 micro, page 5.26
- If cable installation without opening lids is possible
 - ▶ Series E06 Easy Chain®, page 3.20

- ① "Zipper-fast" opening and closing
- ② Small pitch for low-noise, smooth operation
- ③ For high acceleration
- ④ Light weight
- ⑤ Zipper lids can be separated and joined at each chain link
- ⑥ Protection against dirt and chips
- ⑦ Mounting bracket with integrated strain relief
- ⑧ Smallest zip-open E-Tube
- ⑨ Also available as "Zipper" E-Chain® Series 07 ▶ page 4.10



Order example complete E-Tube

Please indicate tube-lengths or number of links Example: 1 m or 50 links

1 m R07.20.038.0



E-Tube

1 set 060.20.12PZ



Mounting bracket



Unsupported length

FL_G = with straight upper run

FL_B = with permitted sag

Further information ► **Design, page 1.12**

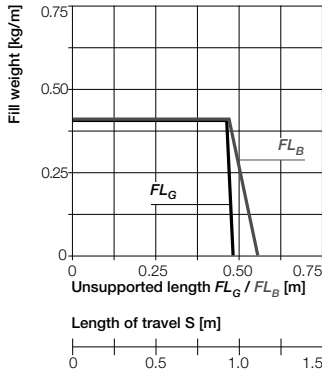
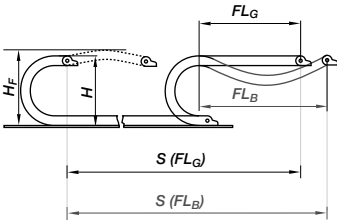

- S = Length of travel
- R = Bending radius
- H = Nominal clearance height
- H_F = Required clearance height
- D = Overlength E-Chain® radius in final position
- $K = \pi \cdot R + \text{"safety"}$

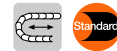
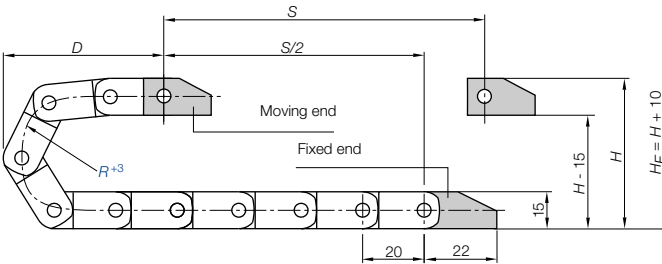

Short travels - unsupported

Unsupported E-Chains® feature positive camber over short travels. This must be accounted for when specifying the clearance height H_F . Please consult igus® if space is particularly restricted.

Pitch = 20 mm/link Links/m = 50 (1.000 mm) Chain length = $S/2 + K$

R	038	048
H	92	112
D	65	75
K	160	190

The required clearance height:
 $H_F = H + 10$ mm
 (with 0.2 kg/m fill weight)



Zipper EE- Tubes
 Inner height: 10,3 mm

Phone +49- (0) 22 03-96 49-800
 Fax +49- (0) 22 03-96 49-222



Speed / acceleration FL_G	max. 20 [m/s] / max. 200 [m/s]
Speed / acceleration FL_B	max. 3 [m/s] / max. 6 [m/s]
Gliding speed / acceleration (maximum)	max. 10 [m/s] / max. 50 [m/s]
Material - permitted temperature °C	igumid G / -40° to +120° C
Flammability class, igumid G	VDE 0304 IIC UL94 HB

Technical Data



Details of material properties
 ► page 1.38



► page 4.5

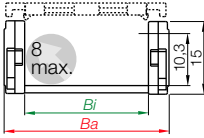

Part No. structure

R07.	20.	038.	0
------	-----	------	---



Series R07 E-Tube - zip-open along the outer radius

Part No.	<i>Bi</i> [mm]	<i>Ba</i> [mm]	<i>R</i> [mm]	Bending Radii	Weight [kg/m]
R07.10.□.0	10	16,5	038	048	≈ 0,14
R07.16.□.0	16	22,5	038	048	≈ 0,16
R07.20.□.0	20	27,0	038	048	≈ 0,17
R07.30.□.0	30	37,0	038	048	≈ 0,20
R07.40.□.0	40	47,0	038	048	≈ 0,23
R07.50.□.0	50	57,0	038	048	≈ 0,26

Supplement part no. with required radius (*R*) Example: R07.20.038.0

0 = standard color, other colors ► page 1.39 · Pitch = 20 mm/link - Links/m = 50





Polymer, one-piece

- One-piece mounting bracket
- Corrosion-resistant
- Available preassembled
- Inner and outer attachment possible
- Available with or without integrated strain relief tiwrap plates

Moving end with bore
(outer link) 060...1(PZ)

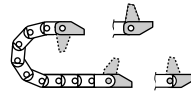

060...2(PZ) Fixed end
with pin (inner link)

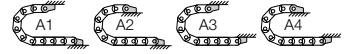

Possible installation conditions for assembled mounting brackets ▶ Order example "preassembled" below

060...1(PZ)

Moving end

060...2(PZ)

Fixed end

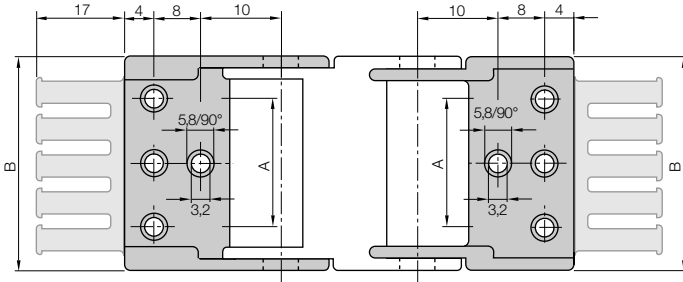

060.10.12 - 060.20.12: center bores only

060.30.12 - 060.50.12: outer bores only

For E-chain*	Part No. full set with tiwrap plate	Part No. full set without tiwrap plate	Number of teeth	Dim. A [mm]	Dim. B [mm]
R07.10. ▶	060.10. 12 PZ	060.10. 12	1	-	16,5
R07.16. ▶	060.16. 12 PZ	060.16. 12	2	-	22,5
R07.20. ▶	060.20. 12 PZ	060.20. 12	2	-	27,0
R07.30. ▶	060.30. 12 PZ	060.30. 12	3	22	37,0
R07.40. ▶	060.40. 12 PZ	060.40. 12	4	32	47,0
R07.50. ▶	060.50. 12 PZ	060.50. 12	5	42	57,0

For the preassembled mode please add the index **A1**...**A4** Example: 060.10. 12 **A1**

Dimensions and order configurations

Strain relief is possible on the moving end and/or the fixed end.

Part No. structure

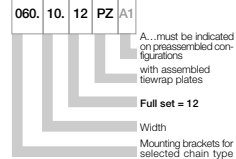

Full set, for both ends:

060. 10. 12 PZ +tiwrap plate

Single-part order:

060. 10. 1 PZ +tiwrap plate

Mounting bracket with bore

060. 10. 2 PZ +tiwrap plate

Mounting bracket with pin



Quicksnap - the complete, detachable mounting unit, available upon request



Quickfix - mounting bracket with dowel, available upon request

Additional Features

Phone +49- (0) 22 03-96 49-800
Fax +49- (0) 22 03-96 49-222





Price index



Upon request: Cleanroom Class 1
(ISO class 3) tested by the Dryden
Engineering Company, California



UL94-V2 classifications
upon request



iF-Design
Award Winner



Low-noise



"Zipper-fast" opening and closing

**When to use the Series R09:**

- If extremely quick, zipper-like access to cables is required
- If chip protection is required
- If quick, easy insertion of cables with preassembled connectors is required
- If aesthetic design is required

**When not to use it:**

- If opening of the link is not necessary
 - ▶ Series 08 E2 micro, page 5.34
- If cable installation without opening lids is possible
 - ▶ Series E08 Easy Chain®, page 3.28

- 1 "Zipper-fast" opening and closing
- 2 Small pitch for low-noise, smooth operation
- 3 Protection against dirt and chips
- 4 iF-Design Award Winner
- 5 Light weight
- 6 Zipper lids can be separated and joined at each chain link
- 7 For high acceleration
- 8 Mounting bracket with integrated strain relief
- 9 Small zip-open E-Tube
- 10 Also available as "Zipper" E-Chain® Series 09 ▶ page 4.14

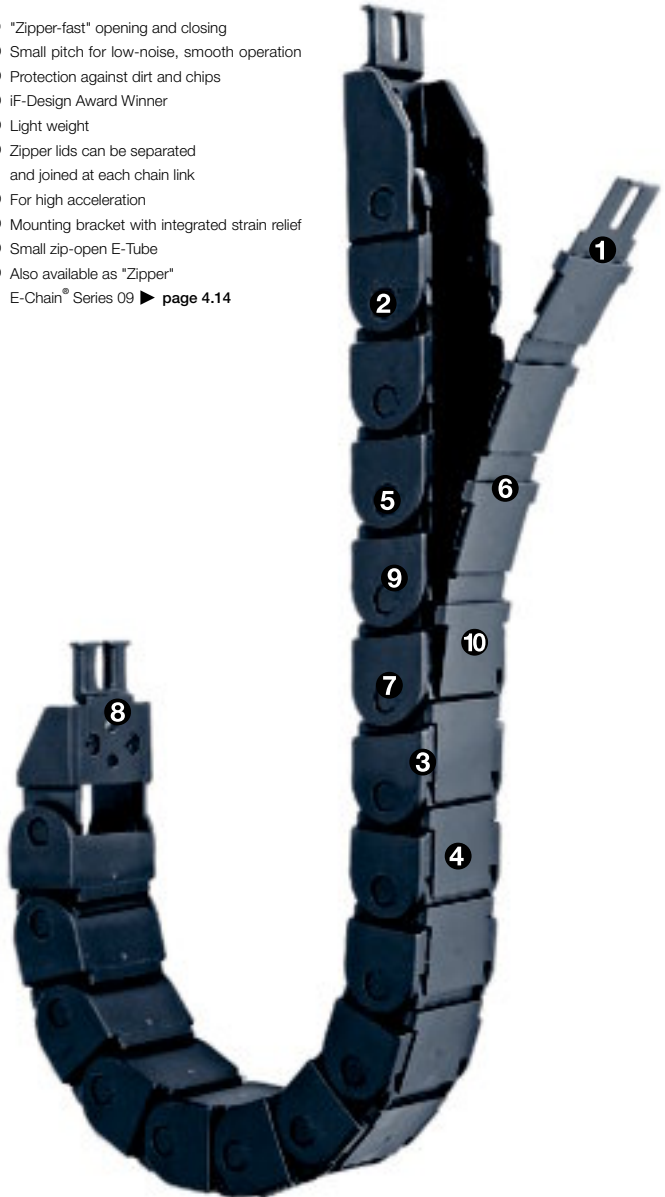
**Order example complete E-Tube**

Please indicate tube-lengths or number of links Example: 1 m or 50 links

1 m R09.20.048.0



E-Tube

1 set 080.20.12PZ



Mounting bracket



Unsupported length

FL_G = with straight upper run

FL_B = with permitted sag

Further information ► **Design, page 1.12**

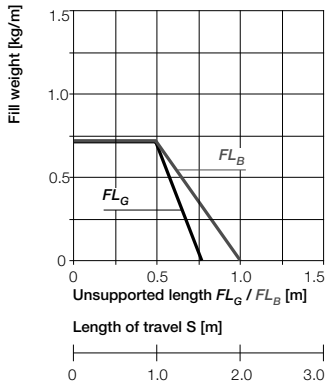
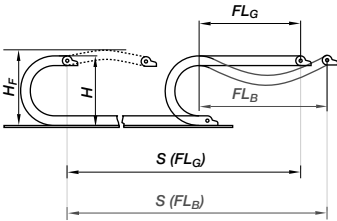

- S = Length of travel
- R = Bending radius
- H = Nominal clearance height
- H_F = Required clearance height
- D = Overlength E-Chain® radius in final position
- $K = \pi \cdot R + \text{"safety"}$

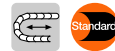
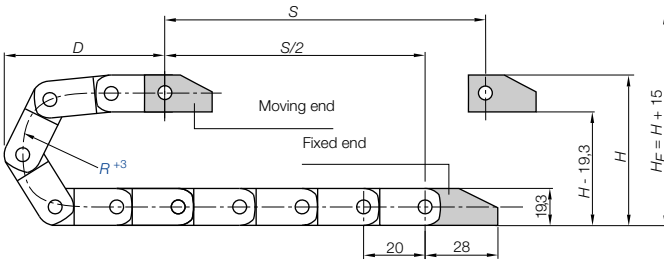

Short travels - unsupported

Unsupported E-Chains® feature positive camber over short travels. This must be accounted for when specifying the clearance height H_F . Please consult igus® if space is particularly restricted.

Pitch = 20 mm/link Links/m = 50 (1.000 mm) Chain length = $S/2 + K$

R	048	075	100
H	116	170	220
D	80	107	132
K	190	280	360

The required clearance height:
 $H_F = H + 15$ mm
 (with 0,3 kg/m fill weight)



Zipper E-Tubes
 Inner height: 15 mm

Phone +49- (0) 22 03-96 49-800
 Fax +49- (0) 22 03-96 49-222



► page 4.5

Speed / acceleration FL_G	max. 20 [m/s] / max. 200 [m/s ²]
Speed / acceleration FL_B	max. 3 [m/s] / max. 6 [m/s ²]
Gliding speed / acceleration (maximum)	max. 10 [m/s] / max. 50 [m/s ²]
Material - permitted temperature °C	igumid G / -40° to +120° C
Flammability class, igumid G	VDE 0304 IIC UL94 HB

Technical Data



Details of material properties
 ► page 1.38

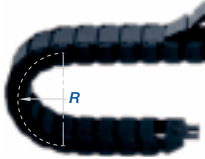
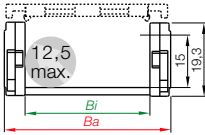

Part No. structure

R09. 20. 048. 0



Series R09 E-Tube - zip-open along the outer radius

Part No.	Bi [mm]	Ba [mm]	R [mm]	Bending Radii			Weight [kg/m]
R09.10. .0	10	18,2	048	075	100	≈ 0,21	
R09.16. .0	16	24,2	048	075	100	≈ 0,24	
R09.20. .0	20	28,2	048	075	100	≈ 0,25	
R09.30. .0	30	38,2	048	075	100	≈ 0,28	
R09.40. .0	40	48,2	048	075	100	≈ 0,31	
R09.50. .0	50	58,2	048	075	100	≈ 0,34	

Supplement part no. with required radius (R) Example: R09.20. 048. 0

0 = standard color, other colors ► page 1.39 · Pitch = 20 mm/link - Links/m = 50





Polymer, one-piece

- One-piece mounting bracket
- Corrosion-resistant
- Available preassembled
- Inner and outer attachment possible
- Available with or without integrated strain relief tiwrap plates

Moving end with bore (outer link) 080...1(PZ)

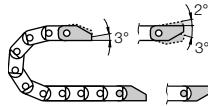

080...2(PZ) Fixed end with pin (inner link)

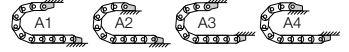

Possible installation conditions for assembled mounting brackets ▶ Order example "preassembled" below

080...1(PZ)

Moving end

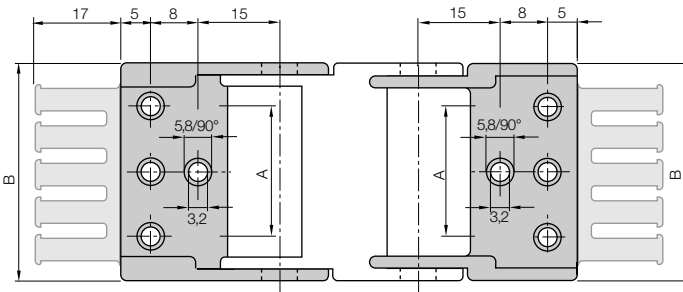

080...2(PZ)

Fixed end

Dimensions and order configurations

Strain relief is possible on the moving end and/or the fixed end.

080.10.12 - 080.20.12: center bores only

080.30.12 - 080.50.12: bores (see figure above)

For E-chain*	Part No. full set with tiwrap plate	Part No. full set without tiwrap plate	Number of teeth	Dim. A [mm]	Dim. B [mm]
R09.10. ▶	080.10. 12 PZ	080.10. 12	1	-	18,2
R09.16. ▶	080.16. 12 PZ	080.16. 12	2	-	24,2
R09.20. ▶	080.20. 12 PZ	080.20. 12	2	-	28,2
R09.30. ▶	080.30. 12 PZ	080.30. 12	3	22	38,2
R09.40. ▶	080.40. 12 PZ	080.40. 12	4	32	48,2
R09.50. ▶	080.50. 12 PZ	080.50. 12	5	42	58,2

For the preassembled mode please add the index **A1** ... **A4** Example: 080.16. 12 **A1**

Part No. structure

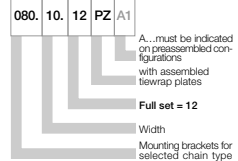

Full set, for both ends:

080. | 10. | 12 | PZ |+tiwrap plate

Single-part order:

080. | 10. | 1 | PZ |+tiwrap plate

Mounting bracket with bore

080. | 10. | 2 | PZ |+tiwrap plate

Mounting bracket with pin



Quicksnap - the complete, detachable mounting unit, available upon request



Quickfix - mounting bracket with dowel, available upon request

Additional Features





Price index



Upon request: Cleanroom Class 1
(ISO class 3) tested by the Dryden
Engineering Company, California



UL94-V2 classifications
upon request



Low-noise



"Zipper-fast" opening and closing

**When to use the Series R15:**

- If extremely quick, zipper-like access to cables is required
- If chip protection is required
- If quick, easy insertion of cables with preassembled connectors is required
- If aesthetic design is required

**When not to use it:**

- If opening of the link is not necessary
 - ▶ Series 10 E2 mini, page 5.48
- If torsion occurs
 - ▶ Series E14 Easy Chain®, page 3.32
- If the chain must snap-open along the inner radius
 - ▶ B15i E2 mini, page 5.70

- ① "Zipper-fast" opening and closing
- ② Small pitch for low-noise, smooth operation
- ③ Protection against dirt and chips
- ④ Large pins and double stop dog for superior life and long unsupported length
- ⑤ Zipper lids can be separated and joined at each chain link
- ⑥ Mounting bracket with integrated strain relief
- ⑦ For high acceleration
- ⑧ Also available as "Zipper" E-Chain® Series 15 ▶ page 4.18

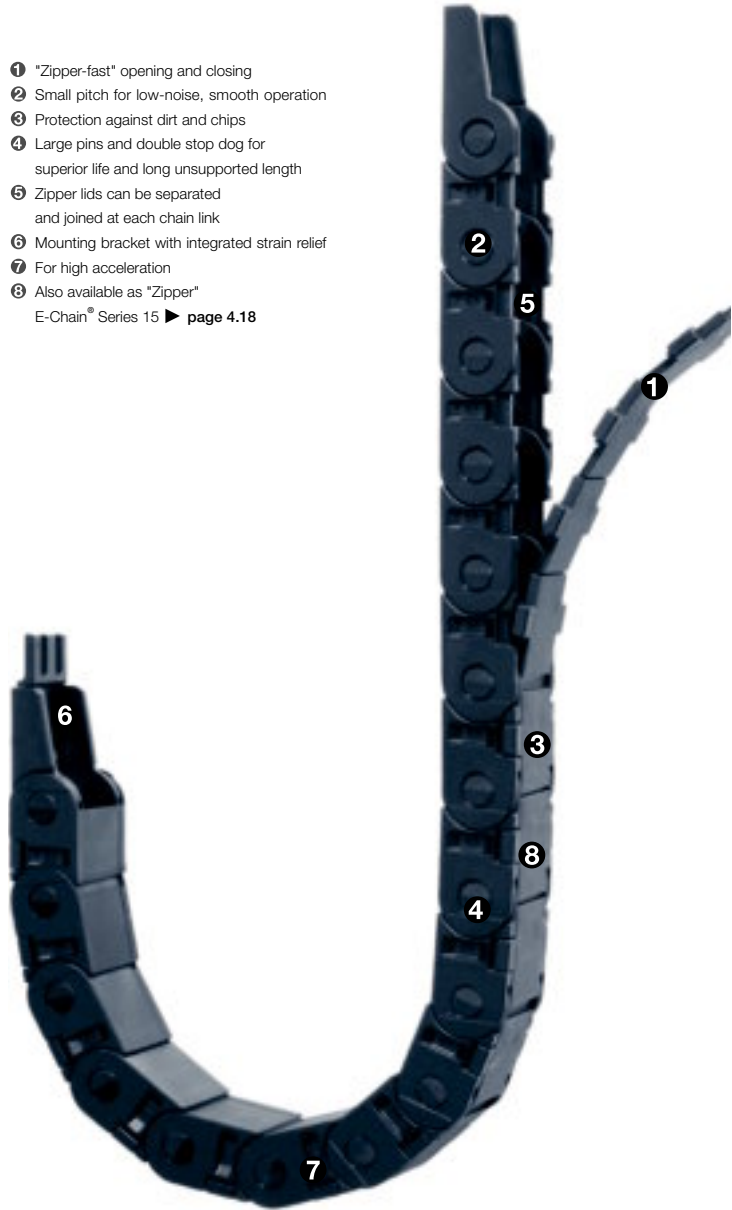
**Order example complete E-Tube**

Please indicate tube-lengths or number of links Example: 1 m or 33 links

1 m R15.025.063.0

 E-Tube
with 2 separators R154 assembled every 2nd link
 Interior separation

1 set 1025.12PZ

 Mounting bracket

Unsupported length

FL_G = with straight upper run

FL_B = with permitted sag

Further information ► **Design, page 1.12**

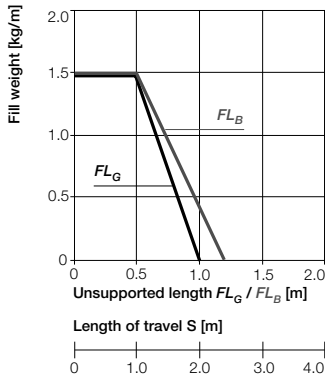
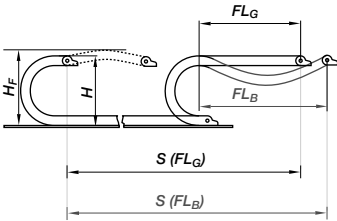

- S = Length of travel
- R = Bending radius
- H = Nominal clearance height
- H_F = Required clearance height
- D = Overlength E-Chain® radius in final position
- $K = \pi \cdot R + \text{"safety"}$

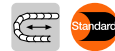
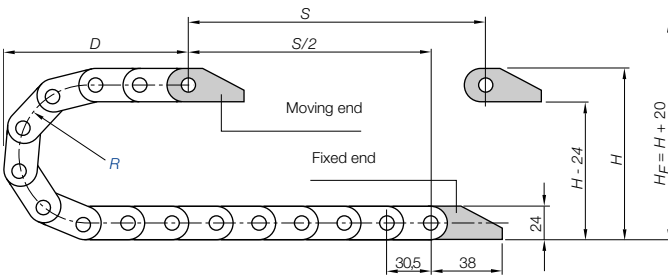

Short travels - unsupported

Unsupported E-Chains® feature positive camber over short travels. This must be accounted for when specifying the clearance height H_F . Please consult igus® if space is particularly restricted.

Pitch = 30,5 mm/link Links/m = 33 (1.000 mm) Chain length = $\frac{S}{2} + K$

R	063	075	100	110	125	145	180
H	150	175	225	245	275	315	385
D	120	145	155	170	190	225	279
K	260	300	375	410	455	520	630

The required clearance height:
 $H_F = H + 20$ mm
 (with 1,0 kg/m fill weight)

Speed / acceleration FL_G	max. 20 [m/s] / max. 200 [m/s ²]
Speed / acceleration FL_B	max. 3 [m/s] / max. 6 [m/s ²]
Gliding speed / acceleration (maximum)	max. 10 [m/s] / max. 50 [m/s ²]
Material - permitted temperature °C	igumid G / -40° to +120° C
Flammability class, igumid G	VDE 0304 IIC UL94 HB

Technical Data



Details of material properties
 ► page 1.38



Zipper E-Tubes
 Inner height: 17 mm

Phone +49- (0) 22 03-96 49-800
 Fax +49- (0) 22 03-96 49-222



► page 4.5

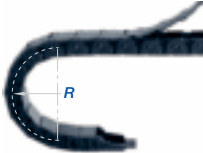
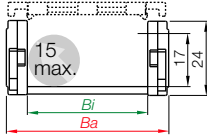

Part No. structure

R15. 025. 063. 0



Series R15 E-Tube - zip-open along the outer radius

Part No.	Bi [mm]	Ba [mm]	R [mm]	Bending Radii	Weight [kg/m]
R15.025. .0	25	36	063	075 100 110 125 145 180	~ 0,40
R15.038. .0	38	49	063	075 100 110 125 145 180	~ 0,46
R15.063. .0	63	76	063	075 100 110 125 145 180	~ 0,63
R15.080. .0	80	94	063	075 100 110 125 145 180	~ 0,70

More E-Tube widths are available upon request.

Supplement part no. with required radius (R) Example: R15.025.063.0

0 = standard color, other colors ▶ page 1.39 · Pitch = 30,5 mm/link - Links/m = 33



Zipper | **Series R15** | Accessories | Interior Separation

Vert. Separator, slotted	
unassembled	R153
assembled	R154



Option 1: Vertical Separators

- **Vertical Separators** are used if a vertical subdivision of the E-Chain® interior is required
- **Standard** subdivision with **Vertical Separator, slotted 154**, for combinations with **Full-Width Shelf 111.X**
- **By standard Vertical Separators** are assembled every other chain link

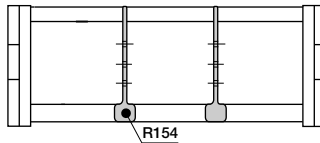

Option 2: Full-Width Shelves

- For applications involving many thin cables with similar or identical diameters

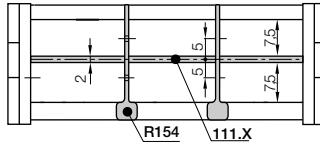

Full-Width Shelf
X
t=2

Width X [mm]	Part No. unassembled	Part No. assembled
025	110.25	111.25
038	110.38	111.38

Width X [mm]	Part No. unassembled	Part No. assembled
063	110.63	111.63
080	110.80	111.80

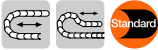

The Standard - option polymer - pivoting

- Recommended for unsupported and gliding applications
- Well suited for tight installation conditions
- Available with or without strain relief tiwrap plates
- Variable traverse angle for flexible assembly

Moving end with bore
(outer link) 10...3P(Z)

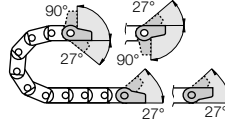

10...4P(Z) Fixed end
with pin (inner link)

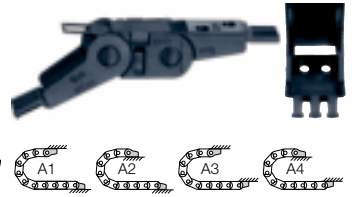

Possible installation conditions for assembled mounting brackets ▶ Order example "preassembled" below

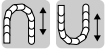

Option polymer - locking

- Recommended for unsupported and gliding applications
- At very high speed and/or acceleration
- If space is limited for height (the H_F measurement)

Moving end with bore
(outer link) 10...1P(Z)

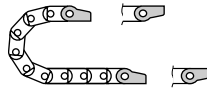

10...2P(Z) Fixed end
with pin (inner link)

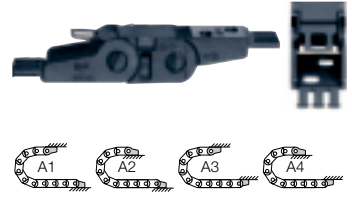

Possible installation conditions for assembled mounting brackets ▶ Order example "preassembled" below

10...3P(Z) Standard! (pivoting)
10...1P(Z) (locking)

Moving end

R15.025

R15.063 - R15.080

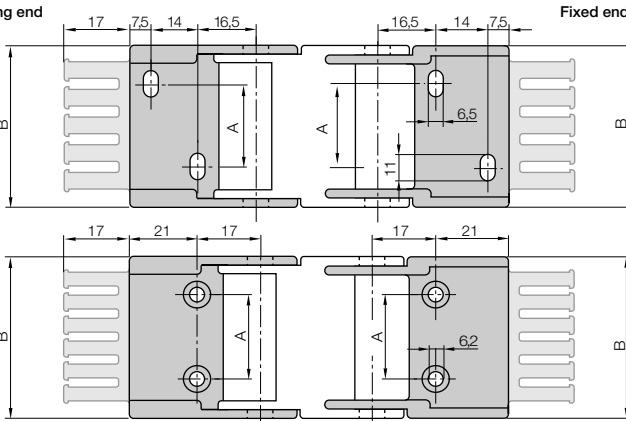

Für E-chain®	Part No. full set with tiwrap plate	Part No. full set without tiwrap plate	Number of teeth	Dim. A [mm]	Dim. B [mm]
R15.025	▶ 1025. [] PZ	1025. [] P	3	10	35,5
R15.038	▶ 1038. [] PZ	1038. [] P	4	23	48,5
R15.063	▶ 105. [] PZ	105. [] P	6	48	75,0
R15.080	▶ 106. [] PZ	106. [] P	8	65	92,0

Please add the Part No. with the requested index - 34 for the pivoting configuration e.g. 1025. [34] PZ or 12 for the locking configuration e.g. 1025. [12] PZ. For the preassembled mode please add the index [A1]...[A4] e.g. 1025. [34] PZ [A1]

Dimensions and order configurations

Strain relief is possible on the moving end and/or the fixed end.

Part No. structure (pivoting)

1025. 34 PZ A1



A... must be indicated on preassembled configurations with assembled tiwrap plates
Full set pivoting = 34
Mounting brackets for selected chain type

Full set, for both ends:

1025. 34 PZ +tiwrap plate

Single-part order:

1025. 3 PZ +tiwrap plate

Mounting bracket with bore

1025. 4 PZ +tiwrap plate

Mounting bracket with pin

Part No. structure (locking)

1025. 12 PZ A1

A... must be indicated on preassembled configurations with assembled tiwrap plates
Full set star = 12
Mounting brackets for selected chain type

Full set, for both ends:

1025. 12 PZ +tiwrap plate

Single-part order:

1025. 1 PZ +tiwrap plate

Mounting bracket with bore

1025. 2 PZ +tiwrap plate

Mounting bracket with pin

Quicksnap + Quickfix upon request



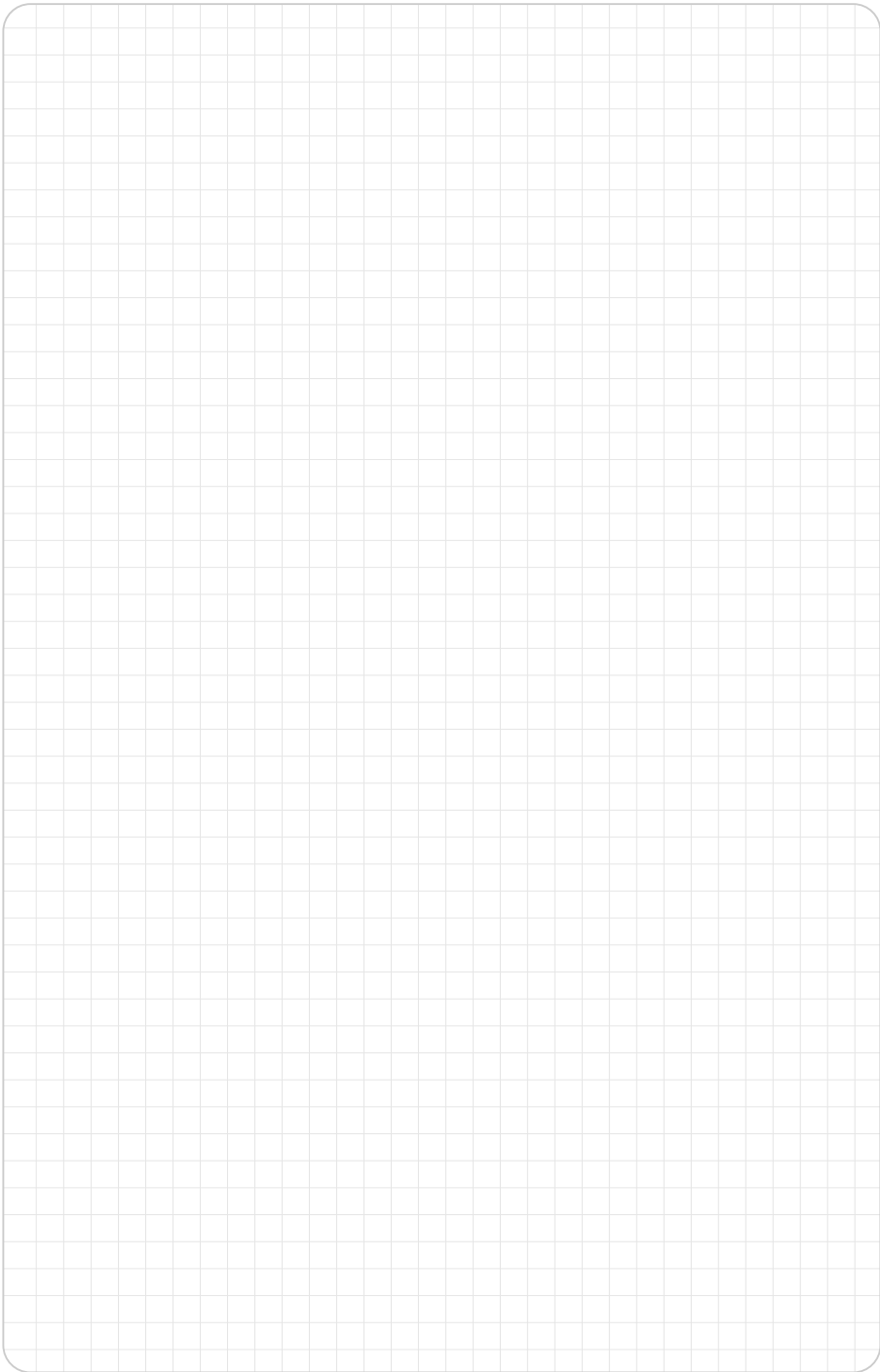

Zipper E-Chains®
Inner height: 17 mm

Tel. +49- (0) 22 03-96 49-800
Fax +49- (0) 22 03-96 49-222



► Kapitel 9



► Seite 4.5



Price index



Upon request: Cleanroom Class 1 (ISO class 3) tested by the Dryden Engineering Company, California



UL94-V2 classifications upon request



Low-noise



"Zipper-fast" opening and closing

**When to use the Series R17:**

- If extremely quick, zipper-like access to cables is required
- If chip protection is required
- If quick, easy insertion of cables with preassembled connectors is required
- If aesthetic design is required

**When not to use it:**

- If cable installation without opening lids is possible
- **Series E16 Easy Chain**, page 3.42

Zipper | E-Tubes | **Series R17**

- 1 "Zipper-fast" opening and closing
- 2 Small pitch for low-noise, smooth operation
- 3 For high acceleration
- 4 Zipper lids can be separated and joined at each chain link
- 5 Mounting bracket with integrated strain relief
- 6 Smooth exterior and interior
- 7 Large pivot pins for long service life
- 8 Also available as "Zipper" E-Chain® Series 17 ► **page 4.24**

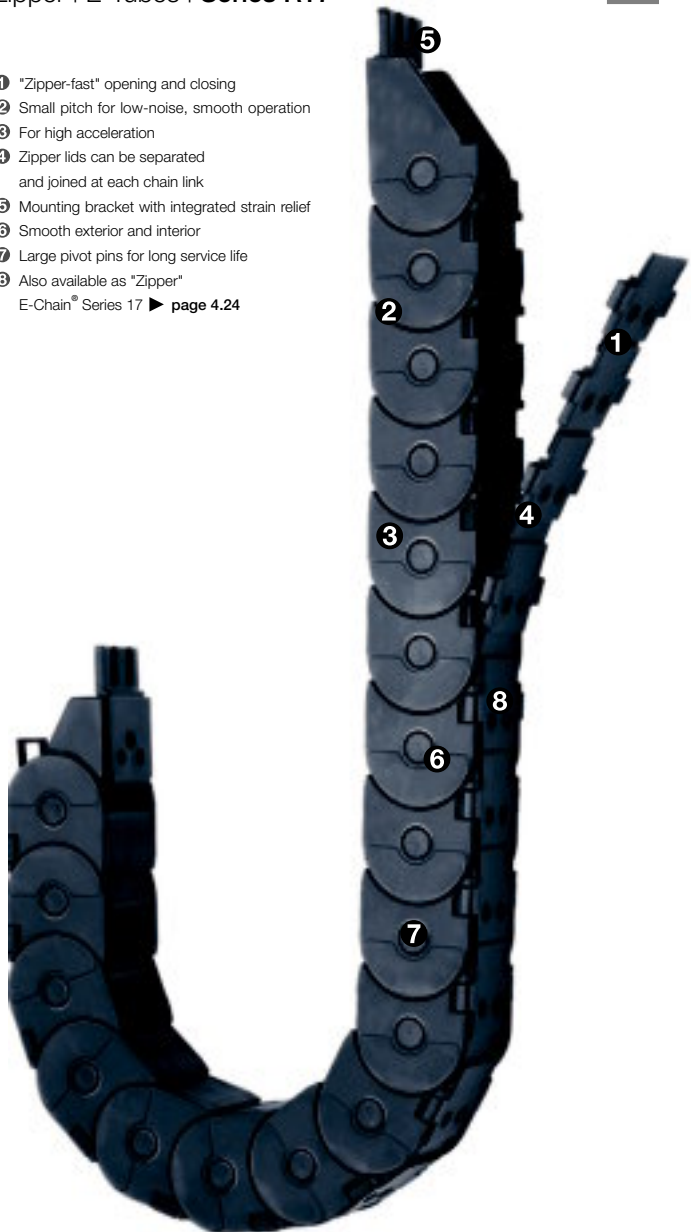
**Order example complete E-Tube**Please indicate chain-lengths or number of links **Example: 1 m or 33 links**1 m **R17.025.063.0** **E-Chain®**with 2 separators **R172** assembled every 2nd link **Interior separation**1 set **117.025.12PZ** **Mounting bracket**

Unsupported length

FL_G = with straight upper run

FL_B = with permitted sag

Further information ► **Design, page 1.12**

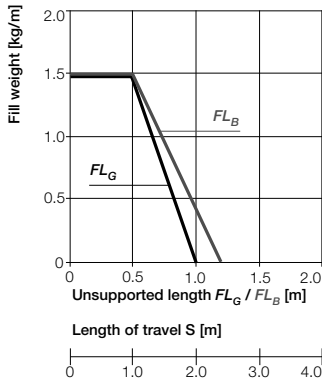
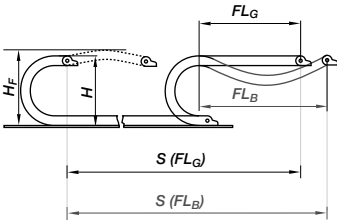

- S = Length of travel
- R = Bending radius
- H = Nominal clearance height
- H_F = Required clearance height
- D = Overlength E-Chain® radius in final position
- $K = \pi \cdot R + \text{"safety"}$

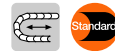
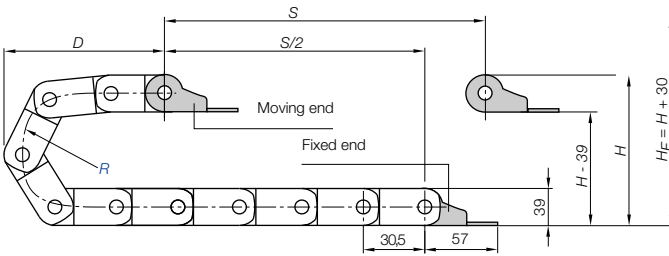

Short travels - unsupported

Unsupported E-Chains® feature positive camber over short travels. This must be accounted for when specifying the clearance height H_F . Please consult igus® if space is particularly restricted.

Pitch = 30,5 mm/link Links/m = 33 (1.006,5 mm) Chain length = $S/2 + K$

R	063	075	100	125
H	165	189	239	289
D	115	130	155	180
K	275	305	395	475

The required clearance height:
 $H_F = H + 30$ mm
 (with 1,0 kg/m fill weight)

Speed / acceleration FL_G	max. 20 [m/s] / max. 200 [m/s ²]
Speed / acceleration FL_B	max. 3 [m/s] / max. 6 [m/s ²]
Gliding speed / acceleration (maximum)	max. 10 [m/s] / max. 50 [m/s ²]
Material - permitted temperature °C	igumid G / -40° to +120° C
Flammability class, igumid G	VDE 0304 IIC UL94 HB

Technical Data



Details of material properties
 ► page 1.38



Zipper E-Tubes
 Inner height: 32 mm

Phone +49- (0) 22 03-96 49-800
Fax +49- (0) 22 03-96 49-222



► page 4.5

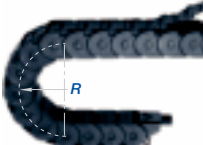
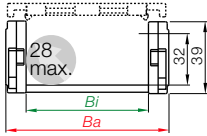

Part No. structure

R17. 025. 063. 0



Series R17 E-Chain® - zip-open along outer radius

Part No.	Bending Radii				Weight [kg/m]		
	B_i [mm]	B_a [mm]	R [mm]				
R17.015.□.0	15	26	063	075	100	125	~ 0,52
R17.025.□.0	25	36	063	075	100	125	~ 0,59
R17.063.□.0	63	76	063	075	100	125	~ 0,83

Supplement part no. with required radius (R) Example: R17.025.063.0

0 = standard color, other colors ▶ page 1.39 - Pitch = 30,5 mm/link - Links/m = 33



Zipper | **Series R17 | Accessories** | Interior Separation

Vert. Separator, slotted	
unassembled	R171
assembled	R172



Option 1: Vertical Separators

- **Vertical Separators** are used if a vertical subdivision of the E-Chain® interior is required
- **Standard** subdivision with **Vertical Separator, slotted 172**, for combinations with **Full-Width Shelf 111.X**
- **By standard Vertical Separators** are assembled every other chain link

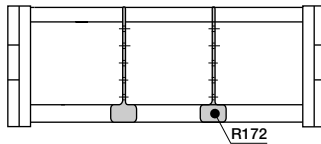

Option 2: Full-Width Shelves

- For applications involving many thin cables with similar or identical diameters.

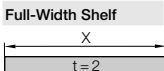
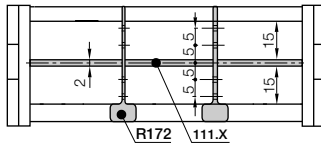

Width X [mm]	Part No. unassembled	Part No. assembled
015	110.15	111.15
025	110.25	111.25

Width X [mm]	Part No. unassembled	Part No. assembled
063	110.63	111.63



Polymer - locking

- One-piece mounting bracket
- Corrosion-resistant
- Available preassembled
- Inner and outer attachment possible
- Available with or without integrated strain relief tiewrap plates

Moving end with bore (outer link) 117...1P(Z)

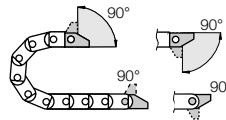

117...2P(Z) Fixed end with pin (inner link)



Possible installation conditions for assembled mounting brackets ▶ Order example "preassembled" below

117...1P(Z)
Moving end

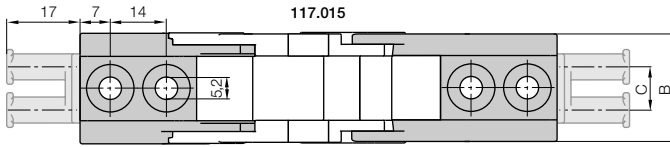

117...2P(Z)
Fixed end

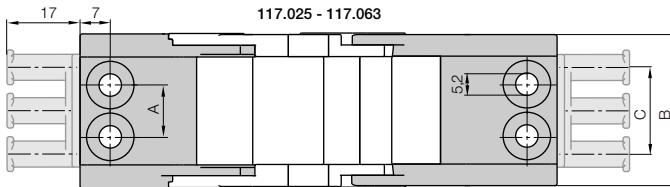

Dimensions and order configurations

Strain relief is possible on the moving end and/or the fixed end.

Part No. structure

117. 015. 12 PZ A1

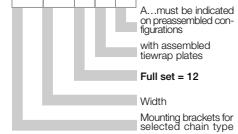

Full set, for both ends:

[117.]015.[12] PZ +tiewrap plate

Single-part order:

[117.]015.[1] PZ +tiewrap plate

Mounting bracket **with bore**

[117.]015.[2] PZ +tiewrap plate

Mounting bracket **with pin**

For E-chain*	Part No. full set with tiewrap plate	Part No. full set without tiewrap plate	Number of teeth	Dim. A [mm]	Dim. B [mm]	Dim. C [mm]
R17.015.	▶ 117.015. [12] PZ	117.015. [12] P	2	–	25,7	10
R17.025.	▶ 117.025. [12] PZ	117.025. [12] P	3	12	35,7	20
R17.063.	▶ 117.063. [12] PZ	117.063. [12] P	6	48	73,7	50

For the **preassembled** mode please add the index [A1]...[A4] **Example:** 117.015. [12] PZ[A1]



Quicksnap - the complete, detachable mounting unit, available upon request



Quickfix - mounting bracket with dowel, available upon request

Additional Features

Phone +49- (0) 22 03-96 49-800
Fax +49- (0) 22 03-96 49-222







System

E2

micro | mini | E2/000



E2 micro ▶ from page 5.4

- E-Chains® for smallest inner heights
- One-piece E-Chains®
- Space-saving ratio of inner-to-outer dimensions
- Inner heights 5 - 15 mm



E2 mini ▶ from page 5.42

- Small and medium sizes
- Small pitch for smooth running
- One and two-piece E-Chains®
- Inner heights 17 - 41 mm



System E2/000 ▶ from page 5.86

- E2 Standard - as E-Chain®, half E-Tube and fully enclosed E-Tube available
- Snap-open mechanism, snap-open on left or right
- Lightning fast with thumb catch - secure fit without additional locking devices
- Excellent mechanical stability, long life due to design and material
- Inner heights 21 - 45 mm

E2 micro and mini - Smallest and small E-Chains® for tight spaces with interior heights from 5 to 41 mm. The 2-piece E2 micro and mini E-Chains® are very lightweight, easy to assemble and cost-efficient. Many accessories are available. Perfect to use for short travels and unsupported applications ► **E2 micro page 5.4 and E2 mini page 5.42.**

System E2/000 - Standard medium sized E-Chains® and E-Tubes with interior heights from 21 to 45 mm. To open from left or right side, as E-Chain®, half and fully closed E-Tube available. Very easy to assemble and cost-efficient due to the 2-piece design. E-Chains® and E-Tubes with excellent mechanical stability and lifetime. Wide range of separator- and strain relief program. Suitably for long (gliding) travels and unsupported applications. Many accessories are available ► **page 5.86**

Comparison of the main characteristics

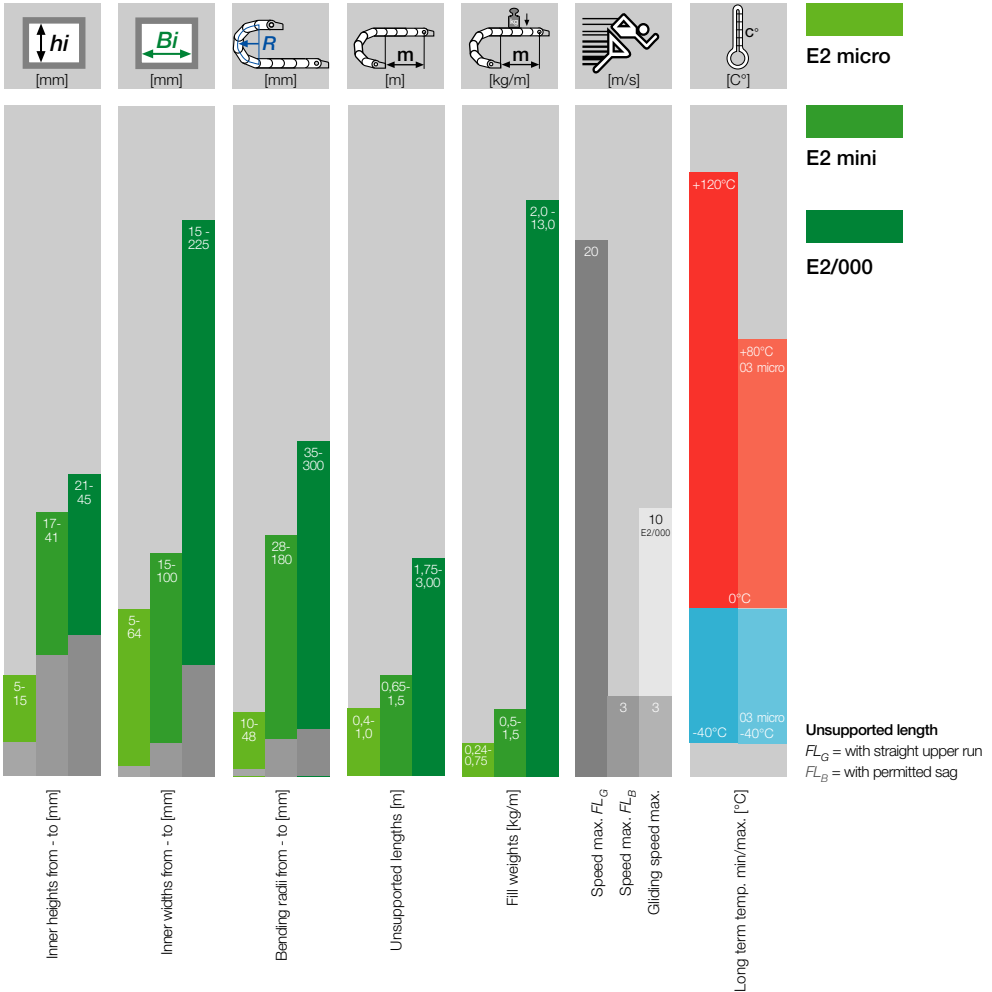

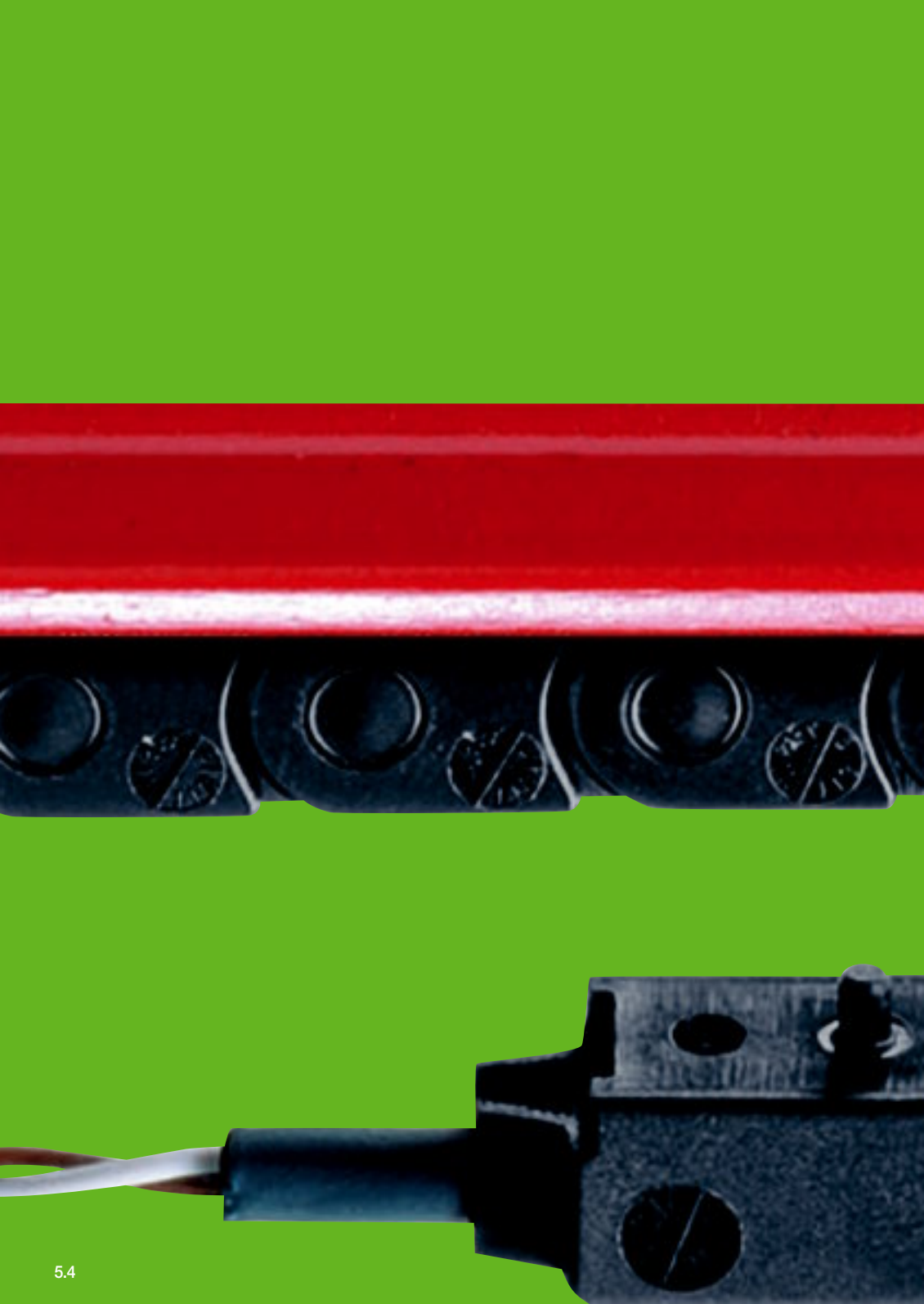

E2 micro



E2 micro E-Chains® - Smallest inner heights and bending radii

E2 micro are very small, one-piece or two-piece (B07/B09), light-weight E-Chains® ideal for high dynamic applications. E2 micro E-Chains® are very cost effective and available in thousands of variations. igus® also offers a host of accessories and fixation options. "Upgrades" to openable versions are available for many types. In these cases they are interchangeable and offer by this more service as repair kits or new installations.

Typical industries and applications

- Models (micro E-Chains®)
- Automatic doors
- Vehicles
- Measuring machines
- Electric equipment
- Handlings
- Pick and place robots
- General machinery



iF-Design Award -
for E2 micro - Series 05



Special equipment: Electrically conductive
ESD/ATEX version upon request



IPA Qualification Certificate:
Cleanroom test upon request



UL94 - V2 classifications for Series 03
and Series 04 (others upon request)



Smallest inner heights 5 mm:
Series 03 E2 micro

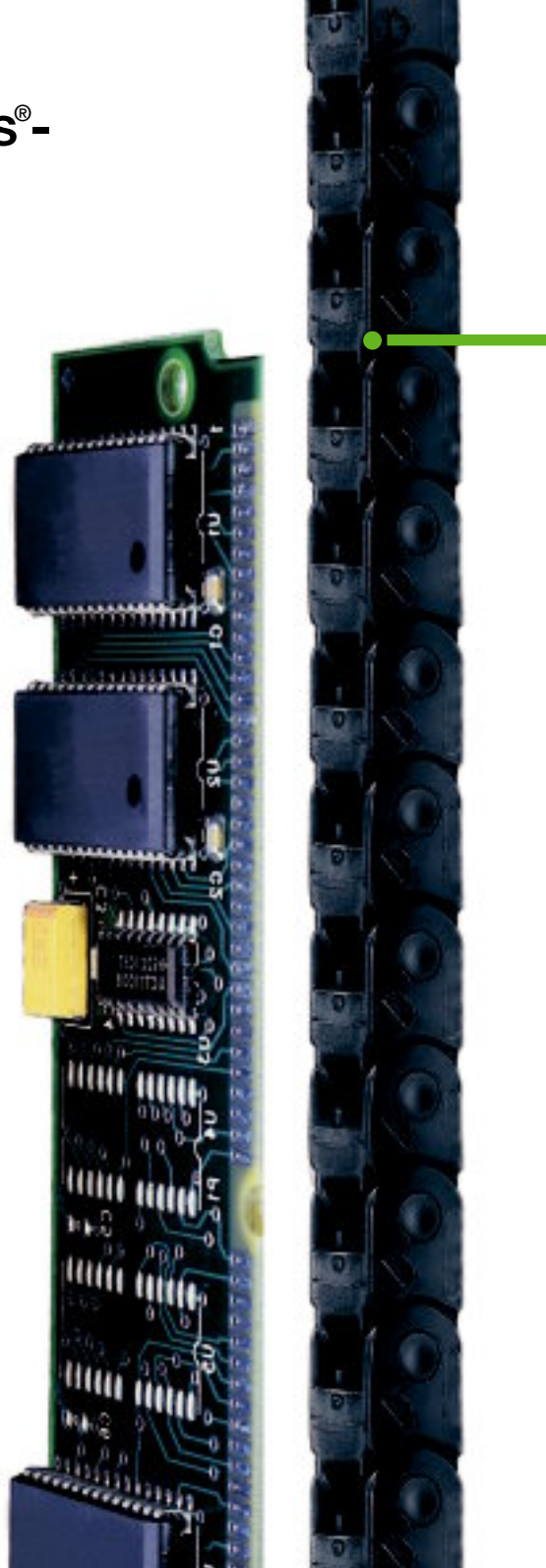



igus® E2 micro E-Chains® are robust for standing applications



Sliding door in train - UL 94-V2 version



Sliding door in subway with igus® Chainflex® CF9 cable for smallest spaces

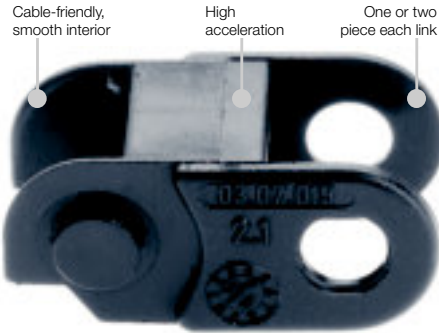

- One- and two-piece E-Chains®, from inner height of 5 mm
- High torsional rigity
- Smallest inner heights and bending radii
- Mounting brackets optional with strain relief
- Small pitch for smooth running
- Cable-friendly, smooth interior
- Low weight
- Large pins for longer life
- Space-saving ratio of inner-to-outer dimensions
- B07/B09 two-piece - Snap-open along outer radius with film-hinge
- You can find more technical data about the material, chemical resistance, temperatures ► [chapter design, from page 1.38](#)

Selection table

Series	Inner height <i>hi</i> [mm]	Inner width <i>Bi</i> [mm]	Outer width <i>Ba</i> [mm]	Outer height <i>ha</i> [mm]	Bending radius <i>R</i> [mm]	Unsupported length max. [m]	Page
03	5,0	5 - 10	8,7 - 13,7	8,0	10 - 28	0,40	5.10
04	7,0	7 - 30	12,0 - 35,0	10,0	15 - 48	0,50	5.14
045	10,3	6 - 64	12,0 - 70,0	12,5	18 - 38	0,50	5.18
05	10,0	6 - 64	10,0 - 68,0	12,0	18 - 38	0,55	5.22
06	10,5	6 - 64	12,5 - 71,0	15,0	18 - 38	0,60	5.26
B07*	10,3	16 - 40	22,5 - 47,0	15,0	18 - 38	0,55	5.30
08	15,0	10 - 50	18,2 - 58,2	19,3	25 - 48	1,00	5.34
B09*	14,3	16 - 40	24,2 - 48,2	19,3	28 - 48	1,00	5.38

*Two-piece - Snap-open along outer radius with film-hinge



Twist and click



Twist and separate



igus® micro E-Chains® - for smallest bending radii with Chainflex® CF98 and CF99 - 4 x d!



B07 and B09: two-piece - Snap-open along outer radius with film-hinge





Price index



IPA Qualification Certificate:
Cleanroom test
upon request



Special equipment:
Electrically conductive ESD/ATEX
version upon request



UL94-V2 classifications
upon request



Smallest inner heights 5 mm:
Series 03 E2 micro



Easy to assemble and to disassemble

**When to use the Series 03:**

- If quiet operation is required
- If price is an issue
- If snap-open links are not necessary
- If small bending radii are required

**When not to use it:**

- If snap-open links are required
 - ▶ **Series 047 Zipper**, page 4.6
- If quick insertion of cables with preassembled connectors is required
 - ▶ **Series E03 Easy Chain**®, page 3.8

**Order example complete E-Chain®**Please indicate chain-lengths or number of links **Example: 1 m or 100 links**

1 m 03.05.028.0



E-Chain®

1 set 03.05.12Z



Mounting bracket

- ❶ igus® smallest E-Chain® - interior dimensions 5 x 5 mm
 - ❷ Very light weight - low price
 - ❸ Mounting bracket with integrated strain relief
 - ❹ Dirt-repellent exterior
 - ❺ Patented "push-button principle" for better stability
 - ❻ One-piece, non snap-open E-Chain®
 - ❼ Available as "Easy Type", easy to be filled
- ▶ page 3.6



Unsupported length

FL_G = with straight upper run

FL_B = with permitted sag

Further information ► Design, page 1.12

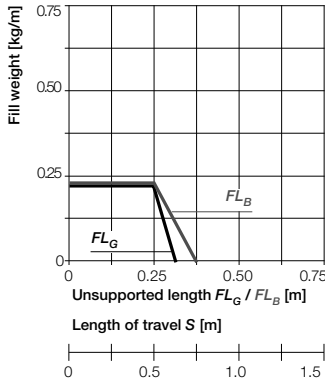
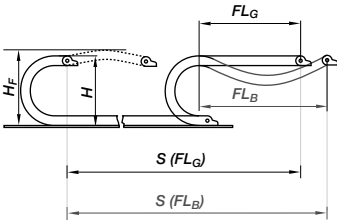

- S = Length of travel
- R = Bending radius
- H = Nominal clearance height
- H_F = Required clearance height
- D = Overlength E-Chain® radius in final position
- $K = \pi \cdot R + \text{"safety"}$

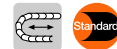
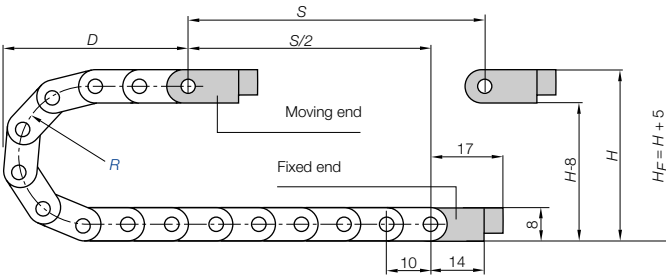

Short travels - unsupported

Unsupported E-Chains® feature positive camber over short travels. This must be accounted for when specifying the clearance height H_F . Please consult igus® if space is particularly restricted.

Pitch = 10 mm/link Links/m = 100 (1.000 mm) Chain length = $S/2 + K$

R	010	012	015	018	028
H	30	34	40	46	66
D	25	27	30	33	43
K	55	60	70	80	110

The required clearance height:
 $H_F = H + 5$ mm
 (with 0,1 kg/m fill weight)

Speed / acceleration FL_G	max. 20 [m/s] / max. 200 [m/s ²]
Speed / acceleration FL_B	max. 3 [m/s] / max. 6 [m/s ²]
Gliding speed / acceleration (maximum)	max. 3 [m/s] / max. 10 [m/s ²]
Material - permitted temperature °C	igumid NB / -40° up to +80° C
Flammability class, igumid NB	VDE 0304 IIC UL94 V2

Technical Data



Details of material properties

► chapter 1



E2 micro
Inner height: 5 mm

Phone +49- (0) 22 03-96 49-800
Fax +49- (0) 22 03-96 49-222



► page 5.9

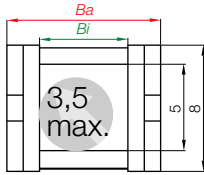

Part No. structure

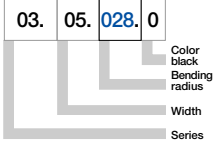

Series 03 E-Chain® - non snap-open

Part No.	Bi [mm]	Ba [mm]	R [mm]	Bending radii	Weight [kg/m]
03.05. <input type="text"/> .0	5	8,7	<input type="text"/> 010	<input type="text"/> 012 <input type="text"/> 015 <input type="text"/> 018 <input type="text"/> 028	≈ 0,04
03.07. <input type="text"/> .0	7	10,7	<input type="text"/> 010	<input type="text"/> 012 <input type="text"/> 015 <input type="text"/> 018 <input type="text"/> 028	≈ 0,05
03.10. <input type="text"/> .0	10	13,7	<input type="text"/> 010	<input type="text"/> 012 <input type="text"/> 015 <input type="text"/> 018 <input type="text"/> 028	≈ 0,06

Supplement Part No. with required radius. Example: 03.05. 028 .0

0 = standard color, other colors ► page 1.39 · Pitch = 10 mm/link - Links/m = 100





Polymer, one-piece

- One-piece mounting bracket
- Corrosion-resistant
- Available preassembled
- Adapter plate for rapid installation

Moving end with bore
(outer link) 03...1Z

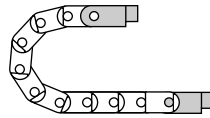

03...2Z Fixed end
with pin (inner link)

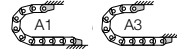

Possible installation conditions for assembled mounting brackets ▶ Order example "preassembled" below

03...1Z

Moving end

03...2Z

Fixed end

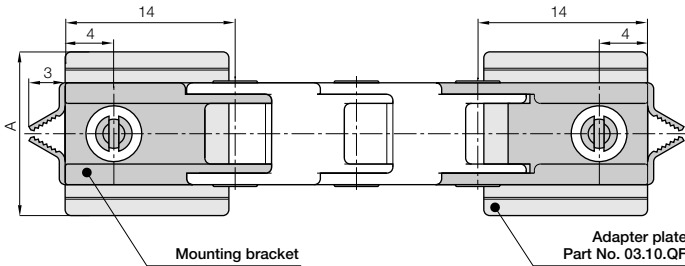

Mounting bracket

Adapter plate
Part No. 03.10.QF

For E-Chain*	Part No. full set	Dim. A [mm]
03.05. ▶	03.05. 12Z	8,7
03.07. ▶	03.07. 12Z	10,7
03.10. ▶	03.10. 12Z	13,7

For the **preassembled** mode please add the index **A1** or **A3** e.g. 03.05. **12Z** **A1**

03.10.QF = Adapter plate for all sizes

The adapter has broken edges, so that it can be adapted to the respective chain width. It is not absolutely necessary for attaching the mounting brackets. The mounting brackets can also be screwed on without the adapter plate.

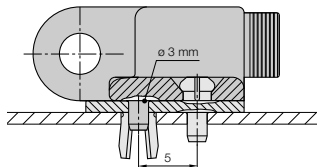

Dimensions and order configurations

Part No. structure

03. 05. 12Z A1

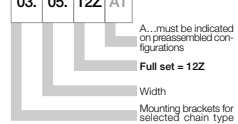

Full set, for both ends:

03. 05. **12Z**

Single-part order:

03. 05. **1Z**

Mounting bracket with bore

03. 05. **2Z**

Mounting bracket with pin



Adapter plate for rapid installation, upon request Part No. 03.10.QF

Additional Features

Phone +49- (0) 22 03-96 49-800
Fax +49- (0) 22 03-96 49-222



▶ page 5.9



Price index



IPA Qualification Certificate:
Cleanroom test
upon request



Special equipment:
Electrically conductive ESD/ATEX
version upon request



UL94-V2 classifications
upon request



Easy to assemble and to disassemble

**When to use the Series 04:**

- If quiet operation is required
- If price is an issue
- If snap-open links are not necessary
- If small bending radii are required

**When not to use it:**

- If snap-open links are required
 - ▶ Series 047 Zipper, page 4.6
- If quick insertion of cables with preassembled connectors is required
 - ▶ Series E04 Easy Chain®, page 3.10

- ① Small E-Chain® - interior dimensions 7 x 7 mm
- ② Very light weight - low price
- ③ Dirt-repellent exterior
- ④ One-piece, non snap-open E-Chain®
- ⑤ Snap-open configuration
- ▶ Series 047 Zipper page 4.6
- ⑥ Easy to fill configuration
- ▶ Series E04 Easy Chain® page 3.10

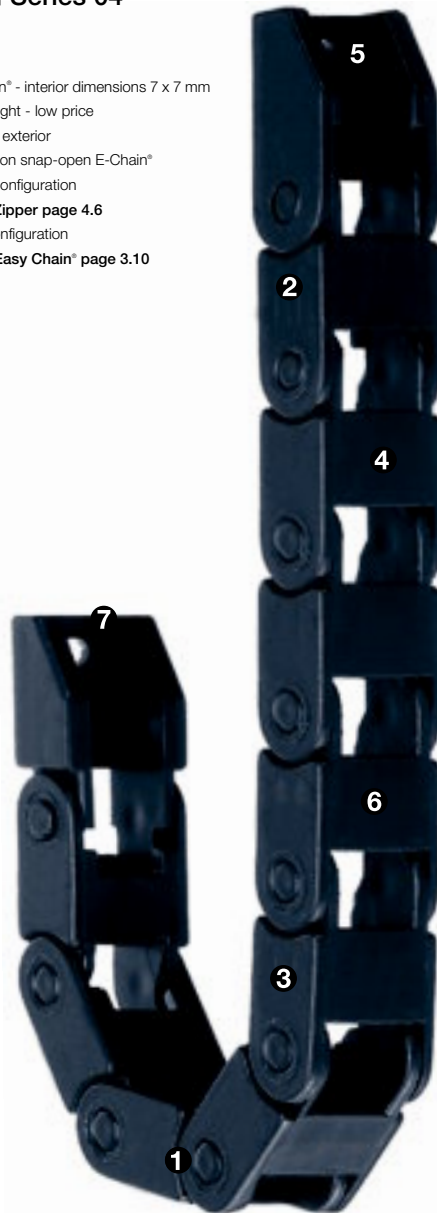
**Order example complete E-Chain®**Please indicate chain-lengths or number of links **Example: 1 m or 60 links**

1 m 04.07.038.0



E-Chain®

1 set 040.07.12



Mounting bracket



Unsupported length

FL_G = with straight upper run

FL_B = with permitted sag

Further information ► Design, page 1.12

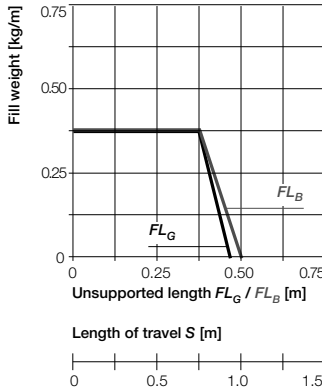
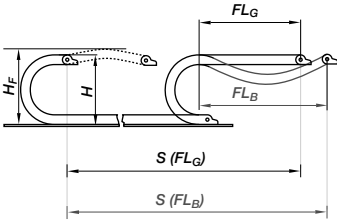

- S = Length of travel
- R = Bending radius
- H = Nominal clearance height
- H_F = Required clearance height
- D = Overlength E-Chain® radius in final position
- $K = \pi \cdot R + \text{"safety"}$

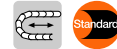
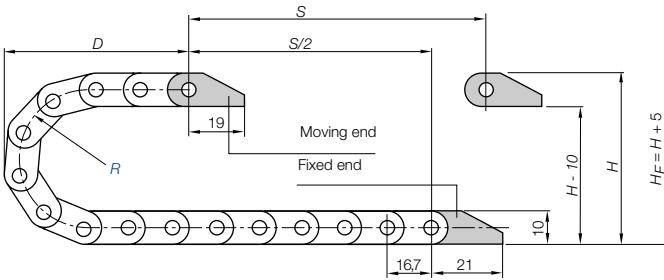

Short travels - unsupported

Unsupported E-Chains® feature positive camber over short travels. This must be accounted for when specifying the clearance height H_F . Please consult igus® if space is particularly restricted.

Pitch = 16,7 mm/link Links/m = 60 (1.002 mm) Chain length = $S/2 + K$

R	015	018	028	038	048
H	42	48	68	88	108
D	40	40	50	60	70
K	80	90	125	155	185

The required clearance height:
 $H_F = H + 5$ mm
 (with 0,1 kg/m fill weight)

Speed / acceleration FL_G	max. 20 [m/s] / max. 200 [m/s ²]
Speed / acceleration FL_B	max. 3 [m/s] / max. 6 [m/s ²]
Gliding speed / acceleration (maximum)	max. 3 [m/s] / max. 10 [m/s ²]
Material - permitted temperature °C	igumid G / -40° up to +120° C
Flammability class, igumid G	VDE 0304 IIC UL94 HB

Technical Data



Details of material properties
 ► page 1.38



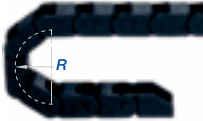
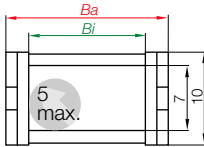

Series 04 E-Chain® - non snap-open

Part No.	<i>Bl</i> [mm]	<i>Ba</i> [mm]	<i>R</i> [mm]	Bending radii					Weight [kg/m]
04.07. <input type="text"/> .0	7	12	<input type="text"/> 015	<input type="text"/> 018	<input type="text"/> 028	<input type="text"/> 038	<input type="text"/> 048	≈ 0,07	
04.10. <input type="text"/> .0	10	15	<input type="text"/> 015	<input type="text"/> 018	<input type="text"/> 028	<input type="text"/> 038	<input type="text"/> 048	≈ 0,08	
04.16. <input type="text"/> .0	16	21	<input type="text"/> 015	<input type="text"/> 018	<input type="text"/> 028	<input type="text"/> 038	<input type="text"/> 048	≈ 0,09	
04.20. <input type="text"/> .0	20	25	<input type="text"/> 015	<input type="text"/> 018	<input type="text"/> 028	<input type="text"/> 038	<input type="text"/> 048	≈ 0,10	
04.30. <input type="text"/> .0	30	35	<input type="text"/> 015	<input type="text"/> 018	<input type="text"/> 028	<input type="text"/> 038	<input type="text"/> 048	≈ 0,11	

Supplement Part No. with required radius. Example: 04.07.038.0

0 = standard color, other colors ► page 1.39 · Pitch = 16,7 mm/link - Links/m = 60

Part No. structure

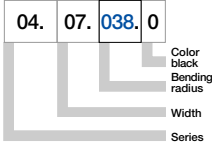



Price index



IPA Qualification Certificate:
Cleanroom test
upon request



Special equipment:
Electrically conductive ESD/ATEX
version upon request



UL94-V2 classifications
upon request



Easy to assemble and to disassemble



When to use the Series 045:

- If very quiet operation is required
- Aesthetic design
- If excellent service life is required
- If price is an issue
- If small bending radii are required



When not to use it:

- If snap-open links are required
 - ▶ Series 047 Zipper, page 4.6
- If quick insertion of cables with preassembled connectors is required
 - ▶ Series E06 Easy Chain®, page 3.20
- If extra rigidity is required
 - ▶ Series 06 E2 micro, page 5.26

- ① Small pitch for very quiet operation
- ② Very light weight -
ideal for low inertia applications
- ③ Dirt-repellent exterior
- ④ One-piece, non snap-open E-Chain®
- ⑤ Easy to fill configuration
- ▶ Series E06 Easy Chain® page 3.20
- ⑥ Snap-open configuration
- ▶ Series 047 Zipper page 4.6



Series 046 with full-width shelving
046.16.018, 046.16.028, 046.16.038 available.
Width B: 16 mm - Radii R: 018, 028, 038



Order example complete E-Chain®

Please indicate chain-lengths or number of links Example: 1 m or 77 links

1 m 045.20.038.0



E-Chain®

1 set 0450.20.12



Mounting bracket



Unsupported length

FL_G = with straight upper run

FL_B = with permitted sag

Further information ► Design, page 1.12

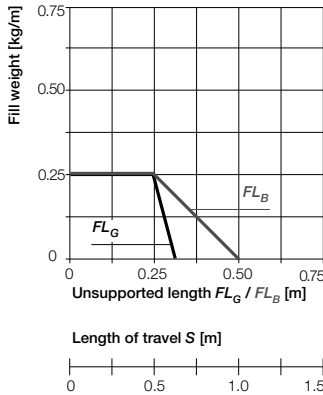
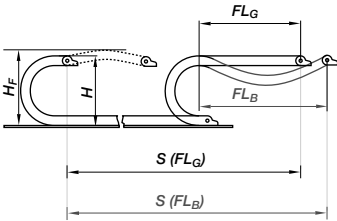

- S = Length of travel
- R = Bending radius
- H = Nominal clearance height
- H_F = Required clearance height
- D = Overlength E-Chain® radius in final position
- $K = \pi \cdot R + \text{"safety"}$

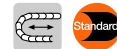
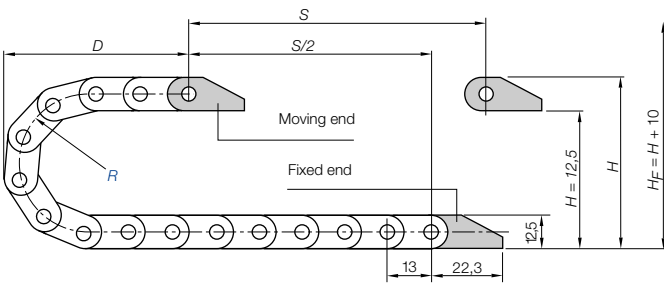

Short travels - unsupported

Unsupported E-Chains® feature positive camber over short travels. This must be accounted for when specifying the clearance height H_F . Please consult igus® if space is particularly restricted.

Pitch = 13 mm/link Links/m = 77 (1.001 mm) Chain length = $S/2 + K$

	018	028	038
R			
H	52	72	92
D	45	55	65
K	100	140	160

The required clearance height:
 $H_F = H + 10$ mm
 (with 0.2 kg/m fill weight)

10,3

E2 micro
Inner height: 10,3 mm

Phone +49- (0) 22 03-96 49-800
Fax +49- (0) 22 03-96 49-222

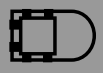

► page 5.9

Speed / acceleration FL_G	max. 20 [m/s] / max. 200 [m/s ²]
Speed / acceleration FL_B	max. 3 [m/s] / max. 6 [m/s ²]
Gliding speed / acceleration (maximum)	max. 3 [m/s] / max. 10 [m/s ²]
Material - permitted temperature °C	igumid G / -40° up to +120° C
Flammability class, igumid G	VDE 0304 IIC UL94 HB

Technical Data



Details of material properties
 ► page 1.38

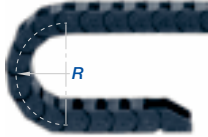
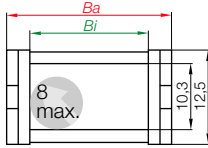

Series 045 E-Chain® - non snap-open

Part No.	Bi [mm]	Ba [mm]	R [mm]	Bending radii	Weight [kg/m]
045.06.□.0	6	12	018	028 038	~ 0,09
045.10.□.0	10	16	018	028 038	~ 0,10
045.16.□.0	16	22	018	028 038	~ 0,11
045.20.□.0	20	26	018	028 038	~ 0,13
045.30.□.0	30	36	018	028 038	~ 0,16
045.64.□.0	64	70	018	028 038	~ 0,19

Supplement Part No. with required radius. Example: 045.20.038.0

0 = standard color, other colors ► page 1.39 · Pitch = 13 mm/link - Links/m = 77

Part No. structure

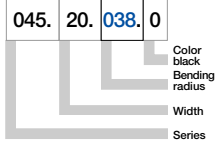



Polymer, one-piece

- One-piece mounting bracket
- Corrosion-resistant
- Available preassembled
- Inner and outer attachment possible

Moving end with bore
(outer link) 0450...1(PZ)

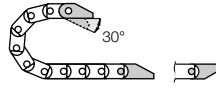

0450...2(PZ) Fixed end
with pin (inner link)

Possible installation conditions for assembled mounting brackets ▶ Order example "preassembled" below

0450...1(PZ)
Moving end

0450...2(PZ)
Fixed end

Dimensions and order configurations

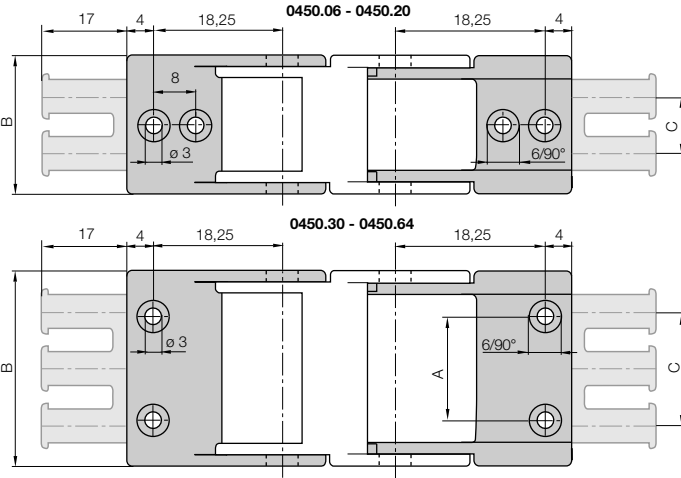

For E-Chain*	Part No. full set tiewrap plate	Part No. full set zahl tiewrap plate	Number of teeth	Dim. A [mm]	Dim. B [mm]	Dim. C [mm]
045.06. ▶	0450.06. 12 PZ	0450.06. 12	1	-	12	-
045.10. ▶	0450.10. 12 PZ	0450.10. 12	1	-	16	-
045.16. ▶	0450.16. 12 PZ	0450.16. 12	2	-	22	10
045.20. ▶	0450.20. 12 PZ	0450.20. 12	2	-	26	10
045.30. ▶	0450.30. 12 PZ	0450.30. 12	3	22	36	20
045.64. ▶	0450.64. 12 PZ	0450.64. 12	6	56	70	50

For the **preassembled** mode please add the index 0450.20. 12 PZ[A1]

The mounting brackets are available upon request. Time of delivery approx. 6-8 weeks after order.

Part No. structure

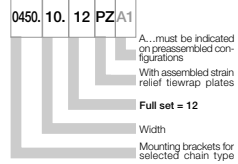

Full set, for both ends:

0450. 10. 12 | PZ | +tiewrap plate

Single-part order:

0450. 10. 1 | PZ | +tiewrap plate

Mounting bracket **with bore**

0450. 10. 2 | PZ | +tiewrap plate

Mounting bracket **with pin**

Phone +49- (0) 22 03-96 49-800
Fax +49- (0) 22 03-96 49-222





Price index



IPA Qualification Certificate:
Cleanroom test
upon request



Special equipment:
Electrically conductive ESD/ATEX
version upon request



UL94-V2 classifications
upon request



iF-Design Award -
for E2 micro-Series 05



Easy to assemble and to disassemble



When to use the Series 05:

- If light weight construction is required
- If minimal height and width dimensions are required
- If price is an issue



When not to use it:

- If snap-open links are required
 - ▶ Series 07 Zipper, page 4.10
- If quick insertion of cables with preassembled connectors is required
 - ▶ Series E06 Easy Chain®, page 3.20
- If extra rigidity is required
 - ▶ Series 06 E2 micro, page 5.26

- ① Very light weight -
ideal for low inertia applications
- ② iF-Design Award
- ③ One-piece, non snap-open E-Chain®
- ④ Snap-open configuration
 - ▶ Series 07 Zipper, page 4.10
 - ▶ Series R07 Zipper Tube, page 4.28
- ⑤ Easy to fill configuration
 - ▶ Series E06 Easy Chain®, page 3.20



Order example complete E-Chain®

Please indicate chain-lengths or number of links Example: 1 m or 50 links

1 m 05.20.038.0



E-Chain®

1 set 050.20.12



Mounting bracket



Unsupported length

FL_G = with straight upper run

FL_B = with permitted sag

Further information ► Design, page 1.12

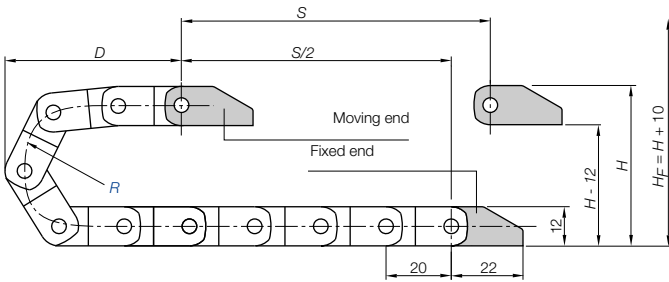
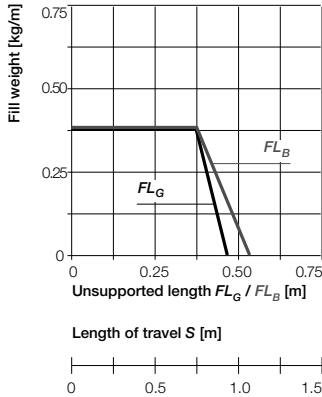
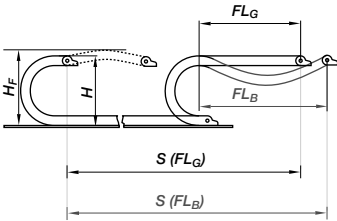

- S = Length of travel
- R = Bending radius
- H = Nominal clearance height
- H_F = Required clearance height
- D = Overlength E-Chain® radius in final position
- $K = \pi \cdot R + \text{"safety"}$



Short travels - unsupported

Unsupported E-Chains® feature positive camber over short travels. This must be accounted for when specifying the clearance height H_F . Please consult igus® if space is particularly restricted.

Pitch = 20 mm/link Links/m = 50 (1.000 mm) Chain length = $S/2 + K$

	018	028	038
R			
H	52	72	92
D	45	55	65
K	100	140	160

The required clearance height:
 $H_F = H + 10$ mm
 (with 0.2 kg/m fill weight)

10

E2 micro
Inner height: 10 mm

Phone +49- (0) 22 03-96 49-800
Fax +49- (0) 22 03-96 49-222



Technical Data

Speed / acceleration FL_G	max. 20 [m/s] / max. 200 [m/s ²]
Speed / acceleration FL_B	max. 3 [m/s] / max. 6 [m/s ²]
Gliding speed / acceleration (maximum)	max. 3 [m/s] / max. 10 [m/s ²]
Material - permitted temperature °C	igumid G / -40° up to +120° C
Flammability class, igumid G	VDE 0304 IIC UL94 HB



Details of material properties
 ► page 1.38



► page 5.9

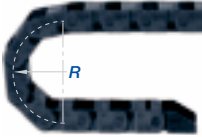
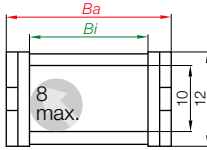

Part No. structure

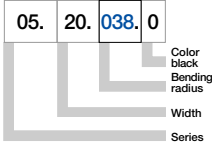

Series 05 E-Chain® - non snap-open

Part No.	Bi [mm]	Ba [mm]	R [mm]	Bending radii	Weight [kg/m]
05.06.□.0	6	10	018	028 038	~ 0,06
05.10.□.0	10	14	018	028 038	~ 0,07
05.16.□.0	16	20	018	028 038	~ 0,07
05.20.□.0	20	24	018	028 038	~ 0,08
05.30.□.0	30	34	018	028 038	~ 0,09
05.64.□.0	64	68	018	028 038	~ 0,19

Supplement Part No. with required radius. Example: 05.20.□038□.0

0 = standard color, other colors ► page 1.39 · Pitch = 20 mm/link - Links/m = 50





Polymer, one-piece

- One-piece mounting bracket
- Corrosion-resistant
- Available preassembled
- Inner and outer attachment possible

Moving end with bore (outer link) 050...1

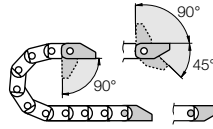

050...2 Fixed end with pin (inner link)



Possible installation conditions for assembled mounting brackets ▶ Order example "preassembled" below

050...1
Moving end

050...2
Fixed end

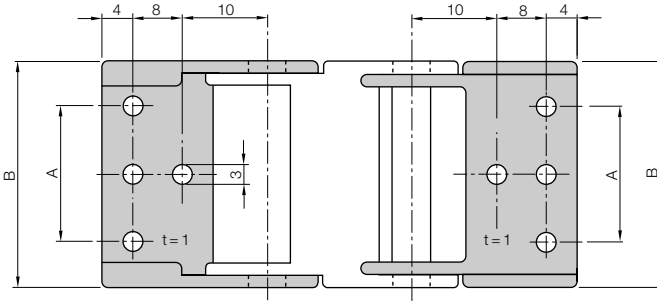

050.06.12 - 050.20.12: center bores only

050.30.12 - 050.64.12: outer bores only

For E-Chain®	Part No. full set	Dim. A [mm]	Dim. B [mm]
05.06. ▶	050.06.12	-	10,7
05.10. ▶	050.10.12	-	14,7
05.16. ▶	050.16.12	-	20,7
05.20. ▶	050.20.12	-	24,7
05.30. ▶	050.30.12	22	34,7
05.64. ▶	050.64.12	56	68,7

For the preassembled mode please add the index **A1 ... A4** e.g. 050.20.12 **A1**

Dimensions and order configurations

Part No. structure

050.	20.	12	A1
------	-----	----	----

A... must be indicated on preassembled configurations

Full set = 12

Width
Mounting brackets for selected chain type

Full set, for both ends:

050.20.12

Single-part order:

050.20.1

Mounting bracket with bore

050.20.2

Mounting bracket with pin

Phone +49- (0) 22 03-96 49-800
Fax +49- (0) 22 03-96 49-222



▶ page 5.9



Price index



IPA Qualification Certificate:
Cleanroom test
upon request



Special equipment:
Electrically conductive ESD/ATEX
version upon request



UL94-V2 classifications
upon request



Easy to assemble and to disassemble



When to use the Series 06:

- High torsional rigidity
- If price is an issue
- If connection options are required
(Quicksnap, Quickfix, ...)



When not to use it:

- If snap-open links are required
 - ▶ Series 07 Zipper, page 4.10
 - ▶ Series B07 E2 micro, page 5.30
- If quick insertion of cables with preassembled connectors is required
 - ▶ Series E06 Easy Chain®, page 3.20
- If very quiet operation is required
 - ▶ Series 045 E2 micro, page 5.18

- ① High torsional rigidity
- ② Very light weight - low price
- ③ Dirt-repellent exterior
- ④ Mounting bracket with integrated strain relief
- ⑤ Easy to fill configuration
- ▶ Series E06 Easy Chain®, page 3.20
- ⑥ Snap-open configuration
- ▶ Series 07 Zipper, page 4.10
- ▶ Series B07 E2 micro, page 5.30
- ⑦ Molded-in separator available
Series 06.16.018.S1



Order example complete E-Chain®

Please indicate chain-lengths or number of links Example: 1 m or 50 links

1 m 06.20.038.0



E-Chain®

1 set 060.20.12PZ



Mounting bracket



Unsupported length

FL_G = with straight upper run

FL_B = with permitted sag

Further information ► Design, page 1.12

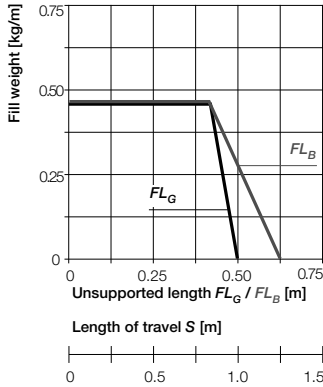
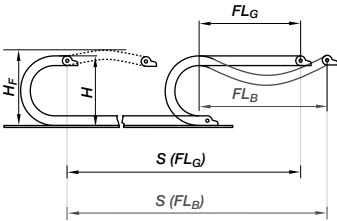

- S = Length of travel
- R = Bending radius
- H = Nominal clearance height
- H_F = Required clearance height
- D = Overlength E-Chain® radius in final position
- $K = \pi \cdot R + \text{"safety"}$

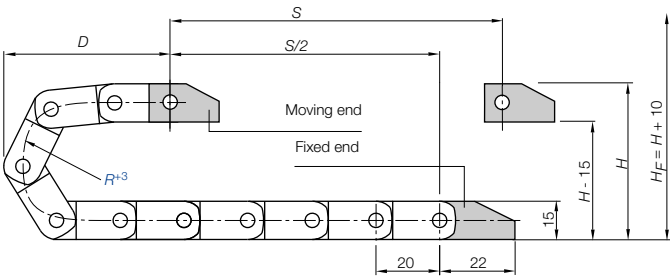

Short travels - unsupported

Unsupported E-Chains® feature positive camber over short travels. This must be accounted for when specifying the clearance height H_F . Please consult igus® if space is particularly restricted.

Pitch = 20 mm/link Links/m = 50 (1.000 mm) Chain length = $S/2 + K$

	018	028	038
R			
H	52	72	92
D	45	55	65
K	100	140	160

The required clearance height:
 $H_F = H + 10 \text{ mm}$
 (with 0.2 kg/m fill weight)

10,5

E2 micro
Inner height: 10,5 mm

Phone +49- (0) 22 03-96 49-800
Fax +49- (0) 22 03-96 49-222

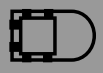

► page 5.9

Speed / acceleration FL_G	max. 20 [m/s] / max. 200 [m/s ²]
Speed / acceleration FL_B	max. 3 [m/s] / max. 6 [m/s ²]
Gliding speed / acceleration (maximum)	max. 3 [m/s] / max. 10 [m/s ²]
Material - permitted temperature °C	igumid G / -40° up to +120° C
Flammability class, igumid G	VDE 0304 IIC UL94 HB

Technical Data



Details of material properties
 ► page 1.38

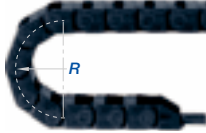
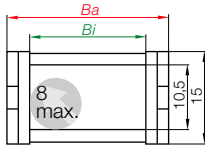

Series 06 E-Chain® - non snap-open

Part No.	Bi [mm]	Ba [mm]	R [mm]	Bending radii	Weight [kg/m]
06.06.□.0	6	12,5	018 028 038		≈ 0,13
06.10.□.0	10	16,5	018 028 038		≈ 0,14
06.16.□.0	16	22,5	018 028 038		≈ 0,16
06.20.□.0	20	27,0	018 028 038		≈ 0,17
06.30.□.0	30	37,0	018 028 038		≈ 0,20
06.40.□.0	40	47,0	018 028 038		≈ 0,23
06.50.□.0	50	57,0	018 028 038		≈ 0,26
06.64.□.0	64	71,0	018 028 038		≈ 0,30

Supplement Part No. with required radius. Example: 06.20.□.038.0

0 = standard color, other colors ► page 1.39 · Pitch = 20 mm/link - Links/m = 50

Part No. structure

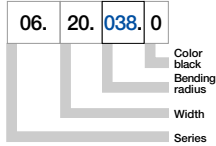



Polymer, one-piece

- One-piece mounting bracket
- Corrosion-resistant
- Available preassembled
- Inner and outer attachment possible
- Available with or without strain relief tiewrap plates

Moving end with bore
(outer link) 060...1(PZ)

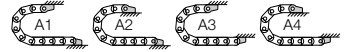
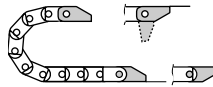

060...2(PZ) Fixed end
with pin (inner link)

Possible installation conditions for assembled mounting brackets ▶ Order example "preassembled" below

060...1(PZ)
Moving end

060...2(PZ)
Fixed end

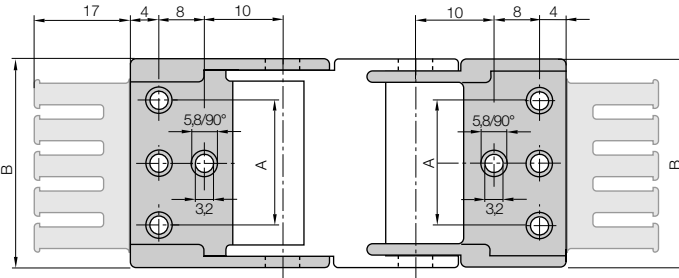

060.06.12 - 060.20.12: center bores only
060.30.12 - 060.64.12: outer bores only

For E-Chain®	Part No. full set with tiewrap plate	Part No. full set without tiewrap plate	Number of teeth	Dim. A [mm]	Dim. B [mm]
06.06. ▶	060.06. 12 PZ	060.06. 12	1	-	12,5
06.10. ▶	060.10. 12 PZ	060.10. 12	1	-	16,5
06.16. ▶	060.16. 12 PZ	060.16. 12	2	-	22,5
06.20. ▶	060.20. 12 PZ	060.20. 12	2	-	27,0
06.30. ▶	060.30. 12 PZ	060.30. 12	3	22	37,0
06.40. ▶	060.40. 12 PZ	060.40. 12	4	32	47,0
06.50. ▶	060.50. 12 PZ	060.50. 12	5	42	57,0
06.64. ▶	060.64. 12 PZ	060.64. 12	6	56	71,0

For the preassembled mode please add the index A1 ... A4 e.g. 060.20. 12 PZ A1

Dimensions and order configurations

Strain relief is possible on the moving end and/or the fixed end.

Part No. structure

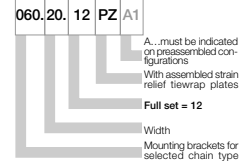

Full set, for both ends:
060.20. 12 PZ +tiewrap plate

Single-part order:
060.20. 1 PZ +tiewrap plate

Mounting bracket with bore
060.20. 2 PZ +tiewrap plate

Mounting bracket with pin



Quicksnap - the complete, detachable mounting unit, upon request
Part No. 060.10.QS, Art. Nr. 060.16.QS,
Part No. 060.20.QS, Art. Nr. 060.40.QS



Quickfix - mounting bracket with dowel, upon request

Additional Features

Phone +49- (0) 22 03-96 49-800
Fax +49- (0) 22 03-96 49-222



● ● ● Price index



UL94-V2 classifications
upon request



Special equipment:
Electrically conductive ESD/ATEX
version upon request

- ❶ Snap-open along outer radius with film-hinge
 - ❷ Small pitch for low-noise, smooth operation
 - ❸ For high acceleration
 - ❹ Light weight
 - ❺ Mounting bracket with integrated strain relief
 - ❻ Modular 2-piece link design - saves assembly time
 - ❼ Easy to shorten and lengthen at any given point
 - ❽ Closed, easy to open version
- ▶ Series R07 Zipper E-Tube, page 4.28



Easy to assemble and to disassemble



When to use the Series B07:

- If a small and lightweight E-Chain® is required
- If an openable small and reasonable E-Chain® is required
- Perfect for handling machines and pick and place robots



When not to use it:

- If opening of the link is not necessary
 - ▶ Series 06 E2 micro, page 5.26
- If cable installation without opening lids is possible
 - ▶ Series E06 Easy Chain®, page 3.20
- If a fast openable E-Tube system is required
 - ▶ Series R07, page 4.28

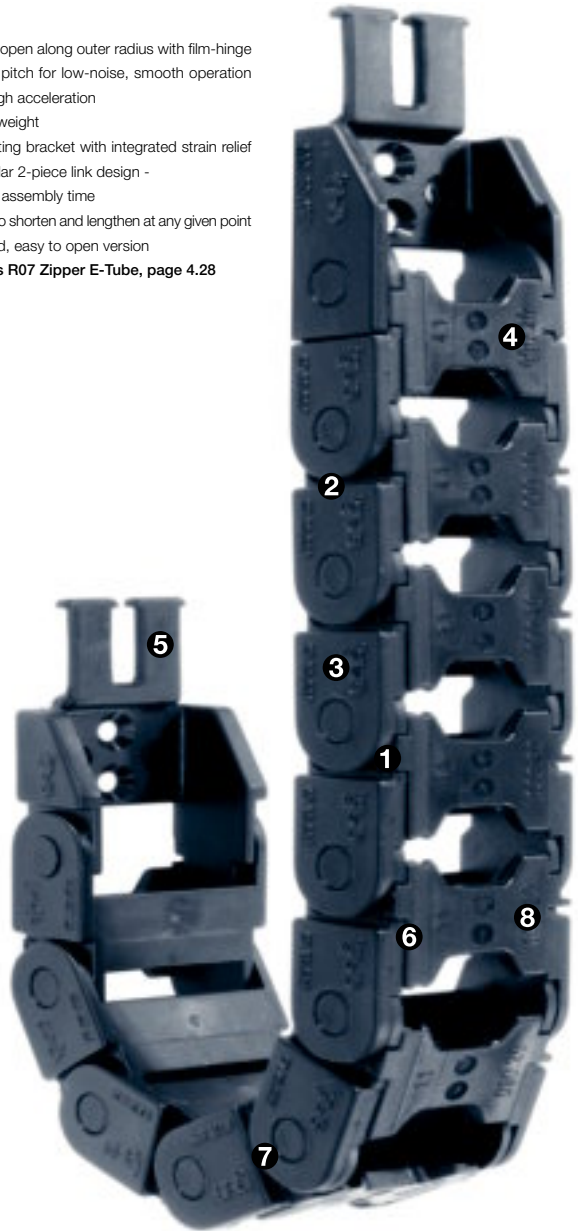

Order example complete E-Chain®

Please indicate chain-lengths or number of links Example: 1 m or 50 links

1 m B07.20.038.0



E-Chain®

1 set 060.20.12PZ



Mounting bracket



Unsupported length

FL_G = with straight upper run

FL_B = with permitted sag

Further information ► Design, page 1.12

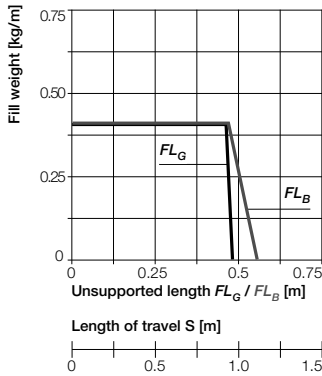
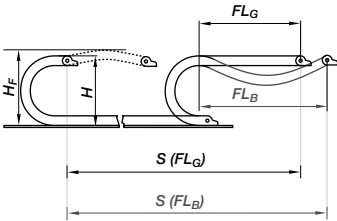

- S = Length of travel
- R = Bending radius
- H = Nominal clearance height
- H_F = Required clearance height
- D = Overlength E-Chain® radius in final position
- $K = \pi \cdot R + \text{"safety"}$

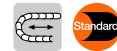
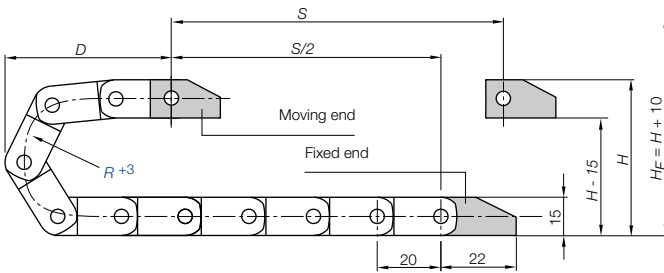

Short travels - unsupported

Unsupported E-Chains® feature positive camber over short travels. This must be accounted for when specifying the clearance height H_F . Please consult igus® if space is particularly restricted.

Pitch = 20 mm/link Links/m = 50 (1.000 mm) Chain length = $S/2 + K$

R	018	028	038
H	52	72	92
D	45	55	65
K	100	140	160

The required clearance height:
 $H_F = H + 10$ mm
 (with 0.2 kg/m fill weight)

Speed / acceleration FL_G	max. 20 [m/s] / max. 200 [m/s ²]
Speed / acceleration FL_B	max. 3 [m/s] / max. 6 [m/s ²]
Gliding speed / acceleration (maximum)	max. 10 [m/s] / max. 50 [m/s ²]
Material - permitted temperature °C	igumid G / -40° to +120° C
Flammability class, igumid G	VDE 0304 IIC UL94 HB

Technical Data



Details of material properties
 ► page 1.38



E2 micro
 Inner height: 10,3 mm

Phone +49- (0) 22 03-96 49-800
 Fax +49- (0) 22 03-96 49-222



► page 5.9

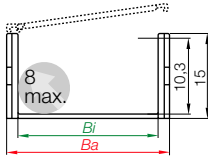

Part No. structure

B07.	20.	038.	0
------	-----	------	---



Series B07 - snap-open along inner radius

Part No.	Bi [mm]	Ba [mm]	R [mm]	Bending Radii			Weight [kg/m]
B07.16.	16	22,5	018	028	038	≈ 0,16	
B07.20.	20	27	018	028	038	≈ 0,17	
B07.30.	30	37	018	028	038	≈ 0,20	
B07.40.	40	47	018	028	038	≈ 0,23	

Supplement part no. with required radius (R) Example: B07.20.038.0

0 = standard color, other colors ► page 1.39 · Pitch = 20 mm/link - Links/m = 50





Polymer, one-piece

- One-piece mounting bracket
- Corrosion-resistant
- Available preassembled
- Inner and outer attachment possible
- Available with or without integrated strain relief tiwrap plates

Moving end with bore
(outer link) 060...1(PZ)

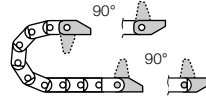

060...2(PZ) Fixed end
with pin (inner link)

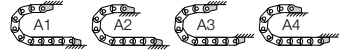

Possible installation conditions for assembled mounting brackets ▶ Order example "preassembled" below

060...1(PZ)

Moving end

060...2(PZ)

Fixed end

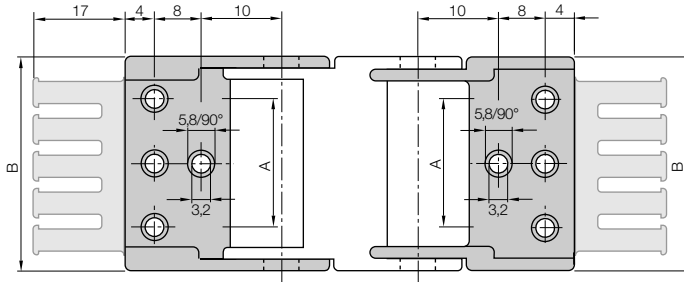

060.16.12 - 060.20.12: center bores only

060.30.12 - 060.40.12: outer bores only

For E-chain®	Part No. full set with tiwrap plate	Part No. full set without tiwrap plate	Number of teeth	Dim. A [mm]	Dim. B [mm]
B07.16. ▶	060.16. 12 PZ	060.16. 12	2	-	22,5
B07.20. ▶	060.20. 12 PZ	060.20. 12	2	-	27,0
B07.30. ▶	060.30. 12 PZ	060.30. 12	3	22	37,0
B07.40. ▶	060.40. 12 PZ	060.40. 12	4	32	47,0

For the **preassembled** mode please add the index **A1** ... **A4** Example: 060.06. 12 PZ **A1**

Dimensions and order configurations

Strain relief is possible on the moving end and/or the fixed end.

Part No. structure

060. 16. 12 PZ A1

A... must be indicated on preassembled configurations with assembled tiwrap plates

Full set = 12

Width Mounting brackets for selected chain type

Full set, for both ends:

060.16. 12 PZ +tiwrap plate

Single-part order:

060.16. 1 PZ +tiwrap plate

Mounting bracket **with bore**

060.16. 2 PZ +tiwrap plate

Mounting bracket **with pin**



Quicksnap - the complete, detachable mounting unit, available upon request

Quickfix - mounting bracket with dowel, available upon request

Additional Features

Phone +49- (0) 22 03-96 49-800
Fax +49- (0) 22 03-96 49-222





Price index



IPA Qualification Certificate:
Cleanroom test
upon request



Special equipment:
Electrically conductive ESD/ATEX
version upon request



UL94-V2 classifications
upon request



Easy to assemble and to disassemble



When to use the Series 08:

- If quiet operation is required
- If price is an issue
- If connection options are required
(Quicksnap, Quickfix, ...)
- If high torsional rigidity is required



When not to use it:

- If snap-open links are required
 - ▶ Series 09 Zipper, page 4.14
 - ▶ Series B09 E2 micro, page 5.38
- If quick insertion of cables with preassembled connectors is required
 - ▶ Series E08 Easy Chain®, page 3.28

- ① Small pitch for very quiet operation
 - ② High torsional rigidity
 - ③ Very light weight - low price
 - ④ Dirt-repellent exterior
 - ⑤ Mounting brackets with strain relief options
 - ⑥ One piece each link
 - ⑦ Easy to fill configuration
- ▶ Series E08 Easy Chain®, page 3.28
 - ⑧ Snap-open configuration
 - ▶ Series 09 Zipper, page 4.14
 - ▶ Series B09 E2 micro, page 5.38
 - ⑨ Fully enclosed E-Tube
 - ▶ Series R09 Zipper Tube, page 4.32



Order example complete E-Chain®

Please indicate chain-lengths or number of links Example: 1 m or 50 links

1 m 08.30.038.0



E-Chain®

1 set 080.30.12PZ



Mounting bracket



Unsupported length

FL_G = with straight upper run

FL_B = with permitted sag

Further information ► Design, page 1.12

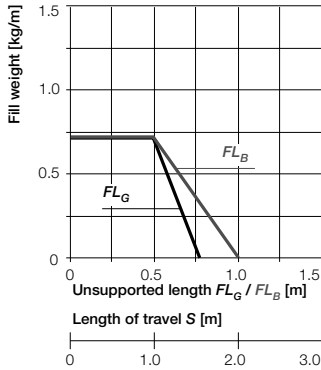
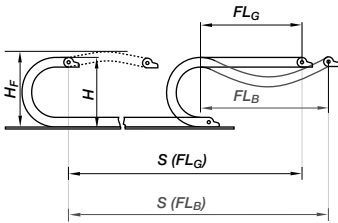

- S = Length of travel
- R = Bending radius
- H = Nominal clearance height
- H_F = Required clearance height
- D = Overlength E-Chain® radius in final position
- $K = \pi \cdot R + \text{"safety"}$

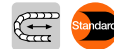
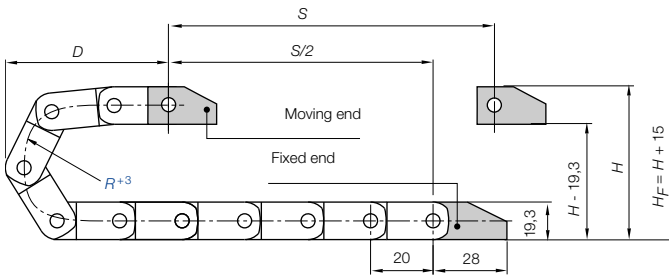

Short travels - unsupported

Unsupported E-Chains® feature positive camber over short travels. This must be accounted for when specifying the clearance height H_F . Please consult igus® if space is particularly restricted.

Pitch = 20 mm/link Links/m = 50 (1.000 mm) Chain length = $S/2 + K$

R	025*	028	038	048
H	70	76	96	116
D	57	60	70	80
K	120	130	160	190

*Radius 025 only for Part No. 08.10

The required clearance height:
 $H_F = H + 15 \text{ mm}$
 (with 0,3 kg/m fill weight)

15

E2 micro
Inner height: 15 mm

Phone +49- (0) 22 03-96 49-800
Fax +49- (0) 22 03-96 49-222



Technical Data

Speed / acceleration FL_G	max. 20 [m/s] / max. 200 [m/s ²]
Speed / acceleration FL_B	max. 3 [m/s] / max. 6 [m/s ²]
Gliding speed / acceleration (maximum)	max. 3 [m/s] / max. 10 [m/s ²]
Material - permitted temperature °C	igumid G / -40° up to +120° C
Flammability class, igumid G	VDE 0304 IIC UL94 HB



Details of material properties
► page 1.38



► page 5.9

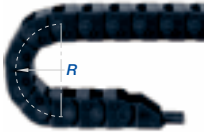
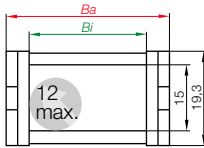

Part No. structure

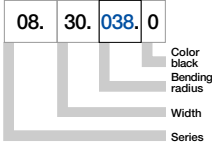

Series 08 E-Chain® - non snap-open

Part No.	Bl [mm]	Ba [mm]	F [mm]	Bending radii	Weight [kg/m]
08.10.□.0	10	18,2	025 028 038 048		≈ 0,21
08.13.□.0	13	21,2	028 038		≈ 0,23
08.16.□.0	16	24,2	028 038 048		≈ 0,24
08.20.□.0	20	28,2	028 038 048		≈ 0,25
08.30.□.0	30	38,2	028 038 048		≈ 0,28
08.40.□.0	40	48,2	028 038 048		≈ 0,31
08.50.□.0	50	58,2	028 038 048		≈ 0,37

Supplement Part No. with required radius. Example: 08.30.038.0

0 = standard color, other colors ► page 1.39 · Pitch = 20 mm/link - Links/m = 50





Polymer, one-piece

- One-piece mounting bracket
- Corrosion-resistant
- Available preassembled
- Inner and outer attachment possible
- Available with or without strain relief tiwrap plates

Moving end with bore
(outer link) 080...1 (PZ)

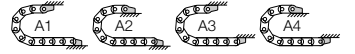
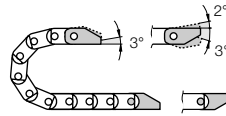

080...2 (PZ) Fixed end
with pin (inner link)

Possible installation conditions for assembled mounting brackets ▶ Order example "preassembled" below

080...1 (PZ)
Moving end

080...2 (PZ)
Fixed end

Dimensions and order configurations

Strain relief is possible on the moving end and/or the fixed end.

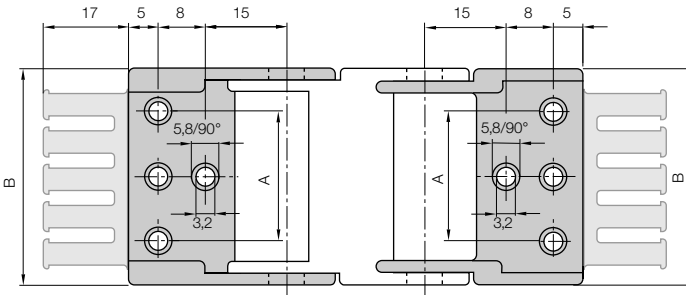

080.06.12 - 080.20.12: center bores only

080.30.12 - 080.50.12: all bores

For E-Chain*	Part No. full set with tiwrap plate	Part No. full set without tiwrap plate	Number of teeth	Dim. A [mm]	Dim. B [mm]
08.10. ▶	080.10. 12 PZ	080.10. 12	1	–	18,2
08.13. ▶	080.16. 12 PZ	080.13. 12	–	–	21,2
08.16. ▶	080.16. 12 PZ	080.16. 12	2	–	24,2
08.20. ▶	080.20. 12 PZ	080.20. 12	2	–	28,2
08.30. ▶	080.30. 12 PZ	080.30. 12	3	22	38,2
08.40. ▶	080.40. 12 PZ	080.40. 12	4	32	48,2
08.50. ▶	080.50. 12 PZ	080.50. 12	5	42	58,2

For the preassembled mode please add the index A1 ... A4 e.g. 080.30. 12 PZ A1

Part No. structure

080.30. 12 PZ A1

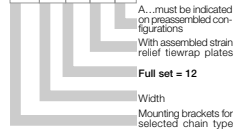

Full set, for both ends:

080.30. 12 PZ +tiwrap plate

Single-part order:

080.30. 1 PZ +tiwrap plate

Mounting bracket with bore

080.30. 2 PZ +tiwrap plate

Mounting bracket with pin



Quicksnap - the complete, detachable mounting unit, upon request

Part No. 080.20.QS, Part No.080.30.QS



Quickfix - mounting bracket with dowel, upon request

Additional Features



▶ page 5.9

● ● ● Price index



UL94-V2 classifications
upon request



Special equipment:
Electrically conductive ESD/ATEX
version upon request

- ① Snap-open along outer radius with film-hinge
 - ② Small pitch for low-noise, smooth operation
 - ③ For high acceleration
 - ④ Light weight
 - ⑤ Mounting bracket with integrated strain relief
 - ⑥ Modular 2-piece link design - saves assembly time
 - ⑦ Easy to shorten and lengthen at any given point
 - ⑧ Closed, easy to open version
- ▶ Series R09 Zipper E-Tube, page 4.32



Easy to assemble and to disassemble



When to use the Series B09:

- If a small and lightweight E-Chain® is required
- If an openable small and reasonable E-Chain® is required
- Perfect for handling machines and pick and place robots



When not to use it:

- If opening of the link is not necessary
 - ▶ Series 08 E2 micro, page 5.34
- If cable installation without opening lids is possible
 - ▶ Series E08 Easy Chain®, page 3.28
- If a fast openable E-Tube system is required
 - ▶ Series R09, page 4.32

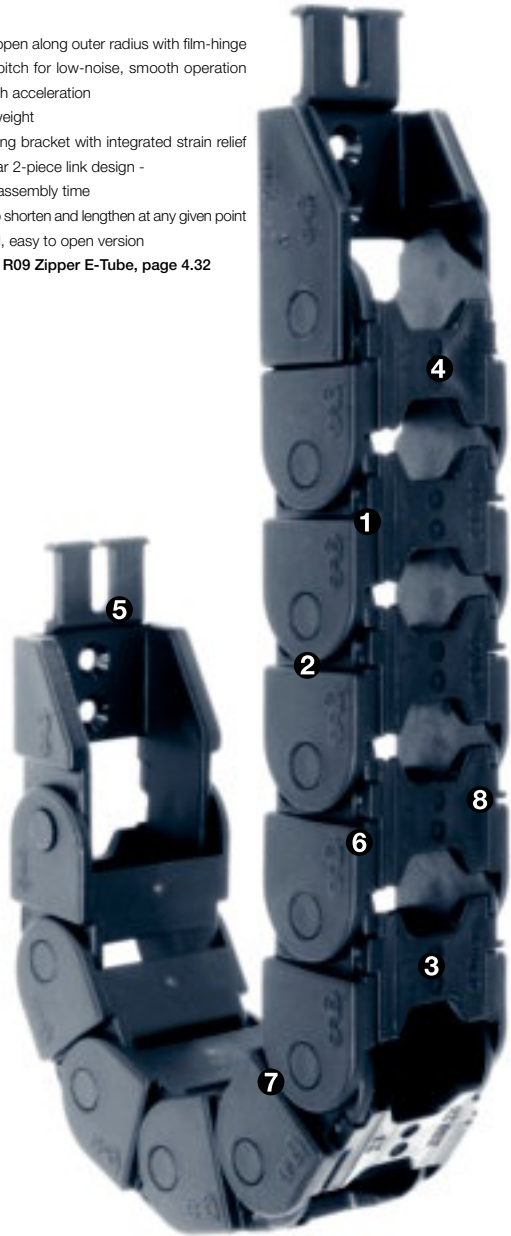

Order example complete E-Chain®

Please indicate chain-lengths or number of links Example: 1 m or 50 links

1 m B09.20.038.0



E-Chain®

1 set 080.20.12PZ



Mounting bracket



Unsupported length

FL_G = with straight upper run

FL_B = with permitted sag

Further information ► Design, page 1.12

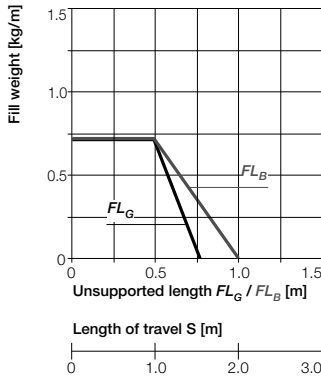
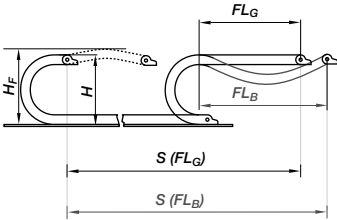

- S = Length of travel
- R = Bending radius
- H = Nominal clearance height
- H_F = Required clearance height
- D = Overlength E-Chain® radius in final position
- $K = \pi \cdot R + \text{"safety"}$

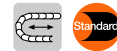
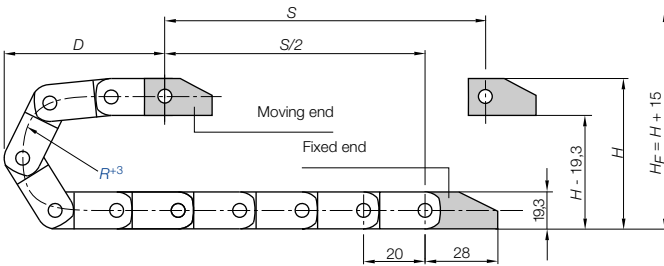

Short travels - unsupported

Unsupported E-Chains® feature positive camber over short travels. This must be accounted for when specifying the clearance height H_F . Please consult igus® if space is particularly restricted.

Pitch = 20 mm/link Links/m = 50 (1.000 mm) Chain length = $S/2 + K$

R	028	038	048
H	76	96	116
D	60	70	80
K	130	160	190

The required clearance height:
 $H_F = H + 15$ mm
 (with 0,3 kg/m fill weight)

Speed / acceleration FL_G	max. 20 [m/s] / max. 200 [m/s]
Speed / acceleration FL_B	max. 3 [m/s] / max. 6 [m/s]
Gliding speed / acceleration (maximum)	max. 10 [m/s] / max. 50 [m/s]
Material - permitted temperature °C	igumid G / -40° to +120° C
Flammability class, igumid G	VDE 0304 IIC UL94 HB

Technical Data



Details of material properties
 ► page 1.38



E2 micro
 Inner height: 14,3 mm

Phone +49- (0) 22 03-96 49-800
 Fax +49- (0) 22 03-96 49-222



► page 5.9

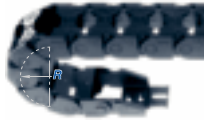
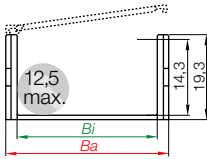

Series B09 snap-open along inner radius

Part No.	Bi [mm]	Ba [mm]	R [mm]	Bending Radii			Weight [kg/m]
B09.16.	16	24,2	028	038	048	≈ 0,24	
B09.20.	20	28,2	028	038	048	≈ 0,25	
B09.30.	30	38,2	028	038	048	≈ 0,28	
B09.40.	40	48,2	028	038	048	≈ 0,31	

Supplement part no. with required radius (R) Example: B09.20. .0

0 = standard color, other colors ▶ page 1.39 · Pitch = 20 mm/link - Links/m = 50

Part No. structure

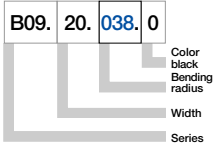



Polymer - pivoting

- One-piece mounting bracket
- Corrosion-resistant
- Available preassembled
- Inner and outer attachment possible
- Available with or without integrated strain relief tiwrap plates

Moving end with bore
(outer link) 080...1(PZ)

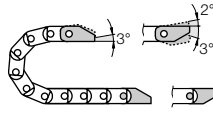

080...2(PZ) Fixed end
with pin (inner link)



Possible installation conditions for assembled mounting brackets ▶ Order example "preassembled" below

080...1(PZ)
Moving end

080...2(PZ)
Fixed end

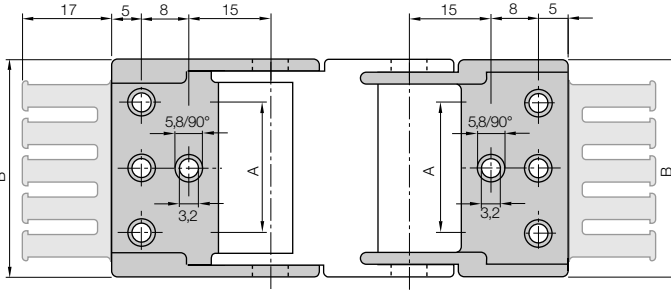

080.16.12 - 080.20.12: center bores only
080.30.12 - 080.40.12: bores (see figure above)

For E-chain®	Part No. full set with tiwrap plate	Part No. full set without tiwrap plate	Number of teeth	Dim. A [mm]	Dim. B [mm]
B09.16. ▶	080.16. 12 PZ	080.16. 12	2	-	24,2
B09.20. ▶	080.20. 12 PZ	080.20. 12	2	-	28,2
B09.30. ▶	080.30. 12 PZ	080.30. 12	3	22	38,2
B09.40. ▶	080.40. 12 PZ	080.40. 12	4	32	48,2

For the preassembled mode please add the index **A1** ... **A4** Example: 080.16. 12 PZ **A1**

Dimensions and order configurations

Strain relief is possible on the moving end and/or the fixed end.

Part No. structure

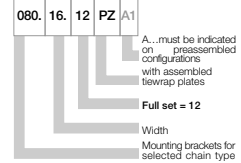

Full set, for both ends:
080. 16. 12 PZ +tiwrap plate
Single-part order:
080. 16. 1 PZ +tiwrap plate
Mounting bracket **with bore**
080. 16. 2 PZ +tiwrap plate
Mounting bracket **with pin**



Quicksnap - the complete, detachable mounting unit, available upon request



Quickfix - mounting bracket with dowel, available upon request

Additional Features

Phone +49- (0) 22 03-96 49-800
Fax +49- (0) 22 03-96 49-222







E2 mini

E2 mini - small and medium sizes

E2 mini are small one-piece or two-piece E-Chains® ideal for high dynamic applications. igus® also offers a host of accessories and fixation options. "Upgrades" to openable versions are available for many types in these cases they are interchangeable and can also serve as replacement.

Typical industries and applications

- Construction machinery
- Handlings
- Furniture
- Packaging machines
- Textile machines
- Vehicle construction
- Woodworking machines
- Glass machines
- Automation
- General machinery



Special equipment: Electrically conductive
ESD/ATEX version upon request



Cleanroom Class 1 (ISO class 3) for Series 10 and 14,
tested by the Dryden Engineering Company, California



UL94 - V2 classifications -
Series 14

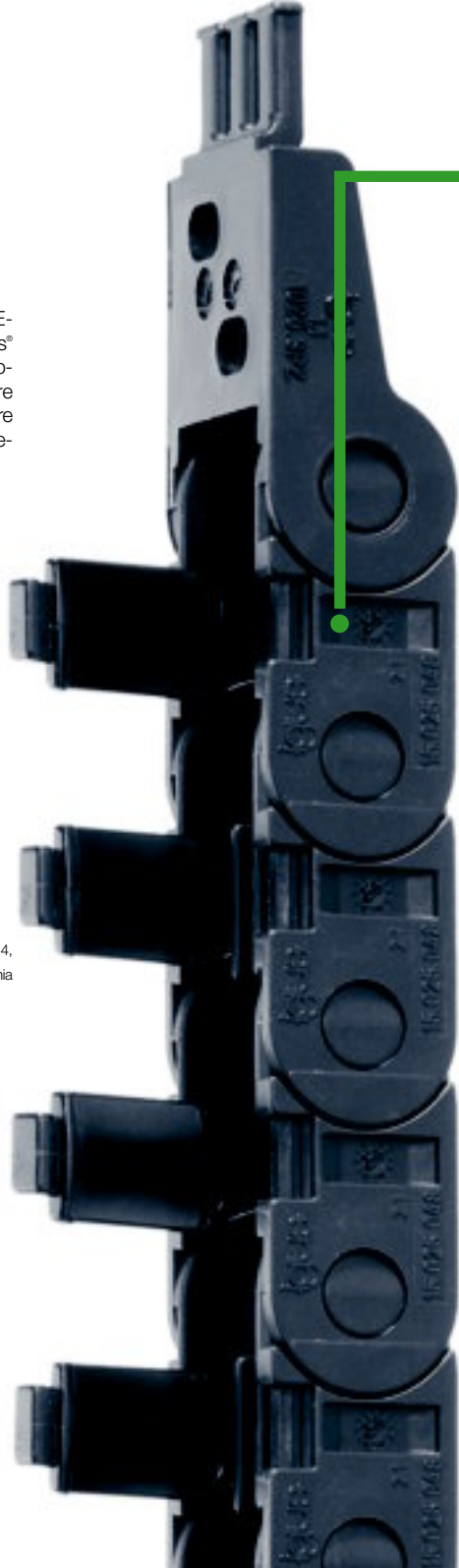



E2 mini E-Chain®, RBR-version with the reverse bending radius



E2 mini E-Chain® in a tooling machine, coolant resistant



Long-travel applications up to 40 m are possible - here: Series 10 in textile machine

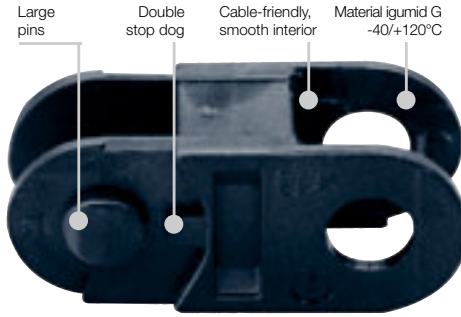

E2 mini one- and two-piece E-Chains* - small and medium sizes

- Small pitch for smooth running
- High torsional rigity
- Double stop dog and large pins for long service life
- Optimized relation: weight - stability
- Large pins for long unsupported lengths
- Easy to assemble
- Various interior separation
- You can find more technical data about the material, chemical resistance, temperatures ► **chapter design, from page 1.38**

Selection table

Series	Inner height <i>hi</i> [mm]	Inner width <i>Bi</i> [mm]	Outer width <i>Ba</i> [mm]	Outer height <i>ha</i> [mm]	Bending radius <i>R</i> [mm]	Unsupported length max. [m]	Page
10	18	15 - 100	26 - 113	23	28 - 180	1,20	5.48
11.031	23	31	41,2	28	45 - 70	≈1,35	5.54
11.080	28	80	93	33,4	38	1,50	5.58
11.1 / 11.2	41	15 - 25	25,5 - 35,5	46	40 - 100	≈1,35	5.62
14	20	15 - 50	26 - 61	25	28 - 125	0,65	5.66
B15i / B15	17	15 - 100	26 - 113	23	38 - 180	1,20	5.70
B17 / B17i	32	15 - 100	25,5 - 113	39	48 - 125	1,00	5.76
F17	32	15	26	39	48	1,20	5.82

Assembling | E2 mini

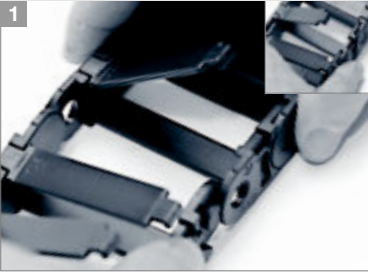

1 Push, click and snap in pin

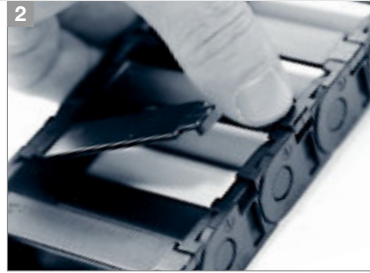

2 Push and snap crossbars

Separating | E2 mini

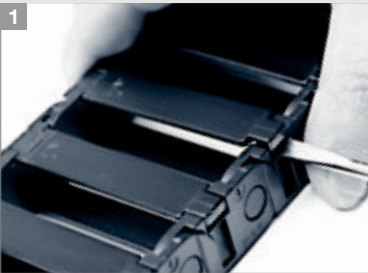

1 Lever crossbars open



2 Swivel crossbars



3 Release side-link



4 Twist and pull apart



E2 mini | Series 10



Price index



Cleanroom Class 1 (ISO class 3)
for Series 10, tested by the Dryden
Engineering Company, California



Special equipment:
Electrically conductive ESD/ATEX
version upon request

- ❶ Large pins and double stop dog for superior life and long unsupported length
- ❷ Mounting bracket with integrated strain relief
- ❸ Dirt-repellent exterior
- ❹ Interior separation available
- ❺ One piece each link
- ❻ Easy to fill configuration
- ⬢ Series E14 Easy Chain®, page 3.32
- ⚡ Snap-open configuration
- ⬢ Series 15 Zipper page, 4.18
- ⬢ Series R15 Zipper Tube, page 4.36
- ❽ Molded-in separator available
Series 10.050.075.S



Easy to assemble and to disassemble



When to use the Series 10:

- If opening is not necessary
- If a small but very stable chain is required



When not to use it:

- If extremely quick opening of the links is necessary
 - ▶ Series 15 Zipper, page 4.18
- If quick insertion of cables with preassembled connectors is required
 - ▶ Series E14 Easy Chain®, page 3.32

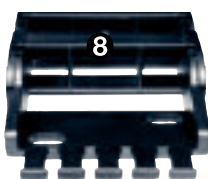

Order example complete E-Chain®

Please indicate chain-lengths or number of links Example: 1 m or 33 links

1 m 10.025.038.0



E-Chain®

with 2 separators 111 assembled every 2nd link

Interior separation

1 set 1025.12PZ



Mounting bracket



Unsupported length

FL_G = with straight upper run

FL_B = with permitted sag

Further information ► **Design, page 1.12**

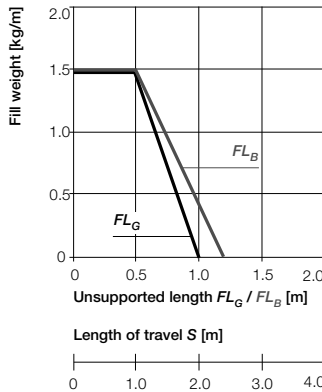
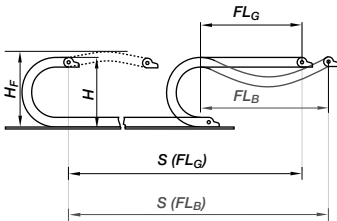

- S = Length of travel
- R = Bending radius
- H = Nominal clearance height
- H_F = Required clearance height
- D = Overlength E-Chain® radius in final position
- $K = \pi \cdot R + \text{"safety"}$

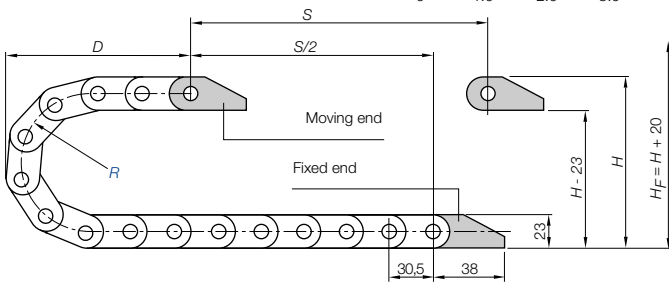

Short travels - unsupported

Unsupported E-Chains® feature positive camber over short travels. This must be accounted for when specifying the clearance height H_F . Please consult igus® if space is particularly restricted.

Pitch = 30,5 mm/link Links/m = 33 (1.006,5 mm) Chain length = $S/2 + K$

R	028	038	048	075	100	110	125	145	180
H	80	100	120	175	225	245	275	315	385
D	70	80	90	120	145	155	170	190	225
K	150	185	215	300	375	410	455	520	630

The required clearance height:
 $H_F = H + 20$ mm
 (with 1,5 kg/m fill weight)

Speed / acceleration FL_G	max. 20 [m/s] / max. 200 [m/s ²]
Speed / acceleration FL_B	max. 3 [m/s] / max. 6 [m/s ²]
Gliding speed / acceleration (maximum)	max. 3 [m/s] / max. 10 [m/s ²]
Material - permitted temperature °C	igumid G / -40° up to +120° C
Flammability class, igumid G	VDE 0304 IIC UL94 HB

Technical Data



Details of material properties
 ► page 1.38



E2 mini
 Inner height: 18 mm

Phone +49- (0) 22 03-96 49-800
 Fax +49- (0) 22 03-96 49-222



► page 5.47

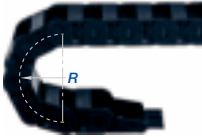
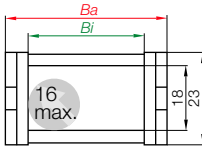

Series 10 E-Chain® - non snap-open

Part No.	Bi [mm]	Ba [mm]	R [mm]	Bending radii								Weight [kg/m]	
10.015.	.0	15	26	028	038	048	075	100	110	125	145	180	≈ 0,35
10.025.	.0	25	36	028	038	048	075	100	110	125	145	180	≈ 0,40
10.038.	.0	38	49	028	038	048	075	100	110	125	145	180	≈ 0,46
10.050.	.0	50	61	028	038	048	075	100	110	125	145	180	≈ 0,52
10.5.	.0	63	76	028	038	048	075	100	110	125	145	180	≈ 0,63
10.6.	.0	80	94	028	038	048	075	100	110	125	145	180	≈ 0,70
10.7.	.0	100	113	028	038	048	075	100	110	125	145	180	≈ 0,76

Supplement Part No. with required radius. Example: 10.025.038.0

0 = standard color, other colors ► page 1.39 · Pitch = 30,5 mm/link - Links/m = 33

Part No. structure

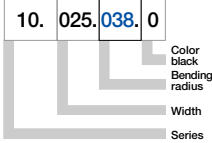

E2 mini | Series 10 | Accessories | Interior Separation

Vertical Separator

unassembled	101
assembled	111



Option 1: Vertical Separators

Vertical Separators are used if a vertical subdivision of the E-Chain® interior is required -

By standard Vertical Separators are assembled every other E-Chain® link

- Standard subdivision with Vertical Separator 111

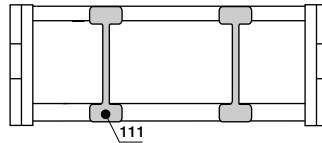

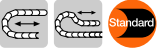

The Standard - option polymer - pivoting

- Recommended for unsupported and gliding applications
- Well suited for tight installation conditions
- Strain relief for detachable tiwrap plates
- Variable traverse angle for flexible assembly
- The twistability of the E-Chain® and the option to assemble the mounting brackets on the fixed end and/or the moving end, enable various installation options

Moving end with bore
(outer link) 10...3P(Z)

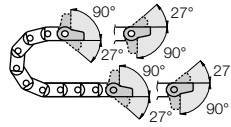

10...4P(Z) Fixed end
with pin (inner link)

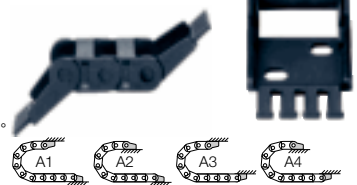

Possible installation conditions for assembled mounting brackets ▶ Order example "preassembled" below

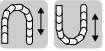

Option polymer - locking

- Recommended for unsupported and gliding applications
- Furthermore:
- At very high speed and/or acceleration
 - If space is limited for height (the H_F measurement)
 - The twistability of the E-Chain® and the option to assemble the mounting brackets on the fixed end and/or the moving end, enable various installation options

Moving end with bore
(outer link) 10...1P(Z)

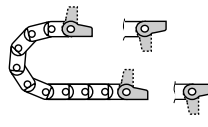

10...2P(Z) Fixed end
with pin (inner link)



Possible installation conditions for assembled mounting brackets ▶ Order example "preassembled" below

10...3P(Z) Standard! (pivoting)
10...1P(Z) (locking)

Standard! (pivoting) 10...4P(Z)
(locking) 10...2P(Z)

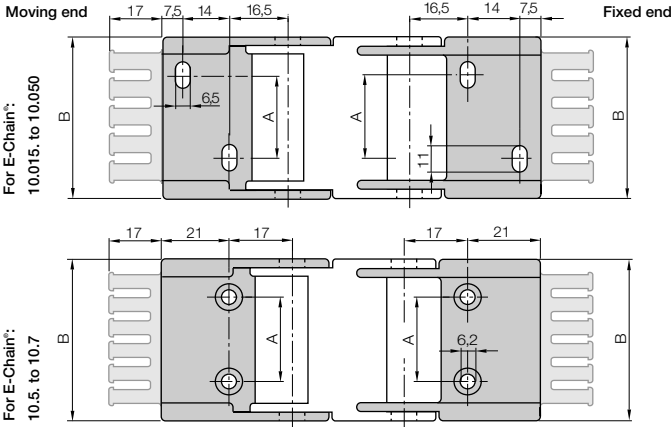

For E-Chain®	Part No. full set with tiwrap plate	Part No. full set without tiwrap plate	Dim. A [mm]	Dim. B [mm]
10.015. ▶	1015. <input type="checkbox"/> PZ	1015. <input type="checkbox"/> P	-	25,5
10.025. ▶	1025. <input type="checkbox"/> PZ	1025. <input type="checkbox"/> P	10	35,5
10.038. ▶	1038. <input type="checkbox"/> PZ	1038. <input type="checkbox"/> P	23	48,5
10.050. ▶	1050. <input type="checkbox"/> PZ	1050. <input type="checkbox"/> P	35	60,5
10.5. ▶	105. <input type="checkbox"/> PZ	105. <input type="checkbox"/> P	48	75,0
10.6. ▶	106. <input type="checkbox"/> PZ	106. <input type="checkbox"/> P	65	92,0
10.7. ▶	107. <input type="checkbox"/> PZ	107. <input type="checkbox"/> P	85	112,0

Please add the Part No. with the requested index - 34 for the pivoting configuration

e.g. 1025. 34 PZ or 12 for the locking configuration e.g. 1025. 12 PZ

For the preassembled mode please add the index A1 ... A4 e.g. 1025. 34 PZ A1

Dimensions and order configurations

Strain relief is possible on the moving end and/or the fixed end.

Part No. structure (pivoting)

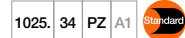

- A₁... must be indicated on preassembled configurations
- Full set with strain relief
- Full set pivoting = 34
- Mounting brackets for selected chain type

Full set, for both ends:

1025. 34 PZ +tiwrap plate

Single-part order:

1025. 3 PZ +tiwrap plate

Mounting bracket with bore

1025. 4 PZ +tiwrap plate

Mounting bracket with pin

Part No. structure (locking)



- A₁... must be indicated on preassembled configurations
- Full set with strain relief
- Full set locking = 12
- Mounting brackets for selected chain type

Full set, for both ends:

1025. 12 PZ +tiwrap plate

Single-part order:

1025. 1 PZ +tiwrap plate

Mounting bracket with bore

1025. 2 PZ +tiwrap plate

Mounting bracket with pin

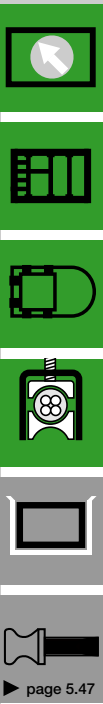

- B_a = Outer width E-Chains* / E-Tube
 B_i = Inner width E-Chains* / E-Tube
 h_a = Outer height E-Chains* / E-Tube
 H_{Ri} = Inner trough height
 H_{Ra} = Outer trough height
 B_{Ri} = Inner trough width ► depends on dim. B_a
 B_{Ra} = Outer trough width
 n_{Mon} = Number of installation sets (left/right)
 n_{Ri} = Number of troughs sets (left/right)
- $H_{Ri} \geq 2 \cdot h_a$
 $B_{Ri} \geq B_a + 4$
- = Guide trough set ● = Glide bar
● = Installation set "Basic" ● = C-profile

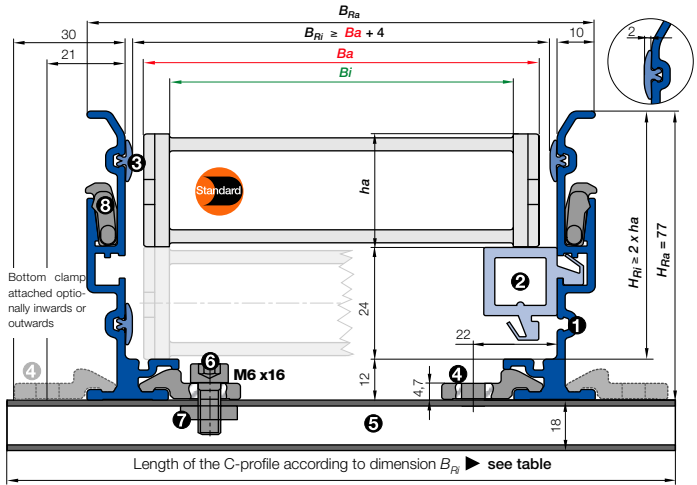

- **Components, trough "Basic":** ① Trough side parts, aluminum, 2 m ② Glide bar, plastic, 2 m ③ Glide strips, plastic, 2 m (without glide strips on request)
- **Components, installation set "Basic":** ④ Bottom clamp, aluminum ⑤ C-profile, steel galvanized ⑥ Screw M6 x 16 ⑦ Sliding nut M6 ⑧ Interface connector, plastic

Installation set "Basic" with C-profile

Bottom Clamp attached optionally inwards or outwards

10.5.038.0 ► Order example

	B_{Ri} [mm]	Part No. attached	
		inwards	outwards
.015	30	-	960.30.125
.025	40	-	960.30.150
.038	53	-	960.30.150
.050	65	960.30.125	960.30.175
.5	80	960.30.125	960.30.175
.6	98	960.30.150	960.30.200
.7	117	960.30.175	960.30.225



Order example: Length of travel 30 m - Center mounted for Series 10.5.038.0 with $B_{Ri} = 80$

Guide trough set (set of 2 trough side parts, incl. glide strips) **without** glide bar

Order text: 16 m guide trough without glide bar (8 x 2 m sections) **Part No. 970.30.SL**

Guide trough set (set of 2 trough side parts, incl. glide strips) **with** glide bar

Order text: 16 m guide trough with glide bar (8 x 2 m sections) **Part No. 970.31.SL**

Installation set "Basic" complete (guide trough-sets + 1)

Order text: 17 installation sets "Basic" **Part No. 960.30.125**

Module for the fixed end

Order text: 1 set **Part No. 970.80**

Option: For an additional noise dampening with

silencer profile, please add Index A - Example: **Part No. 970.30.SLA**

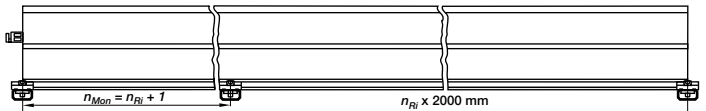

Principle sketch: Number of installation sets to be installed = **Number of trough sections + 1**



A quick fix for mounting the stationary end of an E-Chain*

With this module for the fixed end, fast and easy mounting onto the Aluminum "SuperTrough" is now possible without any drilling. Fast mounting of the E-Chain* by clamping onto the aluminum trough

- Quick relocation of the stationary end
- No drilling necessary

Phone +49- (0) 22 03-96 49-800
Fax +49- (0) 22 03-96 49-222

igus® GmbH
51147 Cologne

Internet: www.igus.eu
E-mail: info@igus.de

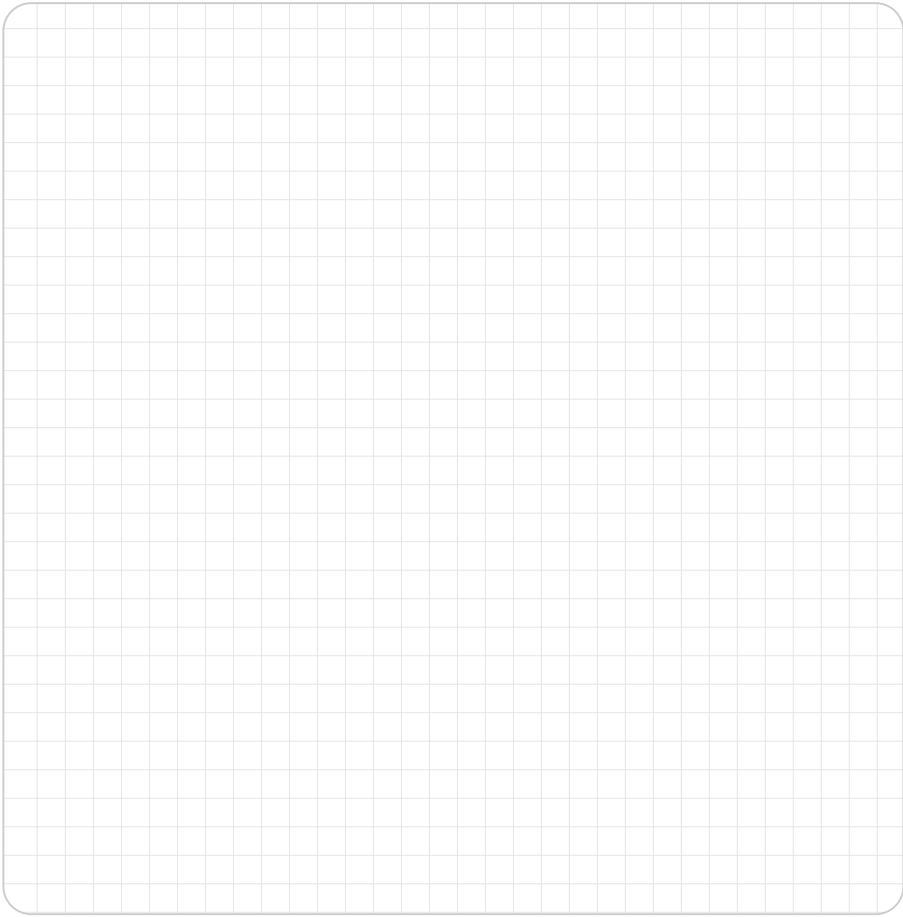

E2 mini
Inner height: 18 mm

Phone +49- (0) 22 03-96 49-800
Fax +49- (0) 22 03-96 49-222



▶ chapter 9



▶ page 5.47



E2 mini E-Chain® as
RBR-version with
double bending radii



Price index



UL94-V2 classifications
upon request

- ① Torsional stability
- ② Mounting bracket with strain relief
- ③ Dirt-repellent exterior
- ④ One piece each link



Easy to assemble and to disassemble



When to use the Series 11.031:

- If space is restricted
- If many cables are arranged vertically adjacent



When not to use it:

- If snap-open links are required
 - ▶ similar width/height from Series Zipper, chapter 4
- If quick insertion of cables with preassembled connectors is required
 - ▶ similar width/height from Series Easy Chain®, chapter 3

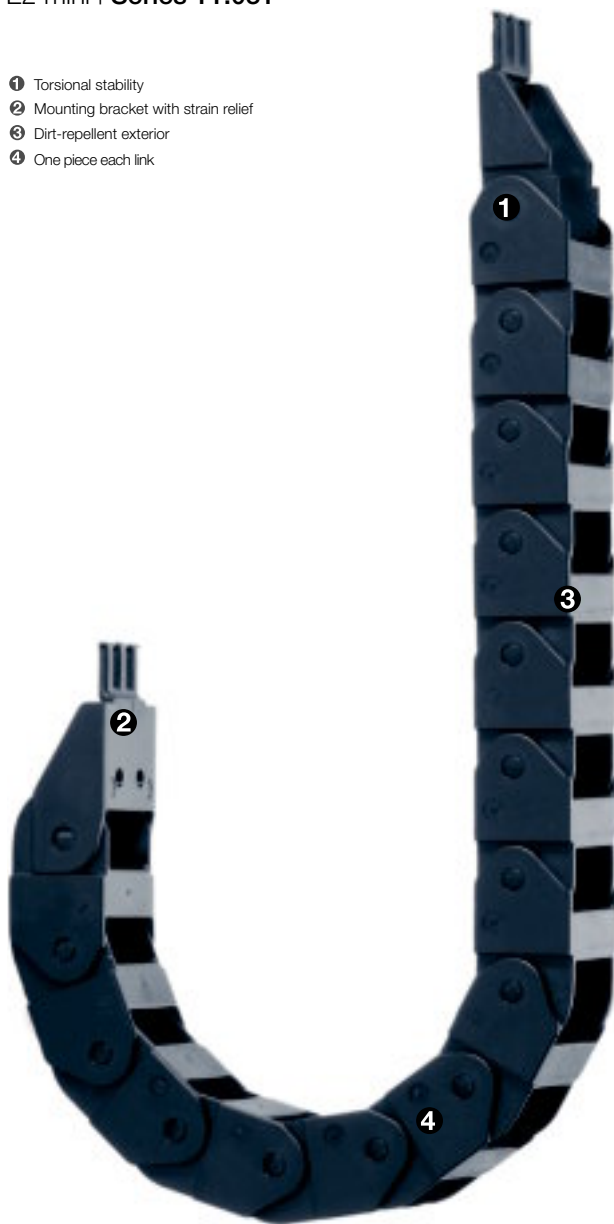

Order example complete E-Chain®

Please indicate chain-lengths or number of links **Example: 1 m or 33 links**

1 m 11.031.070.0



E-Chain®

1 set 11.031.12PZ



Mounting bracket



Unsupported length

FL_G = with straight upper run

FL_B = with permitted sag

Further information ► Design, page 1.12

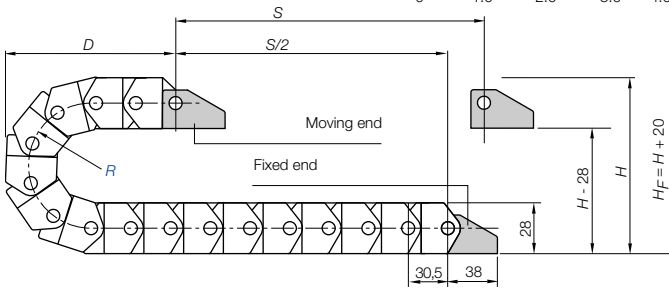
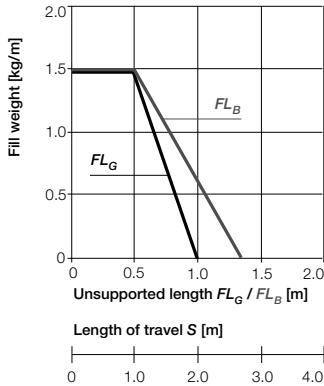
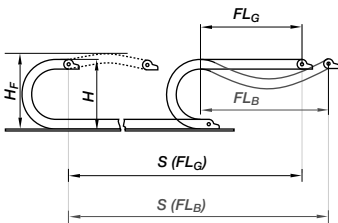

Pitch = 30,5 mm/link Links/m = 33 (1.006,5 mm) Chain length = $S/2 + K$

R	045	070
H	115	165
D	90	115
K	205	285

- S** = Length of travel
- R** = Bending radius
- H** = Nominal clearance height
- H_F** = Required clearance height
- D** = Overlength E-Chain® radius in final position
- K** = $\pi \cdot R$ + "safety"



Short travels - unsupported

Unsupported E-Chains® feature positive camber over short travels. This must be accounted for when specifying the clearance height H_F . Please consult igus® if space is particularly restricted.

The required clearance height:
 $H_F = H + 20$ mm
 (with 0,5 kg/m fill weight)

23

E2 mini
Inner height: 23 mm

Phone +49- (0) 22 03-96 49-800
Fax +49- (0) 22 03-96 49-222



► page 5.47

Speed / acceleration FL_G	max. 20 [m/s] / max. 200 [m/s ²]
Speed / acceleration FL_B	max. 3 [m/s] / max. 6 [m/s ²]
Gliding speed / acceleration (maximum)	max. 3 [m/s] / max. 10 [m/s ²]
Material - permitted temperature °C	igumid G / -40° up to +120° C
Flammability class, igumid G	VDE 0304 IIC UL94 HB

Technical Data



Details of material properties
 ► page 1.38

igus® E-ChainSystems®

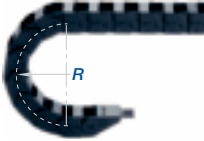
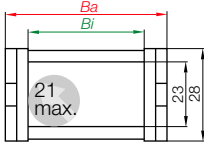

Series 11.031 E-Chain® - non snap-open

Part No.	Bi [mm]	Ba [mm]	R [mm]	Bending radii	Weight [kg/m]
11.031. <input type="text"/> .0	31	41,2	<input type="text"/> 045 <input type="text"/> 070		~ 0,43

Supplement Part No. with required radius. Example: 11.031.070.0

0 = standard color, other colors ▶ page 1.39 · Pitch = 30,5 mm/link - Links/m = 33

Phone +49- (0) 22 03-96 49-800
 Fax +49- (0) 22 03-96 49-222

Part No. structure

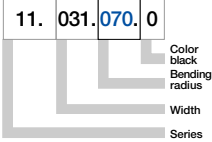

igus® GmbH
 51147 Cologne

Internet: www.igus.eu
 E-mail: info@igus.de



Polymer, one-piece

- One-piece mounting bracket
- Corrosion-resistant
- Available preassembled
- Inner and outer attachment possible
- Available with or without strain relief tiewrap plates

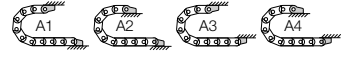
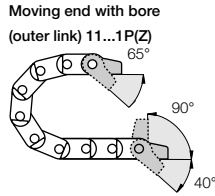

11...2P(Z) Fixed end
with pin (inner link)

Possible installation conditions for assembled mounting brackets ▶ Order example "preassembled" below

11...1P(Z)
Moving end

11...2P(Z)
Fixed end

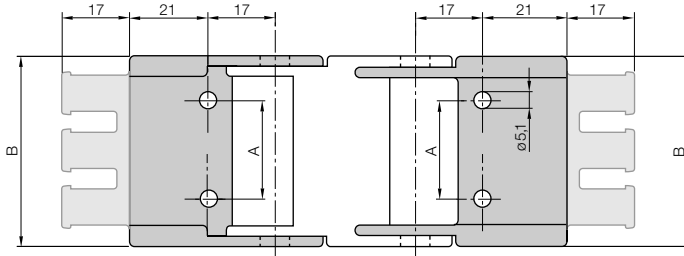

Dimensions and order configurations

Strain relief is possible on the moving end and/or the fixed end.

Part No. structure

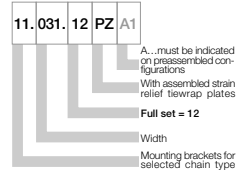

Full set, for both ends:

11.031.12 PZ +tiewrap plate

Single-part order:

11.031.1 PZ +tiewrap plate

Mounting bracket **with bore**

11.031.2 PZ +tiewrap plate

Mounting bracket **with pin**

For E-Chain*	Part No. full set with tiewrap plate	Part No. full set without tiewrap plate	Dim. A [mm]	Dim. B [mm]
11.031. ▶	11.031.12 PZ	11.031.12 P	16	42

For the **preassembled** mode please add the index **A1 ... A4** e.g. 11.031.12 PZ **A1**

Phone +49- (0) 22 03-96 49-800
Fax +49- (0) 22 03-96 49-222



● ● ● Price index



UL94-V2 classifications
upon request

- ① Version with larger pins and double stop dog for long service life and long unsupported length
- ② Mounting bracket with strain relief
- ③ Dirt-repellent exterior
- ④ One piece each link
- ⑤ Stable design



Easy to assemble and to disassemble



When to use the Series 11.080:

- If space is restricted
- If many cables are arranged vertically adjacent



When not to use it:

- If snap-open links are required
 - ▶ similar width/height from Series Zipper, chapter 4
- If quick insertion of cables with preassembled connectors is required
 - ▶ similar width/height from Series Easy Chain®, chapter 3

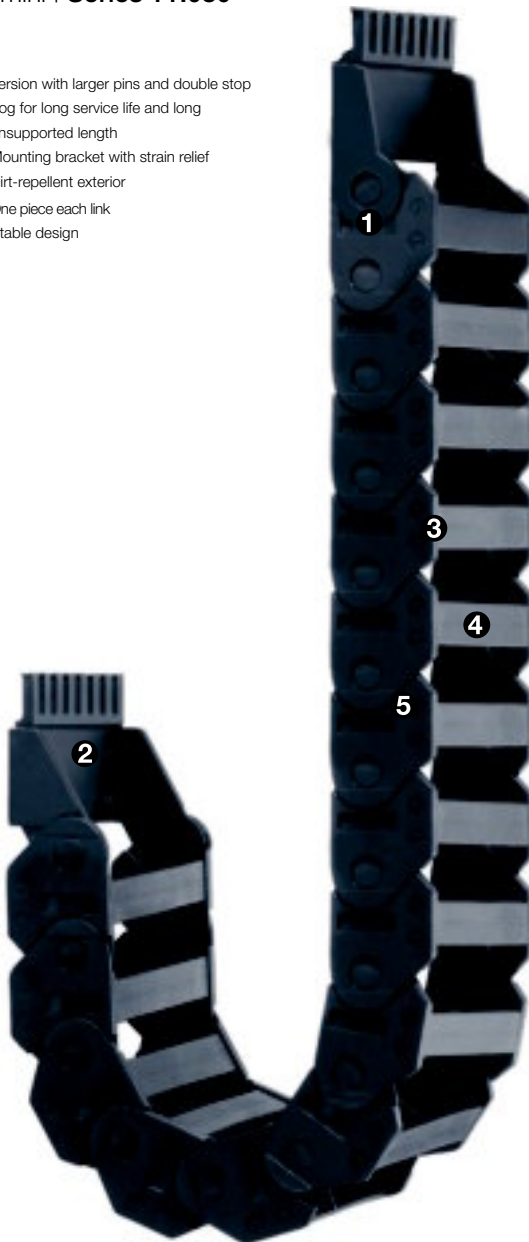

Order example complete E-Chain®

Please indicate chain-lengths or number of links **Example: 1 m or 33 links**

1 m 11.080.038.0



E-Chain®

1 set 11.080.12PZ



Mounting bracket



Unsupported length

FL_G = with straight upper run
 FL_B = with permitted sag
 Further information ► Design, page 1.12

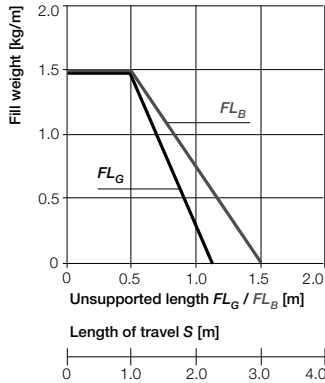
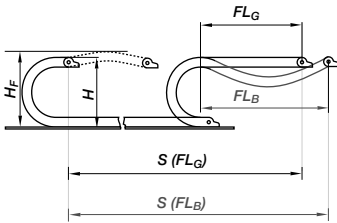

- S = Length of travel
- R = Bending radius
- H = Nominal clearance height
- H_F = Required clearance height
- D = Overlength E-Chain® radius in final position
- $K = \pi \cdot R + \text{"safety"}$

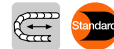
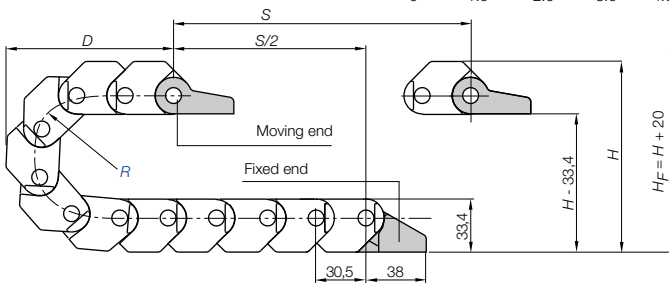

Short travels - unsupported

Unsupported E-Chains® feature positive camber over short travels. This must be accounted for when specifying the clearance height H_F . Please consult igus® if space is particularly restricted.

Pitch = 30,5 mm/link Links/m = 33 (1.006,5 mm) Chain length = $S/2 + K$

R	038
H	110
D	90
K	185

The required clearance height:
 $H_F = H + 20$ mm
 (with 0,5 kg/m fill weight)

28

E2 mini
 Inner height: 28mm

Phone +49- (0) 22 03-96 49-800
 Fax +49- (0) 22 03-96 49-222



► page 5.47

Speed / acceleration FL_G	max. 20 [m/s] / max. 200 [m/s ²]
Speed / acceleration FL_B	max. 3 [m/s] / max. 6 [m/s ²]
Gliding speed / acceleration (maximum)	max. 3 [m/s] / max. 10 [m/s ²]
Material - permitted temperature °C	igumid G / -40° up to +120° C
Flammability class, igumid G	VDE 0304 IIC UL94 HB

Technical Data



Details of material properties
 ► page 1.38

igus® E-ChainSystems®

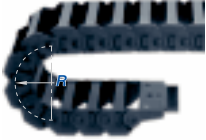
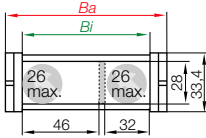

Series 11.080 E-Chain® - non snap-open

Part No.	Bi [mm]	Ba [mm]	R [mm]	Bending radii	Weight [kg/m]
11.080. <input type="text" value="0"/> .0	80	93	<input type="text" value="038"/>		- 0,73

Supplement Part No. with required radius. Example: 11.080. .0
 0 = standard color, other colors ▶ page 1.39 · Pitch = 30,5 mm/link - Links/m = 33

Part No. structure

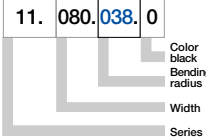

Phone +49- (0) 22 03-96 49-800
 Fax +49- (0) 22 03-96 49-222

igus® GmbH
 51147 Cologne

Internet: www.igus.eu
 E-mail: info@igus.de



Polymer, one-piece

- One-piece mounting bracket
- Corrosion-resistant
- Available preassembled
- Inner and outer attachment possible
- Available with or without strain relief tiewrap plates

Moving end with bore
(outer link) 11...1P(Z)

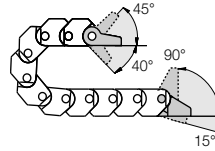

11...2P(Z) Fixed end
with pin (inner link)



Possible installation conditions for assembled mounting brackets ▶ Order example "preassembled" below

11...1P(Z)

Moving end

11...2P(Z)

Fixed end

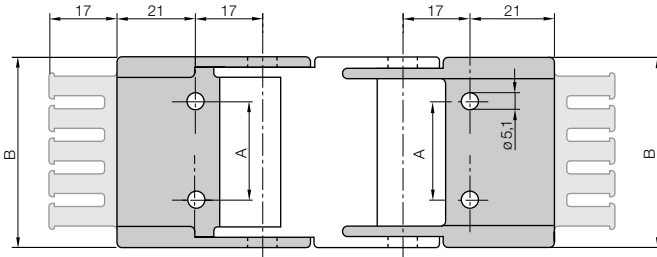

Dimensions and order configurations

Strain relief is possible on the moving end and/or the fixed end.

Part No. structure

11.080.12.PZ.A2

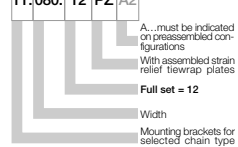

Full set, for both ends:

11.080.12.PZ +tiewrap plate

Single-part order:

11.080.1.PZ +tiewrap plate

Mounting bracket **with bore**

11.080.2.PZ +tiewrap plate

Mounting bracket **with pin**

For E-chain*	Part No. full set with tiewrap plate	Part No. full set without tiewrap plate	Dim. A [mm]	Dim. B [mm]
11.080. ▶	11.080.12.PZ	11.080.12.P	65	93

For the **preassembled** mode please add the index **A2** e.g. 11.080.12.PZ.A2

Phone +49- (0) 22 03-96 49-800
Fax +49- (0) 22 03-96 49-222





Price index

UL94-V2 classifications
upon request

- ① Enlarged inner height
- ② Mounting bracket with strain relief
- ③ Dirt-repellent exterior
- ④ One piece each link



Easy to assemble and to disassemble



When to use the Series 11.1 / 11.2:

- If space is restricted
- If many cables are arranged vertically adjacent



When not to use it:

- If snap-open links are required
 - ▶ similar width/height from Series Zipper, chapter 4
- If quick insertion of cables with preassembled connectors is required
 - ▶ similar width/height from Series Easy Chain®, chapter 3



Order example complete E-Chain®

Please indicate chain-lengths or number of links **Example: 1 m or 33 links**

1 m 11.2.100.0



E-Chain®

1 set 102.12PZ



Mounting bracket



Unsupported length

FL_G = with straight upper run

FL_B = with permitted sag

Further information ► Design, page 1.12

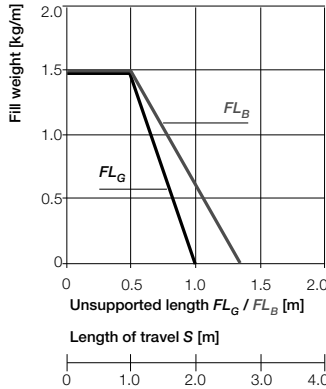
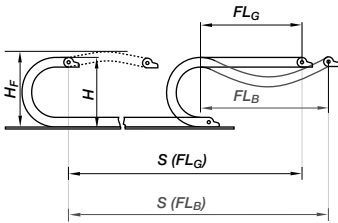

- S = Length of travel
- R = Bending radius
- H = Nominal clearance height
- H_F = Required clearance height
- D = Overlength E-Chain® radius in final position
- $K = \pi \cdot R + \text{"safety"}$

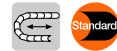
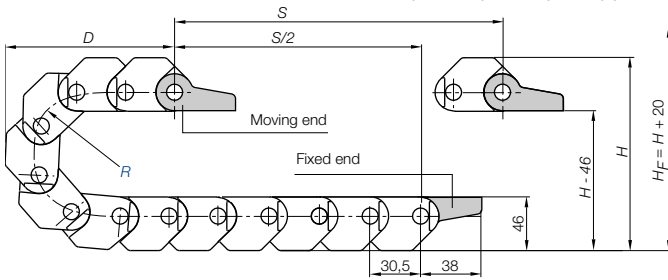

Short travels - unsupported

Unsupported E-Chains® feature positive camber over short travels. This must be accounted for when specifying the clearance height H_F . Please consult igus® if space is particularly restricted.

Pitch = 30,5 mm/link Links/m = 33 (1.006,5 mm) Chain length = $S/2 + K$

R	040	063	075	100
H	149	195	219	269
D	105	128	140	165
K	212	275	305	395

The required clearance height:
 $H_F = H + 20$ mm
(with 0,5 kg/m fill weight)

41

E2 mini
Inner height: 41 mm

Phone +49- (0) 22 03-96 49-800
Fax +49- (0) 22 03-96 49-222



► page 5.47

Speed / acceleration FL_G	max. 20 [m/s] / max. 200 [m/s]
Speed / acceleration FL_B	max. 3 [m/s] / max. 6 [m/s]
Gliding speed / acceleration (maximum)	max. 3 [m/s] / max. 10 [m/s]
Material - permitted temperature °C	igumid G / -40° up to +120° C
Flammability class, igumid G	VDE 0304 IIC UL94 HB

Technical Data



Details of material properties
► page 1.38

igus® E-ChainSystems®

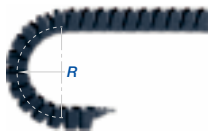
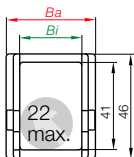

Series 11.1/11.2 E-Chain® - non snap-open

Part No.	Bl [mm]	Ba [mm]	R [mm]	Bending radii	Weight [kg/m]
11.1. <input type="text"/> .0	15	25,5	<input type="text"/> 040	<input type="text"/> 063 <input type="text"/> 075 <input type="text"/> 100	≈ 0,50
11.2. <input type="text"/> .0	25	35,5	<input type="text"/> 040	<input type="text"/> 063 <input type="text"/> 075 <input type="text"/> 100	≈ 0,53

Supplement Part No. with required radius. Example: 11.2. 100.0

0 = standard color, other colors ► page 1.39 · Pitch = 30,5 mm/link - Links/m = 33

Part No. structure

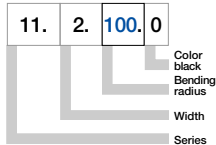

Phone +49- (0) 22 03-96 49-800
Fax +49- (0) 22 03-96 49-222

igus® GmbH
51147 Cologne

Internet: www.igus.eu
E-mail: info@igus.de



Polymer, one-piece

- One-piece mounting bracket
- Corrosion-resistant
- Available preassembled
- Inner and outer attachment possible
- Available with or without strain relief tiwrap plates

Moving end with bore
(outer link) 10...1P(Z)

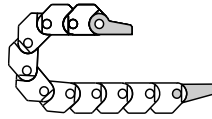

10...2P(Z) Fixed end
with pin (inner link)

Possible installation condition for assembled mounting brackets ▶ Order example "preassembled" below

10...1P(Z)
Moving end

10...2P(Z)
Fixed end

Dimensions and order configurations

Strain relief is possible on the moving end and/or the fixed end.

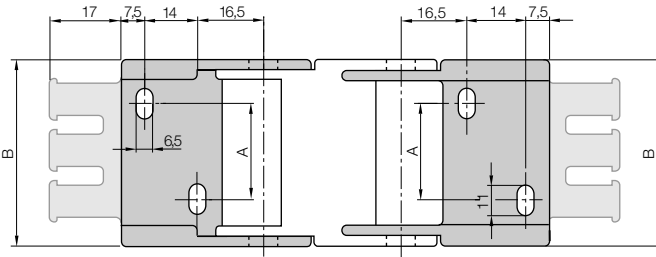

Part No. structure

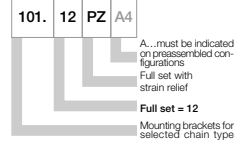

Full set, for both ends:

101.12PZ +tiwrap plate

Single-part order:

101.1PZ +tiwrap plate

Mounting bracket with bore

101.2PZ +tiwrap plate

Mounting bracket with pin

For E-Chain*	Part No. full set with tiwrap plate	Part No. full set without tiwrap plate	Dim. A [mm]	Dim. B [mm]
11.1 ▶	101.12PZ	101.12P	-	26
11.2 ▶	102.12PZ	102.12P	10	36

For the preassembled mode please add the index A4 e.g. 101.12PZA4

Also available:

Option: Steel, one-piece

- One-piece mounting bracket
- Available pre-assembled

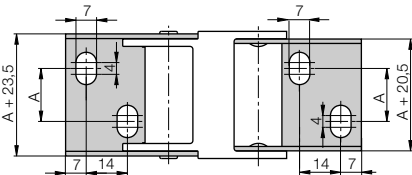

For E-Chain*	Part No. one-piece	Part No. set two-piece	Dim. A* [mm]	Dim. B* [mm]
11.1 ▶	101.12	100.12	-	3
11.2 ▶	102.12	100.12	10	13

*A may be equal to B owing to slot

Option: Steel, two-piece

- 1 set, suitable for all widths
- Inner and outer attachment possible

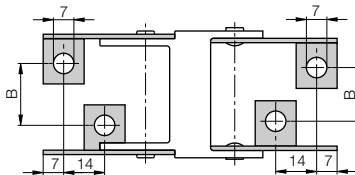

Phone +49- (0) 22 03-96 49-800
Fax +49- (0) 22 03-96 49-222



▶ page 5.47



Price index



Cleanroom Class 1 (ISO class 3)
for Series 14, tested by the Dryden
Engineering Company, California



Special equipment:
Electrically conductive ESD/ATEX
version upon request



UL94-V2 classifications



Easy to assemble and to disassemble



When to use the Series 14:

- For applications with low loads
- Fast installation of the cables



When not to use it:

- For gliding applications
▶ Series 15 Zipper, page 4.18
- For long unsupported lengths
▶ Series 15 Zipper, page 4.18

- 1 Snap-open along inner radius with film-hinge
- 2 Flammability class UL V2
- 3 Mounting bracket with strain relief
- 4 Dirt-repellent exterior
- 5 For gliding applications
▶ Series 15 Zipper, page 4.18
- 6 For longer unsupported lengths
▶ Series 15 Zipper, page 4.18



Order example complete E-Chain®

Please indicate chain-lengths or number of links Example: 1 m or 33 links

1 m 14.2.038.0



E-Chain®

1 set 114.2.12PZ



Mounting bracket



Unsupported length

FL_G = with straight upper run

FL_B = with permitted sag

Further information ► **Design, page 1.12**

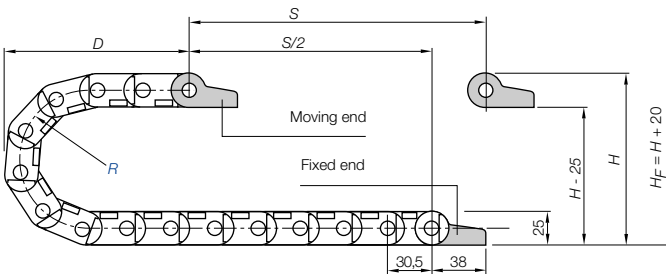
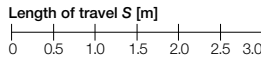
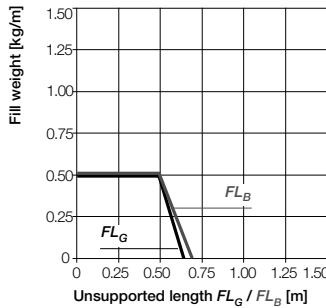
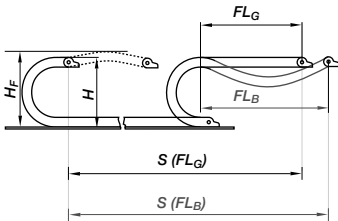

Short travels - unsupported

Unsupported E-Chains® feature positive camber over short travels. This must be accounted for when specifying the clearance height H_F . Please consult igus® if space is particularly restricted.

Pitch = 30,5 mm/link Links/m = 33 (1.006,5 mm) Chain length = $S/2 + K$

R	028	038	048	075	100	125
H	82	102	122	177	227	277
D	71	81	91	120	145	170
K	150	185	215	300	375	455

The required clearance height:
 $H_F = H + 20$ mm
 (with 0,5 kg/m fill weight)



E2 mini
Inner height: 20 mm

Phone +49- (0) 22 03-96 49-800
Fax +49- (0) 22 03-96 49-222



Technical Data

Speed / acceleration FL_G	max. 20 [m/s] / max. 200 [m/s ²]
Speed / acceleration FL_B	max. 3 [m/s] / max. 6 [m/s ²]
Gliding speed / acceleration (maximum)	max. 3 [m/s] / max. 10 [m/s ²]
Material - permitted temperature °C	igumid G / -40° up to +120° C
Flammability class, igumid NB	VDE 0304 IIC UL94 V2



Details of material properties
 ► page 1.38



► page 5.47

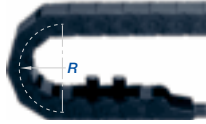
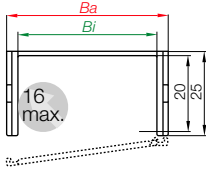

Series 14 E-Chain® - snap-open along inner radius

Part No.	Bi [mm]	Ba [mm]	R [mm]	Bending radii						Weight [kg/m]
14.1. <input type="text"/> .0	15	26	<input type="text"/> 028	<input type="text"/> 038	<input type="text"/> 048	<input type="text"/> 075	<input type="text"/> 100	<input type="text"/> 125	≈ 0,31	
14.2. <input type="text"/> .0	25	36	<input type="text"/> 028	<input type="text"/> 038	<input type="text"/> 048	<input type="text"/> 075	<input type="text"/> 100	<input type="text"/> 125	≈ 0,32	
14.3. <input type="text"/> .0	38	49	<input type="text"/> 028	<input type="text"/> 038	<input type="text"/> 048	<input type="text"/> 075	<input type="text"/> 100	<input type="text"/> 125	≈ 0,40	
14.4. <input type="text"/> .0	50	61	<input type="text"/> 028	<input type="text"/> 038	<input type="text"/> 048	<input type="text"/> 075	<input type="text"/> 100	<input type="text"/> 125	≈ 0,41	

Supplement Part No. with required radius. Example: 14.2. 038 0

0 = standard color, other colors ▶ page 1.39 · Pitch = 30,5 mm/link - Links/m = 33

Part No. structure

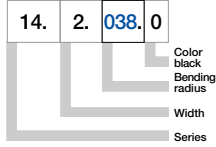

Phone +49- (0) 22 03-96 49-800
 Fax +49- (0) 22 03-96 49-222

igus® GmbH
 51147 Cologne

Internet: www.igus.eu
 E-mail: info@igus.de



Option Polymer, one-piece

- One-piece mounting bracket
- Corrosion-resistant
- Available preassembled
- Inner and outer attachment possible
- Available with or without strain relief tiewrap plates

Moving end with bore (outer link) 114...1P(Z)

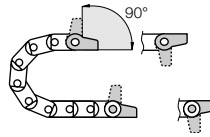

114...2P(Z) Fixed end with pin (inner link)



Possible installation conditions for assembled mounting brackets ▶ Order example "preassembled" below

114...1P(Z)
Moving end

114...2P(Z)
Fixed end

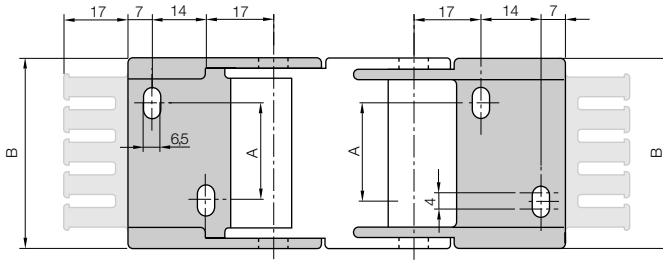

Dimensions and order configurations

Strain relief is possible on the moving end and/or the fixed end.

Part No. structure

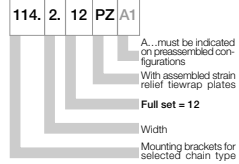

Full set, for both ends:

114.2.12PZ +tiewrap plate

Single-part order:

114.2.1PZ +tiewrap plate

Mounting bracket with bore

114.2.2PZ +tiewrap plate

Mounting bracket with pin

For E-Chain®	Part No. full set with tiewrap plate	Part No. full set without tiewrap plate	Dim. A [mm]	Dim. B [mm]
14.1. ▶	114.1.12PZ	114.1.12P	-	26,3
14.2. ▶	114.2.12PZ	114.2.12P	10	36,3
14.3. ▶	114.3.12PZ	114.3.12P	23	49,3
14.4. ▶	114.4.12PZ	114.4.12P	35	61,3

For the preassembled mode please add the index A1 ... A4 e.g. 114.2.12PZA1



Quicksnap - the complete, detachable mounting unit, upon request



Quickfix - mounting bracket with dowel, upon request

Additional Features



▶ page 5.47

Phone +49- (0) 22 03-96 49-800
Fax +49- (0) 22 03-96 49-222

● ● ● Price index



Special equipment:
Electrically conductive ESD/ATEX
version upon request



UL94-V2 classifications
upon request

- ① Large pins and double stop dog for long service life and long unsupported length
- ② To be opened along outer radius (Series B15) and/or along inner radius (Series B15i), these Series can be combined
- ③ Mounting bracket with integrated strain relief
- ④ Dirt-repellent exterior
- ⑤ Interior separation available



Easy to assemble and to disassemble



When to use the Series B15i/B15:

- If opening is necessary
- If a small but very stable chain is required



When not to use it:

- If opening of the links is not necessary
 - ▶ Series 10 E2 mini, page 5.48
- If torsion occurs
 - ▶ Series E14 Easy Chain®, page 3.32

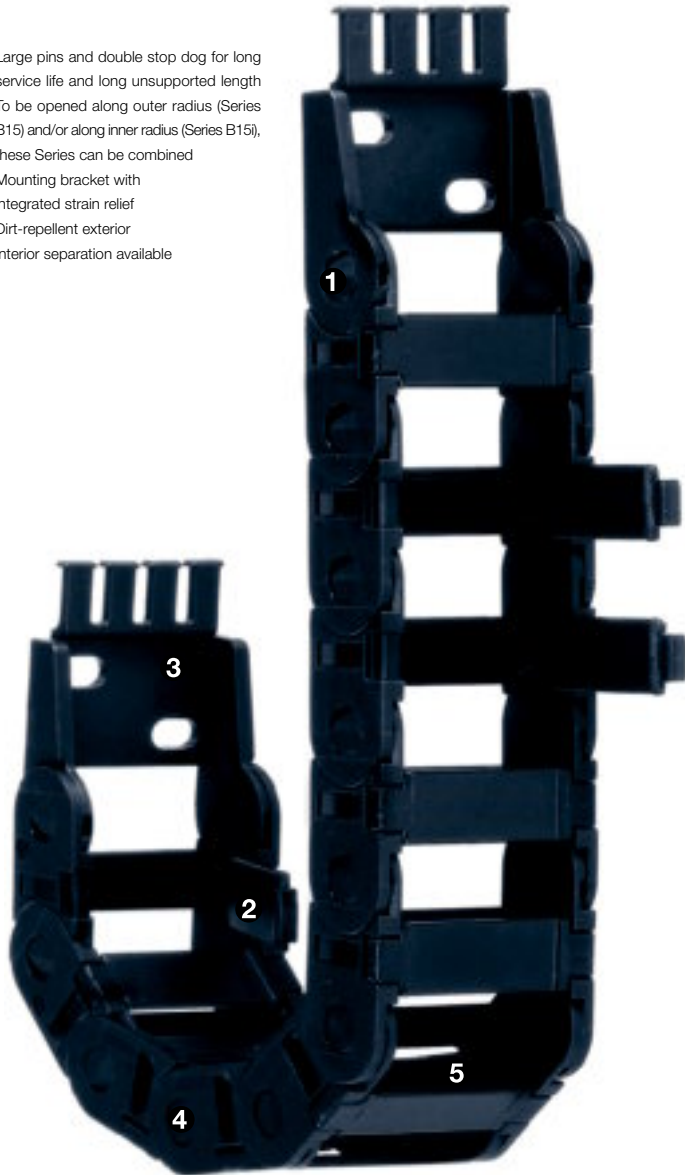

Order example complete E-Chain®

Please indicate chain-lengths or number of links **Example: 1 m or 33 links**

1 m **B15.025.038.0**



E-Chain®

with 2 separators **154** assembled every 2nd link



Interior separation

1 set **1025.12PZ**



Mounting bracket



Unsupported length

FL_G = with straight upper run

FL_B = with permitted sag

Further information ► Design, page 1.12

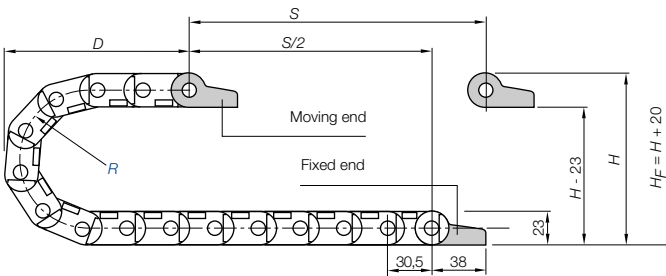
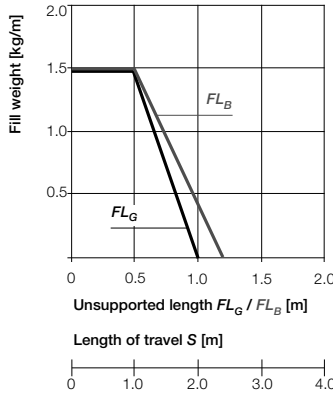
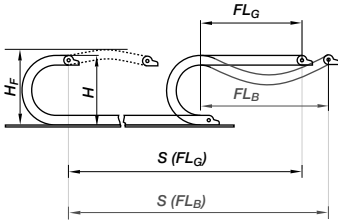

- S = Length of travel
- R = Bending radius
- H = Nominal clearance height
- H_F = Required clearance height
- D = Overlength E-Chain® radius in final position
- $K = \pi \cdot R + \text{"safety"}$

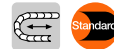

Short travels - unsupported

Unsupported E-Chains® feature positive camber over short travels. This must be accounted for when specifying the clearance height H_F . Please consult igus® if space is particularly restricted.

Pitch = 30,5 mm/link Links/m = 33 (1.006,5 mm) Chain length = $S/2 + K$

R	038	048	075	100	110	125	145	180
H	100	120	175	225	245	275	315	385
D	80	90	120	145	155	170	190	225
K	185	215	300	375	410	455	520	630

The required clearance height:
 $H_F = H + 20$ mm
(with 0,5 kg/m fill weight)



E2 mini
Inner height: 17 mm

Phone +49- (0) 22 03-96 49-800
Fax +49- (0) 22 03-96 49-222



► page 5.47

Technical Data

Speed / acceleration FL_G	max. 20 [m/s] / max. 200 [m/s ²]
Speed / acceleration FL_B	max. 3 [m/s] / max. 6 [m/s ²]
Gliding speed / acceleration (maximum)	max. 3 [m/s] / max. 10 [m/s ²]
Material - permitted temperature °C	igumid G / -40° up to +120° C
Flammability class, igumid G	VDE 0304 IIC UL94 HB



Details of material properties
► page 1.38

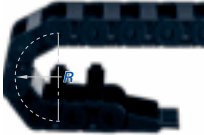
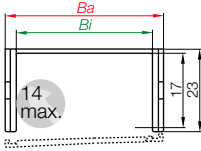

Series B15i E-Chain® - snap-open along inner radius

Part No.	Bi [mm]	Ba [mm]	R [mm]	Bending radii								Weight [kg/m]
B15i.015. □.0	15	26	038	048	075	100	110	125	145	180	= 0,35	
B15i.025. □.0	25	36	038	048	075	100	110	125	145	180	= 0,40	
B15i.038. □.0	38	49	038	048	075	100	110	125	145	180	= 0,46	
B15i.050. □.0	50	61	038	048	075	100	110	125	145	180	= 0,52	
B15i.5. □.0	63	76	038	048	075	100	110	125	145	180	= 0,63	
B15i.6. □.0	80	94	038	048	075	100	110	125	145	180	= 0,70	
B15i.7. □.0	100	113	038	048	075	100	110	125	145	180	= 0,76	

Supplement Part No. with required radius. Example: B15i.025. 038.0

0 = standard color, other colors ▶ page 1.39 - Pitch = 30,5 mm/link - Links/m = 33

Part No. structure

B15i. 025. 038. 0

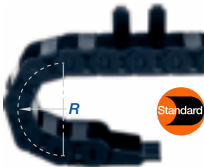
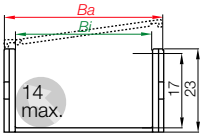

Series B15 - snap-open along outer radius - Standard!

Part No.	Bi [mm]	Ba [mm]	R [mm]	Bending radii								Weight [kg/m]
B15.015. □.0	15	26	038	048	075	100	110	125	145	180	= 0,35	
B15.025. □.0	25	36	038	048	075	100	110	125	145	180	= 0,40	
B15.038. □.0	38	49	038	048	075	100	110	125	145	180	= 0,46	
B15.050. □.0	50	61	038	048	075	100	110	125	145	180	= 0,52	
B15.5. □.0	63	76	038	048	075	100	110	125	145	180	= 0,63	
B15.6. □.0	80	94	038	048	075	100	110	125	145	180	= 0,70	
B15.7. □.0	100	113	038	048	075	100	110	125	145	180	= 0,76	

Supplement Part No. with required radius. Example: B15.025. 038.0

0 = standard color, other colors ▶ page 1.39 - Pitch = 30,5 mm/link - Links/m = 33

Part No. structure

B15. 025. 038. 0



Option 1: Vertical Separators

Vertical Separators are used if a vertical subdivision of the E-Chain® interior is required -

By standard Vertical Separators are assembled every other E-Chain® link

- Standard subdivision with Vertical Separator, slotted 154,

for combinations with Full-Width Shelf 111.X

Vert. Separator, slotted		
unassembled	153	1.5 8
assembled	154	

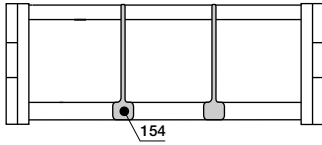

E2 mini
Inner height: 17 mm

Option 2: Full-Width Shelves

For applications involving many thin cables with similar or identical diameters

- Side Plate 156 can be combined with Vertical Separator, slotted 154 and Full-Width Shelf 111.X

Side Plate		
unassembled	155	1.5 4.75
assembled	156	

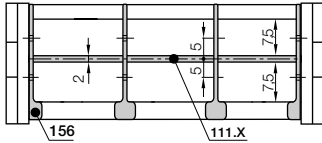

Phone +49- (0) 22 03-96 49-800
Fax +49- (0) 22 03-96 49-222

Width X [mm]	Part No. unassembled	Part No. assembled
015	110.15	111.15
025	110.25	111.25
038	110.38	111.38
050	110.50	111.50

Width X [mm]	Part No. unassembled	Part No. assembled
063	110.63	111.63
080	110.80	111.80
100	110.100	111.100

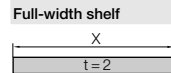

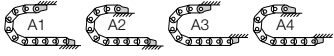

Possible installation conditions for assembled mounting brackets ▶ Order example "preassembled" below

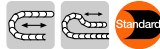

The Standard - option polymer - pivoting

- Recommended for unsupported and gliding applications
- Well suited for tight installation conditions
- Strain relief with detachable tiwrap plates
- Variable traverse angle for flexible assembly

Moving end with bore
(outer link) 10...3P(Z)

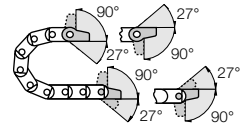

10...4P(Z) Fixed end
with pin (inner link)

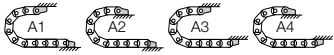

Possible installation conditions for assembled mounting brackets ▶ Order example "preassembled" below

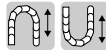

Option polymer - locking

- Recommended for unsupported and gliding applications
- At very high speed and/or acceleration
- If space is limited for height (the H_F measurement)

Furthermore:

Moving end with bore
(outer link) 10...1P(Z)

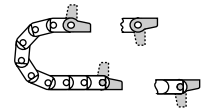

10...2P(Z) Fixed end
with pin (inner link)

Dimensions and order configurations

Strain relief is possible on the moving end and/or the fixed end.

Part No. structure (pivoting)



A... must be indicated on preassembled configurations
Full set with strain relief
Full set pivoting = 34
Mounting brackets for selected chain type

Full set, for both ends:

1025. 34 PZ +tiwrap plate

Single-part order:

1025. 3 PZ +tiwrap plate

Mounting bracket with bore

1025. 4 PZ +tiwrap plate

Mounting bracket with pin

Part No. structure (locking)

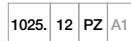

A... must be indicated on preassembled configurations
Full set with strain relief
Full set locking = 12
Mounting brackets for selected chain type

Full set, for both ends:

1025. 12 PZ +tiwrap plate

Single-part order:

1025. 1 PZ +tiwrap plate

Mounting bracket with bore

1025. 2 PZ +tiwrap plate

Mounting bracket with pin

10...3P(Z) Standard! (pivoting)

10...1P(Z) (locking)

Moving end

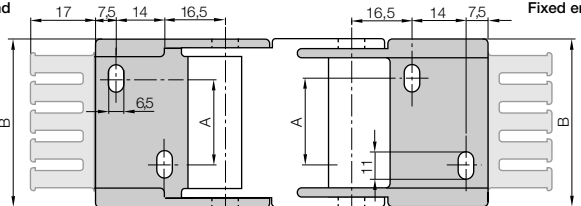

Standard! (pivoting) 10...4P(Z)

(locking) 10...2P(Z)

Fixed end

For E-Chain®:
B15i·B15.015 bis
B15i·B15.050

For E-Chain®:
B15i·B15.5 to
B15i·B15.7

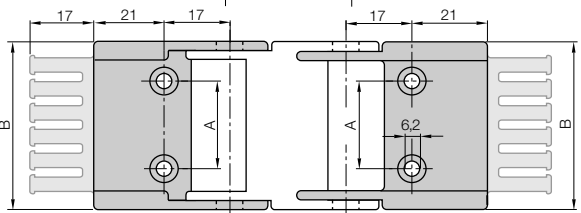

For E-Chain®	Part No. full set with tiwrap plate	Part No. full set without tiwrap plate	Dim. A [mm]	Dim. B [mm]
B15i·B15.015. ▶	1015. <input type="checkbox"/> PZ	1015. <input type="checkbox"/> P	-	25,5
B15i·B15.025. ▶	1025. <input type="checkbox"/> PZ	1025. <input type="checkbox"/> P	10	35,5
B15i·B15.038. ▶	1038. <input type="checkbox"/> PZ	1038. <input type="checkbox"/> P	23	48,5
B15i·B15.050. ▶	1050. <input type="checkbox"/> PZ	1050. <input type="checkbox"/> P	35	60,5
B15i·B15.5. ▶	105. <input type="checkbox"/> PZ	105. <input type="checkbox"/> P	48	75,0
B15i·B15.6. ▶	106. <input type="checkbox"/> PZ	106. <input type="checkbox"/> P	65	92,0
B15i·B15.7. ▶	107. <input type="checkbox"/> PZ	107. <input type="checkbox"/> P	85	112,0

Please add the Part No. with the requested index - 34 for the pivoting configuration

e.g. 1025. 34 PZ or 12 for the locking configuration e.g. 1025. 12 PZ

For the preassembled mode please add the index A1...A4 e.g. 1025. 34 PZ A1

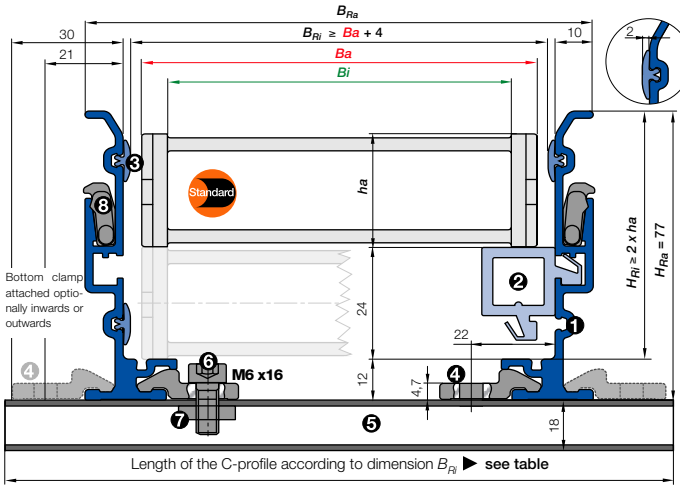

- B_a = Outer width E-Chains® / E-Tube
- B_i = Inner width E-Chains® / E-Tube
- h_a = Outer height E-Chains® / E-Tube
- H_{Ri} = Inner trough height
- H_{Ra} = Outer trough height
- B_{Ri} = Inner trough width ► depends on dim. B_a
- B_{Ra} = Outer trough width
- n_{Mon} = Number of installation sets (left/right)
- n_{Ri} = Number of troughs sets (left/right)
- $H_{Ri} \geq 2 \cdot h_a$
- $B_{Ri} \geq B_a + 4$
- = Guide trough set ● = Glide bar
- = Installation set "Basic" ● = C-profile

Installation set "Basic" with C-profile

Bottom Clamp attached optionally inwards or outwards

B15.038.038.0 ► Order example

B_{Ri} [mm]	Part No.	
	attached inwards	attached outwards
.015 30	-	960.30.125
.025 40	-	960.30.150
.038 53	-	960.30.150
.050 65	960.30.125	960.30.175
.5 80	960.30.125	960.30.175
.6 98	960.30.150	960.30.200
.7 117	960.30.175	960.30.225



- **Components, trough "Basic":** ① Trough side parts, aluminum, 2 m ② Glide bar, plastic, 2 m ③ Glide strips, plastic, 2 m (without glide strips on request)
- **Components, installation set "Basic":** ④ Bottom clamp, aluminum ⑤ C-profile, steel galvanized ⑥ Screw M6 x16 ⑦ Sliding nut M6 ⑧ Interface connector, plastic

Order example: Length of travel 30 m - Center mounted for Series B15.038.038.0 with $B_{Ri} = 53$

- Guide trough set (set of 2 trough side parts, incl. glide strips) **without** glide bar
Order text: 16 m guide trough without glide bar (8 x 2 m sections) Part No. 970.30.SL
- Guide trough set (set of 2 trough side parts, incl. glide strips) **with** glide bar
Order text: 16 m guide trough with glide bar (8 x 2 m sections) Part No. 970.31.SL
- Installation set "Basic" complete (guide trough-sets + 1)
Order text: 17 installation sets "Basic" Part No. 960.30.150
- Module for the fixed end
Order text: 1 set Part No. 970.80
- Option:** For an additional noise dampening with silencer profile, please add Index A - Example:
Part No. 970.30.SLA

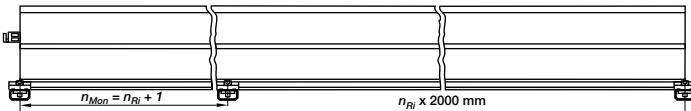

Principle sketch: Number of installation sets to be installed = **Number of trough sections + 1**



A quick fix for mounting the stationary end of an E-Chain®

With this module for the fixed end, fast and easy mounting onto the Aluminum "SuperTrough" is now possible without any drilling. Fast mounting of the E-Chain® by clamping onto the aluminum trough

- Quick relocation of the stationary end
- No drilling necessary





Price index



Special equipment:
Electrically conductive ESD/ATEX
version upon request



UL94-V2 classifications
upon request



Easy to assemble and to disassemble



When to use the Series B17/B17i:

- If opening is necessary
- If a rather small chain with broad inner width is required
- If reverse bending radius is required



When not to use it:

- If quick opening of the links is required
 - ▶ Series 17 Zipper, page 4.24
- If quick insertion of cables with preassembled connectors is required
 - ▶ Series E16 Easy Chain®, page 3.42

- ❶ Snap-open with film-hinge along the outer radius (Series B17) and/or along inner radius (Series B17i), these Series can be combined
- ❷ Small pitch for very quiet operation
- ❸ Mounting bracket with integrated strain relief
- ❹ Dirt-repellent exterior
- ❺ Small E-Chain® with large inner height
- ❻ Interior separation available
- ❼ Quick-opening configuration
 - ▶ Series 17 Zipper, page 4.24
- ❽ Closed, easy to open version
 - ▶ Series R17 Zipper Tube, page 4.42
- ❾ If torsion occurs
 - ▶ Series E16 Easy Chain®, page 3.42



Order example complete E-Chain®

Please indicate chain-lengths or number of links Example: 1 m or 33 links

1 m B17.1.063.0

 E-Chain®
with 2 separators 172 assembled every 2nd link
 Interior separation

1 set 117.1.12PZ

 Mounting bracket

Unsupported length

FL_G = with straight upper run

FL_B = with permitted sag

Further information ► **Design, page 1.12**

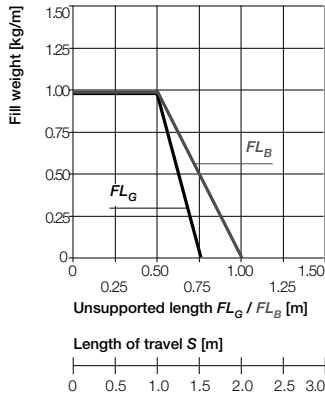
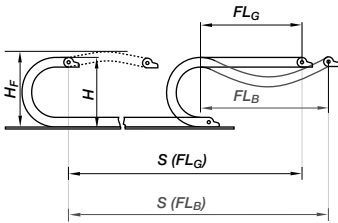

- S = Length of travel
- R = Bending radius
- H = Nominal clearance height
- H_F = Required clearance height
- D = Overlength E-Chain® radius in final position
- $K = \pi \cdot R + \text{"safety"}$

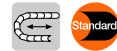
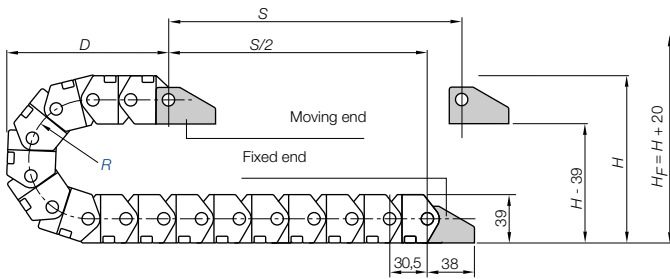

Short travels - unsupported

Unsupported E-Chains® feature positive camber over short travels. This must be accounted for when specifying the clearance height H_F . Please consult igus® if space is particularly restricted.

Pitch = 30,5 mm/link Links/m = 33 (1.006,5 mm) Chain length = $S/2 + K$

R	048*	063	075	100	125
H	135	165	189	239	289
D	100	115	130	155	180
K	220	275	305	395	475

* Radius 048 not for B17.5, B17i.5, B17.7, B17i.7

The required clearance height:
 $H_F = H + 25 \text{ mm}$
(with 1,5 kg/m fill weight)

Speed / acceleration FL_G	max. 20 [m/s] / max. 200 [m/s ²]
Speed / acceleration FL_B	max. 3 [m/s] / max. 6 [m/s ²]
Gliding speed / acceleration (maximum)	max. 3 [m/s] / max. 10 [m/s ²]
Material - permitted temperature °C	igumid G / -40° up to +120° C
Flammability class, igumid G	VDE 0304 IIC UL94 HB

Technical Data



Details of material properties
► page 1.38



E2 mini
Inner height: 32 mm

Phone +49- (0) 22 03-96 49-800
Fax +49- (0) 22 03-96 49-222



► page 5.47

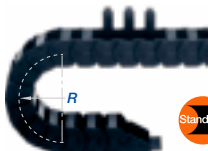
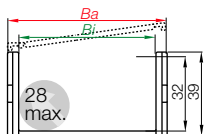

Series B17 - snap-open along outer radius

Part No.	Bi [mm]	Ba [mm]	R [mm]	Bending radii	Weight [kg/m]
B17.1. <input type="text"/> .0	15	25,5	048	063 075 100 125	≈ 0,52
B17.2. <input type="text"/> .0	25	35,5	048	063 075 100 125	≈ 0,59
B17.3. <input type="text"/> .0	38	48,5	048	063 075 100 125	≈ 0,65
B17.4. <input type="text"/> .0	50	60,5	048	063 075 100 125	≈ 0,70
B17.5. <input type="text"/> .0	63	76,0	063	075 100 125	≈ 0,83
B17.6. <input type="text"/> .0	80	93,0	048	063 075 100 125	≈ 0,92
B17.7. <input type="text"/> .0	100	113,0	063	075 100 125	≈ 1,06

Supplement Part No. with required radius. Example: B17.1.063.0

0 = standard color, other colors ▶ page 1.39 - Pitch = 30,5 mm/link - Links/m = 33

Part No. structure

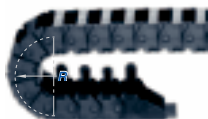
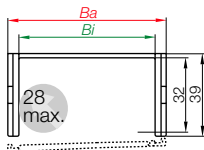
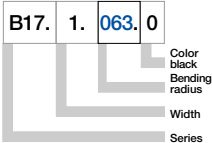

Series B17i - snap-open along inner radius

Part No.	Bi [mm]	Ba [mm]	R [mm]	Bending radii	Weight [kg/m]
B17i.1. <input type="text"/> .0	15	25,5	048	063 075 100 125	≈ 0,52
B17i.2. <input type="text"/> .0	25	35,5	048	063 075 100 125	≈ 0,59
B17i.3. <input type="text"/> .0	38	48,5	048	063 075 100 125	≈ 0,65
B17i.4. <input type="text"/> .0	50	60,5	048	063 075 100 125	≈ 0,70
B17i.5. <input type="text"/> .0	63	76,0	063	075 100 125	≈ 0,83
B17i.6. <input type="text"/> .0	80	93,0	048	063 075 100 125	≈ 0,92
B17i.7. <input type="text"/> .0	100	113,0	063	075 100 125	≈ 1,06

The widths Bi 15/25/50/63/80/100 are available upon request. Time of delivery approx. 6-8 weeks after order.

Supplement Part No. with required radius. Example: B17i.3.063.0

0 = standard color, other colors ▶ page 1.39 - Pitch = 30,5 mm/link - Links/m = 33

Part No. structure

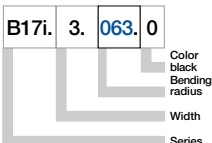

Option 1: Vertical Separators

Vertical Separators are used if a vertical subdivision of the E-Chain® interior is required -

By standard Vertical Separators are assembled every other E-Chain® link

- Standard subdivision with **Vertical Separator, slotted 172B** (for B17.1 to B17.4), or **Vertical Separator, slotted 174B** (for B17.5 to B17.7) for combinations with **Full-Width Shelf 111.X**

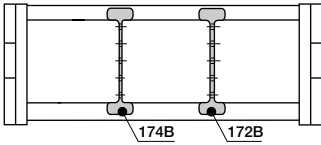

Vert. Separator, slotted for B17.1 to B17.4

unassembled	171B
assembled	172B



Vert. Separator, slotted for B17.5 to B17.7

unassembled	173B
assembled	174B



Option 2: Full-Width Shelves

For applications involving many thin cables with similar or identical diameters

- **Side Plate 156** can be combined with **Vertical Separator, slotted 172B** (for B17.1 to B17.4) or **Vertical Separator, slotted 174B** (for B17.5 to B17.7) and **Full-Width Shelf 111.X**

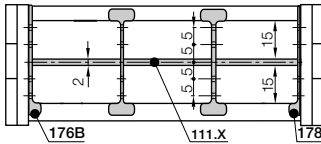

Side Plate for B17.1 to B17.4

unassembled 175B

assembled 176B



Side Plate for B17.5 to B17.7

unassembled 177

assembled 178



Width X [mm]	Part No.	
	unassembled	assembled
015	110.15	111.15
025	110.25	111.25
038	110.38	111.38
050	110.50	111.50

Width X [mm]	Part No.	
	unassembled	assembled
063	110.63	111.63
080	110.80	111.80
100	110.100	111.100

Full-Width Shelf

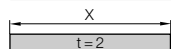

E2 mini
Inner height: 32 mm

Phone +49- (0) 22 03-96 49-800
Fax +49- (0) 22 03-96 49-222

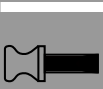

► page 5.47



Possible installation conditions for assembled mounting brackets ▶ Order example "preassembled" below



Polymer, one-piece

- One-piece mounting bracket
- Corrosion-resistant
- Available preassembled
- Inner and outer attachment possible
- Available with or without integrated strain relief tiwrap plates

Moving end with bore
(outer link) 117...1P(Z)

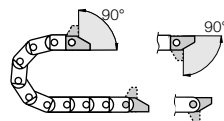

117...2P(Z) Fixed end
with pin (inner link)

Phone +49- (0) 22 03-96 49-800
Fax +49- (0) 22 03-96 49-222

igus® GmbH
51147 Cologne

Internet: www.igus.eu
E-mail: info@igus.de

Dimensions and order configurations

Strain relief is possible on the moving end and/or the fixed end.

117...1P(Z)
Moving end

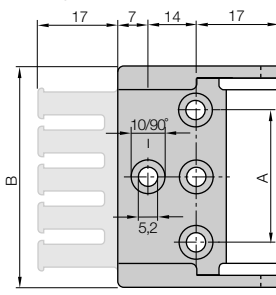

117...2P(Z)
Fixed end

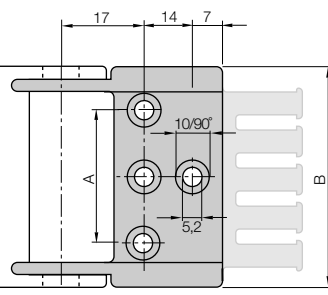

Part No. structure

117. 1. 12 PZ A1

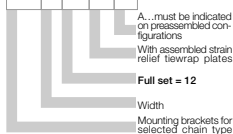

A... must be indicated on preassembled configurations
With assembled strain relief tiwrap plates
Full set = 12
Width
Mounting brackets for selected chain type

Full set, for both ends:

117.1.12PZ + tiwrap plate

Single-part order:

117.1.1PZ + tiwrap plate

Mounting bracket with bore

117.1.2PZ + tiwrap plate

Mounting bracket with pin

117.1.12P(Z): center bores only

117.2.12P(Z) - 117.7.12P(Z): outer bores only

For E-Chain®	Part No. full set with tiwrap plate	Part No. full set without tiwrap plate	Number of teeth	Dim. A [mm]	Dim. B [mm]
B17.1.	▶ 117.1.12PZ	117.1.12P	2	-	25,5
B17.2.	▶ 117.2.12PZ	117.2.12P	3	12	35,5
B17-B17i.3.	▶ 117.3.12PZ	117.3.12P	4	25	48,5
B17.4.	▶ 117.4.12PZ	117.4.12P	5	37	60,5
B17.5.	▶ 117.5.12PZ	117.5.12P	6	48	76,0
B17.6.	▶ 117.6.12PZ	117.6.12P	8	65	93,0
B17.7.	▶ 117.7.12PZ	117.7.12P	10	85	113,0

For the preassembled mode please add the index [A1]...[A4] e.g. 117.1.12PZ[A1]



E2 mini
Inner height: 32 mm

Phone +49- (0) 22 03-96 49-800
Fax +49- (0) 22 03-96 49-222

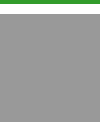

● ● ● Price index



Special equipment:
Electrically conductive ESD/ATEX
version upon request



UL94-V2 classifications
upon request



Easy to assemble and to disassemble



When to use the Series F17:

- For applications with low loads
- If a quick access to cables is required
- For small bending radii with a huge interior height is required
- For fast applications
- If a small E-Chain® with huge interior height is required
- If aesthetic design is required



When not to use it:

- If cable installation without opening lids is possible
 - ▶ Series 11.080 E2 mini, page 5.58
- If extremely quick, zipper-like access to cables is required
 - ▶ Serie R17 Zipper, page 4.42
- For gliding applications
 - ▶ Series 2600/2700/2650/2680 E2/000, page 5.114

- ① Snap-open along inner radius with film-hinge
- ② Small pitch for smooth running
- ③ Mounting bracket with integrated strain relief
- ④ Dirt-repellent exterior
- ⑤ Two-piece, small E-Chain® with great inner height
- ⑥ Small Bending radii
- ⑦ Elegant design
- ⑧ Closed outside

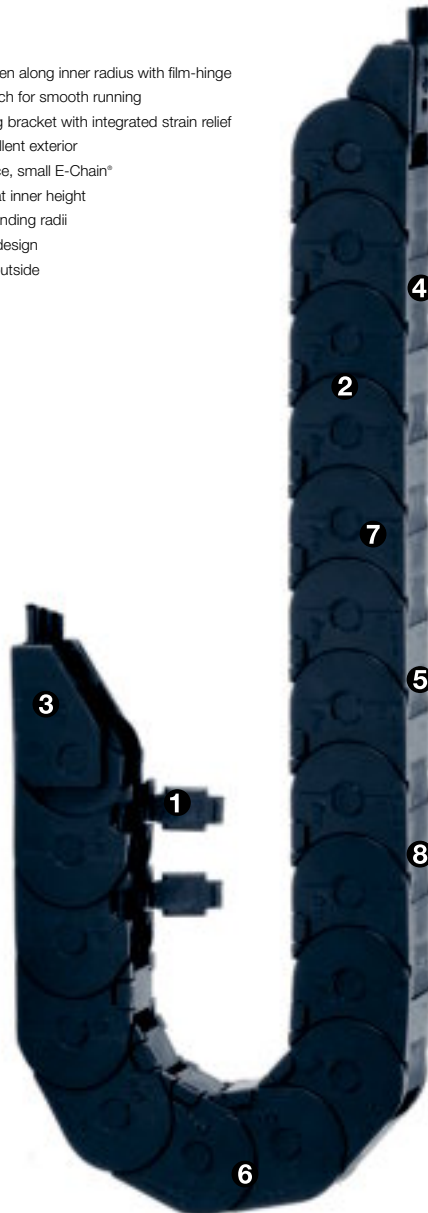

Order example complete E-Tube

Please indicate chain-lengths or number of links **Example: 1 m or 33 links**

1 m F17.025.063.0

E-Chain®

with 2 separators R172 assembled every 2nd link

Interior separation

1 set 117.025.12PZ

Mounting bracket



Unsupported length

FL_G = with straight upper run
 FL_B = with permitted sag
 Further information ► **Design, page 1.12**

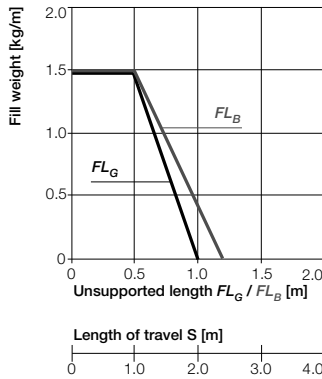
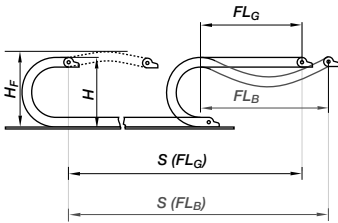

- S = Length of travel
- R = Bending radius
- H = Nominal clearance height
- H_F = Required clearance height
- D = Overlength E-Chain® radius in final position
- $K = \pi \cdot R + \text{"safety"}$

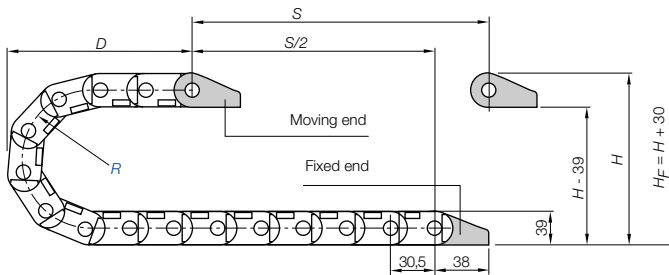

Short travels - unsupported

Unsupported E-Chains® feature positive camber over short travels. This must be accounted for when specifying the clearance height H_F . Please consult igus® if space is particularly restricted.

Pitch = 30,5 mm/link Links/m = 33 (1.006,5 mm) Chain length = $S/2 + K$

R	048
H	135
D	100
K	220

The required clearance height:
 $H_F = H + 30$ mm
 0,5 kg/m fill weight)

Speed / acceleration FL_G	max. 20 [m/s] / max. 200 [m/s ²]
Speed / acceleration FL_B	max. 3 [m/s] / max. 6 [m/s ²]
Gliding speed / acceleration (maximum)	max. 10 [m/s] / max. 50 [m/s ²]
Material - permitted temperature °C	igumid G / -40° to +120° C
Flammability class, igumid G	VDE 0304 IIC UL94 HB

Technical Data



Details of material properties
 ► page 1.38



E2 mini
 Inner height: 32 mm

Phone +49- (0) 22 03-96 49-800
 Fax +49- (0) 22 03-96 49-222



► page 5.47

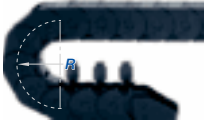
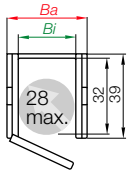

Serie F17 - snap-open along inner radius

Part No.	Bi [mm]	Ba [mm]	R [mm]	Bending Radii	Weight [kg/m]
F17.015.□.0	15	26	048		~ 0,52

The bending radii 063 075 100 125 are available upon request.

Delivery time: approx. 8-10 weeks after receipt of order!

Supplement part no. with required radius (R) Example: F17.015.048.0

0 = standard color, other colors ▶ page 1.39 · Pitch = 30,5 mm/link - Links/m = 33

Part No. structure

F17. 015. 048. 0



Serie F17 - Interior separation

Vert. Separator, slotted	
unassembled	R171
assembled	R172

Option 1: Vertical Separators

Vertical Separators are used if a vertical subdivision of the E-Chain® interior is required -

By standard Vertical Separators are assembled every other E-Chain® link

- Standard subdivision with Vertical Separator, slotted R172, for combinations with Full-Width Shelf 111.X

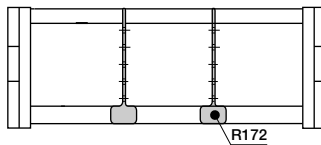

Option 2: Full-Width Shelves

For applications involving many thin cables with similar or identical diameters

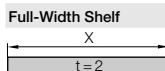
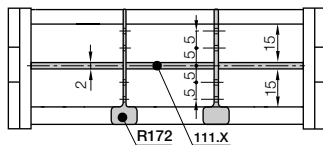

Width X [mm]	Part No. unassembled	Part No. assembled
015	110.15	111.15



Polymer - locking

- One-piece mounting bracket
- Corrosion-resistant
- Available preassembled
- Inner and outer attachment possible
- Available with or without integrated strain relief tiwrap plates

Moving end with bore
(outer link) 117...1P(Z)

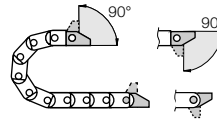

117...2P(Z) Fixed end
with pin (inner link)



Possible installation conditions for assembled mounting brackets ▶ Order example "preassembled" below

117...1P(Z)
Moving end

117...2P(Z)
Fixed end

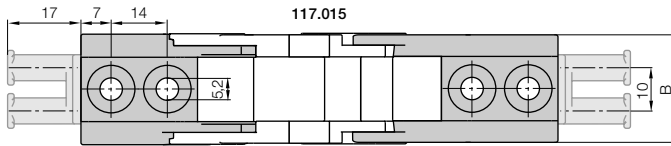

For E-chain*	Part No. full set with tiwrap plate	Part No. full set without tiwrap plate	Number of teeth	Dim. B [mm]
F17.015. ▶	117.015. [12] PZ	117.015. [12] P	2	25,7

For the preassembled mode please add the index [A1] ... [A4] Example: 117.015. [12] PZ [A1]

Dimensions and order configurations

Strain relief is possible on the moving end and/or the fixed end.

Part No. structure

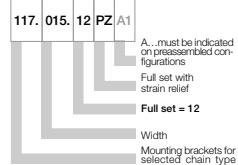

Full set, for both ends:

[117.]015.[12] PZ +tiwrap plate

Single-part order:

[117.]015.[1] PZ +tiwrap plate

Mounting bracket with bore

[117.]015.[2] PZ +tiwrap plate

Mounting bracket with pin

Phone +49- (0) 22 03-96 49-800
Fax +49- (0) 22 03-96 49-222







25000.05

11

E2/000

E2/000 - E-Chains® with 2 part link design for a wide range of applications

E2/000 - the standard

The E2/000 Series is igus® fourth generation in this popular size range. Much past experience went into this Millennium Series: easy and versatile assembly combined with ruggedness - high stability paired with quieter motion - long cable life and many fixation options. The design is consistent within all E2/000 variations. It is the standard product for machine builders around the world.

Typical industries and applications

- Material handling
- Construction machinery
- Woodworking machines
- Glass machines
- Plastic machines
- Long travel applications in many industries
- Semicon
- Theatrical and entertainment and amusement parcs
- Vehicles
- General machinery
- And many more

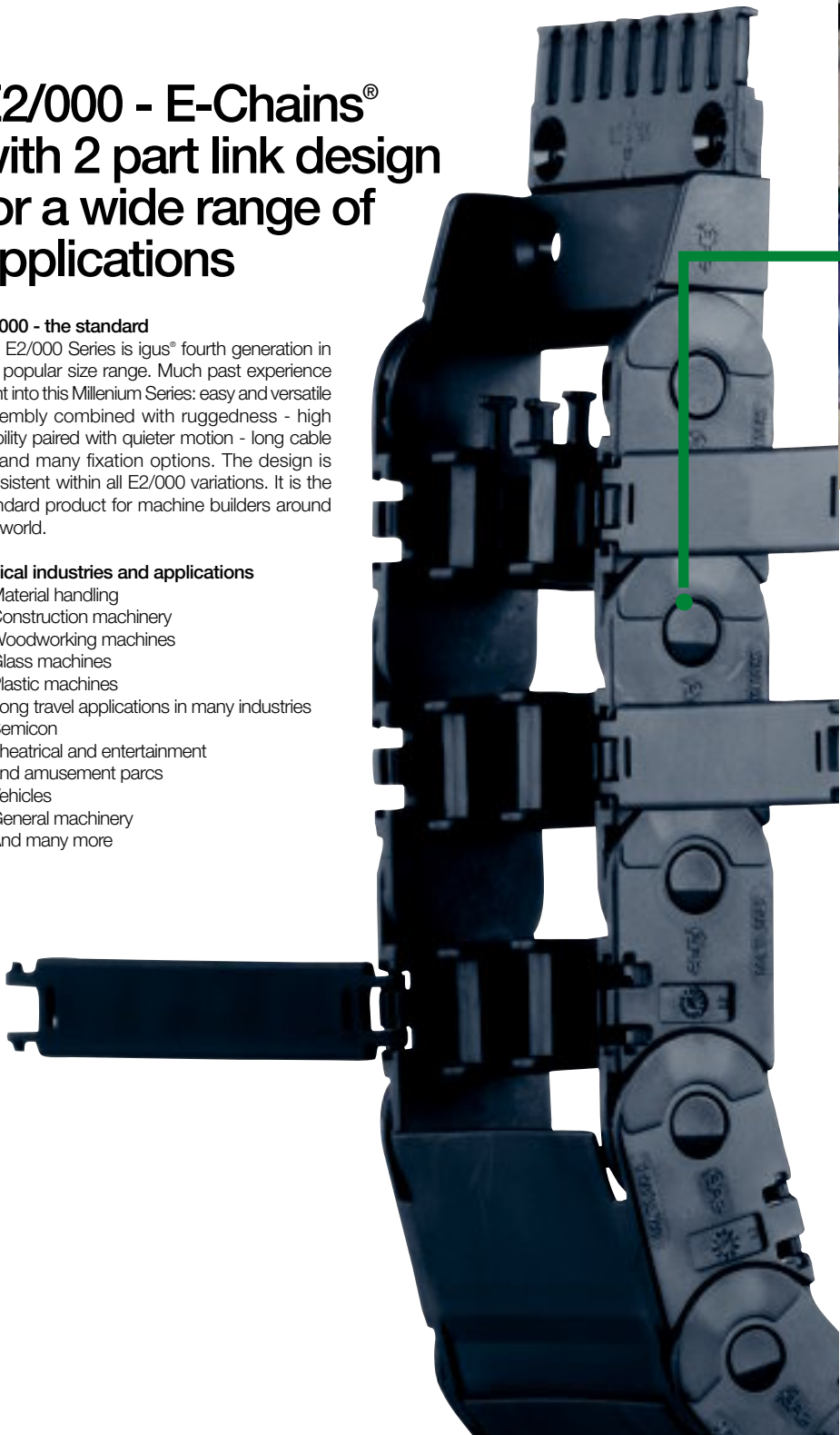



Harnessed E2/000 E-Chain® - turnkey solution delivered with cables and sheet metal parts directly to the machine



Electrically conductive ESD/ATEX version upon request



IPA Qualification Certificate Cleanroom ISO Class 3 (DIN 14644-1), at v = 2 m/s, with standard material igumid G



UL94-V2 classifications upon request



System E2/000 - 2-piece link-design



ESD/ATEX E-Chains® with PTB-certification as well as cleanroom materials with IPA-certification available ▶ page 1.35



Hanging application with Series 2400

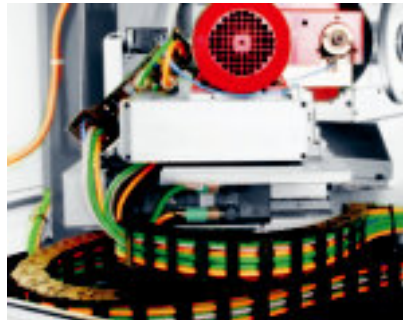

Side mounted application with Series 2500

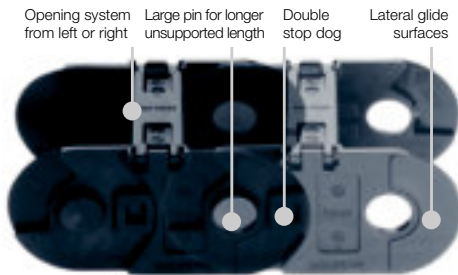
E2/000 E-Chains® - the standard for System E2

- Open crossbar left or right quickly with screwdriver or by hand - opening mechanism accessible from above
- Lightning-fast closing by hand - Secure fit without additional locking devices
- Secure fit of interior separation even when E-Chain® is open
- Excellent mechanical stability, long life due to design and material
- You can find more technical data about the material, chemical resistance, temperatures ► **chapter design, from page 1.38**

Selection table

Series	Inner height <i>hi</i> [mm]	Inner width <i>Bi</i> [mm]	Outer width <i>Ba</i> [mm]	Outer height <i>ha</i> [mm]	Bending radius <i>R</i> [mm]	Unsupported length max. [m]	Page
1400/1500	21	15 - 125	28,5 - 138,5	28	35 - 180	1,75	5.92
2400/2500	25	25 - 125	41,0 - 141,0	35	55 - 250	2,25	5.102
2600/2700	35	50 - 175	66,0 - 194,0	50	63 - 250	2,75	5.114
3400/3500	45	50 - 225	70,0 - 245,0	64	75 - 300	3,00	5.126
255	24	38 - 103	54,0 - 119,0	35	55 - 250	1,80	5.138

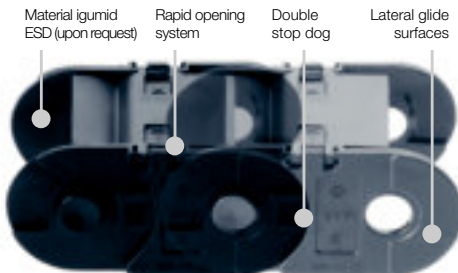
Two-piece half- and fully enclosed E-Tube

- Enclosed E-Tube can be used in chip areas (also hot chips)
- Snap-open mechanism, snap-open on left or right
- Opening mechanism accessible from above - rapid opening of the E-Tube with a screwdriver or by hand
- Lightning-fast closing by hand - Secure fit without additional locking devices
- Secure fit of interior separation even when E-Tube is open
- You can find more technical data about the material, chemical resistance, temperatures ► **chapter design, from page 1.38**

Selection table

Series	Inner height <i>hi</i> [mm]	Inner width <i>Bi</i> [mm]	Outer width <i>Ba</i> [mm]	Outer height <i>ha</i> [mm]	Bending radius <i>R</i> [mm]	Unsupported length max. [m]	Page
1450/1480	21	15 - 125	28,5 - 138,5	28	75 - 180	1,75	5.92
2450/2480	25	25 - 103	41,0 - 119,0	35	100 - 250	2,25	5.102
2650/2680	35	50 - 125	66,0 - 141,0	50	100 - 250	2,75	5.114
3450/3480	45	75 - 225	95,0 - 245,0	64	125 - 300	3,00	5.126



Assembling | E2/000



1 Push and click



2 Snap in pin



3 Swivel crossbars



4 Push and snap



5 Snap mounting bracket into link



6 Snap tiewrap plate into bottom groove

Separation | E2/000



1 Lever crossbars open



2 Release side-link



3 Twist and pull apart

Opening | Closing | E2/000 E-Tube



1 Open: swivel lids



2 Close: push and snap



3 Half E-Tube: swivel crossbars



4 Lever



5 Remove lid





Price index



IPA Qualification Certificate Air
Cleanless Class ISO Class 3
(at v = 2 m/s) upon request



ESD classification:
Electrically conductive ESD/ATEX
version upon request



UL94 V2 classifications
upon request



Snap-open mechanism, choice of snap-open on left or right. Hinged crossbar can be swiveled by more than 180° on both sides. Lightning-fast closing by hand. Secure fit without additional locking devices.



When to use the Series 1400/1450/1480/1500:

- If snap-open accessibility along inner or outer radius is required
- If integrated strain relief is required at the connection point
- If half E-Tube is required (Series 1450)
- If fully enclosed E-Tube is required (Series 1480)
- If long service life is required
- If easy installation is required
- Standard product with many accessories



When not to use it:

- If the application is very simple
 - ▶ Easy Chain®, Series E14, page 3.32

- ① Opening system for rapid opening, either from the right or the left
- ② Double stop dog for long unsupported length
- ③ Cross bars with high locking range
- ④ Series 1400 snap-open on both sides along inner radius
- ⑤ Series 1500 snap-open on both sides along outer radius
- ⑥ Series 1450 half E-Tube snap-open on both sides along inner radius
- ⑦ Series 1480 fully enclosed E-Tube snap-open on both sides along inner radius
- ⑧ Tried-and-tested mounting bracket
- ⑨ Modular interior separation
- ⑩ Easy assembly by optimized pin
- ⑪ Integrated strain relief possible
- ⑫ Also available as ESD version

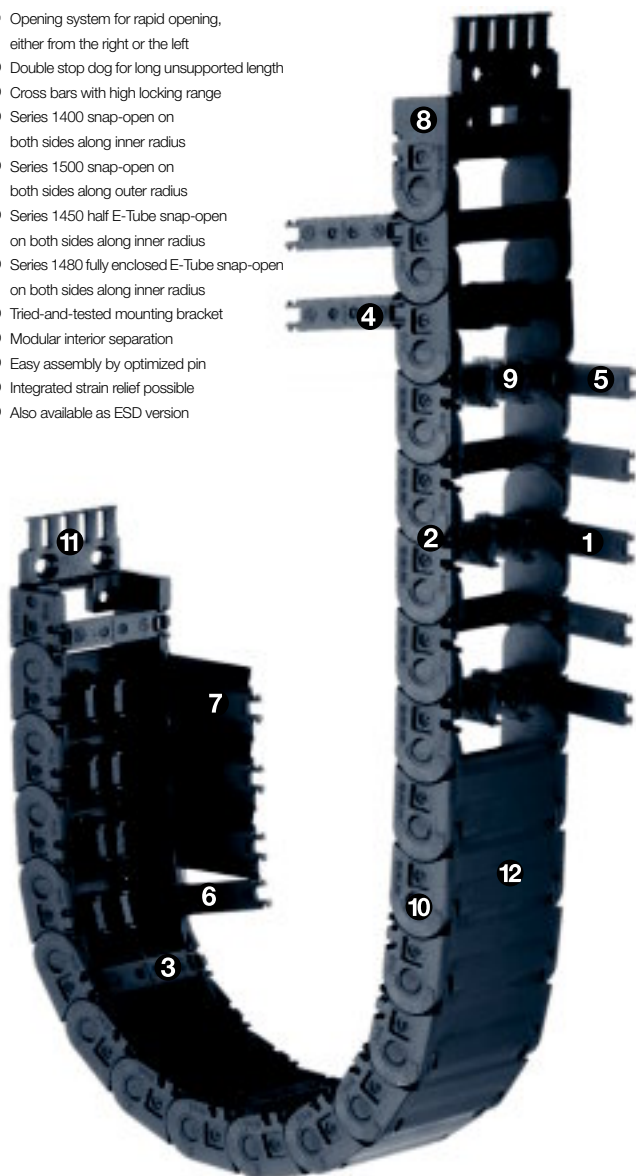

Order example complete E-Chain®

Please indicate chain-lengths or number of links Example: 3 m or 90 links

3 m 1400.038.100.0

E-Chain®

with 2 separators 14011 assembled every 2nd link

Interior separation

1 set 15000.038.34PZB

Mounting bracket



Unsupported length

FL_G = with straight upper run

FL_B = with permitted sag

Further information ► **Design, page 1.12**

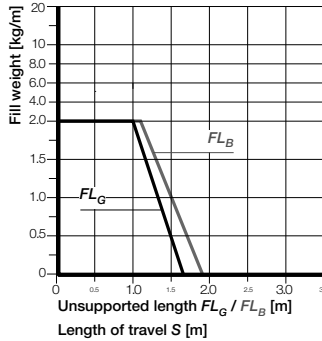
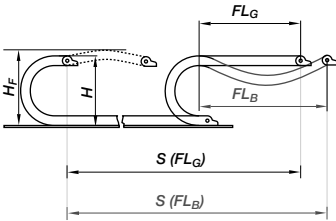

- S = Length of travel
 - R = Bending radius
 - H = Nominal clearance height
 - H_f = Required clearance height
 - H_{RI} = Trough inner height
 - D = Overlength E-Chain® radius in final position
 - $K = \pi \cdot R + \text{"safety"}$
 - D_2 = Over length - long travels, gliding
 - K_2 = "Further add-on"
 - H_2 = "Mounting height"
- *if the mounting bracket location is set lower

Other installation methods

- Vertical, hanging ≤ 20 m
- Vertical, standing ≤ 2 m
- Side mounted, un supp. $\leq 0,7$ m
- Rotary requires further calculation
- Unsupported length of upper run = upon request



Short travels - unsupported

Unsupported E-Chains® feature positive camber over short travels. This must be accounted for when specifying the clearance height H_f . Please consult igus® if space is particularly restricted.

The required clearance height:
 $H_f = H + 25$ mm
(with 0,5 kg/m fill weight)

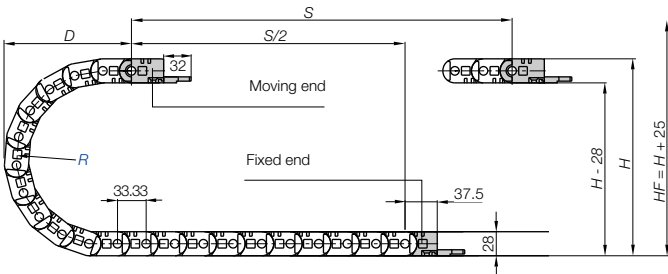

Pitch = 33,3 mm/link Links/m = 30 (1000 mm) Chain length = $S/2 + K$

R	035*	038*	048*	075	100	125	145	180
H	98	104	124	178	228	278	318	388
D	85	90	100	125	150	175	195	230
K	180	190	220	305	385	460	525	635
H_2	98	104	124	178	100	100	100	100
D_2^{*25}	85	90	100	125	340	495	540	690
K_2	180	190	220	305	600	800	940	1170

*for Series 1450/1480 upon request

Long travel lengths from 10 m to max. 75 m Chain length = $S/2 + K_2$

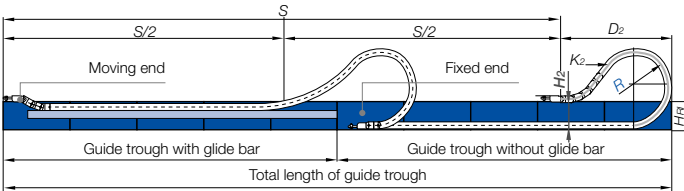

In case of travels between 4 and 10 m we recommend a longer unsupported length.



Gliding, long travel applications (max. 75 m)

In this case the E-Chain® upper run will be introduced in a guide trough on the lower run. We recommend to realize the engineering of such a plant by our technicians.

Technical Data

Speed / acceleration FL_G	max. 20 [m/s] / max. 200 [m/s ²]
Speed / acceleration FL_B	max. 3 [m/s] / max. 6 [m/s ²]
Gliding speed / acceleration (maximum)	max. 10 [m/s] / max. 50 [m/s ²]
Material - permitted temperature °C	igumid G / -40° up to +120° C
Flammability class, igumid G	VDE 0304 IIC UL94 HB



Details of material properties
► page 1.38



E2/000 medium
Inner height: 21 mm

Phone +49- (0) 22 03-96 49-800
Fax +49- (0) 22 03-96 49-222



► page 5.91

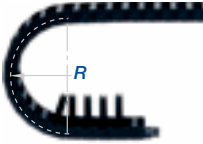
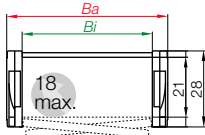

Part No. structure

1400.015.035.0



Series 1400 - E-Chain® - snap-open along inner radius

Part No.	Bi [mm]	Ba [mm]	R [mm]	Bending radii								Weight [kg/m]
1400.015.	15	28,5	035	038	048	075	100	125	145	180	~ 0,46	
1400.020.	20	33,5	035	038	048	075	100	125	145	180	~ 0,47	
1400.025.	25	38,5	035	038	048	075	100	125	145	180	~ 0,49	
1400.038.	38	51,5	035	038	048	075	100	125	145	180	~ 0,53	
1400.050.	50	63,5	035	038	048	075	100	125	145	180	~ 0,56	
1400.068.	68	81,5	035	038	048	075	100	125	145	180	~ 0,63	
1400.080.	80	93,5	035	038	048	075	100	125	145	180	~ 0,67	
1400.100.	100	113,5	035	038	048	075	100	125	145	180	~ 0,74	
1400.125.	125	138,5	035	038	048	075	100	125	145	180	~ 0,83	

Supplement Part No. with required radius. Example: 1400.015.035.0

0 = standard color, other colors ▶ page 1.39 · Pitch = 33,3 mm/link - Links/m = 30

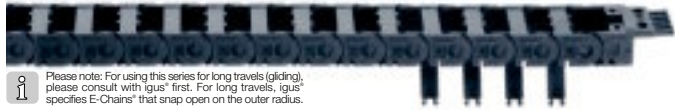

Please note: For using this series for long travels (gliding), please consult with igus® first. For long travels, igus® specifies E-Chains® that snap open on the outer radius.

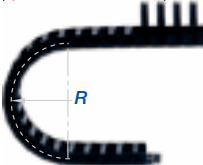
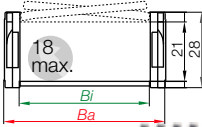

Part No. structure

1500.015.075.0



Series 1500 - E-Chain® - snap-open along outer radius - Standard!

Part No.	Bi [mm]	Ba [mm]	R [mm]	Bending radii								Weight [kg/m]
1500.015.	15	28,5	035	038	048	075	100	125	145	180	~ 0,46	
1500.020.	20	33,5	035	038	048	075	100	125	145	180	~ 0,47	
1500.025.	25	38,5	035	038	048	075	100	125	145	180	~ 0,49	
1500.038.	38	51,5	035	038	048	075	100	125	145	180	~ 0,53	
1500.050.	50	63,5	035	038	048	075	100	125	145	180	~ 0,56	
1500.068.	68	81,5	035	038	048	075	100	125	145	180	~ 0,63	
1500.080.	80	93,5	035	038	048	075	100	125	145	180	~ 0,67	
1500.100.	100	113,5	035	038	048	075	100	125	145	180	~ 0,74	
1500.125.	125	138,5	035	038	048	075	100	125	145	180	~ 0,83	

Supplement Part No. with required radius. Example: 1500.015.075.0

0 = standard color, other colors ▶ page 1.39 · Pitch = 33,3 mm/link - Links/m = 30



Series 1450 - half E-Tube - snap-open along inner radius

Part No.	<i>B_i</i> [mm]	<i>B_a</i> [mm]	<i>R</i> [mm]	Bending radii	Weight [kg/m]
1450.015.□.0	15	28,5	075	100 125 145 180	≈ 0,48
1450.025.□.0	25	38,5	075	100 125 145 180	≈ 0,57
1450.038.□.0	38	51,5	075	100 125 145 180	≈ 0,59
1450.050.□.0	50	63,5	075	100 125 145 180	≈ 0,65
1450.068.□.0	68	81,5	075	100 125 145 180	≈ 0,74
1450.080.□.0	80	93,5	075	100 125 145 180	≈ 0,80
1450.100.□.0	100	113,5	075	100 125 145 180	≈ 0,90
1450.125.□.0	125	138,5	075	100 125 145 180	≈ 1,03

The bending radii **035** **038** **048** are available upon request.

Supplement Part No. with required radius. Example: 1450.015.075.0

0 = standard color, other colors ▶ page 1.39 · Pitch = 33,3 mm/link - Links/m = 30



Please note: For using this series for long travels (gliding), please consult with igus® first. For long travels, igus® specifies E-Chains® that snap open on the outer radius.

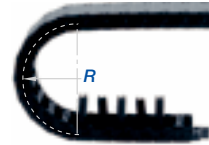
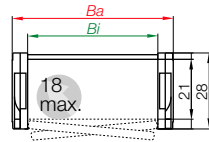

Part No. structure

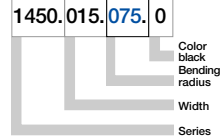

E2/000 medium
Inner height: 21 mm

Series 1480 - E-Tube - snap-open along inner radius

Part No.	<i>B_i</i> [mm]	<i>B_a</i> [mm]	<i>R</i> [mm]	Bending radii	Weight [kg/m]
1480.015.□.0	15	28,5	075	100 125 145 180	≈ 0,48
1480.025.□.0	25	38,5	075	100 125 145 180	≈ 0,54
1480.038.□.0	38	51,5	075	100 125 145 180	≈ 0,61
1480.050.□.0	50	63,5	075	100 125 145 180	≈ 0,67
1480.068.□.0	68	81,5	075	100 125 145 180	≈ 0,77
1480.080.□.0	80	93,5	075	100 125 145 180	≈ 0,84
1480.100.□.0	100	113,5	075	100 125 145 180	≈ 0,95
1480.125.□.0	125	138,5	075	100 125 145 180	≈ 1,08

The bending radii **035** **038** **048** are available upon request.

Supplement Part No. with required radius. Example: 1480.038.075.0

0 = standard color, other colors ▶ page 1.39 · Pitch = 33,3 mm/link - Links/m = 30



Please note: For using this series for long travels (gliding), please consult with igus® first. For long travels, igus® specifies E-Chains® that snap open on the outer radius.

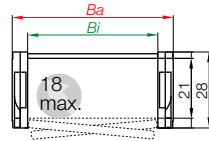

Part No. structure

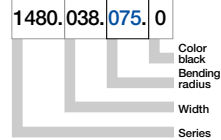

Phone +49- (0) 22 03-96 49-800
Fax +49- (0) 22 03-96 49-222



▶ page 5.91

Vert. Separator, slotted		
unassembled	14001	
assembled	14011	

Option 1: Vertical Separators for E-Chains® Series 1400 · 1500

Vertical Separators are used if a vertical subdivision of the E-Chain® interior is required -

By standard Vertical Separators are assembled every other E-Chain® link

- Standard subdivision with Vertical Separator, slotted 14011, for combinations with Full-Width Shelf 111.X

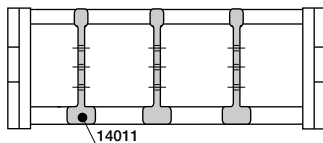

Vert. Separator, slotted		
unassembled	14501	
assembled	14511	

Option 2: Vertical Separators for E-Tubes Series 1450 · 1480

Vertical Separators are used if a vertical subdivision of the half E-Tube (Series 1450) and the fully enclosed E-Tube (Series 1480) interior is required -

By standard Vertical Separators are assembled every other E-Chain® link

- Standard subdivision with Vertical Separator, slotted 14511, for combinations with Full-Width Shelf 111.X

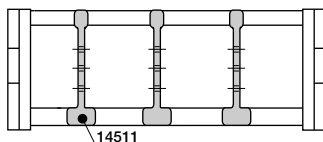

Option 3: Full-Width Shelves for E-Chains® Series 1400 · 1500 and E-Tubes Series 1450 · 1480

For applications involving many cables with similar or identical diameters

- Full-Width Shelf 111.X can be combined with Vertical Separator, slotted 14011 (E-Chain®) and Vertical Separator, slotted 14511 (E-Tube/half E-Tube)

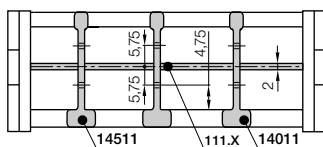

Full-Width Shelf	
X	
t=2	

Width X [mm]	Part No. unassembled	Part No. assembled
015	110.15	111.15
020	110.20	111.20
025	110.25	111.25
038	110.38	111.38
050	110.50	111.50

Width X [mm]	Part No. unassembled	Part No. assembled
068	110.68	111.68
080	110.80	111.80
100	110.100	111.100
125	110.125	111.125

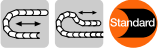

The Standard - one-piece mounting brackets - pivoting

- Recommended for unsupported and gliding applications
- Well suited for tight installation conditions
- Integrated multistage strain relief
- Easy to assemble
- Various mounting positions

Moving end with bore (outer link) 14...3PZ

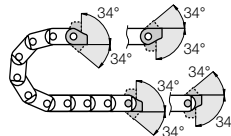

14...4PZ Fixed end with pin (inner link)

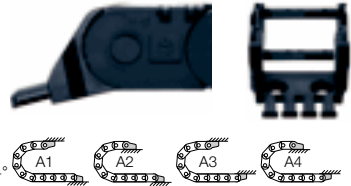

Possible installation conditions for assembled mounting brackets ▶ Order example "preassembled" below

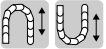

One-piece mounting brackets - locking

- Recommended for unsupported and gliding applications
- Furthermore:
- At very high speed and/or acceleration
 - If space is limited for height (the H_F measurement)
 - Various mounting positions

Moving end with bore (outer link) 14...1PZ

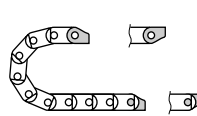

14...2PZ Fixed end with pin (inner link)



Possible installation conditions for assembled mounting brackets ▶ Order example "preassembled" below

14...3PZ Standard! (pivoting)
14...1PZ (locking)

Moving end

Standard! (pivoting) 14...4PZ (locking) 14...2PZ

Fixed end

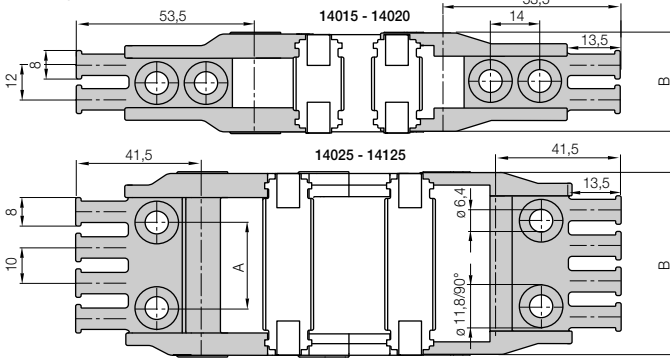

For E-Chain:	Part No. full set with tiewrap plate	Dim.A [mm]	Dim.B [mm]	Number of teeth
1400 - 1500.015 ▶	14015. [] PZ	-	28,5	2
1400 - 1500.020 ▶	14020. [] PZ	-	33,5	2
1400 - 1500.025 ▶	14025. [] PZ	13	38,5	2
1400 - 1500.038 ▶	14038. [] PZ	24	51,5	4
1400 - 1500.050 ▶	14050. [] PZ	36	63,5	6
1400 - 1500.068 ▶	14068. [] PZ	54	81,5	7
1400 - 1500.080 ▶	14080. [] PZ	66	93,5	8
1400 - 1500.100 ▶	14100. [] PZ	86	113,5	10
1400 - 1500.125 ▶	14125. [] PZ	111	138,5	13

Please add the Part No. with the requested index - 34 for the pivoting configuration

e.g. 14015. [34] PZ or 12 for the locking configuration e.g. 14015. [12] PZ

For the preassembled mode please add the index [A1] ... [A4] e.g. 14015. [34] PZ [A1]

Dimensions and order configurations

Strain relief is possible on the moving end and/or the fixed end.

Part No. structure (pivoting)

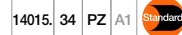

A... must be indicated on preassembled configurations
With assembled strain relief tiewrap plates
Full set pivoting = 34
Mounting brackets for selected chain type

Full set, for both ends:

[14015. [34] PZ] +tiewrap plate

Single-part order:

[14015. [3] PZ] +tiewrap plate

Mounting bracket with bore

[14015. [4] PZ] +tiewrap plate

Mounting bracket with pin

Part No. structure (locking)

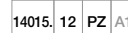

A... must be indicated on preassembled configurations
With assembled strain relief tiewrap plates
Full set pivoting = 12
Mounting brackets for selected chain type

Full set, for both ends:

[14015. [12] PZ] +tiewrap plate

Single-part order:

[14015. [1] PZ] +tiewrap plate

Mounting bracket with bore

[14015. [2] PZ] +tiewrap plate

Mounting bracket with pin



▶ page 5.91

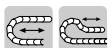

Mounting bracket - polymer

- Recommended for unsupported and gliding applications
- Well suited for tight installation conditions
- Strain relief with detachable tiwrap plates
- Variable traverse angle for flexible assembly
- The twistability of the E-Chain® and the option to assemble the mounting brackets on the fixed end and/or the moving end, enable various installation options

Moving end with bore
(outer link) 15000...3PZ(B)

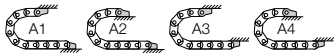
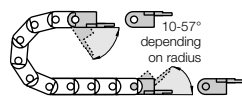

Possible installation conditions for assembled mounting brackets ▶ Order example "preassembled" below

15000...4PZ(B) Fixed end with pin (inner link)

Dimensions and order configurations

Strain relief is possible on the moving end and/or the fixed end.

15000...3PZ(B)
Moving end

15000...4PZ(B)
Fixed end

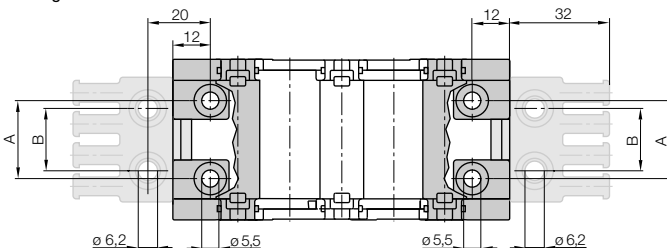

Part No. structure

15000.038.34.PZB.A1

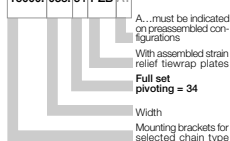

Full set, for both ends:

15000.038.34.PZB +tiwrap plate

Single-part order:

15000.038.3.PZB +tiwrap plate

Mounting bracket with bore

15000.038.4.PZB +tiwrap plate

Mounting bracket with pin

For E-Chain®	Part No. full set with tiwrap plate	Part No. full set without tiwrap plate	Dim. A [mm]	Dim. B [mm]
1400 - 1500.015 ▶	-	-	-	-
1400 - 1500.020 ▶	-	-	-	-
1400 - 1500.025 ▶	15000.025.34.PZB	15000.025.34.PZ	12	15
1400 - 1500.038 ▶	15000.038.34.PZB	15000.038.34.PZ	25	20
1400 - 1500.050 ▶	15000.050.34.PZB	15000.050.34.PZ	37	30
1400 - 1500.068 ▶	15000.068.34.PZB	15000.068.34.PZ	55	40
1400 - 1500.080 ▶	15000.080.34.PZB	15000.080.34.PZ	67	60
1400 - 1500.100 ▶	15000.100.34.PZB	15000.100.34.PZ	87	80
1400 - 1500.125 ▶	15000.125.34.PZB*	15000.125.34.PZ	112	105

For the preassembled mode please add the index [A1] ... [A4] e.g. 15000.038.34.PZB[A1]

*Tie wrap plate (consists of 2 x 2050.ZB) does not snap on but needs to be bolted down separately

Phone +49- (0) 22 03-96 49-800
Fax +49- (0) 22 03-96 49-222

igus® GmbH
51147 Cologne

Internet: www.igus.eu
E-mail: info@igus.de



Steel mounting bracket - locking

- Locked connections
- One part for all chain widths
- Electrically conductive
- Bolted connection outside of chain cross-section possible

Moving end with bore
(outer link) 14000....1

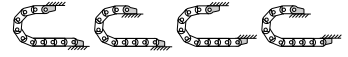
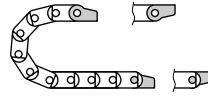

14000...2 Fixed end
with pin (inner link)

Possible installation conditions -
Further installation angles ► installation sketch

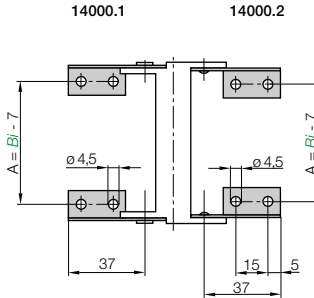
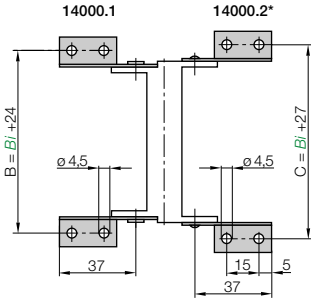

Dimensions and order configurations

*pivoting with no stop, (360°).
Screw-on area of the mounting brackets can be on the interior or exterior.

For E-Chain*	Part No. full set	Dim. A [mm]	Dim. B [mm]	Dim. C [mm]
1400 - 1500.015 ►	14000. 12	8	39	42
1400 - 1500.020 ►	14000. 12	13	44	47
1400 - 1500.025 ►	14000. 12	18	49	52
1400 - 1500.038 ►	14000. 12	31	62	65
1400 - 1500.050 ►	14000. 12	43	74	77
1400 - 1500.068 ►	14000. 12	61	92	95
1400 - 1500.080 ►	14000. 12	73	104	107
1400 - 1500.100 ►	14000. 12	93	124	127
1400 - 1500.125 ►	14000. 12	118	149	152

14000. 12 Full set, 4 parts
2 with pin / 2 with bore

Single-part order:

14000. 1 Mounting bracket with bore, 1 part left / right

14000. 2 Mounting bracket with pin, 1 part left / right

Phone +49- (0) 22 03-96 49-800
Fax +49- (0) 22 03-96 49-222



igus® E-ChainSystems®

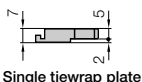

Single tie-wrap plate

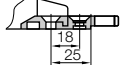

Shown assembled

Tie-wrap plate as individual part

As individual component screwed on KMA. Can be plugged in the mounting brackets. **Details ► chapter 10**

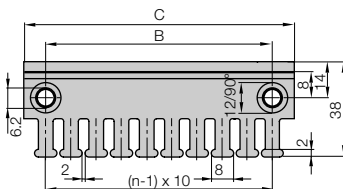

Tie-wrap plate	No. of teeth <i>n</i>	Dim. C [mm]	Dim. B [mm]
2020.ZB	3	30	15
2030.ZB	4	40	20
2040.ZB	5	50	30
2050.ZB	6	60	40
2070.ZB	8	80	60
2090.ZB =			
(2030.ZB + 2040.ZB)	9	90	–
2100.ZB	10	100	80
2125.ZB =			
(2050.ZB + 2050.ZB)	12	120	–

Phone +49- (0) 22 03-96 49-800
Fax +49- (0) 22 03-96 49-222



Cable tiewraps as individual part

Cable tiewraps (100-piece bag)	Width x length	max. Ø	Tensile strength
CFB.001	4,8 x 150 mm	36 mm	222 N



Strain relief for steel mounting brackets

Clip-on connection is not possible with steel mounting brackets. In this case, the tie-wrap plates must be bolted directly into separate bore holes in front of the mounting bracket. Alternatively the tie-wrap plates 20XX.ZB can be also used here. **Details ► chapter 10**

igus® GmbH
51147 Cologne



Other strain relief elements - optional ► chapter 10

Internet: www.igus.eu
E-mail: info@igus.de

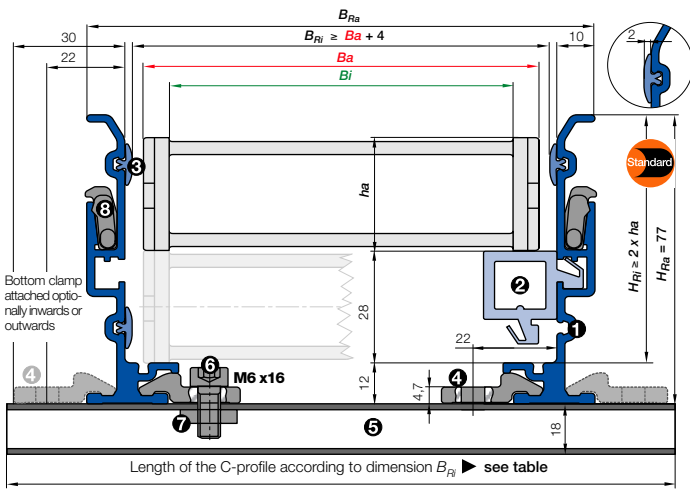

- B_a = Outer width E-Chains® / E-Tube
 - B_i = Inner width E-Chains® / E-Tube
 - h_a = Outer height E-Chains® / E-Tube
 - H_{Ri} = Inner trough height
 - H_{Ra} = Outer trough height
 - B_{Ri} = Inner trough width ▶ depends on dim. B_a
 - B_{Ra} = Outer trough width
 - n_{Mon} = Number of installation sets (left/right)
 - n_{Ri} = Number of trough sets (left/right)
- $H_{Ri} \geq 2 \cdot h_a$
 $B_{Ri} \geq B_a + 4$
- = Guide trough set
 - = Installation set "Basic"
 - = C-profile
 - = Glide bar

Installation set "Basic" with C-profile

Bottom Clamp attached optionally inwards or outwards

1500.050.035.0 ▶ Order example

B_{Ri} [mm]	Part No. attached	
	inwards	outwards
.015	33	960.30.125
.020	38	960.30.125
.025	43	960.30.150
.038	56	960.30.150
.050	68	960.30.125 960.30.175
.068	86	960.30.150 960.30.175
.080	98	960.30.150 960.30.200
.100	118	960.30.175 960.30.225
.125	143	960.30.200 960.30.250



- **Components, trough "Basic":** ① Trough side parts, aluminum, 2 m ② Glide bar, plastic, 2 m ③ Glide strips, plastic, 2 m (without glide strips on request)
- **Components, installation set "Basic":** ④ Bottom clamp, aluminum ⑤ C-profile, steel galvanized ⑥ Screw M6 x16 ⑦ Sliding nut M6 ⑧ Interface connector, plastic

Order example: Length of travel 30 m - Center mounted for Series 1500.050.035.0 with $B_{Ri} = 68$

- Guide trough set (set of 2 trough side parts, incl. glide strips) **without** glide bar
- Order text: 16 m guide trough without glide bar (8 x 2 m sections) Part No. 970.30.SL**
- Guide trough set (set of 2 trough side parts, incl. glide strips) **with** glide bar
- Order text: 16 m guide trough with glide bar (8 x 2 m sections) Part No. 970.32.SL**
- Installation set "Basic" complete (guide trough-sets + 1)
- Order text: 17 installation sets "Basic" Part No. 960.30.125**
- Module for the fixed end
- Order text: 1 set Part No. 970.80**
- Option:** For an additional noise dampening with silencer profile, please add Index A - Example: **Part No. 970.30.SLA**

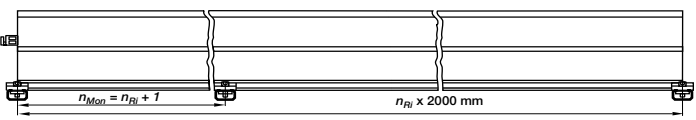

Principle sketch: Number of installation sets to be installed = **Number of trough sections + 1**



A quick fix for mounting the stationary end of an E-Chain®
 With this module for the fixed end, fast and easy mounting onto the Aluminum "SuperTrough" is now possible without any drilling. Fast mounting of the E-Chain® by clamping onto the aluminum trough

- Quick relocation of the stationary end
- No drilling necessary

Phone +49- (0) 22 03-96 49-800
 Fax +49- (0) 22 03-96 49-222

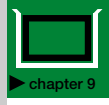
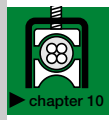
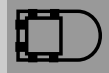

● ● ● Price index



IPA Qualification Certificate Air
Cleanless Class ISO Class 3
(at v = 2 m/s)



ESD classification:
Electrically conductive ESD/ATEX
version upon request



UL94 V2 classifications
upon request



Snap-open mechanism, choice of snap-open on left or right. Hinged crossbar can be swiveled by more than 180° on both sides. Lightning-fast closing by hand. Secure fit without additional locking devices.



When to use the Series 2400/2450/2480/2500:

- Snap-open accessibility along both radii
- If integrated strain relief is required at the connection point
- Modular interior separation
- If long service life is required
- If easy installation is required
- If half E-Tube is required (Series 2450)
- If fully enclosed E-Tube is required (Series 2480)



When not to use it:

- If maximum stability is required
 - ▶ System E4.1, Series E4.21, page 7.16
- If the application is very simple
 - ▶ Easy Chain®, Series E200, page 3.36
- E-Tubes with small bending radii 060, 075
 - ▶ System E2 E-Tubes, Series R48, page 6.26

- ① Double stop dog for long unsupported length
- ② Opening system for rapid opening, either from the right or the left
- ③ Cross bars with high locking range
- ④ Lateral glide surfaces for side-mounted operation
- ⑤ Tried-and-tested mounting bracket
- ⑥ Integrated strain relief possible
- ⑦ Series 2400 and 2450 snap-open along inner radius
- ⑧ Series 2450 half E-Tube snap-open along inner radius, either from the right or the left
- ⑨ Fully enclosed E-Tube Series 2480 snap-open along inner radius
- ⑩ Modular interior separation
- ⑪ Easy assembly by optimized pin
- ⑫ Also available as ESD version
- ⑬ **Strain relief separator** - Separator with integrated strain relief ▶ page 5.112

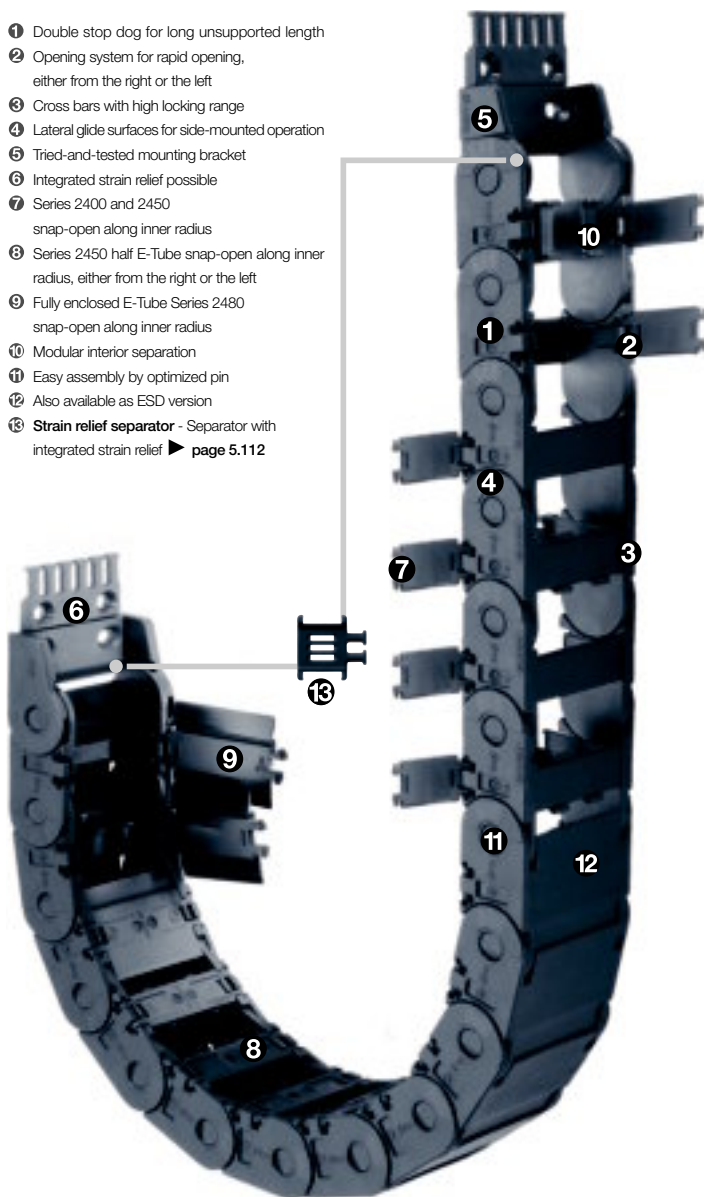

Order example complete E-Chain®

Please indicate chain-lengths or number of links Example: 3 m or 66 links

3 m 2500.10.100.0

E-Chain®

with 2 separators 211 assembled every 2nd link

Interior separation

1 set 2100.34PZB+

Mounting bracket



Unsupported length

FL_G = with straight upper run

FL_B = with permitted sag

Further information ► **Design, page 1.12**

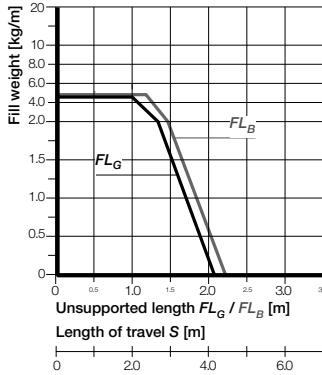
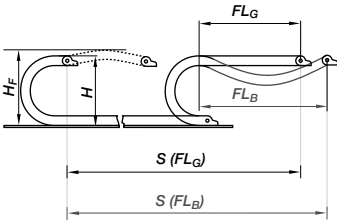

- S = Length of travel
 - R = Bending radius
 - H = Nominal clearance height
 - H_F = Required clearance height
 - H_{RI} = Trough inner height
 - D = Overlength E-Chain® radius in final position
 - $K = \pi \cdot R + \text{"safety"}$
 - D_2 = Over length - long travels, gliding
 - K_2 = "Further add-on"
 - H_2 = "Mounting height"
- *if the mounting bracket location is set lower

Other installation methods

- Vertical, hanging ≤ 40 m
- Vertical, standing ≤ 3 m
- Side mounted, un supp. ≤ 1 m
- Rotary requires further calculation
- Unsupported length of upper run = upon request



Short travels - unsupported

Unsupported E-Chains® feature positive camber over short travels. This must be accounted for when specifying the clearance height H_F . Please consult igus® if space is particularly restricted.

The required clearance height:

$$H_F = H + 25 \text{ mm}$$

(with 1,5 kg/m fill weight)

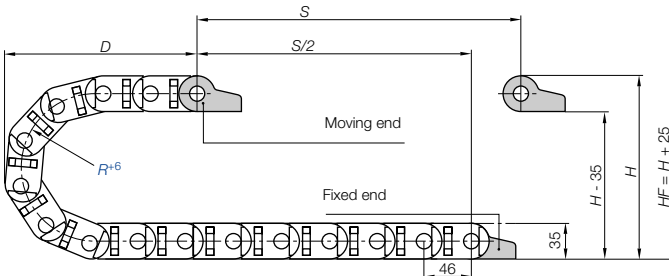

Pitch = 46 mm/link Links/m = 22 (1012 mm) Chain length = $S/2 + K$

R	055*	075*	100	125	150	175	200	225	250
H	145	185	235	285	335	385	435	485	535
D	125	150	170	195	220	245	270	295	320
K	276	346	414	496	578	660	742	814	920
H ₂	145	185	100	100	100	100	100	100	100
D ₂ ⁺²⁵	125	150	380	440	590	755	950	1040	1130
K ₂	276	346	644	736	1012	1242	1472	1610	1794

*for Series 2450/2480 upon request

Long travel lengths from 10 m to max. 100 m Chain length = $S/2 + K_2$

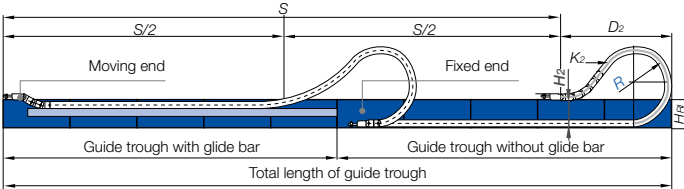

In case of travels between 4 and 10 m we recommend a longer unsupported length.



Gliding, long travel applications (max. 100 m)

In this case the E-Chain® upper run will be introduced in a guide trough on the lower run. We recommend to realize the engineering of such a plant by our technicians.

Technical Data

Speed / acceleration FL_G	max. 20 [m/s] / max. 200 [m/s ²]
Speed / acceleration FL_B	max. 3 [m/s] / max. 6 [m/s ²]
Gliding speed / acceleration (maximum)	max. 10 [m/s] / max. 50 [m/s ²]
Material - permitted temperature °C	igumid G / -40° up to +120° C
Flammability class, igumid G	VDE 0304 IIC UL94 HB



Details of material properties
► page 1.38

For support of the lower run - **Support Tray tool kit** available ► page 9.70



E2/000 medium
Inner height: 25 mm

Phone +49- (0) 22 03-96 49-800
Fax +49- (0) 22 03-96 49-222



► page 5.91

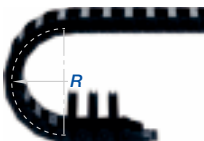
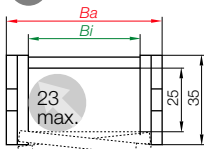

Part No. structure

2400. 02. 055. 0



Series 2400 E-Chain® - snap-open along inner radius

Part No.	<i>Bj</i> [mm]	<i>Ba</i> [mm]	<i>R</i> [mm]	Bending radii										Weight [kg/m]
2400.02.□.0	25	41	055	075	100	125	150	175	200	225	250	= 0,77		
2400.03.□.0	38	54	055	075	100	125	150	175	200	225	250	= 0,83		
2400.05.□.0	57	73	055	075	100	125	150	175	200	225	250	= 0,91		
2400.07.□.0	77	93	055	075	100	125	150	175	200	225	250	= 1,01		
2400.09.□.0	89	105	055	075	100	125	150	175	200	225	250	= 1,08		
2400.10.□.0	103	119	055	075	100	125	150	175	200	225	250	= 1,15		
2400.12.□.0	125	141	055	075	100	125	150	175	200	225	250	= 1,22		

Supplement Part No. with required radius. Example: 2400.02.□055□.0

0 = standard color, other colors ▶ page 1.39 · Pitch = 46 mm/link - Links/m = 22

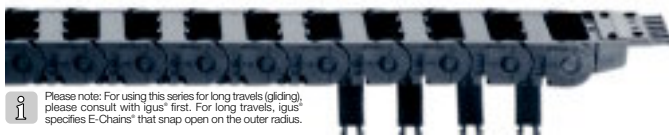

Please note: For using this series for long travels (gliding), please consult with igus® first. For long travels, igus® specifies E-Chains® that snap open on the outer radius.

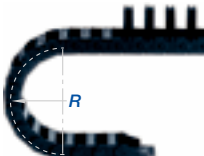
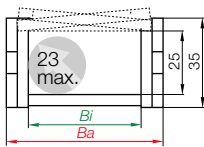

Part No. structure

2500. 02. 055. 0



Series 2500 - E-Chain® - snap-open along outer radius - Standard!

Part No.	<i>Bj</i> [mm]	<i>Ba</i> [mm]	<i>R</i> [mm]	Bending radii										Weight [kg/m]
2500.02.□.0	25	41	055	075	100	125	150	175	200	225	250	= 0,77		
2500.03.□.0	38	54	055	075	100	125	150	175	200	225	250	= 0,83		
2500.05.□.0	57	73	055	075	100	125	150	175	200	225	250	= 0,91		
2500.07.□.0	77	93	055	075	100	125	150	175	200	225	250	= 1,01		
2500.09.□.0	89	105	055	075	100	125	150	175	200	225	250	= 1,08		
2500.10.□.0	103	119	055	075	100	125	150	175	200	225	250	= 1,15		
2500.12.□.0	125	141	055	075	100	125	150	175	200	225	250	= 1,22		

Supplement Part No. with required radius. Example: 2500.02.□055□.0

0 = standard color, other colors ▶ page 1.39 · Pitch = 46 mm/link - Links/m = 22



Series 2450 - half E-Tube - snap-open along inner radius

Part No.	Bi [mm]	Ba [mm]	R [mm]	Bending radii	Weight [kg/m]
2450.02.□.0	25	41	100	125 150 175 200 225 250	≈ 0,80
2450.03.□.0	38	54	100	125 150 175 200 225 250	≈ 0,88
2450.05.□.0	57	73	100	125 150 175 200 225 250	≈ 0,99
2450.07.□.0	77	93	100	125 150 175 200 225 250	≈ 1,12
2450.09.□.0	89	105	100	125 150 175 200 225 250	≈ 1,20
2450.10.□.0	103	119	100	125 150 175 200 225 250	≈ 1,27
2450.12.□.0	125	141	100	125 150 175 200 225 250	≈ 1,35

The widths **Bi 125** are available upon request. Time of delivery approx. 6-8 weeks after order.

The bending radii **055 | 075** are available upon request.

Supplement Part No. with required radius. Example: 2450.02.100.0

0 = standard color, other colors ▶ page 1.39 · Pitch = 46 mm/link - Links/m = 22

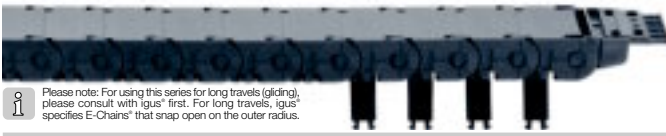

Please note: For using this series for long travels (gliding), please consult with igus® first. For long travels, igus® specifies E-Chains® that snap open on the outer radius.

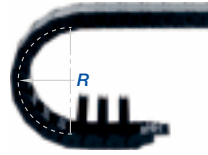
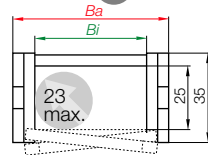

Part No. structure

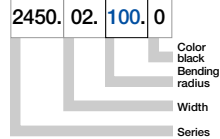

E2/000 medium
Inner height: 25 mm

Series 2480 - E-Tube - snap-open along inner radius

Part No.	Bi [mm]	Ba [mm]	R [mm]	Bending radii	Weight [kg/m]
2480.02.□.0	25	41	100	125 150 175 200 225 250	≈ 0,82
2480.03.□.0	38	54	100	125 150 175 200 225 250	≈ 0,92
2480.05.□.0	57	73	100	125 150 175 200 225 250	≈ 1,03
2480.07.□.0	77	93	100	125 150 175 200 225 250	≈ 1,17
2480.09.□.0	89	105	100	125 150 175 200 225 250	≈ 1,26
2480.10.□.0	103	119	100	125 150 175 200 225 250	≈ 1,34
2480.12.□.0	125	141	100	125 150 175 200 225 250	≈ 1,43

The widths **Bi 25/125** are available upon request. Time of delivery approx. 6-8 weeks after order.

The bending radii **055 | 075** are available upon request.

Supplement Part No. with required radius. Example: 2480.03.100.0

0 = standard color, other colors ▶ page 1.39 · Pitch = 46 mm/link - Links/m = 22

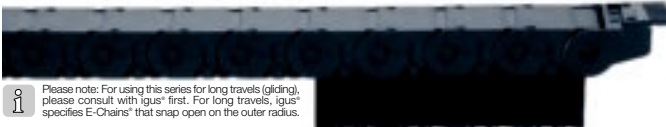

Please note: For using this series for long travels (gliding), please consult with igus® first. For long travels, igus® specifies E-Chains® that snap open on the outer radius.

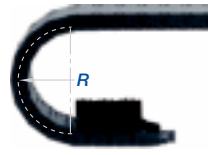
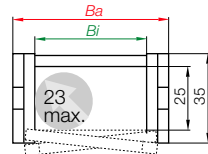

Part No. structure

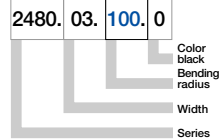

For smaller bending radii we recommend the fully closed E-Tubes, Series R48 ▶ page 6.34

Phone +49- (0) 22 03-96 49-800
Fax +49- (0) 22 03-96 49-222



▶ page 5.91



Vertical Separator	
unassembled	201
assembled	211



Vertical Separator*	
unassembled	201.28
assembled	211.28



Spacer*	
unassembled	205.09
assembled	215.09



Strain Relief Separator	
unassembled	2020.Z
assembled	2120.Z



*For side-mounted applications

Option 1: Vertical Separators and Spacer for E-Chains®

Vertical Separators are used if a vertical subdivision of the E-Chain® interior is required -

By standard Vertical Separators are assembled every other E-Chain® link

- **Standard:** subdivision (Series 2400/Series 2500) with Vertical Separator 211
- If a broad distance shall be kept between the separators or they have to be fixed in their position, e.g. in case of side mounted applications, **Separators with wide base 211.28** or **Spacer 215.09** (not for openable crossbars) can be used
- **Strain Relief Separator 2020.Z**, integrable in the mounting bracket, to position at any point

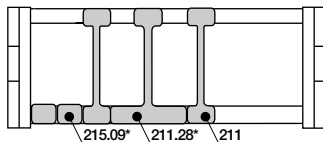

Vert. Separator, slotted	
unassembled	202
assembled	212



Side Plate	
unassembled	203
assembled	213



Full-Width Shelf	
X - 1	
t = 2,5	

Option 2: Full-Width Shelves for E-Chains®

For applications involving many thin cables with similar or identical diameters

- Vertical Separator, slotted 212 and Side Plate 213 - for applications with Full-Width Shelf 221.X

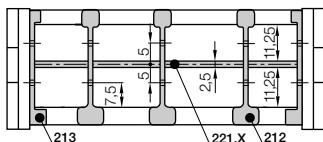

Width X [mm]	Part No. unassembled	Part No. assembled
025	220.25	221.25
038	220.38	221.38
057	220.57	221.57
077	220.77	221.77

Width X [mm]	Part No. unassembled	Part No. assembled
090	220.90	221.90
103	220.103	221.103
125	220.125	221.125

Side Plate	
unassembled	2030
assembled	2130



Vert. Separator, slotted	
unassembled	2040
assembled	2140



Middle Plate	
unassembled	2020
assembled	2120



Shelf	
X	
X - 7	
t = 2,5	

Option 3: Shelves for E-Chains®

For applications involving many cables with different diameters. The Shelves can be arranged elevator-shifted with different bottoms within the entire E-Chain® width.

- Shelf 2210.X can be combined with Middle Plate 2120,

Vertical Separator, slotted 2140 and Side Plate 2130

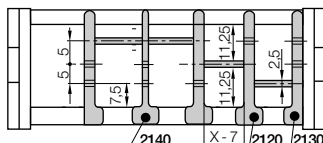

Width X [mm]	Part No. unassembled	Part No. assembled
018	2200.18	2210.18
023	2200.23	2210.23
028	2200.28	2210.28
033	2200.33	2210.33
038	2200.38	2210.38
043	2200.43	2210.43

Width X [mm]	Part No. unassembled	Part No. assembled
048	2200.48	2210.48
058	2200.58	2210.58
068	2200.68	2210.68
073	2200.73	2210.73
088	2200.88	2210.88
099	2200.99	2210.99

Option 4: Vertical Separators for E-Tubes

Vertical Separators are used if a vertical subdivision of the E-Tube interior is required -

By standard Vertical Separators are assembled every other E-Tube link

- Standard subdivision of the half E-Tube (Series 2450) and the fully enclosed E-Tube (Series 2480) with Vertical Separator, slotted 24511, for combinations with Full-Width Shelf 221.X
- Strain Relief Separator 2020.ZR, integrable in the mounting bracket, to position at any point

Vert. Separator, slotted		
unassembled	24501	
assembled	24511	

Strain Relief Separator		
unassembled	2020.ZR	
assembled	2120.ZR	

E2/000 medium
Inner height: 25 mm

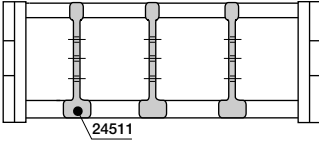

Option 5: Full-Width Shelves for E-Tubes

For applications involving many thin cables with similar or identical diameters

- Vertical Separator, slotted 24511 - for applications with Full-Width Shelf 221.X

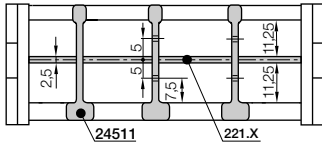

Width X [mm]	Part No. unassembled	Part No. assembled
025	220.25	221.25
038	220.38	221.38
057	220.57	221.57
077	220.77	221.77

Width X [mm]	Part No. unassembled	Part No. assembled
090	220.90	221.90
103	220.103	221.103
125	220.125	221.125

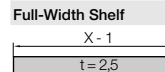

Phone +49- (0) 22 03-96 49-800
Fax +49- (0) 22 03-96 49-222



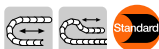

The Standard - option polymer - pivoting

- Recommended for unsupported and gliding applications
- Well suited for tight installation conditions
- Strain relief with detachable tiwrap plates
- Variable traverse angle for flexible assembly
- The twistability of the E-Chain® and the option to assemble the mounting brackets on the fixed end and/or the moving end, enable various installation options

Moving end with bore
(outer link) 2...3PZ(B)+

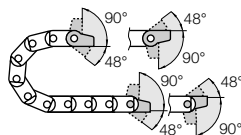

2...4PZ(B)+ Fixed end
with pin (inner link)

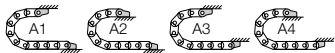

Possible installation conditions for assembled mounting brackets ▶ Order example "preassembled" below

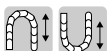

Option polymer - locking

- Recommended for unsupported and gliding applications
- At very high speed and/or acceleration
- If space is limited for height (the H_F measurement)
- The twistability of the E-Chain® and the option to assemble the mounting brackets on the fixed end and/or the moving end, enable various installation options

Moving end with bore
(outer link) 2...1PZ(B)+

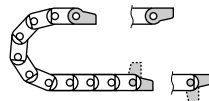

2...2PZ(B)+ Fixed end
with pin (inner link)



Possible installation conditions for assembled mounting brackets ▶ Order example "preassembled" below

Dimensions and order configurations

Strain relief is possible on the moving end and/or the fixed end.

Part No. structure (pivoting)

2020. 34 PZB+ A1 Standard!

A... must be indicated on preassembled configurations
With assembled strain relief tiwrap plates
Full set pivoting = 34
Mounting brackets for selected chain type

Full set, for both ends:

2020. 34 PZB+ +tiwrap plate

Single-part order:

2020. 3 PZB+ +tiwrap plate

Mounting bracket with bore

2020. 4 PZB+ +tiwrap plate

Mounting bracket with pin

Part No. structure (locking)

2020. 12 PZB+ A1

A... must be indicated on preassembled configurations
With assembled strain relief tiwrap plates
Full set locking = 12
Mounting brackets for selected chain type

Full set, for both ends:

2020. 12 PZB+ +tiwrap plate

Single-part order:

2020. 1 PZB+ +tiwrap plate

Mounting bracket with bore

2020. 2 PZB+ +tiwrap plate

Mounting bracket with pin

2...3PZ(B)+ Standard! (pivoting)

2...1PZ(B)+ (locking)

Moving end

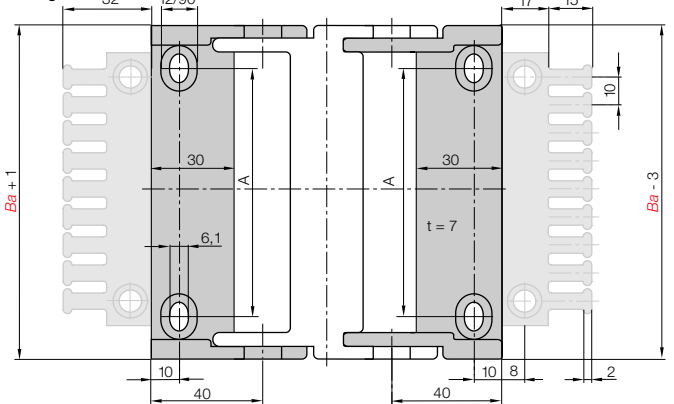

Standard! (pivoting) 2...4PZ(B)+

(locking) 2...2PZ(B)+

Fixed end

For E-Chain®	Part No. full set with tiwrap plate	Part No. with tiwrap plate + 10 cable tiwraps	Part No. full set without tiwrap plate	Dim. A [mm]
2400 - 2500.02 ▶	2020. <input type="checkbox"/> PZB+	2020. <input type="checkbox"/> PZBK1+	2020. <input type="checkbox"/> PZ+	12
2400 - 2500.03 ▶	2030. <input type="checkbox"/> PZB+	2030. <input type="checkbox"/> PZBK1+	2030. <input type="checkbox"/> PZ+	25
2400 - 2500.05 ▶	2050. <input type="checkbox"/> PZB+	2050. <input type="checkbox"/> PZBK1+	2050. <input type="checkbox"/> PZ+	44
2400 - 2500.07 ▶	2070. <input type="checkbox"/> PZB+	2070. <input type="checkbox"/> PZBK1+	2070. <input type="checkbox"/> PZ+	64
2400 - 2500.09 ▶	2090. <input type="checkbox"/> PZB+	2090. <input type="checkbox"/> PZBK1+	2090. <input type="checkbox"/> PZ+	77
2400 - 2500.10 ▶	2100. <input type="checkbox"/> PZB+	2100. <input type="checkbox"/> PZBK1+	2100. <input type="checkbox"/> PZ+	90
2400 - 2500.12 ▶	2125. <input type="checkbox"/> PZB+	2125. <input type="checkbox"/> PZBK1+	2125. <input type="checkbox"/> PZ+	112

Please add the Part No. with the requested index - 34 for the pivoting configuration

e.g. 2020. 34 PZB+ or 12 for the locking configuration e.g. 2020. 12 PZB+

For the preassembled mode please add the index A1...A4 e.g. 2020. 34 PZB+ A1



Steel mounting bracket - pivoting

- Pivoting connections
- One part for all chain widths
- Electrically conductive
- Bolted connection outside of chain cross-section possible

Moving end with bore
(outer link) 2000.3

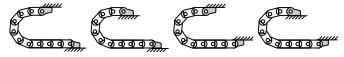
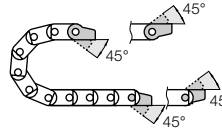

2000.2 Fixed end
with pin (inner link)

Possible installation conditions -
Further installation angles ► installation sketch

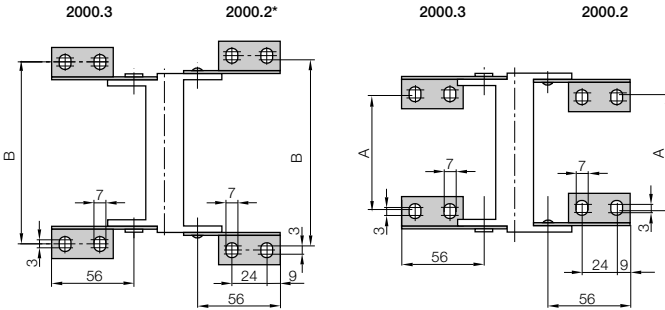

Dimensions and order configurations

*pivoting with no stop, (360°)

For E-Chain*	Part No. full set	Dim. A [mm]	Dim. B [mm]
2400 - 2500.02 ►	2000. [32]	-	60
2400 - 2500.03 ►	2000. [32]	25	73
2400 - 2500.05 ►	2000. [32]	44	92
2400 - 2500.07 ►	2000. [32]	64	112
2400 - 2500.09 ►	2000. [32]	76	124
2400 - 2500.10 ►	2000. [32]	90	138
2400 - 2500.12 ►	2000. [32]	112	160

2000. [32] Full set, 4 parts
2 with pin / 2 with bore

Single-part order:

- 2000. [3] Mounting bracket with bore, 1 part left / right
- 2000. [2] Mounting bracket with pin, 1 part left / right

Phone +49- (0) 22 03-96 49-800
Fax +49- (0) 22 03-96 49-222



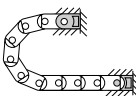

The attachment variants arising automatically by the choice of the KMA mounting bracket

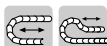

KMA = Polymer Metal Mounting Bracket

Option KMA, pivoting for E-Chains® Series 2400 and Series 2500

- Recommended for unsupported applications
- Bolted connection outside of chain cross-section
- Confined installation conditions
- Universal mountable with attachment capability on all sides
- Strain relief separator pluggable into the KMA-bracket, adjustable in 3 heights
- Stackable

Moving end with bore
Series 2400 = 24001...1
Series 2500 = 24001...1

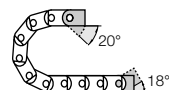

Series 2400 = 24001...2

Series 2500 = 24001...2

Fixed end with pin

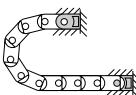

The attachment variants arising automatically by the choice of the KMA mounting bracket



KMA = Polymer Metal Mounting Bracket

Option KMA, locking for E-Chains® Series 2400 and Series 2500

- Recommended for vertical hanging / standing applications
- Bolted connection outside of chain cross-section
- At very high speed and acceleration
- Universal mountable with attachment capability on all sides
- Strain relief separator pluggable into the KMA-bracket, adjustable in 3 heights
- Stackable

Moving end with bore

Series 2400 = 24101...1

Series 2500 = 24101...1

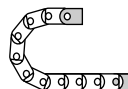

Series 2400 = 24101...2

Series 2500 = 24101...2

Fixed end with pin

Dimensions and order configurations

2400 | 2500 = 24001...1 (pivoting)

2400 | 2500 = 24001...2 (pivoting)

2400 | 2500 = 24101...1 (locking)

2400 | 2500 = 24101...2 (locking)

Moving end

Fixed end

Part No. structure (pivoting)

24001.02.12.A

A... must be indicated on preassembled configurations

Full set

Width KMA pivoting for the selected E-Chain® type

Full set, for both ends:

24001.02.12.12

Single-part order:

24001.02.1

Mounting bracket with bore

24001.02.2

Mounting bracket with pin

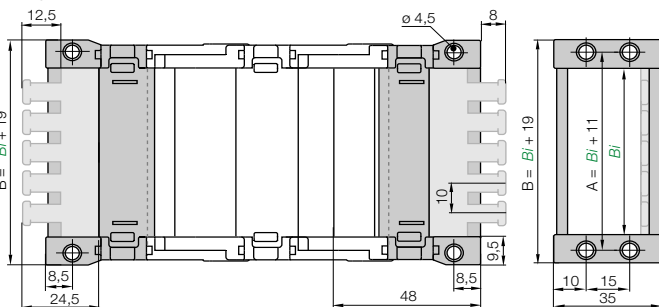

Part No. structure (locking)

24101.02.12.A

A... must be indicated on preassembled configurations

Full set

Width KMA locking for the selected E-Chain® type

Full set, for both ends:

24101.02.12

Single-part order:

24101.02.1

Mounting bracket with bore

24101.02.2

Mounting bracket with pin

For E-Chain®	Part No. full set with	Part No. full set without	Dim. A [mm]	Dim. B [mm]
Series 2400/2500	tiewrap plate			
2400.02 / 2500.02	24001.02.12.ZB	24001.02.12	36	44
2400.03 / 2500.03	24001.03.12.ZB	24001.03.12	49	57
2400.05 / 2500.05	24001.05.12.ZB	24001.05.12	68	76
2400.07 / 2500.07	24001.07.12.ZB	24001.07.12	88	86
2400.09 / 2500.09	24001.09.12.ZB	24001.09.12	100	108
2400.10 / 2500.10	24001.10.12.ZB	24001.10.12	114	122
2400.12 / 2500.12	24001.12.12.ZB	24001.12.12	136	144

● For E-Chains® please add the Part No. with the requested index

For the pivoting option e.g. 24001.02.12 or for the locking option e.g. 24101.02.12

For the preassembled mode please add the index A e.g. 24001.02.12 A

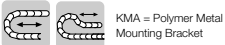

Option KMA, pivoting for half E-Tubes Series 2450 and for full E-Tubes Series 2480

- Recommended for unsupported applications
- Bolted connection outside of chain cross-section
- Confined installation conditions
- Universal mountable with attachment capability on all sides
- Strain relief separator pluggable into the KMA-bracket, adjustable in 3 heights
- Stackable

Moving end with bore
Series 2450 = 24501...1
Series 2480 = 24801...1

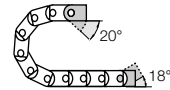

Series 2450 = 24501...2
Series 2480 = 24801...2
Fixed end with pin

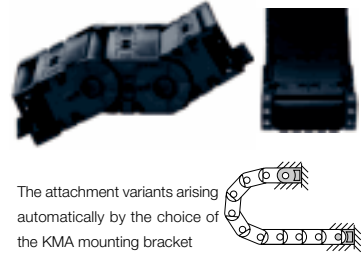

The attachment variants arising automatically by the choice of the KMA mounting bracket

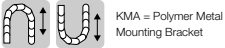

Option KMA, locking for half E-Tubes Series 2450 and for full E-Tubes Series 2480

- Recommended for vertical hanging / standing applications
- Bolted connection outside of chain cross-section
- At very high speed and acceleration
- Universal mountable with attachment capability on all sides
- Strain relief separator pluggable into the KMA-bracket, adjustable in 3 heights
- Stackable

Moving end with bore
Series 2450 = 24511...1
Series 2480 = 24811...1

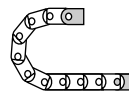

Series 2450 = 24511...2
Series 2480 = 24811...2
Fixed end with pin

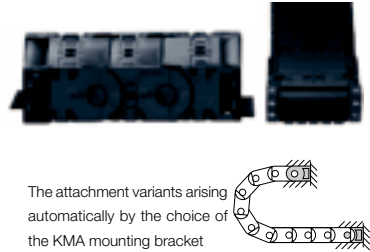

The attachment variants arising automatically by the choice of the KMA mounting bracket

2450 = 24501...1 | 2480 = 24801...1 (pivoting) 2450 = 24501...2 | 2480 = 24801...2 (pivoting)
2450 = 24511...1 | 2480 = 24811...1 (locking) 2450 = 24511...2 | 2480 = 24811...2 (locking)

Moving end

Fixed end

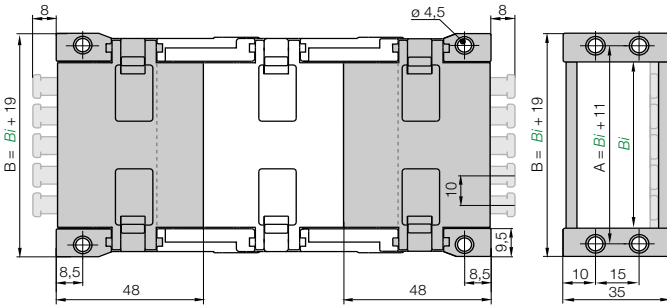

Dimensions and order configurations

Part No. structure (pivoting)

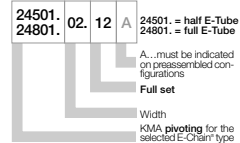

Full set, for both ends:

24501. / 24801. 02. 12

Single-part order:

24501. / 24801. 02. 1

Mounting bracket with bore

24501. / 24801. 02. 2

Mounting bracket with pin

Part No. structure (locking)

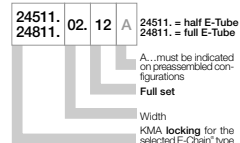

Full set, for both ends:

24511. / 24811. 02. 12

Single-part order:

24511. / 24811. 02. 1

Mounting bracket with bore

24511. / 24811. 02. 2

Mounting bracket with pin

For E-Chain*	Part No. full set with	Part No. full set without	Dim. A [mm]	Dim. B [mm]
Series 2400/2500	tiewrap plate	tiewrap plate		
2450.02 / 2480.02	02.12.ZB	02.12	36	44
2450.03 / 2480.03	03.12.ZB	03.12	49	57
2450.05 / 2480.05	05.12.ZB	05.12	68	76
2450.07 / 2480.07	07.12.ZB	07.12	88	96
2450.09 / 2480.09	09.12.ZB	09.12	100	108
2450.10 / 2480.10	10.12.ZB	10.12	114	122
2450.12 / 2480.12	12.12.ZB	12.12	136	144

- For **half E-Tube** please add the Part No. with the requested index
For the pivoting option e.g. 24501.02.12 or for the locking option e.g. 24511.02.12
For the **preassembled** mode please add the index [A] e.g. 24501.02.12[A]
- For **full E-Tube** please add the Part No. with the requested index
For the pivoting option e.g. 24801.02.12 or for the locking option e.g. 24811.02.12
For the **preassembled** mode please add the index [A] e.g. 24801.02.12[A]





Tie-strap plate as individual part

As individual component screwed on KMA. Can be plugged in the mounting brackets. **Details ▶ chapter 10**

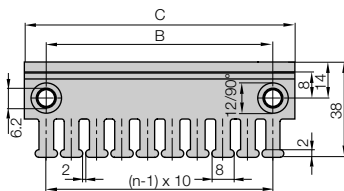
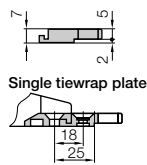

Tie-strap plate	No. of teeth n	Dim. C [mm]	Dim. B [mm]
2020.ZB	3	30	15
2030.ZB	4	40	20
2040.ZB	5	50	30
2050.ZB	6	60	40
2070.ZB	8	80	60
2090.ZB =			
(2030.ZB + 2040.ZB)	9	90	-
2100.ZB	10	100	80
2125.ZB =			
(2050.ZB + 2050.ZB)	12	120	-



Cable tie-strap as individual part

Cable tie-strap (100-piece bag)	Width x length	max. Ø	Tensile strength
CFB.001	4,8 x 150 mm	36 mm	222 N



"Double" strain relief

If an E-Chain® is harnessed with a very large number of cables, strain relief may be necessary at two levels. Our 2050.Z strain relief system was developed for this purpose. It can be placed in any position along the E-Chain®. As required, the 2050.Z strain relief system is simply clamped onto the crossbar of the chain link. No additional installation elements are needed. **Details ▶ chapter 10**

Part No.	Width strain relief [mm]	
2050.Z*	60	*not available for Series 2450/2480

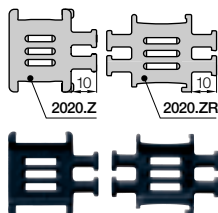

Strain relief separator

Separator with integrated strain relief, for use in the first or last chain link. For manufacturing of switchgear cabinets or for the assembly of machines. Easy to assemble without any fastening device. Separator base 2020.Z and 2020.ZR is 10 mm wide. The possible number of separators per E-Chain® is defined by its inner width *B_i* and by the cable-diameter. **Details ▶ chapter 10**

Part No.	Number of teeth	For Series
2020.Z	2 one side	2400/2500 E-Chain®
2020.ZR	2 both sides	2450/2480 E-Tube



Strain relief for steel mounting brackets

Clip-on connection is not possible with steel mounting brackets. In this case, the tie-strap plates must be bolted directly into separate bore holes in front of the mounting bracket. Alternatively the tie-strap plates 20XX.ZB can be also used here. **Details ▶ chapter 10**



Other strain relief elements - optional ▶ chapter 10

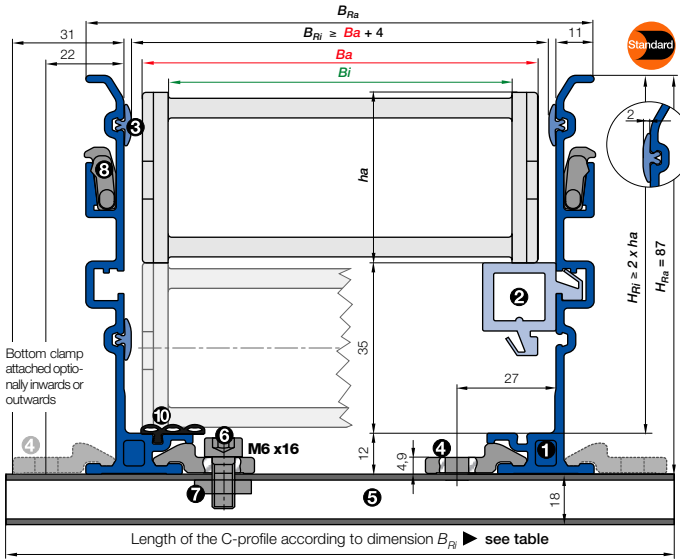

- B_a = Outer width E-Chains* / E-Tube
 - B_i = Inner width E-Chains* / E-Tube
 - h_a = Outer height E-Chains* / E-Tube
 - H_{Ri} = Inner trough height
 - H_{Ra} = Outer trough height
 - B_{Ri} = Inner trough width ► depends on dim. B_a
 - B_{Ra} = Outer trough width
 - n_{Mon} = Number of installation sets (left/right)
 - n_{Ri} = Number of trough sets (left/right)
- $H_{Ri} \geq 2 \cdot h_a$
 $B_{Ri} \geq B_a + 4$
- = Guide trough set
 - = Installation set "Basic"
 - = C-profile
 - = Glide bar
 - = C-profile

Installation set "Basic" with C-profile

Bottom Clamp attached optionally inwards or outwards

2500.05.200.0 ► Order example

B_{Ri} [mm]	Part No.	
	attached inwards	attached outwards
.02	45	960.30.150
.03	58	960.30.150
.05	77	960.30.125 960.30.175
.07	97	960.30.150 960.30.200
.09	109	960.30.175 960.30.225
.10	123	960.30.175 960.30.225
.12	145	960.30.200 960.30.250



- **Components, trough "Basic":** ① Trough side parts, aluminum, 2 m ② Glide bar, plastic, 2 m ③ Glide strips, plastic, 2 m (without glide strips on request) ⑩ Optional: Silencer profile, rubber
- **Components, installation set "Basic":** ④ Bottom clamp, aluminum ⑤ C-profile, steel galvanized ⑥ Screw M6 x16 ⑦ Sliding nut M6 ⑧ Interface connector, plastic

Order example: Length of travel 30 m - Center mounted for Series 2500.05.200.0 with $B_{Ri} = 77$

- Guide trough set (set of 2 trough side parts, incl. glide strips) **without** glide bar
Order text: 16 m guide trough without glide bar (8 x 2 m sections) Part No. 971.30.SL
- Guide trough set (set of 2 trough side parts, incl. glide strips) **with** glide bar
Order text: 16 m guide trough with glide bar (8 x 2 m sections) Part No. 971.31.SL
- Installation set "Basic" complete (guide trough-sets + 1)
Order text: 17 installation sets "Basic" Part No. 960.30.125
- Module for the fixed end
Order text: 1 set Part No. 971.80
- Option:** For an additional noise dampening with silencer profile, please add Index A - Example:
Part No. 971.30.SLA

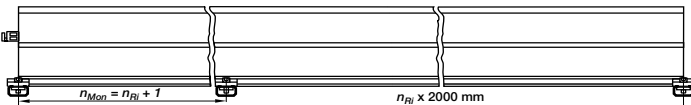

Principle sketch: Number of installation sets to be installed = **Number of trough sections + 1**



A quick fix for mounting the stationary end of an E-Chain*
 With this module for the fixed end, fast and easy mounting onto the Aluminum "SuperTrough" is now possible without any drilling. Fast mounting of the E-Chain* by clamping onto the aluminum trough

- Quick relocation of the stationary end
- No drilling necessary

Insert for the installation set "Heavy-Duty": **971.50.XXX** instead of **(960.30.XXX)** on the right column "attached outwards"

Phone +49- (0) 22 03-96 49-800
 Fax +49- (0) 22 03-96 49-222



► chapter 10



► chapter 9



► page 5.91

● ● ● Price index

IPA Qualification Certificate Air Cleanless Class ISO Class 3 (at v = 2 m/s) upon request

EX ESD classification: Electrically conductive ESD/ATEX version upon request

RU UL94 V2 classifications upon request



Snap-open mechanism, choice of snap-open on left or right. Hinged crossbar can be swiveled by more than 180° on both sides. Lightning-fast closing by hand. Secure fit without additional locking devices.



When to use the Series 2600/2650/2680/2700:

- Snap-open accessibility along both radii
- If integrated strain relief is required at the connection point
- Modular interior separation
- If long service life is required
- If easy installation is required
- If half E-Tube is required (Series 2650)
- If fully enclosed E-Tube is required (Series 2680)



When not to use it:

- If maximum stability is required
 - ▶ System E4.1, Series E4.32, page 7.34
- If the application is very simple
 - ▶ Easy Chain®, Series E26, page 3.46
- E-Tubes with small bending radii 075
 - ▶ E2 E-Tubes, Series R58, page 6.34

- ① Opening system for rapid opening, either from the right or the left
- ② Double stop dog for long unsupported length
- ③ Cross bars with high locking range
- ④ Lateral glide surfaces for side-mounted operation
- ⑤ Tried-and-tested mounting bracket
- ⑥ Integrated strain relief possible
- ⑦ Half E-Tube Series 2650
- ⑧ Series 2600 and 2650 snap-open along inner radius
- ⑨ Fully enclosed E-Tube Series 2680
- ⑩ Modular interior separation
- ⑪ Easy assembly by optimized pin
- ⑫ Also available as ESD version
- ⑬ **Strain relief separator** - Separator with integrated strain relief ▶ page 5.124

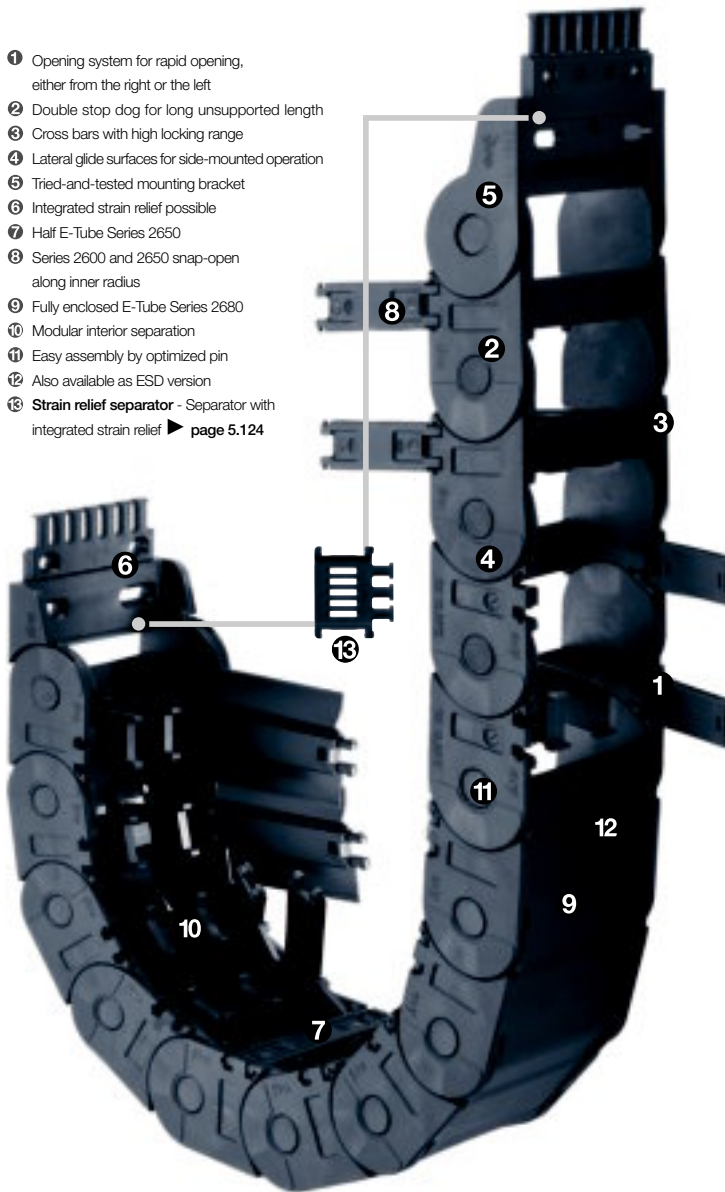

 Order example complete E-Chain®

Please indicate chain-lengths or number of links Example: 3 m or 54 links

3 m 2700.10.100.0

 E-Chain®

with 2 separators 261 assembled every 2nd link

 Interior separation

1 set 2610.34PZB

 Mounting bracket



Unsupported length

FL_G = with straight upper run

FL_B = with permitted sag

Further information ► **Design, page 1.12**

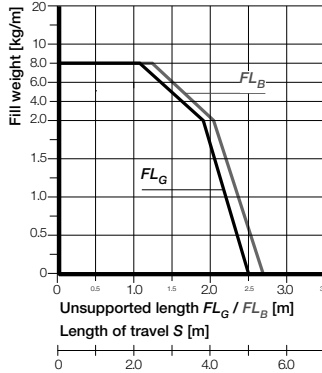
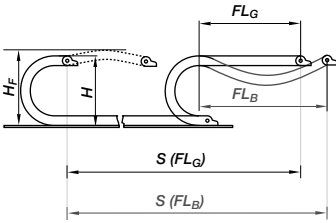

- S = Length of travel
 - R = Bending radius
 - H = Nominal clearance height
 - H_F = Required clearance height
 - H_{RI} = Trough inner height
 - D = Overlength E-Chain® radius in final position
 - $K = \pi \cdot R + \text{"safety"}$
 - D_2 = Over length - long travels, gliding
 - K_2 = "Further add-on"
 - H_2 = "Mounting height"
- *if the mounting bracket location is set lower

Other installation methods

- Vertical, hanging ≤ 50 m
- Vertical, standing ≤ 3 m
- Side mounted, un supp. ≤ 1 m
- Rotary requires further calculation
- Unsupported length of upper run = upon request

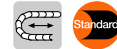

Short travels - unsupported

Unsupported E-Chains® feature positive camber over short travels. This must be accounted for when specifying the clearance height H_F . Please consult igus® if space is particularly restricted.

The required clearance height:

$$H_F = H + 35 \text{ mm}$$

(with 2,0 kg/m fill weight)

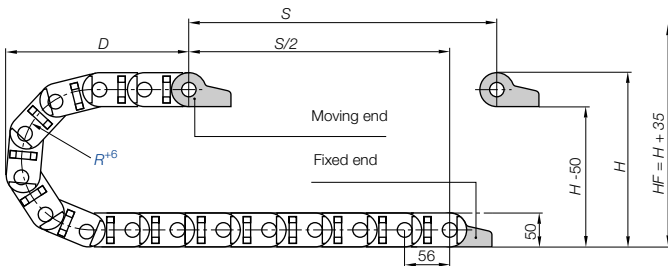

Pitch = 56 mm/link Links/m = 18 (1008 mm) Chain length = $S/2 + K$

	063*	075*	100	125	150	175	200	250
H	180	200	250	300	350	400	450	550
D	140	150	175	200	225	250	275	325
K	335	375	475	550	650	750	825	925
H_2	180	200	166	166	166	166	166	166
D_2^{*25}	140	150	350	475	500	655	770	950
K_2	335	375	616	784	896	1120	1288	1624

*for Series 2650/2680 upon request

Long travel lengths from 10 m to max. 120 m Chain length = $S/2 + K_2$

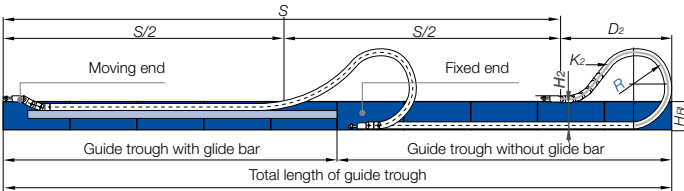

In case of travels between 4 and 10 m we recommend a longer unsupported length.



Gliding, long travel applications (max. 120 m)

In this case the E-Chain® upper run will be introduced in a guide trough on the lower run. We recommend to realize the engineering of such a plant by our technicians.

Technical Data

Speed / acceleration FL_G	max. 20 [m/s] / max. 200 [m/s ²]
Speed / acceleration FL_B	max. 3 [m/s] / max. 6 [m/s ²]
Gliding speed / acceleration (maximum)	max. 10 [m/s] / max. 50 [m/s ²]
Material - permitted temperature °C	igumid G / -40° up to +120° C
Flammability class, igumid G	VDE 0304 IIC UL94 HB



Details of material properties
► page 1.38

For support of the lower run - **Support Tray tool kit** available ► page 9.70

E2/000 medium
Inner height: 35 mm

Phone +49- (0) 22 03-96 49-800
Fax +49- (0) 22 03-96 49-222



► page 5.91

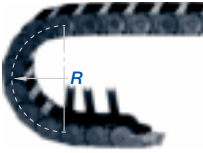
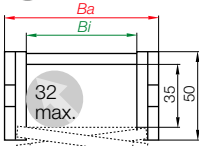

Series 2600 - E-Chain® - snap-open along inner radius

Part No.	Bi [mm]	Ba [mm]	R [mm]	Bending radii								Weight [kg/m]
2600.05.□.0	50	66	063	075	100	125	150	175	200	250	~ 1,17	
2600.06.□.0	65	81	063	075	100	125	150	175	200	250	~ 1,24	
2600.07.□.0	75	91	063	075	100	125	150	175	200	250	~ 1,30	
2600.09.□.0	90	106	063	075	100	125	150	175	200	250	~ 1,37	
2600.10.□.0	100	116	063	075	100	125	150	175	200	250	~ 1,39	
2600.12.□.0	125	141	063	075	100	125	150	175	200	250	~ 1,48	
2600.15.□.0	150	166	063	075	100	125	150	175	200	250	~ 1,62	
2600.17.□.0	175	194	063	075	100	125	150	175	200	250	~ 1,85	

Part No. structure

2600. 05. 063. 0



Supplement Part No. with required radius. Example: 2600.05.063.0

0 = standard color, other colors ▶ page 1.39 · Pitch = 56 mm/link - Links/m = 18



Please note: For using this series for long travels (gliding), please consult with igus® first. For long travels, igus® specifies E-Chains® that snap open on the outer radius.

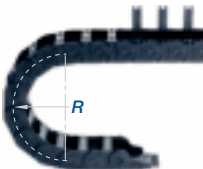
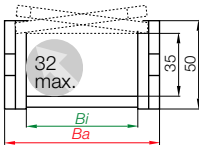

Series 2700 - E-Chain® - snap-open along outer radius - Standard!

Part No.	Bi [mm]	Ba [mm]	R [mm]	Bending radii								Weight [kg/m]
2700.05.□.0	50	66	063	075	100	125	150	175	200	250	~ 1,17	
2700.06.□.0	65	81	063	075	100	125	150	175	200	250	~ 1,24	
2700.07.□.0	75	91	063	075	100	125	150	175	200	250	~ 1,30	
2700.09.□.0	90	106	063	075	100	125	150	175	200	250	~ 1,37	
2700.10.□.0	100	116	063	075	100	125	150	175	200	250	~ 1,39	
2700.12.□.0	125	141	063	075	100	125	150	175	200	250	~ 1,48	
2700.15.□.0	150	166	063	075	100	125	150	175	200	250	~ 1,62	
2700.17.□.0	175	194	063	075	100	125	150	175	200	250	~ 1,85	

Part No. structure

2700. 05. 063. 0



Supplement Part No. with required radius. Example: 2700.05.063.0

0 = standard color, other colors ▶ page 1.39 · Pitch = 56 mm/link - Links/m = 18



Series 2650 - half E-Tube - snap-open along inner radius

Part No.	B _i [mm]	B _a [mm]	R [mm]	Bending radii	Weight [kg/m]
2650.05.□.0	50	66	100	125 150 175 200 250	≈ 1,25
2650.06.□.0	65	81	100	125 150 175 200 250	≈ 1,36
2650.07.□.0	75	91	100	125 150 175 200 250	≈ 1,40
2650.09.□.0	90	106	100	125 150 175 200 250	≈ 1,55
2650.10.□.0	100	116	100	125 150 175 200 250	≈ 1,61
2650.12.□.0	125	141	100	125 150 175 200 250	≈ 1,70
2650.15.□.0	150	166	100	125 150 175 200 250	≈ 1,80
2650.17.□.0	175	194	100	125 150 175 200 250	≈ 2,00

The widths **B_i 90/150/175** are available upon request. Time of delivery approx. 6-8 weeks after order.
The bending radii **063 | 075** are available upon request.

Supplement Part No. with required radius. Example: 2650.05.100.0

0 = standard color, other colors ▶ page 1.39 · Pitch = 56 mm/link · Links/m = 18



Please note: For using this series for long travels (gliding), please consult with igus® first. For long travels, igus® specifies E-Chains® that snap open on the outer radius.

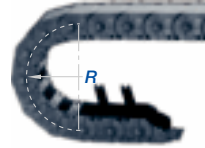
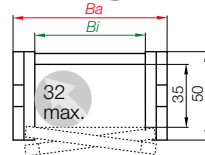

Part No. structure

2650. 05. 100. 0



E2/000 medium
Inner height: 35 mm

Series 2680 - E-Tube - snap-open along inner radius

Part No.	B _i [mm]	B _a [mm]	R [mm]	Bending radii	Weight [kg/m]
2680.05.□.0	50	66	100	125 150 175 200 250	≈ 1,33
2680.06.□.0	65	81	100	125 150 175 200 250	≈ 1,43
2680.07.□.0	75	91	100	125 150 175 200 250	≈ 1,51
2680.09.□.0	90	106	100	125 150 175 200 250	≈ 1,62
2680.10.□.0	100	116	100	125 150 175 200 250	≈ 1,81
2680.12.□.0	125	141	100	125 150 175 200 250	≈ 1,99
2680.15.□.0	150	166	100	125 150 175 200 250	≈ 2,17
2680.17.□.0	175	194	100	125 150 175 200 250	≈ 2,35

The widths **B_i 65/90/150/175** are available upon request. Time of delivery approx. 6-8 weeks after order.
The bending radii **063 | 075** are available upon request.

Supplement Part No. with required radius. Example: 2680.07.100.0

0 = standard color, other colors ▶ page 1.39 · Pitch = 56 mm/link · Links/m = 18



Please note: For using this series for long travels (gliding), please consult with igus® first. For long travels, igus® specifies E-Chains® that snap open on the outer radius.

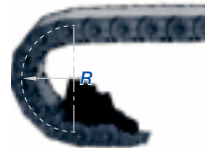
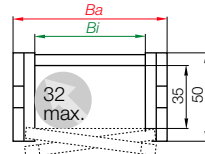

Part No. structure

2680. 07. 100. 0



For smaller bending radii we recommend the fully closed E-Tubes, Series R58 ▶ page 6.34

Phone +49- (0) 22 03-96 49-800
Fax +49- (0) 22 03-96 49-222



▶ page 5.91



Vertical Separator	
unassembled	260
assembled	261



Vertical Separator*	
unassembled	260.24
assembled	261.24



Spacer*	
unassembled	205.09
assembled	215.09



Strain Relief Separator	
unassembled	262.Z
assembled	263.Z



*For side-mounted applications

Option 1: Vertical Separators and Spacer for E-Chains®

Vertical Separators are used if a vertical subdivision of the E-Chain® interior is required -

By standard Vertical Separators are assembled every other E-Chain® link

- **Standard** subdivision (Series 2600/Series 2700) with Vertical Separator 261, for combinations with Full-Width Shelf 221.X
- If a broad distance shall be kept between the separators or they have to be fixed in their position, e.g. in case of side mounted applications, separators **with wide base 261.24** or **Spacer 215.09** can be used
- **Strain Relief Separator 262.Z**, integrable in the mounting bracket, to position at any point

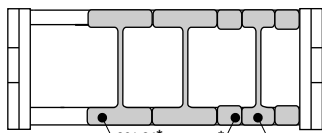

Vert. Separator, slotted	
unassembled	268
assembled	269



Option 2: Full-Width Shelves for E-Chains®

For applications involving many thin cables with similar or identical diameters

- **Vertical Separator, slotted 269** - for applications with Full-Width Shelf 221.X

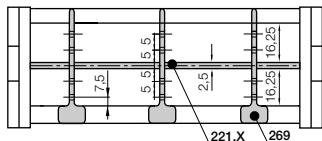

Full-Width Shelf	
X-1	
t = 2,5	

Middle Plate	
unassembled	262
assembled	263



Slotted Separator	
unassembled	266
assembled	267



Slotted Separator, open	
unassembled	276
assembled	277



Side Plate	
unassembled	264
assembled	265



Shelf	
X	
X - 7	
t = 2,5	

Option 3: Shelves for E-Chains®

For applications involving many cables with different diameters. The Shelves can be arranged elevator-shifted with different bottoms within the entire E-Chain® width

- Shelf 2210.X can be combined with Middle Plate 263, Slotted Separator 267 and Side Plate 265
- Option 3 "Shelves" can also be combined with option 1 "Vertical Separators"
- Assembling of the **Slotted Separator, open 277** in the existing separation afterwards possible

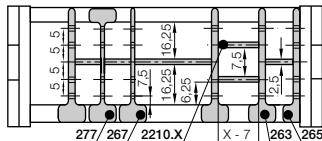

Width X [mm]	Part No. unassembled	Part No. assembled
018	2200.18	2210.18
023	2200.23	2210.23
028	2200.28	2210.28
033	2200.33	2210.33
038	2200.38	2210.38
043	2200.43	2210.43
048	2200.48	2210.48

Width X [mm]	Part No. unassembled	Part No. assembled
058	2200.58	2210.58
068	2200.68	2210.68
073	2200.73	2210.73
088	2200.88	2210.88
099	2200.99	2210.99
124	2200.124	2210.124
149	2200.149	2210.149

Option 4: Vertical Separators for E-Tubes

Vertical Separators are used if a vertical subdivision of the E-Tube interior is required -

By standard Vertical Separators are assembled every other E-Tube link

- **Standard** subdivision of the half E-Tube (**Series 2650**) and the fully enclosed E-Tube (**Series 2680**) with **Vertical Separator, slotted 26511**, for combinations with **Full-Width Shelf 221.X**

Vert. Separator, slotted		
unassembled	26501	
assembled	26511	

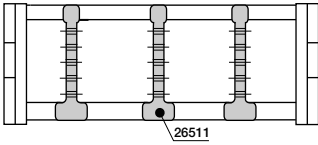

E2 medium
Inner height: 35 mm

Option 5: Full-Width Shelves for E-Tubes

For applications involving many thin cables with similar or identical diameters

- **Vertical Separator, slotted 26511** - for applications with **Full-Width Shelf 221.X**

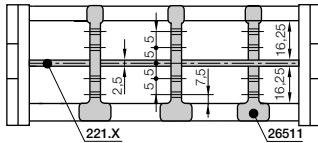

Width X [mm]	Part No. unassembled	Part No. assembled
050	220.50	221.50
065	220.65	221.65
075	220.75	221.75
090	220.90	221.90

Width X [mm]	Part No. unassembled	Part No. assembled
100	220.100	221.100
125	220.125	221.125
150	220.150	221.150
175	220.175	221.175

Full-Width Shelf
X - 1
t = 2,5

Phone +49- (0) 22 03-96 49-800
Fax +49- (0) 22 03-96 49-222

Variante 6 - Shelves for E-Tubes

For applications involving many cables with different diameters. The Shelves can be arranged elevator-shifted with different bottoms within the entire E-Chain® width

- **Shelf 2210.X** can be combined with **Vertical Separator, slotted 26511**
- Assembling of the **Slotted Separator, open 277** in the existing separation afterwards possible

Slotted Separator, open		
unassembled	276	
assembled	277	

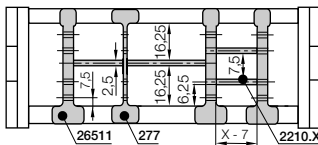

Width X [mm]	Part No. unassembled	Part No. assembled
018	2200.18	2210.18
023	2200.23	2210.23
028	2200.28	2210.28
033	2200.33	2210.33
038	2200.38	2210.38
043	2200.43	2210.43
048	2200.48	2210.48

Width X [mm]	Part No. unassembled	Part No. assembled
058	2200.58	2210.58
068	2200.68	2210.68
073	2200.73	2210.73
088	2200.88	2210.88
099	2200.99	2210.99
124	2200.124	2210.124
149	2200.149	2210.149

Shelf
X
X - 7
t = 2,5



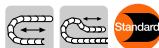

The Standard - option polymer - pivoting

- Recommended for unsupported and gliding applications
- Well suited for tight installation conditions
- Strain relief with detachable tiewrap plates
- Variable traverse angle for flexible assembly
- The twistability of the E-Chain® and the option to assemble the mounting brackets on the fixed end and/or the moving end, enable various installation options

Moving end with bore
(outer link) 26...3PZ(B)

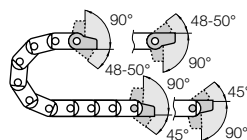

26...4PZ(B) Fixed end
with pin (inner link)



Possible installation conditions for assembled mounting brackets ▶ Order example "preassembled" below

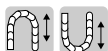

Option polymer - locking

- Recommended for unsupported and gliding applications
- At very high speed and/or acceleration
- If space is limited for height (the H_F measurement)
- The twistability of the E-Chain® and the option to assemble the mounting brackets on the fixed end and/or the moving end, enable various installation options

Moving end with bore
(outer link) 26...1PZ(B)

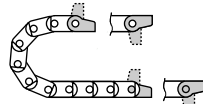

26...2PZ(B) Fixed end
with pin (inner link)



Possible installation conditions for assembled mounting brackets ▶ Order example "preassembled" below

Dimensions and order configurations

Strain relief is possible on the moving end and/or the fixed end.

Part No. structure (pivoting)

2605. 34 PZB A1

A... must be indicated on preassembled configurations
With assembled strain relief tiewrap plates
Full set pivoting = 34
Mounting brackets for selected chain type

Full set, for both ends:

2605. 34 PZB +tiewrap plate

Single-part order:

2605. 3 PZB +tiewrap plate

Mounting bracket with bore

2605. 4 PZB +tiewrap plate

Mounting bracket with pin

Part No. structure (locking)

2605. 12 PZB A1

A... must be indicated on preassembled configurations
With assembled strain relief tiewrap plates
Full set locking = 12
Mounting brackets for selected chain type

Full set, for both ends:

2605. 12 PZB +tiewrap plate

Single-part order:

2605. 1 PZB +tiewrap plate

Mounting bracket with bore

2605. 2 PZB +tiewrap plate

Mounting bracket with pin

26...3PZ(B) Standard! (pivoting)

26...1PZ(B) (locking)

Moving end

Standard! (pivoting) 26...4PZ(B)

(locking) 26...2PZ(B)

Fixed end

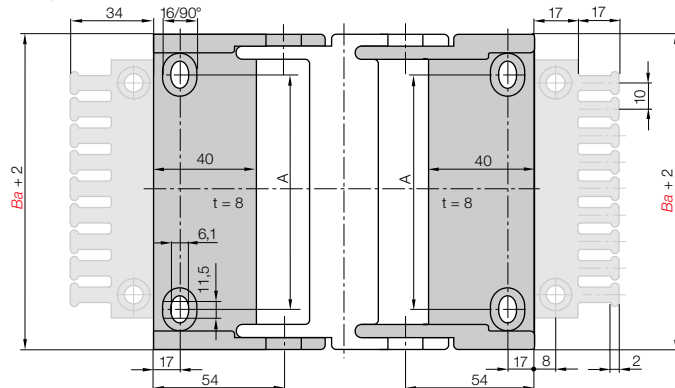

For E-Chain®	Part No. full set with tiewrap plate	Part No. with tiewrap plate + 10 cable tiewraps	Part No. full set without tiewrap plate	Dim. A [mm]
2600 - 2700.05 ▶	2605. <input type="checkbox"/> PZB	2605. <input type="checkbox"/> PZBK1	2605. <input type="checkbox"/> PZ	30
2600 - 2700.06 ▶	2606. <input type="checkbox"/> PZB	2606. <input type="checkbox"/> PZBK1	2606. <input type="checkbox"/> PZ	45
2600 - 2700.07 ▶	2607. <input type="checkbox"/> PZB	2607. <input type="checkbox"/> PZBK1	2607. <input type="checkbox"/> PZ	55
2600 - 2700.09 ▶	2609. <input type="checkbox"/> PZB	2609. <input type="checkbox"/> PZBK1	2609. <input type="checkbox"/> PZ	70
2600 - 2700.10 ▶	2610. <input type="checkbox"/> PZB	2610. <input type="checkbox"/> PZBK1	2610. <input type="checkbox"/> PZ	80
2600 - 2700.12 ▶	2612. <input type="checkbox"/> PZB	2612. <input type="checkbox"/> PZBK1	2612. <input type="checkbox"/> PZ	105
2600 - 2700.15 ▶	2615. <input type="checkbox"/> PZB	2615. <input type="checkbox"/> PZBK1	2615. <input type="checkbox"/> PZ	130
2600 - 2700.17 ▶	2617. <input type="checkbox"/> PZB	2617. <input type="checkbox"/> PZBK1	2617. <input type="checkbox"/> PZ	155

Please add the Part No. with the requested index - 34 for the pivoting configuration

e.g. 2605. 34 PZB or 12 for the locking configuration e.g. 2605. 12 PZB

For the preassembled mode please add the index A1...A4 e.g. 2605. 34 PZB A1



Steel mounting bracket - locking

- Locked connections
- One part for all chain widths
- Electrically conductive
- Bolted connection outside of chain cross-section possible

Moving end with bore
(outer link) 260.1

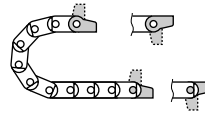

260.2 Fixed end
with pin (inner link)

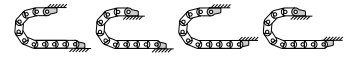

Possible installation conditions -
Further installation angles ► installation sketch

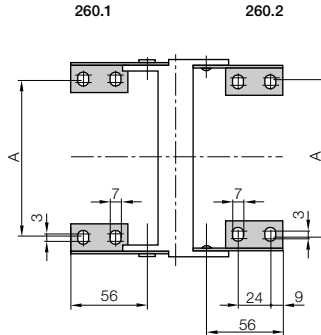
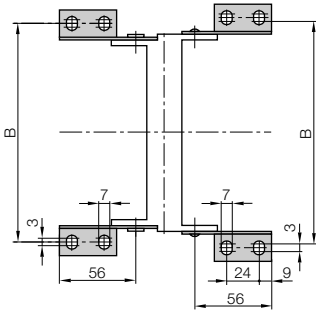

Dimensions and order configurations

*pivoting with no stop, (360°)

For E-Chain*	Part No. full set	Dim. A [mm]	Dim. B [mm]
2600 - 2700.05 ►	260. 12	37	83
2600 - 2700.06 ►	260. 12	52	98
2600 - 2700.07 ►	260. 12	62	108
2600 - 2700.09 ►	260. 12	77	123
2600 - 2700.10 ►	260. 12	87	133
2600 - 2700.12 ►	260. 12	112	158
2600 - 2700.15 ►	260. 12	137	183
2600 - 2700.17 ►	260. 12	163	209

260. 12 Full set, 4 parts
2 with pin / 2 with bore

Single-part order:

260. 1 Mounting bracket
with bore, 1 part left / right

260. 2 Mounting bracket with
pin, 1 part left / right

Phone +49- (0) 22 03-96 49-800
Fax +49- (0) 22 03-96 49-222



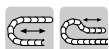

Option KMA, pivoting for E-Chains®
Series 2600 and Series 2700

- Recommended for unsupported applications
- Bolted connection outside of chain cross-section
- Confined installation conditions
- Universal mountable with attachment capability on all sides
- Stackable

Moving end with bore
Series 2600 = 26001...1
Series 2700 = 26001...1

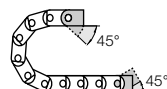

Series 2600 = 26001...2
Series 2700 = 26001...2

Fixed end with pin

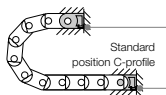

The attachment variants arising automatically by the choice of the KMA mounting bracket

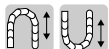

KMA = Polymer Metal Mounting Bracket

Option KMA, locking for E-Chains®
Series 2600 and Series 2700

- Recommended for vertical hanging / standing applications
- Bolted connection outside of chain cross-section
- At very high speed and acceleration
- Universal mountable with attachment capability on all sides
- Stackable

Moving end with bore

Series 2600 = 26101...1
Series 2700 = 26101...1

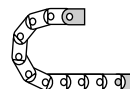

Series 2600 = 26101...2
Series 2700 = 26101...2

Fixed end with pin

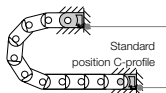

The attachment variants arising automatically by the choice of the KMA mounting bracket

Dimensions and order configurations

Part No. structure (pivoting)

26001.05.12.C.A

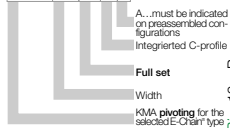

Full set, for both ends:

26001.05.12.C (with C-profile)

Single-part order:

26001.05.1.C (with C-profile)

Mounting bracket with bore

26001.05.2.C (with C-profile)

Mounting bracket with pin

2600 | 2700 = 26001...1 (pivoting)

2600 | 2700 = 26101...1 (locking)

Moving end

2600 | 2700 = 26001...2 (pivoting)

2600 | 2700 = 26101...2 (locking)

Fixed end

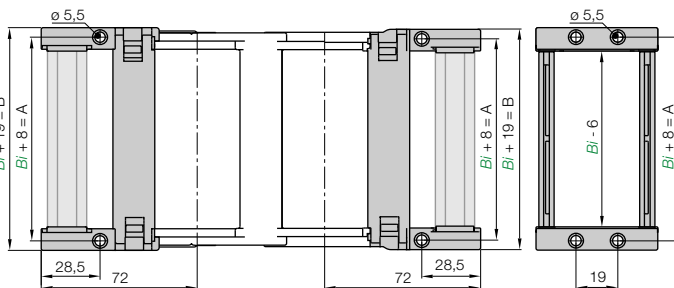

For E-Chain®	Part No. full set	Part No. full set	Dim. A [mm]	Dim B [mm]
Series 2600/2700	with C-profile	without C-profile		
2600/2700.05	26001.05.12.C	26001.05.12	58	69
2600/2700.06	26001.05.12.C	26001.06.12	73	84
2600/2700.07	26001.05.12.C	26001.07.12	83	94
2600/2700.09	26001.05.12.C	26001.09.12	98	109
2600/2700.10	26001.05.12.C	26001.10.12	108	119
2600/2700.12	26001.05.12.C	26001.12.12	133	144
2600/2700.15	26001.05.12.C	26001.15.12	158	169
2600/2700.17	26001.05.12.C	26001.17.12	183	194

● For **E-Chains®** please add the Part No. with the requested index

For the pivoting option e.g. 26001.05.12 or for the locking option e.g. 26101.05.12

For the **preassembled** mode please add the index [A] e.g. 26101.05.12 [A]

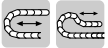

KMA = Polymer Metal Mounting Bracket

Option KMA, pivoting for half E-Tubes Series 2650 and for full E-Tubes Series 2680

- Recommended for unsupported applications
- Bolted connection outside of chain cross-section
- Confined installation conditions
- Universal mountable with attachment capability on all sides
- Stackable

Moving end with bore
Series 2650 = 26500...1
Series 2680 = 26800...1

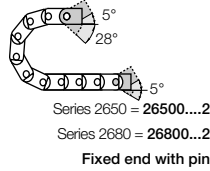

The attachment variants arising automatically by the choice of the KMA mounting bracket

Standard position C-profile

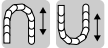

KMA = Kunststoff-Metall-Anschlussleimant

Option KMA, locking for half E-Tubes Series 2650 and for full E-Tubes Series 2680

- Recommended for vertical hanging / standing applications
- Bolted connection outside of chain cross-section
- At very high speed and acceleration
- Universal mountable with attachment capability on all sides
- Stackable

Moving end with bore
Series 2650 = 26510...1
Series 2680 = 26810...1

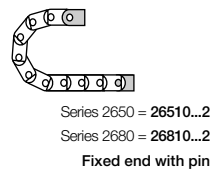

The attachment variants arising automatically by the choice of the KMA mounting bracket

Standard position C-profile

2650 = 26500...1 | 2680 = 26800...1 (pivoting) 2650 = 26500...2 | 2680 = 26800...2 (pivoting)
2650 = 26510...1 | 2680 = 26810...1 (locking) 2650 = 26510...2 | 2680 = 26810...2 (locking)

Moving end

Fixed end

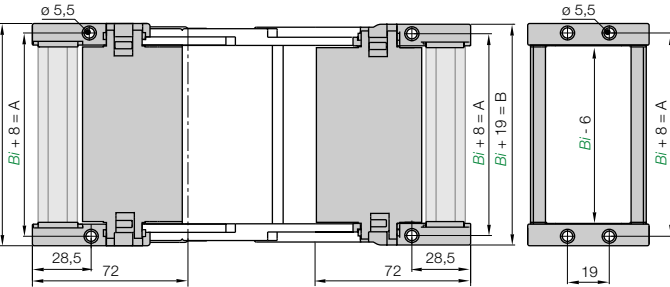

Maße und Bestellvarianten

Part No. structure (pivoting)

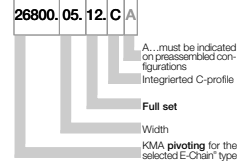

Full set, for both ends:
26800.05.12.C (with C-profile)

Single-part order:
26800.05.1.1.C (inkl. C-Profil)
Mounting bracket with bore
26800.05.1.2.C (inkl. C-Profil)
Mounting bracket with pin

Part No. structure (locking)

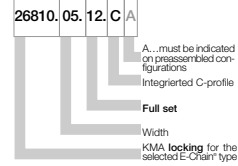

Full set, for both ends:
26810.05.12.C (with C-profile)

Single-part order:
26810.05.1.1.C (with C-profile)
Mounting bracket with bore
26810.05.1.2.C (with C-profile)
Mounting bracket with pin

For E-Chain*	Part No. full set	Part No. full set	Dim. A [mm]	Dim B [mm]
	with C-profile	without C-profile		
Series 2650/2680				
2650/2680.05	26500.05.12.C	26500.05.12	58	69
2650/2680.06	26500.06.12.C	26500.06.12	73	84
2650/2680.07	26500.07.12.C	26500.07.12	83	94
2650/2680.09	26500.09.12.C	26500.09.12	98	109
2650/2680.10	26500.10.12.C	26500.10.12	108	119
2650/2680.12	26500.12.12.C	26500.12.12	133	144
2650/2680.15	26500.15.12.C	26500.15.12	158	169
2650/2680.17	26500.17.12.C	26500.17.12	183	194

- For **half E-Tube** please add the Part No. with the requested index
For the pivoting option e.g. 26500.05.12 or for the locking option e.g. 26510.05.12
For the **preassembled** mode please add the index [A] e.g. 26510.05.12 [A]
- For **full E-Tube** please add the Part No. with the requested index
For the pivoting option e.g. 26800.05.12 or for the locking option e.g. 26810.05.12
For the **preassembled** mode please add the index [A] e.g. 26810.05.12 [A]



igus® E-ChainSystems®



Tiewrap plate as individual part

As individual component screwed on KMA. Can be plugged in the mounting brackets. **Details ▶ chapter 10**

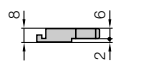

Single tie-strap plate

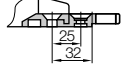

Shown assembled

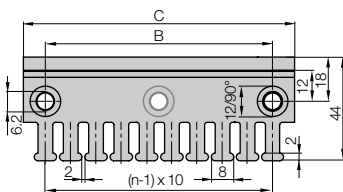

Tiewrap plate	No. of teeth <i>n</i>	Dim. C [mm]	Dim. B [mm]
3050.ZB	5	50	30
3075.ZB	7	75	55
3100.ZB	10	100	80
3115.ZB	11	115	95
3125.ZB	12	125	105
3150.ZB	15	150	130
3175.ZB	17	175	155
3200.ZB	20	200	180
3225.ZB	22	225	205
3250.ZB	25	250	230

(- = no / + = yes)

Phone +49- (0) 22 03-96 49-800
Fax +49- (0) 22 03-96 49-222



Cable tiewraps as individual part

Cable tiewraps (100-piece bag)	Width x length	max. Ø	Tensile strength
CFB.001	4,8 x 150 mm	36 mm	222 N



"Double" strain relief

If an E-Chain® is harnessed with a very large number of cables, strain relief may be necessary at two levels. Our 2050.Z strain relief system was developed for this purpose. It can be placed in any position along the E-Chain®. As required, the 2050.Z strain relief system is simply clamped onto the crossbar of the chain link. No additional installation elements are needed. **Details ▶ chapter 10**

Part No.	Width strain relief [mm]	
2050.Z*	60	*not available for Series 2650/2680

igus® GmbH
51147 Cologne

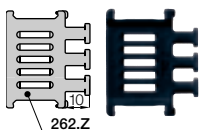

Strain relief separator

Separator with integrated strain relief, for use in the first or last chain link. For manufacturing of switchgear cabinets or for the assembly of machines. Easy to assemble without any fastening device. Separator base 262.Z is 10 mm wide. The possible number of separators per E-Chain® is defined by its inner width *B_i* and by the cable-diameter. **Details ▶ chapter 10**

Part No.	Number of teeth	For Series
262.Z	3 one side	2600/2700 E-Chain®



Strain relief for steel mounting brackets

Clip-on connection is not possible with steel mounting brackets. In this case, the tie-strap plates must be bolted directly into separate bore holes in front of the mounting bracket. Alternatively the tie-strap plates 30XX.Z and ZS can be also used here. **Details ▶ chapter 10**

Internet: www.igus.eu
E-mail: info@igus.de

Chainfix strain relief C-profile-solutions - more Details ▶ chapter 10



Other strain relief elements - optional ▶ chapter 10



Chainfix clamps made of steel or stainless steel



Chainfix Clips - modular, snap-on



Chainfix Nugget with pre-harnessed cable strap



Chainfix - tie-strap plates with clip-on connection

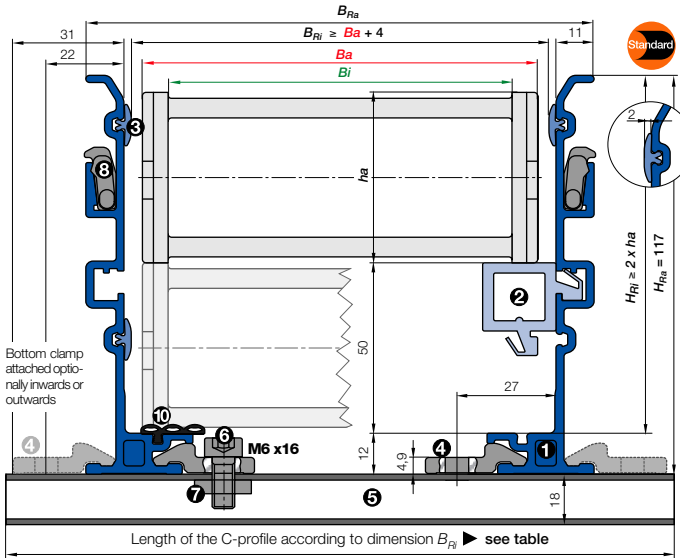

- B_a = Outer width E-Chains* / E-Tube
 - B_i = Inner width E-Chains* / E-Tube
 - h_a = Outer height E-Chains* / E-Tube
 - H_{Ri} = Inner trough height
 - H_{Ra} = Outer trough height
 - B_{Ri} = Inner trough width ► depends on dim. B_a
 - B_{Ra} = Outer trough width
 - n_{Mon} = Number of installation sets (left/right)
 - n_{Ri} = Number of trough sets (left/right)
- $H_{Ri} \geq 2 \cdot h_a$
 $B_{Ri} \geq B_a + 4$
- = Guide trough set ● = Glide bar
 - = Installation set "Basic" ● = C-Profile

Installation set "Basic" with C-Profile

Bottom Clamp attached optionally inwards or outwards

2700.05.200.0 ► Order example

B_{Ri} [mm]	Part No.	
	attached inwards	attached outwards
.05	70	960.30.175
.06	85	960.30.150 960.30.200
.07	95	960.30.150 960.30.200
.09	110	960.30.175 960.30.225
.10	120	960.30.175 960.30.225
.12	145	960.30.200 960.30.250
.15	170	960.30.225 960.30.275
.17	198	960.30.250 960.30.300



- **Components, trough "Basic":** ① Trough side parts, aluminum, 2 m ② Glide bar, plastic, 2 m ③ Glide strips, plastic, 2 m (without glide strips on request) ⑩ Optional: Silencer profile, rubber
- **Components, installation set "Basic":** ④ Bottom clamp, aluminum ⑤ C-profile, steel galvanized ⑥ Screw M6 x16 ⑦ Sliding nut M6 ⑧ Interface connector, plastic

Order example: Length of travel 30 m - Center mounted for Series 2700.06.200.0 with $B_{Ri} = 85$

- Guide trough set (set of 2 trough side parts, incl. glide strips) **without** glide bar
Order text: 16 m guide trough without glide bar (8 x 2 m sections) Part No. 972.30.SL
- Guide trough set (set of 2 trough side parts, incl. glide strips) **with** glide bar
Order text: 16 m guide trough with glide bar (8 x 2 m sections) Part No. 972.32.SL
- Installation set "Basic" complete (guide trough-sets + 1)
Order text: 17 installation sets "Basic" Part No. 960.30.150
- Module for the fixed end
Order text: 1 set Part No. 972.81
- Option:** For an additional noise dampening with silencer profile, please add Index A - Example:
Part No. 972.30.SLA

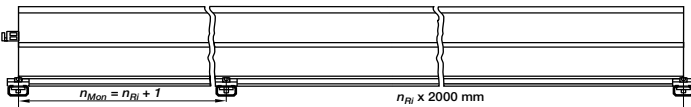

Principle sketch: Number of installation sets to be installed = **Number of trough sections + 1**

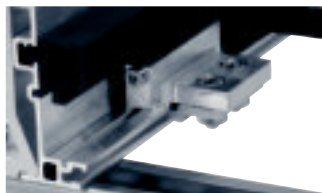

A quick fix for mounting the stationary end of an E-Chain*

With this module for the fixed end, fast and easy mounting onto the Aluminum "SuperTrough" is now possible without any drilling. Fast mounting of the E-Chain* by clamping onto the aluminum trough

- Quick relocation of the stationary end
- No drilling necessary

Insert for the installation set "Heavy-Duty": **972.50.XXX** instead of (960.30.XXX) on the right column "attached outwards"

Phone +49- (0) 22 03-96 49-800
 Fax +49- (0) 22 03-96 49-222



► chapter 10



► chapter 9



► page 5.91

● ● ● Price index

IPA Qualification Certificate Air
Cleanless Class ISO Class 3
(at v = 2 m/s) upon request

EX ESD classification:
Electrically conductive ESD/ATEX
version upon request

UL UL94 V2 classifications
upon request



Snap-open mechanism, choice of snap-open on left or right. Hinged crossbar can be swiveled by more than 180° on both sides. Lightning-fast closing by hand. Secure fit without additional locking devices.



When to use the Series 3400/3450/3480/3500:

- Snap-open accessibility along both radii
- If integrated strain relief is required at the connection point
- Modular interior separation
- If long service life is required
- If easy installation is required
- If half E-Tube is required (Series 3450)
- If fully enclosed E-Tube is required (Series 3480)



When not to use it:

- If maximum stability is required
▶ **System E4.1, Series E4.42, page 7.48**
- If the application is very simple
▶ **Easy Chain®, Series E300, page 3.52**

- ① Opening system for rapid opening, either from the right or the left
- ② Lateral glide surfaces for side-mounted operation
- ③ Half E-Tube Series 3450
- ④ Tried-and-tested mounting bracket
- ⑤ Series 3400 and 3450
snap-open along inner radius
- ⑥ Integrated strain relief possible
- ⑦ Double stop dog for long unsupported length
- ⑧ Cross bars with high locking range
- ⑨ Fully enclosed E-Tube Series 3480
- ⑩ Modular interior separation
- ⑪ Easy assembly by optimized pin
- ⑫ Also available as ESD version
- ⑬ **Strain relief separator** - Separator with integrated strain relief ▶ **page 5.136**

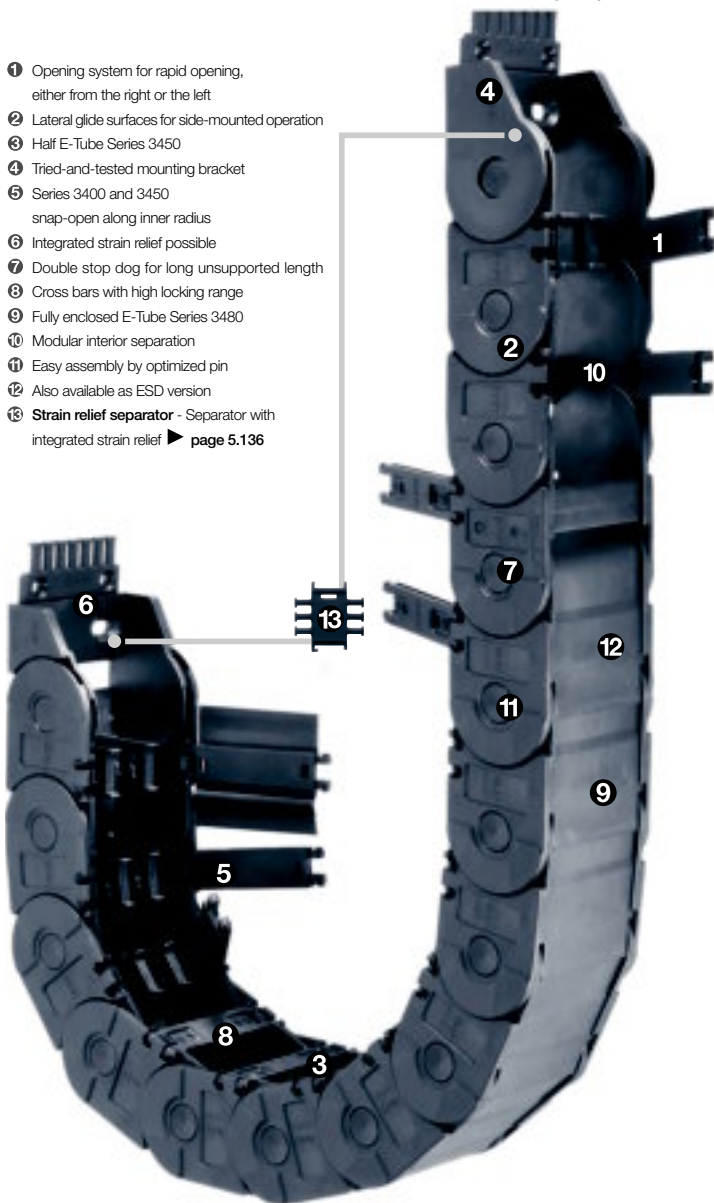

Order example complete E-Chain®

Please indicate chain-lengths or number of links **Example: 3 m or 45 links**

3 m **3400.150.100.0**

E-Chain®

with 2 separators **311** assembled every 2nd link

Interior separation

1 set **3150.34PZB**

Mounting bracket



Unsupported length

FL_G = with straight upper run

FL_B = with permitted sag

Further information ► **Design, page 1.12**

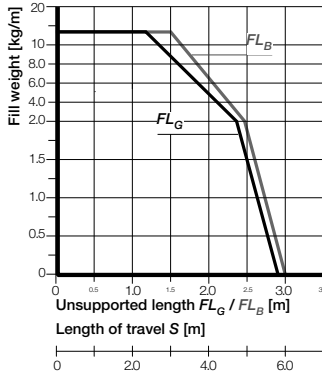
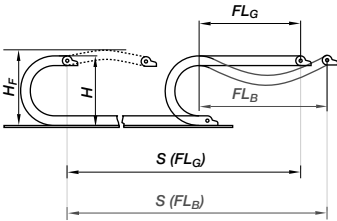

- S = Length of travel
 - R = Bending radius
 - H = Nominal clearance height
 - H_f = Required clearance height
 - H_{RI} = Trough inner height
 - D = Overlength E-Chain® radius in final position
 - $K = \pi \cdot R + \text{"safety"}$
 - D_2 = Over length - long travels, gliding
 - K_2 = "Further add-on"
 - H_2 = "Mounting height"
- *if the mounting bracket location is set lower

Other installation methods

- Vertical, hanging ≤ 80 m
- Vertical, standing ≤ 3 m
- Side mounted, un supp. ≤ 1 m
- Rotary requires further calculation
- Unsupported length of upper run = upon request



Short travels - unsupported

Unsupported E-Chains® feature positive camber over short travels. This must be accounted for when specifying the clearance height H_f . Please consult igus® if space is particularly restricted.

The required clearance height:
 $H_f = H + 40$ mm
(with 2,5 kg/m fill weight)

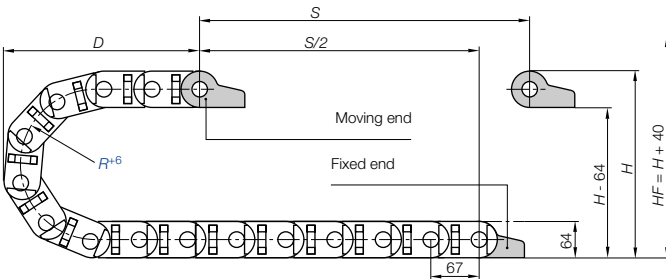

Pitch = 67 mm/link Links/m = 15 (1005 mm) Chain length = $S/2 + K$

	075*	100*	125	150	200	250	300
R	075*	100*	125	150	200	250	300
H	215	265	315	365	465	565	665
D	150	200	225	250	300	350	400
K	400	500	650	725	875	1050	1225
H_2	215	265	186	186	186	186	186
D_2^{*25}	150	200	475	570	780	1010	1150
K_2	400	500	804	1005	1340	1675	1943

*for Series 3450/3480 upon request

Long travel lengths from 10 m to max. 150 m Chain length = $S/2 + K_2$

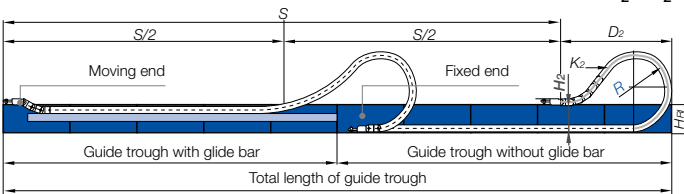

In case of travels between 4 and 10 m we recommend a longer unsupported length.



Gliding, long travel applications (max. 150 m)

In this case the E-Chain® upper run will be introduced in a guide trough on the lower run. We recommend to realize the engineering of such a plant by our technicians.

Technical Data

Speed / acceleration FL_G	max. 20 [m/s] / max. 200 [m/s ²]
Speed / acceleration FL_B	max. 3 [m/s] / max. 6 [m/s ²]
Gliding speed / acceleration (maximum)	max. 10 [m/s] / max. 50 [m/s ²]
Material - permitted temperature °C	igumid G / -40° up to +120° C
Flammability class, igumid G	VDE 0304 IIC UL94 HB



Details of material properties
► page 1.38



For support of the lower run - **Support Tray tool kit** available ► page 9.70



E2/000 medium
Inner height: 45 mm

Phone +49- (0) 22 03-96 49-800
Fax +49- (0) 22 03-96 49-222



► page 5.91

igus® E-ChainSystems®

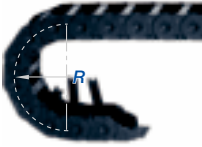
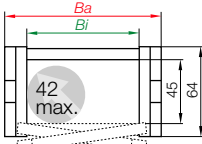

Series 3400 - E-Chain® - snap-open along inner radius

Part No.	Bi [mm]	Ba [mm]	R [mm]	Bending radii							Weight [kg/m]
3400.050.	.0 50	70	075	100	125	150	200	250	300	~ 1,60	
3400.075.	.0 75	95	075	100	125	150	200	250	300	~ 1,78	
3400.100.	.0 100	120	075	100	125	150	200	250	300	~ 1,93	
3400.115.	.0 115	135	075	100	125	150	200	250	300	~ 1,99	
3400.125.	.0 125	145	075	100	125	150	200	250	300	~ 2,03	
3400.150.	.0 150	170	075	100	125	150	200	250	300	~ 2,17	
3400.175.	.0 175	195	075	100	125	150	200	250	300	~ 2,28	
3400.200.	.0 200	220	075	100	125	150	200	250	300	~ 2,45	
3400.225.	.0 225	245	075	100	125	150	200	250	300	~ 2,59	
3400.250.	.0 250	270	075	100	125	150	200	250	300	~ 2,73	

Part No. structure

3400.075.075.0



Supplement Part No. with required radius. Example: 3400.050.075.0

0 = standard color, other colors ▶ page 1.39 · Pitch = 67 mm/link - Links/m = 15



Please note: For using this series for long travels (gliding), please consult with igus® first. For long travels, igus® specifies E-Chains® that snap open on the outer radius.

Phone +49- (0) 22 03-96 49-800
Fax +49- (0) 22 03-96 49-222

igus® GmbH
51147 Cologne

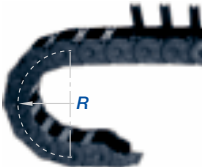
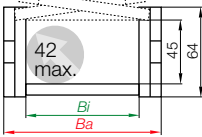

Series 3500 - E-Chain® - snap-open along outer radius - Standard!

Part No.	Bi [mm]	Ba [mm]	R [mm]	Bending radii							Weight [kg/m]
3500.050.	.0 50	70	075	100	125	150	200	250	300	~ 1,60	
3500.075.	.0 75	95	075	100	125	150	200	250	300	~ 1,78	
3500.100.	.0 100	120	075	100	125	150	200	250	300	~ 1,93	
3500.115.	.0 115	135	075	100	125	150	200	250	300	~ 1,99	
3500.125.	.0 125	145	075	100	125	150	200	250	300	~ 2,03	
3500.150.	.0 150	170	075	100	125	150	200	250	300	~ 2,17	
3500.175.	.0 175	195	075	100	125	150	200	250	300	~ 2,28	
3500.200.	.0 200	220	075	100	125	150	200	250	300	~ 2,45	
3500.225.	.0 225	245	075	100	125	150	200	250	300	~ 2,59	
3500.250.	.0 250	270	075	100	125	150	200	250	300	~ 2,73	

Part No. structure

3500.075.075.0



Supplement Part No. with required radius. Example: 3500.050.075.0

0 = standard color, other colors ▶ page 1.39 · Pitch = 67 mm/link - Links/m = 15



Internet: www.igus.eu
E-mail: info@igus.de

Series 3450 - half E-Tube - snap-open along inner radius

Part No.	B_i [mm]	B_a [mm]	R [mm]	Bending radii	Weight [kg/m]
3450.050.	50	70	125	150 200 250 300	~ 1,77
3450.075.	75	95	125	150 200 250 300	~ 1,95
3450.100.	100	120	125	150 200 250 300	~ 2,15
3450.115.	115	135	125	150 200 250 300	~ 2,30
3450.125.	125	145	125	150 200 250 300	~ 2,42
3450.150.	150	170	125	150 200 250 300	~ 2,60
3450.175.	175	195	125	150 200 250 300	~ 2,75
3450.200.	200	220	125	150 200 250 300	~ 2,90
3450.225.	225	245	125	150 200 250 300	~ 3,15
3450.250.	250	270	125	150 200 250 300	~ 3,30

The widths B_i 50/125/150/200/250 are available upon request. Time of delivery approx. 6-8 weeks after order.

The bending radii **075** **100** are available upon request.

Supplement Part No. with required radius. Example: 3450.050. **125**.0

0 = standard color, other colors ▶ page 1.39 · Pitch = 67 mm/link - Links/m = 15



Please note: For using this series for long travels (gliding), please consult with igus® first. For long travels, igus® specifies E-Chains® that snap open on the outer radius.

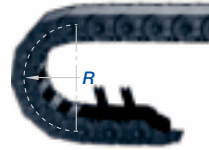
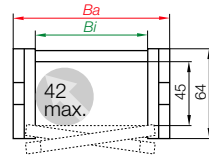

Part No. structure

3450.075. **125**. 0



E2/000 medium
Inner height: 45 mm

Series 3480 - E-Tube - snap-open along inner radius

Part No.	B_i [mm]	B_a [mm]	R [mm]	Bending radii	Weight [kg/m]
3480.050.	50	70	125	150 200 250 300	~ 1,96
3480.075.	75	95	125	150 200 250 300	~ 2,07
3480.100.	100	120	125	150 200 250 300	~ 2,30
3480.115.	115	135	125	150 200 250 300	~ 2,46
3480.125.	125	145	125	150 200 250 300	~ 2,49
3480.150.	150	170	125	150 200 250 300	~ 2,62
3480.175.	175	195	125	150 200 250 300	~ 2,80
3480.200.	200	220	125	150 200 250 300	~ 2,94
3480.225.	225	245	125	150 200 250 300	~ 3,12
3480.250.	250	270	125	150 200 250 300	~ 3,28

The widths B_i 50/125/200/225/250 are available upon request. Time of delivery approx. 6-8 weeks after order.

The bending radii **075** **100** are available upon request.

Supplement Part No. with required radius. Example: 3480.075. **125**.0

0 = standard color, other colors ▶ page 1.39 · Pitch = 67 mm/link - Links/m = 15



Please note: For using this series for long travels (gliding), please consult with igus® first. For long travels, igus® specifies E-Chains® that snap open on the outer radius.

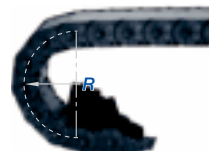
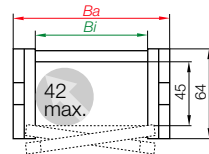

Part No. structure

3480.075. **150**. 0



Phone +49- (0) 22 03-96 49-800
Fax +49- (0) 22 03-96 49-222

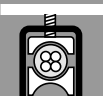
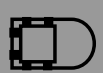

▶ page 5.91



Vertical Separator

unassembled	301
assembled	311



Spacer*

unassembled	305.08
assembled	315.08
unassembled	305.12
assembled	315.12



Strain Relief Separator

unassembled	301.Z
assembled	311.Z



*For side-mounted applications

Option 1: Vertical Separators and Spacer for E-Chains®

Vertical Separators are used if a vertical subdivision of the E-Chain® interior is required -

By standard Vertical Separators are assembled every other E-Chain® link

- **Standard** subdivision (Series 3400/Series 3500) with Vertical Separator 311, for combinations with Full-Width Shelf 2210.X
- If a broad distance shall be kept between the separators or they have to be fixed in their position, e.g. in case of side mounted applications, **Spacer 315.08 and Spacer 315.12** can be used
- **Strain Relief Separator 301.Z**, integrable in the mounting bracket, to position at any point

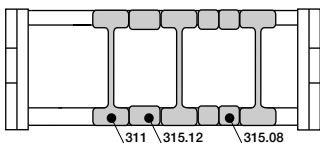

Vert. Separator, slotted

unassembled	302
assembled	312



Vert. Separator, slotted

unassembled	302.24
assembled	312.24



Option 2: Full-Width Shelves for E-Chains®

For applications involving many thin cables with similar or identical diameters

- Vertical Separator, slotted 312 and Vertical Separator, slotted 312.24 (with wide base, e.g. in case of side mounted applications) - for applications with Full-Width Shelf 321.X

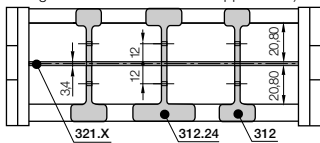

Width X [mm]	Part No.	
	unassembled	assembled
050	320.050	321.050
075	320.075	321.075
100	320.100	321.100
115	320.115	321.115
125	320.125	321.125

Width X [mm]	Part No.	
	unassembled	assembled
150	320.150	321.150
175	320.175	321.175
200	320.200	321.200
225	320.225	321.225
250	320.250	321.250

Full-Width Shelf

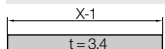

Side Plate

unassembled	303
assembled	313



Middle Plate

unassembled	304
assembled	314



Slotted Separator, open

unassembled	307
assembled	317



Option 3: Shelves for E-Chains®

For applications involving many cables with different diameters. The Shelves can be arranged elevator-shifted with different bottoms within the entire E-Chain® width

- Shelf 2210.X can be combined with Middle Plate 314 and Side Plate 313
- Option 3 "Shelves" can also be combined with option 1 "Vertical Separators"
- Assembling of the Slotted Separator, open 317 in the existing separation afterwards possible

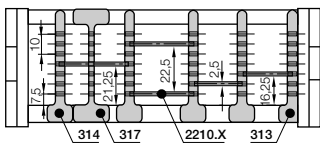

Width X [mm]	Part No.	
	unassembled	assembled
018	2200.18	2210.18
023	2200.23	2210.23
028	2200.28	2210.28
033	2200.33	2210.33
038	2200.38	2210.38
043	2200.43	2210.43
048	2200.48	2210.48

Width X [mm]	Part No.	
	unassembled	assembled
058	2200.58	2210.58
068	2200.68	2210.68
073	2200.73	2210.73
088	2200.88	2210.88
099	2200.99	2210.99
124	2200.124	2210.124
149	2200.149	2210.149

Shelf

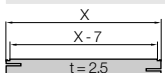

Option 4: Vertical Separators for E-Tubes

Vertical Separators are used if a vertical subdivision of the E-Tube interior is required -

By standard Vertical Separators are assembled every other E-Tube link

- Standard subdivision half E-Tube (Series 3450) and full E-Tube (Series 3480) with Vertical Separator 34511, for combinations with Full-Width Shelf 321.X
- Strain Relief Separator 34501.Z, integrable in the mounting bracket, to position at any point

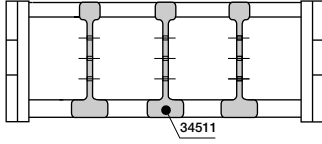
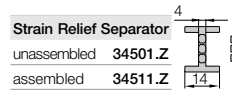
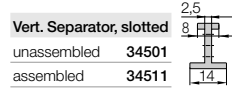

E2/000 medium
Inner height: 45 mm

Option 5: Full-Width Shelves for E-Tubes

For applications involving many thin cables with similar or identical diameters

- Vertical Separator, slotted 34511 - for applications with Full-Width Shelf 321.X

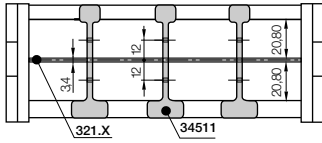

Width X [mm]	Part No. unassembled	Part No. assembled
050	320.050	321.050
075	320.075	321.075
100	320.100	321.100
115	320.115	321.115
125	320.125	321.125

Width X [mm]	Part No. unassembled	Part No. assembled
150	320.150	321.150
175	320.175	321.175
200	320.200	321.200
225	320.225	321.225
250	320.250	321.250

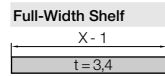

Phone +49- (0) 22 03-96 49-800
Fax +49- (0) 22 03-96 49-222

Option 6: Shelves for E-Tubes

For applications involving many cables with different diameters. The Shelves can be arranged elevator-shifted with different bottoms within the entire E-Chain® width

- Assembling of the Slotted Separator, open 317 in the existing separation afterwards possible
- Shelf 2210.X can be combined with Slotted Separator, open 317

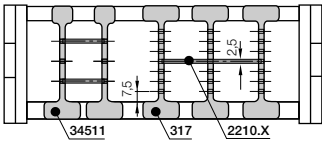
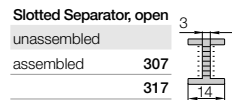

Width X [mm]	Part No. unassembled	Part No. assembled
018	2200.18	2210.18
023	2200.23	2210.23
028	2200.28	2210.28
033	2200.33	2210.33
038	2200.38	2210.38
043	2200.43	2210.43
048	2200.48	2210.48

Width X [mm]	Part No. unassembled	Part No. assembled
058	2200.58	2210.58
068	2200.68	2210.68
073	2200.73	2210.73
088	2200.88	2210.88
099	2200.99	2210.99
124	2200.124	2210.124
149	2200.149	2210.149

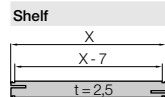



Possible installation conditions for assembled mounting brackets ▶ Order example "preassembled" below

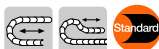

The Standard - option polymer - pivoting

- Recommended for unsupported and gliding applications
- Well suited for tight installation conditions
- Strain relief with detachable tie-wrap plates
- Variable traverse angle for flexible assembly
- The twistability of the E-Chain® and the option to assemble the mounting brackets on the fixed end and/or the moving end, enable various installation options

Moving end with bore
(outer link) 3...3PZ(B)

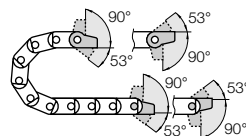

3...4PZ(B) Fixed end
with pin (inner link)



Possible installation conditions for assembled mounting brackets ▶ Order example "preassembled" below

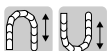

Option polymer - locking

- Recommended for unsupported and gliding applications
- At very high speed and/or acceleration
- If space is limited for height (the H_F measurement)
- The twistability of the E-Chain® and the option to assemble the mounting brackets on the fixed end and/or the moving end, enable various installation options

Moving end with bore
(outer link) 3...1PZ(B)

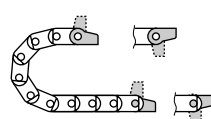

3...2PZ(B) Fixed end
with pin (inner link)

Dimensions and order configurations

Strain relief is possible on the moving end and/or the fixed end.

Part No. structure (pivoting)

3075. 34 PZB A1

A... must be indicated on preassembled configurations
With assembled strain relief tie-wrap plates
Full set pivoting = 34
Mounting brackets for selected chain type

Full set, for both ends:

3075. 34 PZB +tie-wrap plate

Single-part order:

3075. 3 PZB +tie-wrap plate

Mounting bracket with bore

3075. 4 PZB +tie-wrap plate

Mounting bracket with pin

Part No. structure (locking)

3075. 12 PZB A1

A... must be indicated on preassembled configurations
With assembled strain relief tie-wrap plates
Full set locking = 12
Mounting brackets for selected chain type

Full set, for both ends:

3075. 12 PZB +tie-wrap plate

Single-part order:

3075. 1 PZB +tie-wrap plate

Mounting bracket with bore

3075. 2 PZB +tie-wrap plate

Mounting bracket with pin

3...3PZ(B) Standard! (pivoting)

3...1PZ(B) (locking)

Moving end

Standard! (pivoting) 3...4PZ(B)

(locking) 3...2PZ(B)

Fixed end

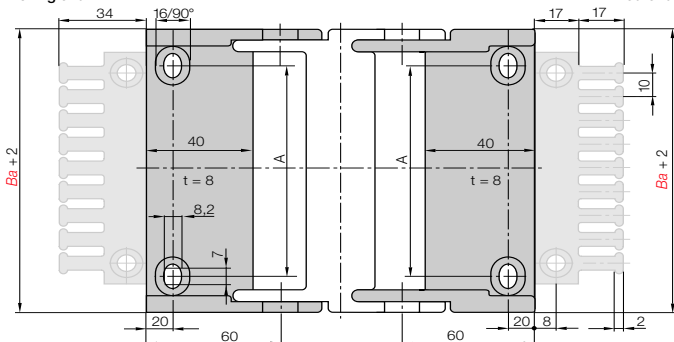

For E-Chain®	Part No. full set with tie-wrap plate	Part No. with tie-wrap plate + 10 cable tiewraps	Part No. full set without tie-wrap plate	Dim. A [mm]
3400 - 3500.050 ▶	3050. PZB	3050. PZBK1	3050. PZ	28
3400 - 3500.075 ▶	3075. PZB	3075. PZBK1	3075. PZ	53
3400 - 3500.100 ▶	3100. PZB	3100. PZBK1	3100. PZ	78
3400 - 3500.115 ▶	3115. PZB	3115. PZBK1	3115. PZ	93
3400 - 3500.125 ▶	3125. PZB	3125. PZBK1	3125. PZ	103
3400 - 3500.150 ▶	3150. PZB	3150. PZBK1	3150. PZ	128
3400 - 3500.175 ▶	3175. PZB	3175. PZBK1	3175. PZ	153
3400 - 3500.200 ▶	3200. PZB	3200. PZBK1	3200. PZ	178
3400 - 3500.225 ▶	3225. PZB	3225. PZBK1	3225. PZ	203
3400 - 3500.250 ▶	3250. PZB	3250. PZBK1	3250. PZ	228

Please add the Part No. with the requested index - 34 for the pivoting configuration

e.g. 3075. 34 PZB or 12 for the locking configuration e.g. 3075. 12 PZB

For the preassembled mode please add the index A1...A4 e.g. 3075. 34 PZB A1



Steel mounting bracket - pivoting

- Pivoting connections
- One part for all chain widths
- Electrically conductive
- Bolted connection outside of chain cross-section possible

Moving end with bore
(outer link) 3000.1

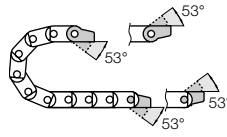

3000.2 Fixed end
with pin (inner link)

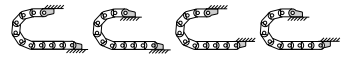

Possible installation conditions -
Further installation angles ► installation sketch

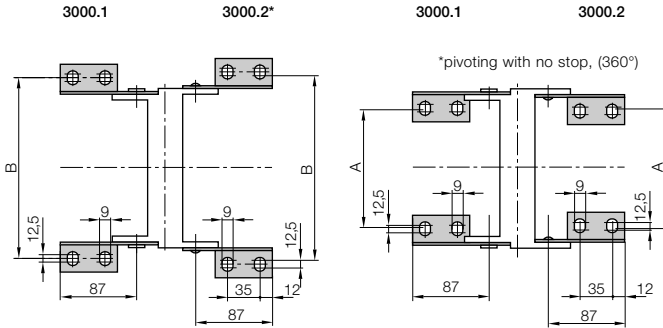

Dimensions and order configurations

For E-Chain*	Part No. full set	Dim. A [mm]	Dim. B [mm]	Dim. C [mm]
3400 - 3500.050 ►	3000. 12	28	86	97
3400 - 3500.075 ►	3000. 12	53	111	122
3400 - 3500.100 ►	3000. 12	78	136	147
3400 - 3500.115 ►	3000. 12	93	151	162
3400 - 3500.125 ►	3000. 12	103	161	172
3400 - 3500.150 ►	3000. 12	128	186	197
3400 - 3500.175 ►	3000. 12	153	212	224
3400 - 3500.200 ►	3000. 12	178	236	247
3400 - 3500.225 ►	3000. 12	203	261	272
3400 - 3500.250 ►	3000. 12	228	286	297

3000.12 Full set, 4 parts

2 with pin / 2 with bore

Single-part order:

3000.1 Mounting bracket

with bore, 1 part left / right

3000.2 Mounting bracket

with pin, 1 part left / right

Phone +49- (0) 22 03-96 49-800
Fax +49- (0) 22 03-96 49-222



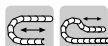

KMA = Polymer Metal Mounting Bracket

Option KMA, pivoting for E-Chains® Series 3400 and Series 3500

- Recommended for unsupported applications
- Bolted connection outside of chain cross-section
- Confined installation conditions
- Universal mountable with attachment capability on all sides
- Stackable

Moving end with bore
Series 3400 = 34001...1
Series 3500 = 34001...1

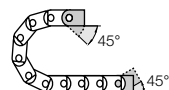

Series 3400 = 34001...2

Series 3400 = 34001...2

Fixed end with pin

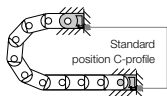

The attachment variants arising automatically by the choice of the KMA mounting bracket



KMA = Polymer Metal Mounting Bracket

Option KMA, locking for E-Chains® Series 3400 and Series 3500

- Recommended for vertical hanging / standing applications
- Bolted connection outside of chain cross-section
- At very high speed and acceleration
- Universal mountable with attachment capability on all sides
- Stackable

Moving end with bore

Series 3400 = 34101...1

Series 3500 = 34101...1

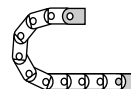

Series 3400 = 34101...2

Series 3500 = 34101...2

Fixed end with pin

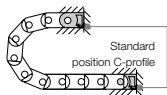

The attachment variants arising automatically by the choice of the KMA mounting bracket

Dimensions and order configurations

Part No. structure (pivoting)

34001.050.12.C.A



Full set, for both ends:

34001.050.12.C (with C-profile)

Single-part order:

34001.050.1.C (with C-profile)

Mounting bracket with bore

34001.050.2.C (with C-profile)

Mounting bracket with pin

Part No. structure (locking)

34101.050.12.C.A



Full set, for both ends:

34101.050.12.C (with C-profile)

Single-part order:

34101.050.1.C (with C-profile)

Mounting bracket with bore

34101.050.2.C (with C-profile)

Mounting bracket with pin

3400 | 3500 = 34001...1 (pivoting)

3400 | 3500 = 34101...1 (locking)

Moving end

ø 5,5

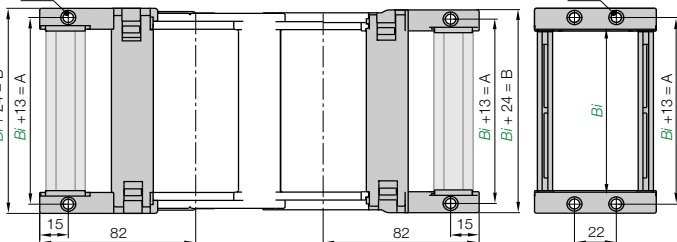

3400 | 3500 = 34001...2 (pivoting)

3400 | 3500 = 34101...2 (locking)

Fixed end

ø 5,5

For E-Chain®	Part No. full set with C-profile	Part No. full set without C-profile	Dim. A [mm]	Dim B [mm]
Series 3400/3500				
3400/3500.050	34001.050.12.C	34001.050.12	63	74
3400/3500.075	34001.075.12.C	34001.075.12	88	99
3400/3500.100	34001.100.12.C	34001.100.12	113	124
3400/3500.115	34001.115.12.C	34001.115.12	128	139
3400/3500.125	34001.125.12.C	34001.125.12	138	149
3400/3500.150	34001.150.12.C	34001.150.12	163	174
3400/3500.175	34001.175.12.C	34001.175.12	188	199
3400/3500.200	34001.200.12.C	34001.200.12	213	224
3400/3500.225	34001.225.12.C	34001.225.12	238	249
3400/3500.250	34001.250.12.C	34001.250.12	263	274

● For E-Chains® please add the Part No. with the requested index

For the pivoting option e.g. 34001.050.12 or for the locking option e.g. 34101.050.12

For the preassembled mode please add the index A e.g. 34101.050.12A

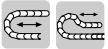

KMA = Polymer Metal Mounting Bracket

Option KMA, pivoting for half E-Tubes Series 3450 and for full E-Tubes Series 3480

- Recommended for unsupported applications
- Bolted connection outside of chain cross-section
- Confined installation conditions
- Universal mountable with attachment capability on all sides
- Stackable

Moving end with bore

Series 3450 = 34500...1

Series 3480 = 34800...1

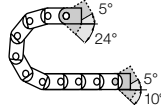

Series 3450 = 34500...2

Series 3480 = 34800...2

Fixed end with pin



The attachment variants arising automatically by the choice of the KMA mounting bracket

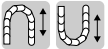
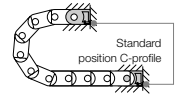

KMA = Polymer Metal Mounting Bracket

Option KMA, locking for half E-Tubes Series 3450
Option KMA, locking for full E-Tubes Series 3480

- Recommended for vertical hanging / standing applications
- Bolted connection outside of chain cross-section
- At very high speed and acceleration
- Universal mountable with attachment capability on all sides
- Stackable

Moving end with bore

Series 3450 = 34510...1

Series 3480 = 34810...1

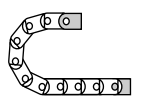

Series 3450 = 34510...2

Series 3480 = 34810...2

Fixed end with pin



The attachment variants arising automatically by the choice of the KMA mounting bracket

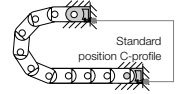

3450 = 34500...1 | 3480 = 34800...1 (pivoting)
3450 = 34510...1 | 3480 = 34810...1 (locking)

3450 = 34500...2 | 3480 = 34800...2 (pivoting)
3450 = 34510...2 | 3480 = 34810...2 (locking)

Moving end

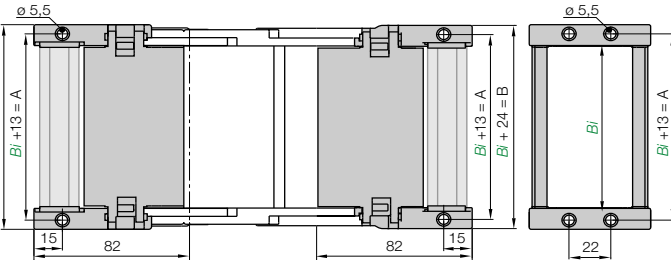

Fixed end

Dimensions and order configurations

Part No. structure (pivoting)

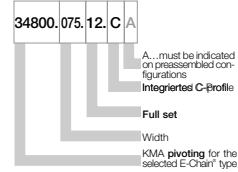

Full set, for both ends:

34800.075.12.C (with C-profile)

Single-part order:

34800.075.1.C (with C-profile)

Mounting bracket with bore

34800.075.2.C (with C-profile)

Mounting bracket with pin

Part No. structure (locking)

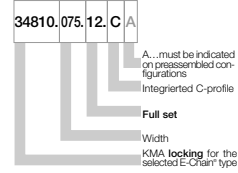

Full set, for both ends:

34810.075.12.C (with C-profile)

Single-part order:

34810.075.1.C (with C-profile)

Mounting bracket with bore

34810.075.2.C (with C-profile)

Mounting bracket with pin

For E-Chain*	Part No. full set with C-profile	Part No. full set without C-profile	Dim. A [mm]	Dim B [mm]
Series 3450/3480				
3450/3480.050	050.12.C	050.12	63	74
3450/3480.075	075.12.C	075.12	88	99
3450/3480.100	100.12.C	100.12	113	124
3450/3480.115	115.12.C	115.12	128	139
3450/3480.125	125.12.C	125.12	138	149
3450/3480.150	150.12.C	150.12	163	174
3450/3480.175	175.12.C	175.12	188	199
3450/3480.200	200.12.C	200.12	213	224
3450/3480.225	225.12.C	225.12	238	249
3450/3480.250	250.12.C	250.12	263	274

- For **half E-Tube** please add the Part No. with the requested index
For the pivoting option e.g. 34500.075.12 or for the locking option e.g. 34510.075.12
For the **preassembled** mode please add the index [A] e.g. 34510.075.12[A]
- For **full E-Tube** please add the Part No. with the requested index
For the pivoting option e.g. 34800.075.12 or for the locking option e.g. 34810.075.12
For the **preassembled** mode please add the index [A] e.g. 34810.075.12[A]

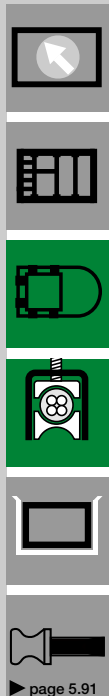



Tiewrap plate as individual part

As individual component screwed on KMA. Can be plugged in the mounting brackets. **Details ▶ chapter 10**

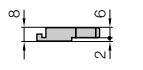

Single tiewrap plate

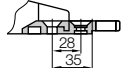

Shown assembled

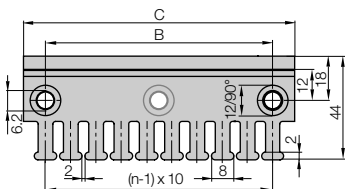

Tiewrap plate	No. of teeth n	Dim. C [mm]	Dim. B [mm]
3050.ZB	5	50	30
3075.ZB	7	75	55
3100.ZB	10	100	80
3115.ZB	11	115	95
3125.ZB	12	125	105
3150.ZB	15	150	130
3175.ZB	17	175	155
3200.ZB	20	200	180
3225.ZB	22	225	205
3250.ZB	25	250	230

(- = no / + = yes)



Cable tiewraps as individual part

Cable tiewraps (100-piece bag)	Width x length	max. Ø	Tensile strength
CFB.001	4,8 x 150 mm	36 mm	222 N



"Double" strain relief

If an E-Chain® is harnessed with a very large number of cables, strain relief may be necessary at two levels. Our 30XX.Z and 30XX.ZS strain relief system was developed for this purpose. It can be placed in any position along the E-Chain®. As required, the 30XX.Z and 30XX.ZS strain relief system is simply clamped onto the crossbar of the chain link. No additional installation elements are needed. **Details ▶ chapter 10**

Art. Nr. crossbar (fixed)	Width [mm]	No. of teeth
3050.Z*	50	5
3075.Z*	74	7

Art. Nr. crossbar (openable)	Width [mm]	No. of teeth
3035.ZS**	35	3
3050.ZS**	50	5
3075.ZS**	75	7

*not available for Series 3450 and 3480 **not available for Series 3480

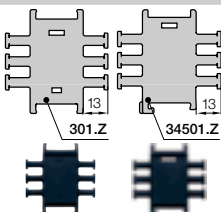

Strain relief separator

Separator with integrated strain relief, for use in the first or last chain link. For manufacturing of switchgear cabinets or for the assembly of machines. Easy to assemble without any fastening device. Separator base 2020.Z is 18 mm and 34501.Z is 14 mm wide. The possible number of separators per E-Chain® is defined by its inner width B_i and by the cable-diameter. **Details ▶ chapter 10**

Part No.	Number of teeth	For Series
301.Z	3 both sides	3400/3500 E-Chain®
34501.Z	3 both sides	3450/3480 E-Tube



Strain relief for steel mounting brackets

Clip-on connection is not possible with steel mounting brackets. In this case, the tiewrap plates must be bolted directly into separate bore holes in front of the mounting bracket. Alternatively the tiewrap plates 30XX.Z and ZS can be also used here. **Details ▶ chapter 10**

Chainfix strain relief C-profile-solutions - more Details ▶ chapter 10



Other strain relief elements - optional ▶ chapter 10



Chainfix clamps made of steel or stainless steel



Chainfix Clips - modular, snap-on



Chainfix Nugget with pre-harnessed cable strap



Chainfix - tiewrap plates with clip-on connection

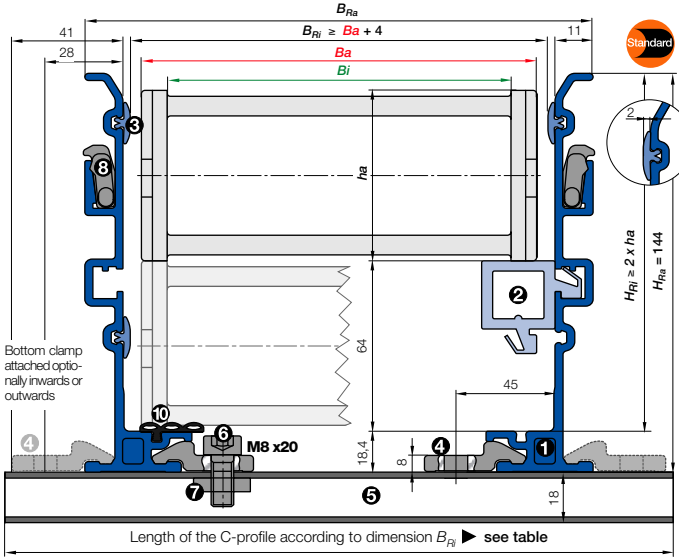

- B_a = Outer width E-Chains* / E-Tube
 - B_i = Inner width E-Chains* / E-Tube
 - h_a = Outer height E-Chains* / E-Tube
 - H_{Ri} = Inner trough height
 - H_{Ra} = Outer trough height
 - B_{Ri} = Inner trough width ► depends on dim. B_a
 - B_{Ra} = Outer trough width
 - n_{Mon} = Number of installation sets (left/right)
 - n_{Ri} = Number of trough sets (left/right)
- $H_{Ri} \geq 2 \cdot h_a$
 $B_{Ri} \geq B_a + 4$
- = Guide trough set ● = Glide bar
 - = Installation set "Basic" ● = C-Profile

Installation set "Basic" with C-Profile

Bottom Clamp attached optionally inwards or outwards

3500.075.200.0 ► Order example

B_{Ri} [mm]	Part No.	
	attached inwards	attached outwards
.050 74	-	960.40.200
.075 99	-	960.40.225
.100 124	960.40.175	960.40.250
.115 139	960.40.200	960.40.275
.125 149	960.40.200	960.40.275
.150 174	960.40.225	960.40.300
.175 199	960.40.250	960.40.325
.200 224	960.40.275	960.40.350
.225 249	960.40.300	960.40.375
.250 274	960.40.325	960.40.400



- **Components, trough "Basic":** ① Trough side parts, aluminum, 2 m ② Glide bar, plastic, 2 m ③ Glide strips, plastic, 2 m (without glide strips on request) ⑩ Optional: Silencer profile, rubber
- **Components, installation set "Basic":** ④ Bottom clamp, aluminum ⑤ C-profile, steel galvanized ⑥ Screw M6 x16 ⑦ Sliding nut M6 ⑧ Interface connector, plastic

Order example: Length of travel 30 m - Center mounted for Series 3500.100.200.0 with $B_{Ri} = 124$

- Guide trough set (set of 2 trough side parts, incl. glide strips) **without** glide bar
Order text: 16 m guide trough without glide bar (8 x 2 m sections) Part No. 973.30.SL
- Guide trough set (set of 2 trough side parts, incl. glide strips) **with** glide bar
Order text: 16 m guide trough with glide bar (8 x 2 m sections) Part No. 973.31.SL
- Installation set "Basic" complete (guide trough-sets + 1)
Order text: 17 installation sets "Basic" Part No. 960.40.175
- Module for the fixed end
Order text: 1 set Part No. 973.80
- Option:** For an additional noise dampening with silencer profile, please add Index A - Example:
Part No. 973.30.SLA

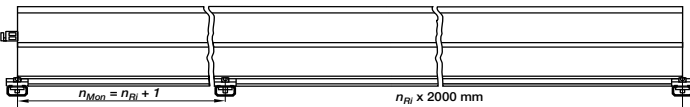

Principle sketch: Number of installation sets to be installed = **Number of trough sections + 1**

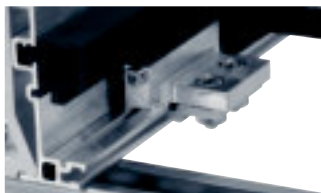

A quick fix for mounting the stationary end of an E-Chain*
 With this module for the fixed end, fast and easy mounting onto the Aluminum "SuperTrough" is now possible without any drilling. Fast mounting of the E-Chain* by clamping onto the aluminum trough

- Quick relocation of the stationary end
- No drilling necessary

Insert for the installation set "Heavy-Duty": **973.50.XXX** instead of (960.40.XXX) on the right column "attached outwards"

Phone +49- (0) 22 03-96 49-800
 Fax +49- (0) 22 03-96 49-222

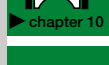

► page 5.91



Price index



IPA Qualification Certificate Air
Cleanless Class ISO Class 3
(at $v = 2$ m/s) upon request



ESD classification:
Electrically conductive ESD/ATEX
version upon request



UL94 V2 classifications
upon request

- ❶ Snap-open, hinged to left or right, accessible from the top
- ❷ Lateral glide surfaces for side-mounted operation
- ❸ Large pins for long service life
- ❹ Introduction bevel - easy assembly
- ❺ Small pitch for very quiet operation
- ❻ Integrated strain relief possible
- ❼ Smooth interior for long cable life
- ❽ Dirt-repellent exterior
- ❾ Modular interior separation



1. To open crossbars press screwdriver into tab on top of link, lever screwdriver until crossbar opens. 2. Repeat step 1 on other side.



When to use the Series 255:

- If quieter operation at very high speeds is required
- If integrated strain relief is required at the connection point
- If modular interior separation required
- If easy installation is required



When not to use it:

- If each link requires snap-open accessibility on both sides
 - ▶ System E4.1, Series E4.21, page 7.16
- If maximum stability is required
 - ▶ System E4.1, Series E4.21, page 7.16
- If the application is very simple
 - ▶ Easy Chain®, Series E200, page 3.36

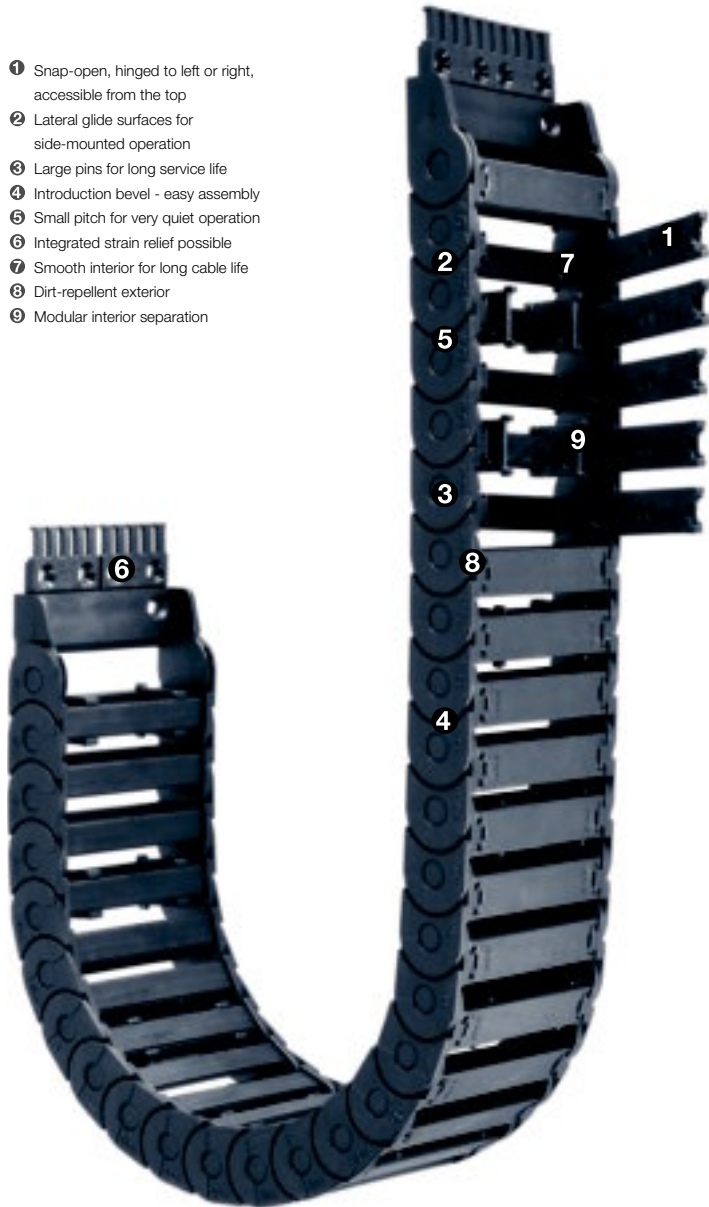

Order example complete E-Chain®

Please indicate chain-lengths or number of links Example: 2 m or 72 links

2 m 255.10.100.0



E-Chain®

with 2 separators 2552 assembled every 2nd link



Interior separation

1 set 2100.34PZ1B



Mounting bracket



Unsupported length

FL_G = with straight upper run

FL_B = with permitted sag

Further information ► **Design, page 1.12**

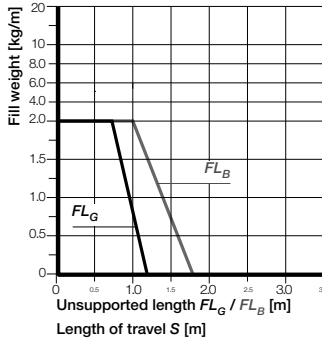
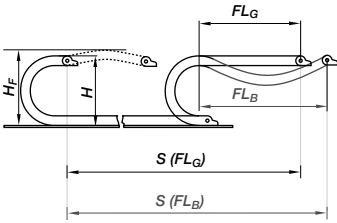

- S = Length of travel
 - R = Bending radius
 - H = Nominal clearance height
 - H_F = Required clearance height
 - H_{RI} = Trough inner height
 - D = Overlength E-Chain® radius in final position
 - K = $\pi \cdot R$ + "safety"
 - D_2 = Over length - long travels, gliding
 - K_2 = "Further add-on"
 - H_2 = "Mounting height"
- *if the mounting bracket location is set lower

Other installation methods

- Vertical, hanging ≤ 40 m
- Vertical, standing ≤ 3 m
- Side mounted, un supp. ≤ 1 m
- Rotary requires further calculation
- Unsupported length of upper run = upon request



Short travels - unsupported

Unsupported E-Chains® feature positive camber over short travels. This must be accounted for when specifying the clearance height H_F . Please consult igus® if space is particularly restricted.

The required clearance height:
 $H_F = H + 25$ mm
 (with 1,5 kg/m fill weight)

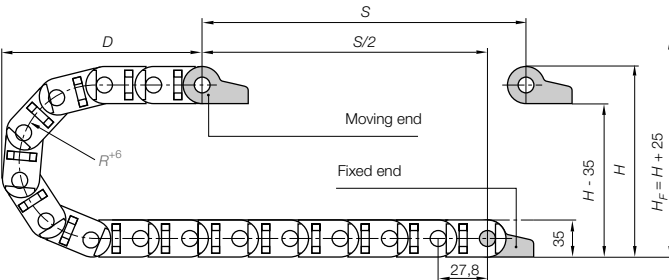

Pitch = 27,8 mm/link Links/m = 36 (1000,8 mm) Chain length = $S/2 + K$

R	055	075	100	125	150	175	200	225	250
$H + \frac{1}{4}$	145	185	235	285	335	385	435	485	535
D	108	133	153	178	203	228	253	278	303
K	242	312	380	462	544	626	708	780	866
H_2	145	185	100	100	100	100	100	100	100
$D_2 + 25$	108	133	380	495	570	665	740	1040	1130
K_2	242	312	612	806	945	1112	1223	1610	1779

Long travel lengths from 10 m to max. 100 m Chain length = $S/2 + K_2$

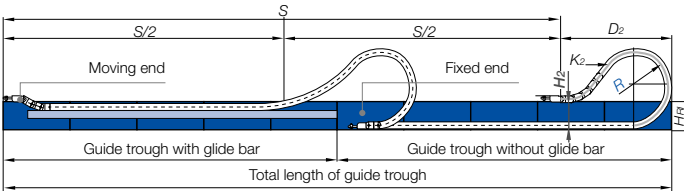

In case of travels between 4 and 10 m we recommend a longer unsupported length.



Gliding, long travel applications (max. 100 m)

In this case the E-Chain® upper run will be introduced in a guide trough on the lower run. We recommend to realize the engineering of such a plant by our technicians.

Technical Data

Speed / acceleration FL_G	max. 20 [m/s] / max. 200 [m/s²]
Speed / acceleration FL_B	max. 3 [m/s] / max. 6 [m/s²]
Gliding speed / acceleration (maximum)	max. 10 [m/s] / max. 50 [m/s²]
Material - permitted temperature °C	igumid G / -40° up to +120° C
Flammability class, igumid G	VDE 0304 IIC UL94 HB



Details of material properties
 ► page 1.38



E2 medium
 Inner height: 24 mm

Tel. +49- (0) 22 03-96 49-800
 Fax +49- (0) 22 03-96 49-222



► page 5.91

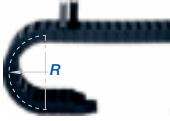
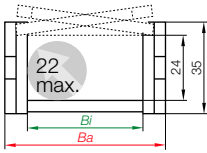

Part No. structure

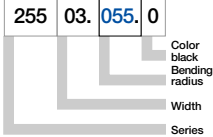

Series 255 - snap-open along outer radius

Part No.	Bi [mm]	Ba [mm]	R [mm]	Bending radii								Weight [kg/m]
255.03.□.0	38	54	055	075	100	125	150	175	200	225	250	≈ 0,81
255.05.□.0	57	73	055	075	100	125	150	175	200	225	250	≈ 0,90
255.07.□.0	77	93	055	075	100	125	150	175	200	225	250	≈ 1,01
255.10.□.0	103	119	055	075	100	125	150	175	200	225	250	≈ 1,15

Supplement Part No. with required radius. Example: 255.03.055.0

0 = standard color, other colors ► page 1.39 · Pitch = 27,8 mm/link - Links/m = 36



Option 1: Vertical Separators

Vertical Separators are used if a vertical subdivision of the E-Chain® interior is required -

By standard Vertical Separators are assembled every other E-Chain® link

- Standard subdivision with Vertical Separator, slotted 2552 or Vertical Separator, slotted 2554 for combinations with Full-Width Shelf 221.X (Determining which type of separator to use is dependent on any potential retrofit requirements.)

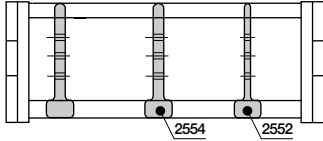

Vert. Separator, slotted		
unassembled	2551	
assembled	2552	
unassembled	2553	
assembled	2554	



E2 medium
Inner height: 24 mm

Option 2: Full-Width Shelves

For applications involving many thin cables with similar or identical diameters

- Vertical Separator, slotted 2552 oder Vertical Separator, slotted 2554 - for applications with Full-Width Shelf 221.X

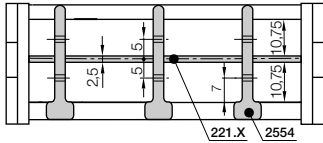

Width X [mm]	Part No. unassembled	Part No. assembled
038	220.38	221.38
057	220.57	221.57

Width X [mm]	Part No. unassembled	Part No. assembled
077	220.77	221.77
103	220.103	221.103

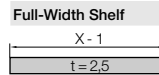

Phone +49- (0) 22 03-96 49-800
Fax +49- (0) 22 03-96 49-222

Option 3: Shelves

For applications involving many cables with similar or identical diameters. Partial separation into individual chambers can be achieved and the entire width B/-10 mm can be used

- Shelf 2210.X can be combined with Vertical Separator, slotted 2552 (also as adjustable vertical separators without shelves) or Vertical Separator, slotted 2554
- Option 3 "Shelves" can also be combined with option 1 "Vertical Separators".

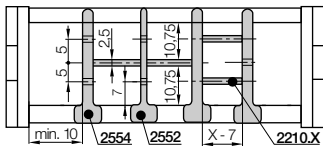

Width X [mm]	Part No. unassembled	Part No. assembled
018	2200.18	2210.18
023	2200.23	2210.23
028	2200.28	2210.28
033	2200.33	2210.33
038	2200.38	2210.38
043	2200.43	2210.43

Width X [mm]	Part No. unassembled	Part No. assembled
048	2200.48	2210.48
058	2200.58	2210.58
068	2200.68	2210.68
073	2200.73	2210.73
088	2200.88	2210.88

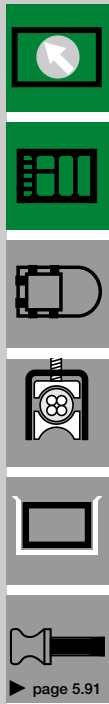
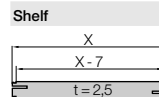

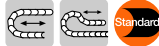

The Standard - option polymer - pivoting

- Recommended for unsupported and gliding applications
- Well suited for tight installation conditions
- Strain relief with detachable tiwrap plates
- Variable traverse angle for flexible assembly
- The twistability of the E-Chain® and the option to assemble the mounting brackets on the fixed end and/or the moving end, enable various installation options

Moving end with bore (outer link) 2...3PZ1(B)

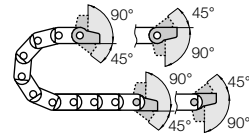

2...4PZ1(B) Fixed end with pin (inner link)

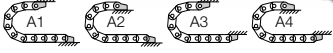

Possible installation conditions for assembled mounting brackets ▶ Order example "preassembled" below

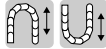

Option polymer - locking

- Recommended for unsupported and gliding applications
- At very high speed and/or acceleration
- If space is limited for height (the H_F measurement)
- The twistability of the E-Chain® and the option to assemble the mounting brackets on the fixed end and/or the moving end, enable various installation options

Moving end with bore (outer link) 2...1PZ1(B)

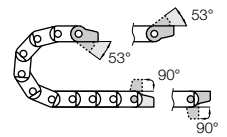

2...2PZ1(B) Fixed end with pin (inner link)



Possible installation conditions for assembled mounting brackets ▶ Order example "preassembled" below

Dimensions and order configurations

Strain relief is possible on the moving end and/or the fixed end.

Part No. structure (pivoting)

2030. 34 PZ1B A1 Standard

A... must be indicated on preassembled configurations
With assembled strain relief tiwrap plates
Full set pivoting = 34
Mounting brackets for selected chain type

Full set, for both ends:

2030. 34 PZ1B +tiwrap plate

Single-part order:

2030. 3 PZ1B +tiwrap plate

Mounting bracket with bore

2030. 4 PZ1B +tiwrap plate

Mounting bracket with pin

Part No. structure (locking)

2030. 12 PZ1B A1

A... must be indicated on preassembled configurations
With assembled strain relief tiwrap plates
Full set locking = 12
Mounting brackets for selected chain type

Full set, for both ends:

2030. 12 PZ1B +tiwrap plate

Single-part order:

2030. 1 PZ1B +tiwrap plate

Mounting bracket with bore

2030. 2 PZ1B +tiwrap plate

Mounting bracket with pin

2...3PZ1(B) Standard! (pivoting)

2...1PZ1(B) (locking)

Moving end

Standard! (pivoting) 2...4PZ1(B)

(locking) 2...2PZ1(B)

Fixed end

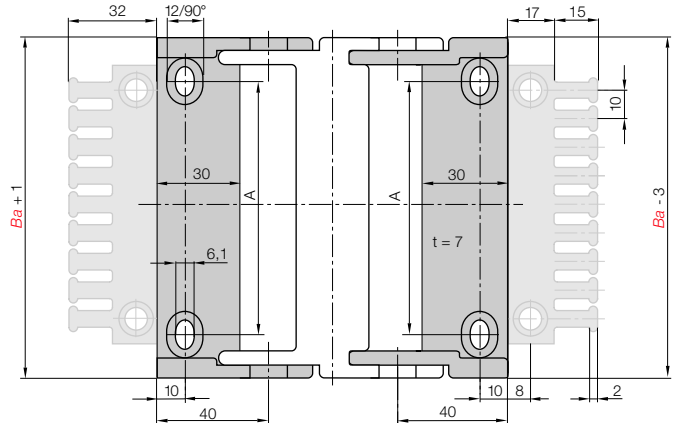

For E-Chain®	Part No. full set with tiwrap plate	Part No. with 10 cable tiwraps	Part No. full set without tiwrap plate	Dim. A [mm]
255.03 ▶	2030. <input type="checkbox"/> PZ1B	2030. <input type="checkbox"/> PZ1BK1	2030. <input type="checkbox"/> PZ1	25
255.05 ▶	2050. <input type="checkbox"/> PZ1B	2050. <input type="checkbox"/> PZ1BK1	2050. <input type="checkbox"/> PZ1	44
255.07 ▶	2070. <input type="checkbox"/> PZ1B	2070. <input type="checkbox"/> PZ1BK1	2070. <input type="checkbox"/> PZ1	64
255.10 ▶	2100. <input type="checkbox"/> PZ1B	2100. <input type="checkbox"/> PZ1BK1	2100. <input type="checkbox"/> PZ1	90

Please add the Part No. with the requested index - 34 for the pivoting configuration

e.g. 2030. 34 PZ1B or 12 for the locking configuration e.g. 2030. 12 PZ1B

For the preassembled mode please add the index A1...A4 e.g. 2030. 34 PZ1B A1

igus® GmbH
51147 Cologne

Internet: www.igus.eu
E-mail: info@igus.de

Strain Relief for polymer mounting brackets (pivoting or locking)

The strain relief plates can be snapped directly onto the mounting bracket without additional hardware. When the mounting brackets are bolted into place, the strain relief plates are also firmly connected to the machine surface. No separate installation is necessary. Cable tiewraps secure cables using the "teeth" of the tiewrap plate for time-saving, effective strain relief. **Details ▶ chapter 10**



Tiewrap plate	No. of teeth <i>n</i>	Dim. C [mm]	Dim. B [mm]
2020.ZB	3	30	15
2030.ZB	4	40	20
2040.ZB	5	50	30
2050.ZB	6	60	40
2070.ZB	8	80	60
2090.ZB = (2030.ZB + 2040.ZB)	9	90	-
2100.ZB	10	100	80
2125.ZB = (2050.ZB + 2050.ZB)	12	120	-

Tiewrap plate as individual part

As individual component screwed on KMA. Can be plugged in the mounting brackets. **Details ▶ chapter 10**

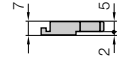
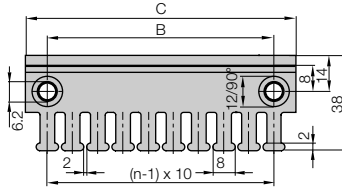

Single tiewrap plate



Shown assembled

Cable tiewraps as individual part

Cable tiewraps (100-piece bag)	Width x length	max. Ø	Tensile strength
CFB.001	4,8 x 150 mm	36 mm	222 N



Other strain relief elements - optional ▶ chapter 10

E2 medium
Inner height: 24 mm

Phone +49- (0) 22 03-96 49-800
Fax +49- (0) 22 03-96 49-222



▶ chapter 10



▶ page 5.91

- Ba** = Outer width E-Chains® / E-Tube
 - Bi** = Inner width E-Chains® / E-Tube
 - ha** = Outer height E-Chains® / E-Tube
 - H_{Ri}** = Inner trough height
 - H_{Ra}** = Outer trough height
 - B_{Ri}** = Inner trough width ▶ depends on dim. **Ba**
 - B_{Ra}** = Outer trough width
 - n_{Mon}** = Number of installation sets (left/right)
 - n_{Ri}** = Number of trough sets (left/right)
- $H_{Ri} \geq 2 \cdot ha$
 $B_{Ri} \geq Ba + 4$
- = Guide trough set
 - = Glide bar
 - = Installation set "Basic"
 - = C-Profile

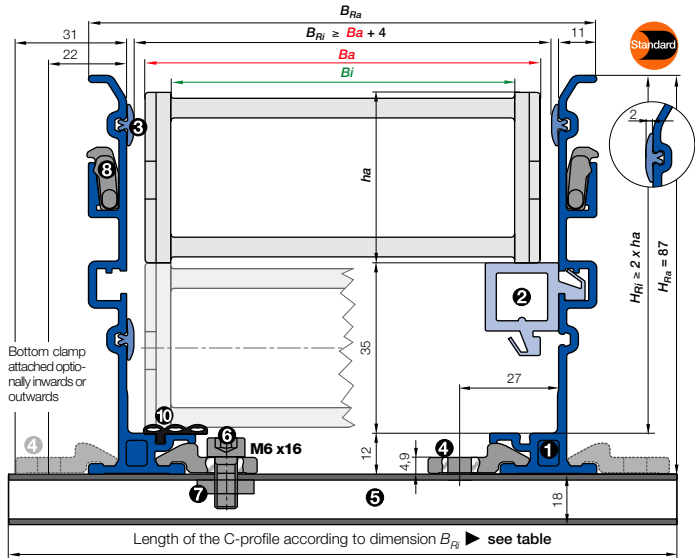

- **Components, trough "Basic":** ① Trough side parts, aluminum, 2 m ② Glide bar, plastic, 2 m ③ Glide strips, plastic, 2 m (without glide strips on request) ⑩ Optional: Silencer profile, rubber
- **Components, installation set "Basic":** ④ Bottom clamp, aluminum ⑤ C-profile, steel galvanized ⑥ Screw M6 x16 ⑦ Sliding nut M6 ⑧ Interface connector, plastic

Installation set "Basic" with C-Profile

Bottom Clamp attached optionally inwards or outwards

255.05.200.0 ▶ Order example

B_{Ri} [mm]	Part No.	
	attached inwards	attached outwards
.03 58	-	960.30.150
.05 77	960.30.125	960.30.175
.07 97	960.30.150	960.30.200
.10 123	960.30.175	960.30.225

"Heavy-Duty": **971.50.XXX**
 instead of (**960.30.XXX**) on the right column "attached outwards"



Order example: Length of travel 30 m - Center mounted for Series 255.05.200.0 with $B_{Ri} = 77$

- Guide trough set (set of 2 trough side parts, incl. glide strips) **without** glide bar
Order text: 16 m guide trough without glide bar (8 x 2 m sections) **Part No. 971.30.SL**
- Guide trough set (set of 2 trough side parts, incl. glide strips) **with** glide bar
Order text: 16 m guide trough with glide bar (8 x 2 m sections) **Part No. 971.31.SL**
- Installation set "Basic" complete (guide trough-sets + 1)
Order text: 17 installation sets "Basic" **Part No. 960.30.150**
- Option:** For an additional noise dampening with silencer profile, please add Index A - Example: **Part No. 971.30.SLA**

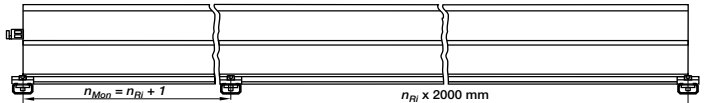

Principle sketch: Number of installation sets to be installed = Number of trough sections + 1

Phone +49- (0) 22 03-96 49-800
 Fax +49- (0) 22 03-96 49-222

igus® GmbH
 51147 Cologne

Internet: www.igus.eu
 E-mail: info@igus.de

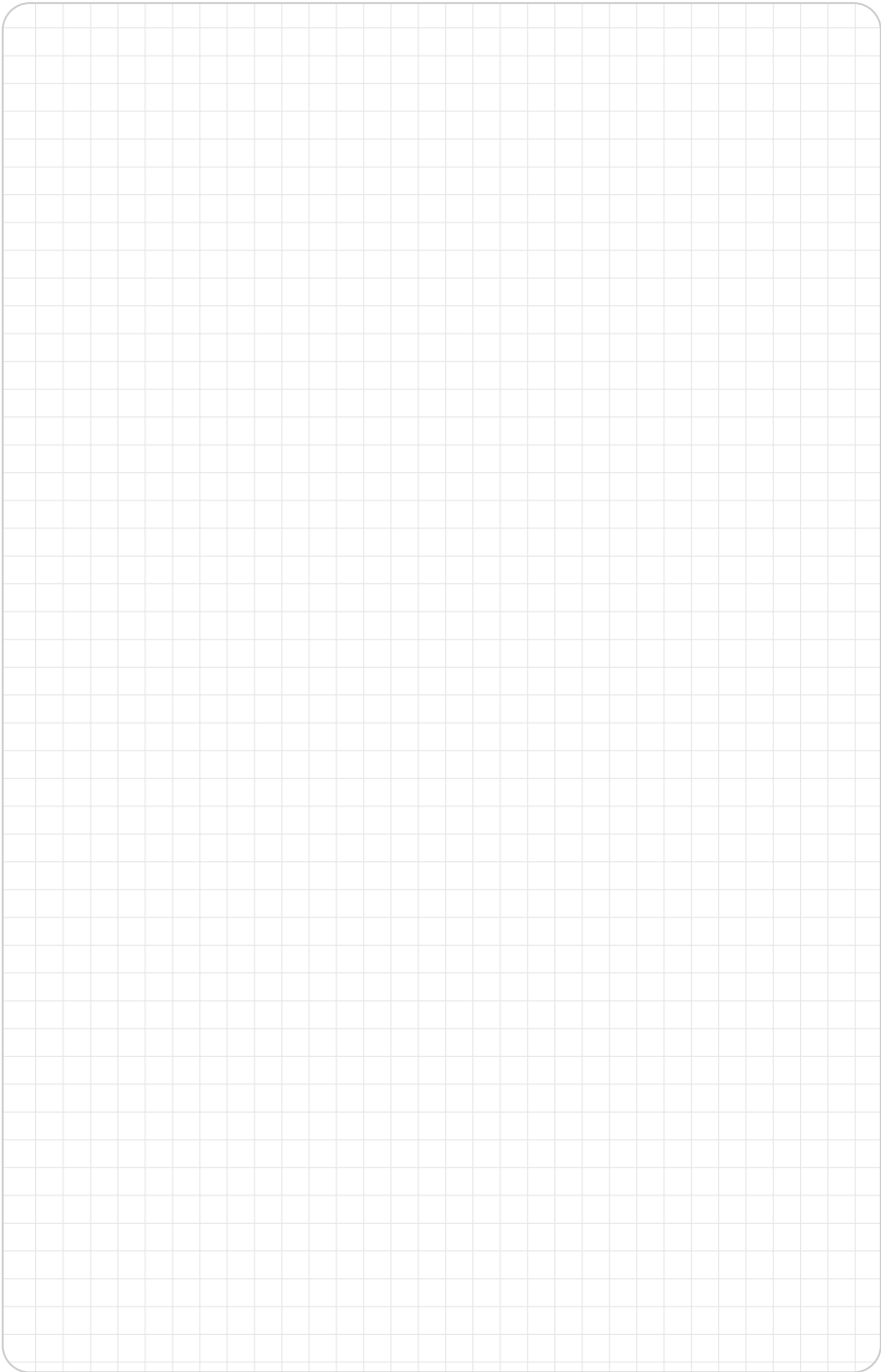

E2 medium
Inner height: 24 mm

Phone +49- (0) 22 03-96 49-800
Fax +49- (0) 22 03-96 49-222



▶ chapter 9



▶ page 5.91



igus[®] E-Tubes



E2 E-Tubes - protection in environments with dirt and debris

E2 Series R100 and Series R

Since igus® introduced the first openable E-Tubes in the mid-1980's, many additions and improvements have been introduced in the program. igus® E-Tubes work in hot chip areas, in areas of dirt and dust generated by woodworking, steelmills, pulp and paper, textile, agriculture, coal plant and many other hostile environment.

Typical industries and applications

- Tooling machines
- Woodworking machines
- All kind of industries and machines with chip, dirt and dust



iF-Design Awards -
Series R117/118 and Series R68



ESD Classification: Electrically conductive
ESD/ATEX version upon request



UL94-V2 classifications upon request



E-Tubes with HT-material for hot chips
up to 850°C available upon request



Series R100 - Cost effective alternative, for applications with low and medium speeds



Series R - For higher speeds and smooth running





E2 E-Tubes in chip-area of a tooling machine. Resistant against hot metal chips up to 850°C



U-shaped supported E-Tube
for high lateral acceleration



Standing application - R68 Tube -
Note: the first links are supported

RX40 - Totally new E-Tube with chip repellent design

A world premiere from igus® - a totally redesigned E-Tube - repels chips, is extremely tight, and still openable!

Series RX40 ► from page 6.50



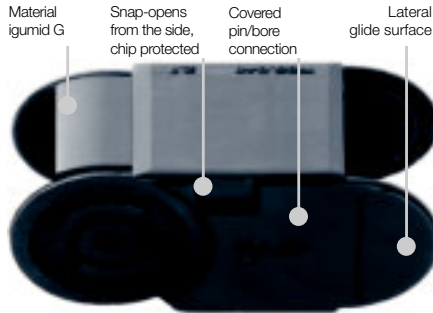

E2 Series R100 - robust and tight

- Very good protection against chips (also hot chips)
- Hinged, snap-open, removable lids along inner and outer radius reduce assembly time
- Space-efficient with optimized ratio of inner dimension to outer dimension
- Double stop dog for long service life and strong unsupported lengths
- Universal KMA mounting brackets with attachment capability on all sides
- You can find more technical data about the material, chemical resistance, temperatures ► [chapter Design, page 1.38](#)

Selection table

Series	Inner height <i>hi</i> [mm]	Inner width <i>Bi</i> [mm]	Outer width <i>Ba</i> [mm]	Outer height <i>ha</i> [mm]	Bending radius <i>R</i> [mm]	Unsupported length max. [m]	Page
R117/118	21	20-100	32-112	28	63 - 180	1,20	6.6
R157/158	40	40-200	56-216	50	100 - 250	2,25	6.12
R167/168	50	50-250	68-268	64	100 - 300	2,50	6.20

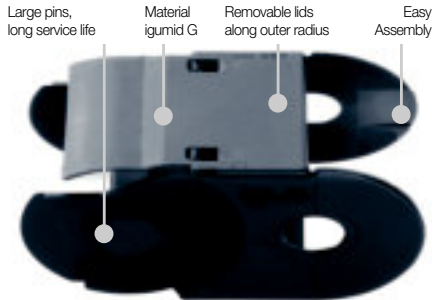

E2 Series R - small pitch for smooth motion

- Protection for cables and hoses against chips (also hot chips)
- Small pitch for low noise, smooth operation
- Smooth, chip repellent exterior
- Lids removable for assembly time reduction
- Double stop dog for strong unsupported lengths
- KMA mounting brackets with attachment capability on all sides
- Very small radii possible due to small pitch
- You can find more technical data about the material, chemical resistance, temperatures ► [chapter Design, page 1.38](#)

Selection table

Series	Inner height <i>hi</i> [mm]	Inner width <i>Bi</i> [mm]	Outer width <i>Ba</i> [mm]	Outer height <i>ha</i> [mm]	Bending radius <i>R</i> [mm]	Unsupported length max. [m]	Page
R48	25	25-130	36-141	36	60 - 250	1,50	6.26
R58	35	50-200	66-216	50	75 - 250	2,30	6.34
R68	45	50-250	68-268	64	100 - 300	2,50	6.42

Type R100 | Series R117/R118 · R157/R158 · R167/R168

Assembling | Type R100



1 Push, click - and snap in pin



2 Swivel lids - push and snap

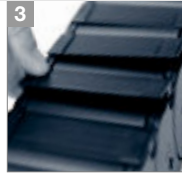

3 Slide last lid

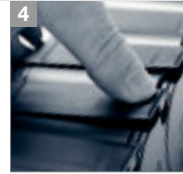

4 Push and snap

Separating | Type R100

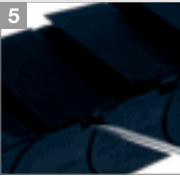

5 Lever open lid



6 Bend E-Tube to remove lid



7 Release side-link



8 Twist and pull apart

Type R | Series R48 · R58 · R68

Assembling | Type R



1 Push and click



2 Snap in pin

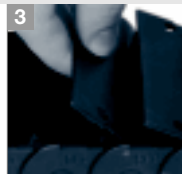

3 Slide lid



4 Push and snap

Separating | Type R



5 Lever open lid

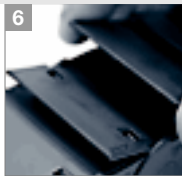

6 Remove lid

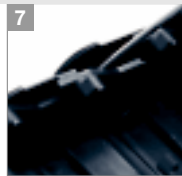

7 Release side-link



8 Twist and pull apart



● ● ● Price index

UL94-V2 classifications upon request

ESD classification: Electrically conductive ESD/ATEX version upon request

iF-Design Award Winner Series R117/R118

E-Tubes with HT-material for hot chips up to 850°C available upon request



To open the E-Tube Series R100 lift up the lid and swivel lid to the side

- ① Effective chip protection, even against hot metal chips
- ② Smooth, chip-repellent exterior
- ③ Double stop dog for strong unsupported length
- ④ Snap-open from the side, covered pin/bore connection
- ⑤ Lateral glide surfaces for side-mounted operation
- ⑥ Snap-open lids along inner or outer radius
- ⑦ Universal KMA mounting brackets with attachment capability on all sides
- ⑧ Space-efficient with optimized ratio of inner dimension to outer dimension



When to use the Series R117/R118:

- If snap-open accessibility along inner or outer radius is required
- If price is an issue
- If flush attachment is required



When not to use it:

- For smoother running and smaller pitch
 - ▶ E-Tubes E2, Series R48, page 6.26



Order example complete E-Tube

Please indicate E-Tube-lengths or number of links **Example: 1 m or 33 links**

1 m **117.100.100.0**

E-Tube

with 2 separators **1186.01** assembled every 2nd link

Interior separation

1 set **11800.100.14**

Mounting bracket



Unsupported length

FL_G = with straight upper run

FL_B = with permitted sag

Further information ► **Design, page 1.12**

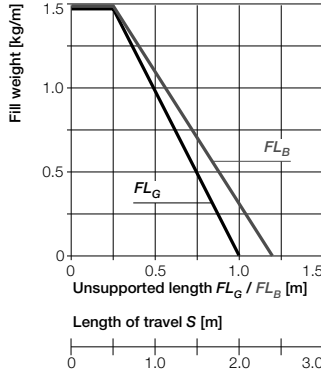
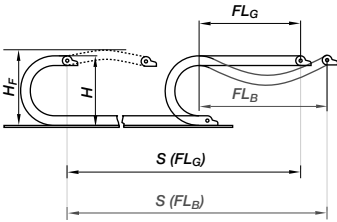

- S = Length of travel
- R = Bending radius
- H = Nominal clearance height
- H_F = Required clearance height
- D = Overlength E-Chain*
radius in final position
- $K = \pi \cdot R + \text{"safety"}$

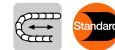
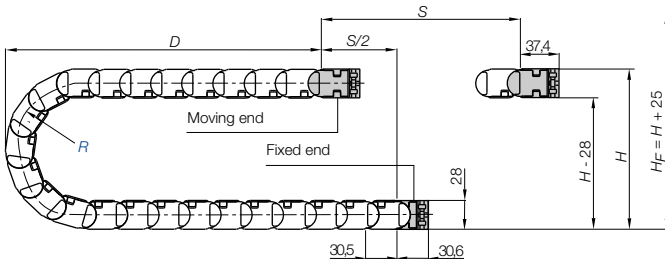

Short travels - unsupported

Unsupported E-Chains* feature positive camber over short travels. This must be accounted for when specifying the clearance height H_F . Please consult igus* if space is particularly restricted.

Pitch = 30,5 mm/link Links/m = 33 (1000,6 mm) Chain length = $S/2 + K$

R	063	075	100	110	125	145	180
H	154	178	228	248	278	318	388
D	110	120	145	155	170	190	225
K	260	300	375	410	455	520	630

The required

clearance height:

$H_F = H + 25$ mm

(with 1,0 kg/m fill weight)

Hot Chips up to 850°C

E-Tubes that repel hot chips, up to 850°C. Some applications, depending on amount and size of the chips, can burn or melt the surface. That is no longer the case with the igus® "igumid HT" material.

Order example - Full E-Tube made of HT*: 118.080.100.0.HT

Order example - Lids made of HT: 118.080HT.100.0

*for long travels upon request

Delivery time up to 4 weeks! Further Information: www.igus.de/en/HT

Speed / acceleration FL_G	max. 10 [m/s] / max. 100 [m/s²]
Speed / acceleration FL_B	max. 3 [m/s] / max. 6 [m/s²]
Gliding speed / acceleration (maximum)	max. 0,5 [m/s] / max. 5 [m/s²]
Material - permitted temperature °C	igumid G / -40° up to +120° C
Flammability class, igumid G	VDE 0304 IIC UL94 HB

Technical Data



Details of material properties

► page 1.38



E2 E-Tubes Type R
Inner height: 21 mm

Phone +49- (0) 22 03-96 49-800
Fax +49- (0) 22 03-96 49-222



► page 6.5

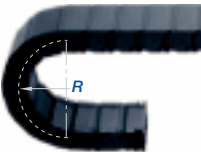
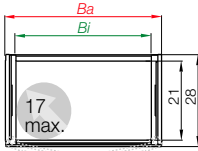

Part No. structure

117. 100. 100. 0



Series R117 - hinged, snap-open on both sides of the inner radius

Part No.	Bi [mm]	Ba [mm]	R [mm]	Bending radii						Weight [kg/m]
117.020.□.0	20	32	063	075	100	110	125	145	180	≈ 0,43
117.025.□.0	25	37	063	075	100	110	125	145	180	≈ 0,46
117.038.□.0	38	50	063	075	100	110	125	145	180	≈ 0,56
117.048.□.0	48	60	063	075	100	110	125	145	180	≈ 0,66
117.063.□.0	63	75	063	075	100	110	125	145	180	≈ 0,76
117.080.□.0	80	92	063	075	100	110	125	145	180	≈ 0,89
117.100.□.0	100	112	063	075	100	110	125	145	180	≈ 1,06

Supplement Part No. with required radius. Example: 117.100.100.0

0 = standard color, other colors ▶ page 1.39 · Pitch = 30,5 mm/link - Links/m = 33

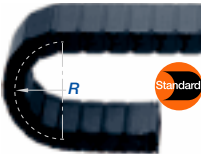
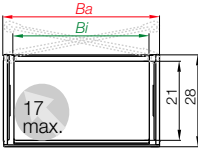

Part No. structure

118. 080. 100. 0



Series R118 - hinged, snap-open on both sides of the outer radius

Part No.	Bi [mm]	Ba [mm]	R [mm]	Bending radii						Weight [kg/m]
118.020.□.0	20	32	063	075	100	110	125	145	180	≈ 0,43
118.025.□.0	25	37	063	075	100	110	125	145	180	≈ 0,46
118.038.□.0	38	50	063	075	100	110	125	145	180	≈ 0,56
118.048.□.0	48	60	063	075	100	110	125	145	180	≈ 0,66
118.063.□.0	63	75	063	075	100	110	125	145	180	≈ 0,76
118.080.□.0	80	92	063	075	100	110	125	145	180	≈ 0,89
118.100.□.0	100	112	063	075	100	110	125	145	180	≈ 1,06

The sizes 020 / 038 / 063 / 100 are available upon request.

Delivery time: approx. 8-10 weeks after receipt of order

Supplement Part No. with required radius. Example: 118.080.100.0

0 = standard color, other colors ▶ page 1.39 · Pitch = 30,5 mm/link - Links/m = 33



Series R117·R118 | Accessories | Interior Separation

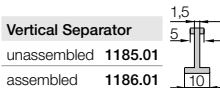

Option 1: Vertical Separators

Vertical Separators are used if a vertical subdivision of the E-Chain® interior is required -

By standard Vertical Separators are assembled every other E-Chain® link

● Standard subdivision with Vertical Separator 1185.01

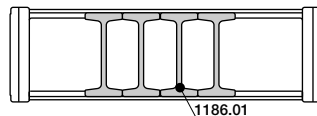

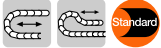

Option KMA* - pivoting

- Pivoting
- Short and long travels
- Space-restricted
- Corrosion-resistant
- Pivoting option at fixed end available upon request (Part No. 11800...12)

*KMA = Polymer Metal Mounting Bracket

Moving end (outer link)
11800...1

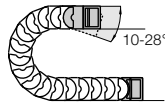

11800...4

Fixed end (inner link)

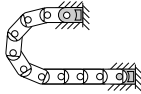

Mounting bracket attachment

11800...4
Fixed end

11800...1
Moving end

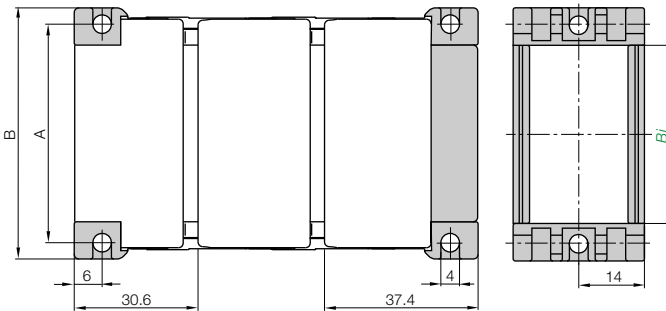

Dimensions and order configurations



The mounting brackets are supplied with hexagon nuts and can be attached with M4 bolts, or the mounting brackets may also be attached with M4 socket head cap bolts.

Part No. structure

11800.020.14 A

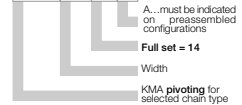

Full set, for both ends:

11800.020.14

Single-part order:

11800.020.1

Mounting bracket with bore

11800.020.4

Mounting bracket with pin

For Series	Part No. full set	Dim. A [mm]	Dim. B [mm]
117-118.020. ▶	11800.020.14	29	36
117-118.025. ▶	11800.025.14	34	41
117-118.038. ▶	11800.038.14	47	54
117-118.048. ▶	11800.048.14	57	64
117-118.063. ▶	11800.063.14	72	79
117-118.080. ▶	11800.080.14	89	96
117-118.100. ▶	11800.100.14	109	116

Please add the Part No. with the requested index - e.g. 11800.048.14

For the preassembled mode please add the index A e.g. 11800.048.14 A

Phone +49- (0) 22 03-96 49-800
Fax +49- (0) 22 03-96 49-222



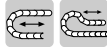

Angled polymer bracket

- Locked connection to E-Tube
- Minimized external width
- For long travels
- Attachment option for strain relief tiwrap plate

Moving end (outer link)

1180...1PZ(B)

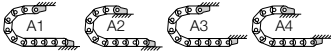
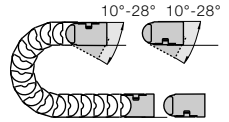

Possible installation conditions for assembled mounting brackets ▶ Order example "preassembled" below

1180...4PZ(B) Fixed end (inner link)

Dimensions and order configurations

Strain relief is possible on the moving end and/or the fixed end.

1180...1PZ(B)
Moving end

1180 ...4PZ(B)
Fixed end

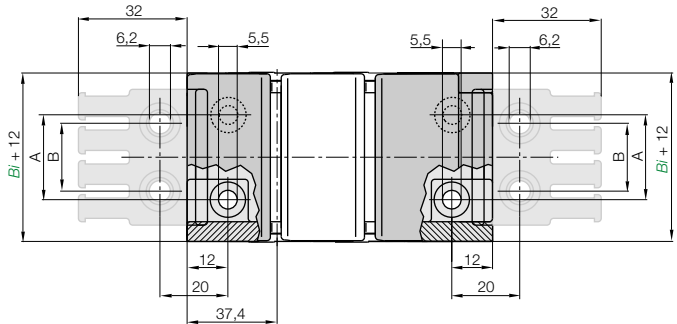

Phone +49- (0) 22 03-96 49-800
Fax +49- (0) 22 03-96 49-222

igus® GmbH
51147 Cologne

Part No. structure

1180.048.14.PZB.A1

A... must be indicated on preassembled configurations with assembled tiwrap plates
Full set = 14
Width
Mounting brackets for selected chain type

Full set, for both ends:

1180.048.14.PZB+tiwrap plate

Single-part order:

1180.048.1.PZB+tiwrap plate

Mounting bracket with bore

1180.048.4.PZB+tiwrap plate

Mounting bracket with pin

For Series	Part No. full set with tiwrap plate	Part No. full set without tiwrap plate	Dim. A [mm]	Dim. B [mm]
117-118.025. ▶	1180.025.14PZB	1180.025.14PZ	12	15
117-118.038. ▶	1180.038.14PZB	1180.038.14PZ	25	20
117-118.048. ▶	1180.048.14PZB	1180.048.14PZ	35	30
117-118.063. ▶	1180.063.14PZB	1180.063.14PZ	50	40
117-118.080. ▶	1180.080.14PZB	1180.080.14PZ	67	60
117-118.100. ▶	1180.100.14PZB	1180.100.14PZ	87	80

Please add the Part No. with the requested index - e.g. 1180.048.12.PZB

For the preassembled mode please add the index A1...A4, e.g. 1180.048.12PZB.A1

The following parts are required for attachment of the mounting brackets:

- Countersunk bolt M5 DIN 912-8.8 Length depends on the thickness of the attachment base
- Hexagon nut M5 DIN 934-8

Internet: www.igus.eu
E-mail: info@igus.de

Tiewrap plate	No. of teeth <i>n</i>	Dim. C [mm]	Dim. B [mm]
2020.ZB	3	30	15
2030.ZB	4	40	20
2040.ZB	5	50	30
2050.ZB	6	60	40
2070.ZB	8	80	60
2090.ZB =			
(2030.ZB + 2040.ZB)	9	90	-
2100.ZB	10	100	80
2125.ZB =			
(2050.ZB + 2050.ZB)	12	120	-

Tiewrap plate as individual part

As individual component screwed on KMA. Can be plugged in the mounting brackets. **Details ▶ chapter 10**

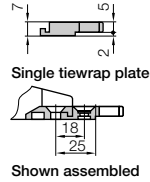
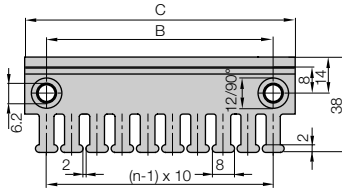

E2 E-Tubes Type R
Inner height: 21 mm

Cable tiewraps as individual part

Cable tiewraps (100-piece bag)	Width x length	max. Ø	Tensile strength
CFB.001	4,8 x 150 mm	36 mm	222 N



Other strain relief elements
▶ chapter 10

Phone +49- (0) 22 03-96 49-800
Fax +49- (0) 22 03-96 49-222



▶ chapter 10



▶ page 6.5

● ● ● Price index

UL94-V2 classifications upon request

ESD classification: Electrically conductive ESD/ATEX version upon request

E-Tubes with HT-material for hot chips up to 850°C available upon request

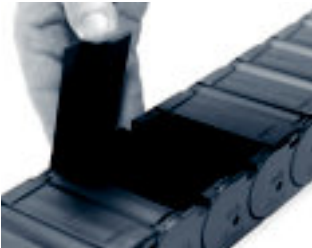

To open the E-Tube Series R100 lift up the lid and swivel lid to the side

When to use the Series R157/R158:

- If snap-open accessibility along inner or outer radius is required
- If a low-cost, lightweight E-Tube for many types of applications required
- If flush attachment is required
- If chip-repellent features are required

When not to use it:

- If snap-open accessibility along both sides is required
▶ **System E4.1, Series R4.32, page 7.34**
- If very smooth travel due to small pitch is required
▶ **Type R, Series R58, page 6.34**

- 1 Snap-open lids along inner or outer radius
- 2 Snap-open from the side, covered pin/bore connection
- 3 Effective chip protection, even against hot metal chips
- 4 Double stop dog for strong unsupported length
- 5 Lateral glide surfaces for side-mounted operation
- 6 Universal KMA mounting brackets with attachment capability on all sides
- 7 Space-efficient with optimized ratio of inner dimension to outer dimension
- 8 **Strain relief separator** - Separator with integrated strain relief for the use in the first or last chain link ▶ **page 6.18**



Order example complete E-Tube

Please indicate E-Tube-lengths or number of links **Example: 1 m or 22 links**

1 m 157.088.100.0

E-Tube

with 2 separators 1586.01 assembled every 2nd link

Interior separation

1 set 15800.088.12

Mounting bracket



Unsupported length

FL_G = with straight upper run

FL_B = with permitted sag

Further information ► Design, page 1.12

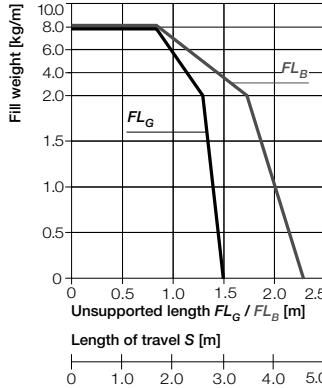
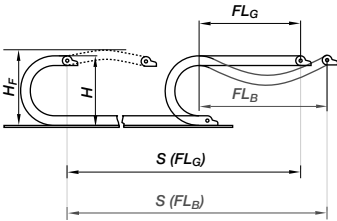

- S = Length of travel
- R = Bending radius
- H = Nominal clearance height
- H_f = Required clearance height
- D = Overlength E-Chain[®] radius in final position
- $K = \pi \cdot R + \text{"safety"}$

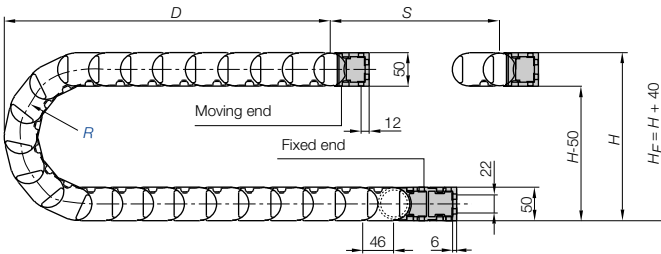

Short travels - unsupported

Unsupported E-Chains[®] feature positive camber over short travels. This must be accounted for when specifying the clearance height H_f . Please consult igus[®] if space is particularly restricted.

Pitch = 46 mm/link Links/m = 22 (1012 mm) Chain length = $S/2 + K$

R	100	125	150	175	200	250
H	250	300	350	400	450	550
D	175	200	225	250	275	325
K	410	485	565	645	725	880

The required clearance height:
 $H_f = H + 40$ mm
(with 1,0 kg/m fill weight)

Hot Chips up to 850°C

E-Tubes that repel hot chips, up to 850 °C. Some applications, depending on amount and size of the chips, can burn or melt the surface. That is no longer the case with the igus[®] "igumid HT" material.

Order example - Full E-Tube made of HT*: **158.100.100.0.HT**

Order example - Lids made of HT: **158.100HT.100.0**

*for long travels upon request

Delivery time up to 4 weeks! Further Information: www.igus.de/en/HT

Technical Data

Speed / acceleration FL_G	max. 10 [m/s] / max. 100 [m/s ²]
Speed / acceleration FL_B	max. 3 [m/s] / max. 6 [m/s ²]
Gliding speed / acceleration (maximum)	max. 0,5 [m/s] / max. 5 [m/s ²]
Material - permitted temperature °C	igumid G / -40° up to +120° C
Flammability class, igumid G	VDE 0304 IIC UL94 HB



Details of material properties
► page 1.38



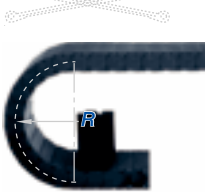
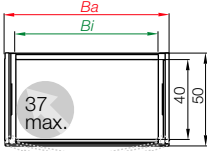

Part No. structure

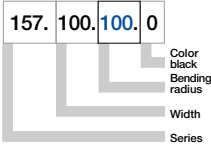

Series R157 - hinged, snap-open on both sides of the inner radius

Part No.	Bi [mm]	Ba [mm]	R [mm]	Bending radii						Weight [kg/m]
157.040.□.0*	40	56	100	125	150	175	200	250	≈ 1,21	
157.050.□.0	50	66	100	125	150	175	200	250	≈ 1,30	
157.075.□.0	75	91	100	125	150	175	200	250	≈ 1,50	
157.088.□.0	88	104	100	125	150	175	200	250	≈ 1,57	
157.090.□.0**	88	104	100	125	150	175	200	250	≈ 1,63	
157.100.□.0	100	116	100	125	150	175	200	250	≈ 1,71	
157.125.□.0	125	141	100	125	150	175	200	250	≈ 1,92	
157.135.□.0	135	150	100	125	150	175	200	250	≈ 2,10	
157.150.□.0	150	166	100	125	150	175	200	250	≈ 2,13	
157.175.□.0	175	191	100	125	150	175	200	250	≈ 2,34	
157.200.□.0	200	216	100	125	150	175	200	250	≈ 2,55	

* Lid removable only, not hinged

** Same dimensions as 157.088 - less recent design, no hinged option

Supplement Part No. with required radius. Example: 157.100.100.0

0 = standard color, other colors ▶ page 1.39 · Pitch = 46 mm/link - Links/m = 22

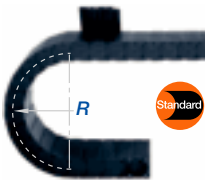
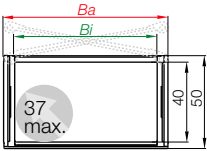

Part No. structure

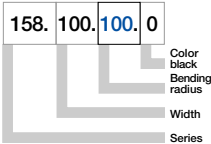

Series R158 - hinged, snap-open on both sides of the outer radius

Part No.	Bi [mm]	Ba [mm]	R [mm]	Bending radii						Weight [kg/m]
158.040.□.0*	40	56	100	125	150	175	200	250	≈ 1,21	
158.050.□.0	50	66	100	125	150	175	200	250	≈ 1,30	
158.075.□.0	75	91	100	125	150	175	200	250	≈ 1,50	
158.088.□.0	88	104	100	125	150	175	200	250	≈ 1,57	
158.090.□.0**	88	104	100	125	150	175	200	250	≈ 1,63	
158.100.□.0	100	116	100	125	150	175	200	250	≈ 1,71	
158.125.□.0	125	141	100	125	150	175	200	250	≈ 1,92	
158.135.□.0	135	150	100	125	150	175	200	250	≈ 2,10	
158.150.□.0	150	166	100	125	150	175	200	250	≈ 2,13	
158.175.□.0	175	191	100	125	150	175	200	250	≈ 2,34	
158.200.□.0	200	216	100	125	150	175	200	250	≈ 2,55	

* Lid removable only, not hinged

** Same dimensions as 158.088 - less recent design, no hinged option

The size 125 is available upon request. Delivery time: approx. 8-10 weeks after receipt of order

Supplement Part No. with required radius. Example: 158.100.100.0

0 = standard color, other colors ▶ page 1.39 · Pitch = 46 mm/link - Links/m = 22



Option 1: Vertical Separators

Vertical Separators are used if a vertical subdivision of the E-Chain® interior is required - By standard Vertical Separators are assembled every other E-Chain® link

- **Standard** subdivision with Vertical Separator 1586.01
- **Asymmetrical Separator 1586.01.A** for side-mounted operations
- **Strain Relief Separator 1586.01.Z**, integrable in the mounting bracket, to position at any point - can be combined with Full-Width Shelf 221.X and Shelf 2210.X

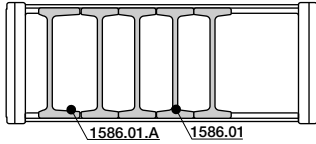

Vertical Separator

unassembled	1585.01
assembled	1586.01

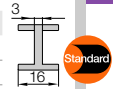

Asymmetrical Separator

unassembled	1585.01.A
assembled	1586.01.A



Strain Relief Separator

unassembled	1585.01.Z
assembled	1586.01.Z

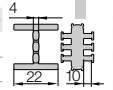

E2 E-Tubes Type R
Inner height: 40 mm

Option 2: Full-Width Shelves

For applications involving many thin cables with similar or identical diameters

- Vertical Separator, slotted 1586.02 for applications with Full-Width Shelf 221.X

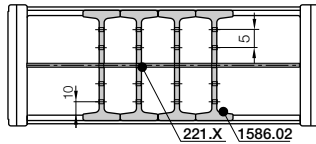

Vert. Separator, slotted

unassembled	1585.02
assembled	1586.02



Width X [mm]	Part No. unassembled	Part No. assembled
040	220.40	221.40
050	220.50	221.50
075	220.75	221.75
088	220.88	221.88
100	220.100	221.100

Width X [mm]	Part No. unassembled	Part No. assembled
125	220.125	221.125
135	220.135	221.135
150	220.150	221.150
175	220.175	221.175
200	220.200	221.200

Full-Width Shelf

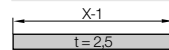

Option 3: Shelves

For applications involving many cables with similar or identical diameters. Partial separation into individual chambers can be achieved and the entire width Bt-10 mm can be used

- Shelf 2210.X can be combined with Middle Plate 1586.03

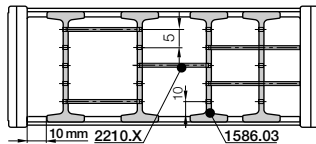

Middle Plate

unassembled	1585.03
assembled	1586.03



Width X [mm]	Part No. unassembled	Part No. assembled
018	2200.18	2210.18
023	2200.23	2210.23
028	2200.28	2210.28
033	2200.33	2210.33
038	2200.38	2210.38
043	2200.43	2210.43
048	2200.48	2210.48

Width X [mm]	Part No. unassembled	Part No. assembled
058	2200.58	2210.58
068	2200.68	2210.68
073	2200.73	2210.73
088	2200.88	2210.88
099	2200.99	2210.99
124	2200.124	2210.124
149	2200.149	2210.149

Shelf

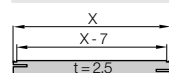

Phone +49- (0) 22 03-96 49-800
Fax +49- (0) 22 03-96 49-222



▶ page 6.5

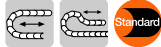

Option KMA* - pivoting, extended

- Recommended for unsupported and gliding applications
- Extended, pivoting
- Easy to install
- Universal mountable with attachment capability on all sides
- Locked connection to E-Tube
- Long travels with lowered mounting height possible

*KMA = Polymer Metal Mounting Bracket

Moving end (outer link)

15800/15801 ...1

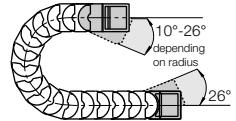

15800/15801...2

Fixed end (inner link)

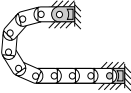

The attachment variants arising automatically by the choice of the KMA mounting bracket

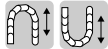

Option KMA - locking, extended

- Recommended for vertical hanging / standing applications
- Extended, locking
- Easy to install
- Flush mounting at both ends of the E-Tube
- Universal mountable with attachment capability on all sides
- Corrosion-resistant

Moving end (outer link)

15800/15801 ...3

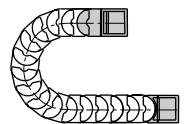

15800/15801...4

Fixed end (inner link)

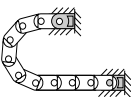

The attachment variants arising automatically by the choice of the KMA mounting bracket

Dimensions and order configurations



Quickflange upon request

Part No. structure (pivoting)

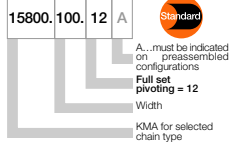

Full set, for both ends:

15800.100.12

Single-part order:

15800.100.1

Mounting bracket with bore

15800.100.2

Mounting bracket with pin

Part No. structure (locking)

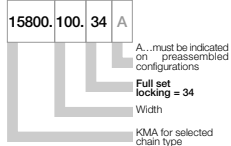

Full set, for both ends:

15800.100.34

Single-part order:

15800.100.3

Mounting bracket with bore

15800.100.4

Mounting bracket with pin

15800/15801...1 Standard! (pivoting)

15800/15801...3 (locking)

Moving end

Standard! (pivoting) 15800/15801...2

(locking) 15800/15801...4

Fixed end

Quickflange available upon request

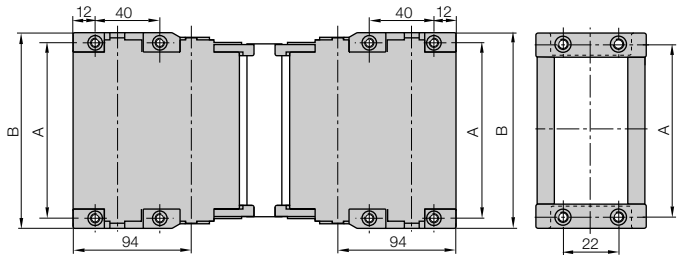

For Series	Part No. full set	Dim. A [mm]	Dim. B [mm]
157-158.040	15801.040.	50	61
157-158.050	15800.050.	60	71
157-158.075	15800.075.	85	96
157-158.088	15800.088.	98	109
157-158.090	15801.090.	98	109
157-158.100	15800.100.	110	121
157-158.125	15800.125.	135	146
157-158.135	15800.135.	145	156
157-158.150	15800.150.	160	171
157-158.175	15800.175.	185	196
157-158.200	15800.200.	210	221

Please add the Part No. with the requested index - 12 for the pivoting configuration

e.g. 15800.100.12 or 34 for the locking configuration e.g. 15800.100.34

For the preassembled mode please add the index [A] e.g. 15800.100.12 [A]

The following parts are required for attachment of the mounting brackets:

- Socket head cap bolt M5 DIN 912-8.8 Length depends on the thickness of the attachment base
- Washer 5,3 DIN 125-ST ● Hexagon nut M5 DIN 934-8



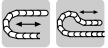

Option KMA* - pivoting, abbreviated

- Recommended for unsupported and gliding applications
 - Abbreviated, pivoting
 - Universal mountable with attachment capability on all sides
 - Locked connection to E-Tube
 - Corrosion-resistant
 - Space-restricted
- Long travels with lowered mounting height possible
*KMA = Polymer Metal Mounting Bracket

Moving end (outer link)
1580...1

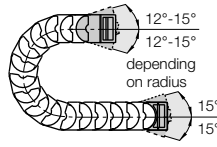

1580...2
Fixed end (inner link)



The attachment variants arising automatically by the choice of the KMA mounting bracket

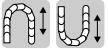
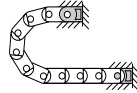

Option KMA - locking, abbreviated

- Recommended for vertical hanging / standing applications
- Abbreviated, locking
- Flush mounting at both ends of the E-Tube
- Corrosion-resistant
- Flush mounting, turned 90° at fixed end option

Moving end (outer link)
1585...1

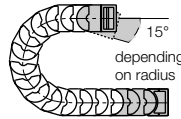

1585...2
Fixed end (inner link)



The attachment variants arising automatically by the choice of the KMA mounting bracket

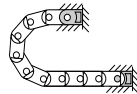

1580...1 (pivoting)

(pivoting) 1580...2

Quickflange available upon request

1585...1 (locking)

(locking) 1585...2

Moving end

Fixed end

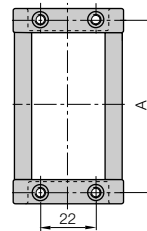
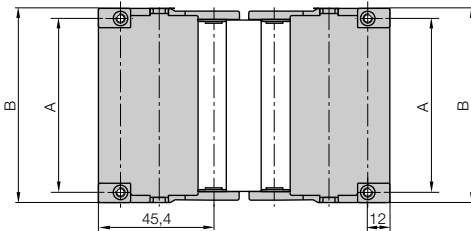

For Series	Part No. full set	Dim. A [mm]	Dim. B [mm]
157-158.040 ▶	□ .040.12	50	61
157-158.050 ▶	□ .050.12	60	71
157-158.075 ▶	□ .075.12	85	96
157-158.088 ▶	□ .088.12	98	109
157-158.090 ▶	□ .090.12	98	109
157-158.100 ▶	□ .100.12	110	121
157-158.125 ▶	□ .125.12	135	146
157-158.135 ▶	□ .135.12	145	156
157-158.150 ▶	□ .150.12	160	171
157-158.175 ▶	□ .175.12	185	196
157-158.200 ▶	□ .200.12	210	221

Please add the Part No. with the requested index - 1580 for the pivoting configuration

e.g. **1580.100.12** or 1585 for the locking configuration e.g. **1585.100.12**

For the preassembled mode please add the index **A** e.g. **1580.100.12 A**

The following parts are required for attachment of the mounting brackets:

- Socket head cap bolt M5 DIN 912-8.8 Length depends on the thickness of the attachment base
- Washer 5,3 DIN 125-ST ● Hexagon nut M5 DIN 934-8

Dimensions and order configurations



Part No. structure (pivoting)

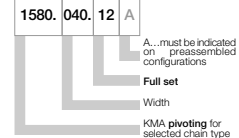

Full set, for both ends:

1580.040.12

Single-part order:

1580.040.1

Mounting bracket with bore

1580.040.2

Mounting bracket with pin

Part No. structure (locking)

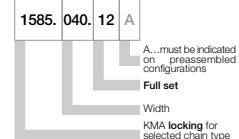

Full set, for both ends:

1585.040.12

Single-part order:

1585.040.1

Mounting bracket with bore

1585.040.2

Mounting bracket with pin



Strain relief separator for the use in the first or last chain link ▶ page 6.18



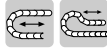

Flange mounting brackets made of steel

- Metallic flange brackets with popular hole patterns, easily be replaced by their modern successors, without having to alter the hole pattern
- Bolted connection outside of chain cross-section possible
- Universal mountable with attachment capability on all sides
- Steel, galvanized
- One-piece mounting bracket
- High stability

Moving end (outer link)
906.461.X

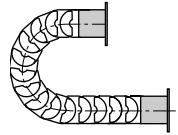

906.461.X

Fixed end (inner link)

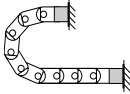

Flush mounting possibilities at both ends of the E-Tube

Dimensions and order configurations

Hole patterns flange steel mounting brackets 906.461.X

906.461.X
Moving end

906.461.X
Fixed end

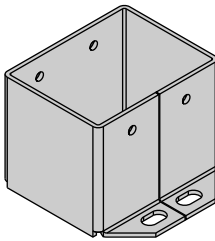

Principle sketch flange steel mounting brackets

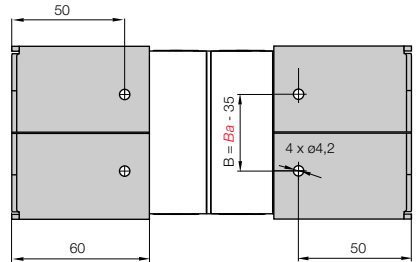
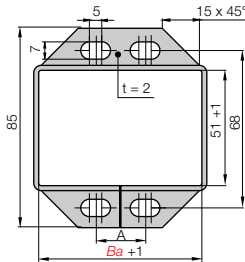

For Series	Hole pattern	Part No. full set	Bi [mm]	Ba [mm]	Dim. A [mm]	Dim. B [mm]
157-158.050 ▶	58.05	906.461.1	50	66	20	31
157-158.075 ▶	58.1	906.461.2	75	91	30	57

Phone +49- (0) 22 03-96 49-800
Fax +49- (0) 22 03-96 49-222



Mounting only with hexagon socket DIN 912 M6 and washer DIN 125, 6,3 mm

igus® GmbH
51147 Cologne

R100 | Series R157-R158 | Accessories | Strain Relief

Strain relief separator

Separator with integrated strain relief, for use in the first or last chain link. For manufacturing of switchgear cabinets or for the assembly of machines. Easy to assemble without any fastening device. Separator base **1585.01.Z** is 22 mm wide. The possible number of separators per E-Chain® is defined by its inner width *Bi* and by the cable-diameter. **Details ▶ chapter 10**

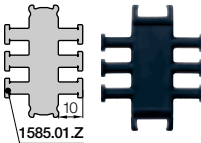

Part No.	Number of teeth	For Series
1585.01.Z	3 both sides	R157/158 E-Tube

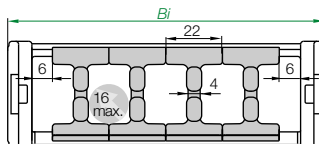

Strain Relief Separator - The number of separators is depending on the cables and the available inner space. Example: E-Chain® inner width *Bi* 100 mm: 4 Strain Relief Separator, max. cable diameter 16 mm. **Details ▶ chapter 10**



Other strain relief elements
▶ chapter 10

Internet: www.igus.eu
E-mail: info@igus.de



E2 E-Tubes side-mounted and unsupported in a chip area



igus® E-Tubes protect your cables and are easy to open

E2 E-Tubes Type R
Inner height: 40 mm

Phone +49- (0) 22 03-96 49-800
Fax +49- (0) 22 03-96 49-222



▶ chapter 10



▶ page 6.5



Price index



UL94-V2 classifications upon request



ESD classification:
Electrically conductive
ESD/ATEX version upon request



E-Tubes with HT-material for hot chips up to 850°C available upon request

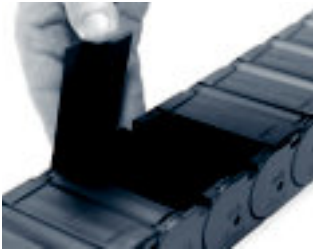

To open the E-Tube Series R100 lift up the lid and swivel lid to the side



When to use the Series R167/R168:

- If snap-open accessibility along inner or outer radius is required
- If a low-cost, lightweight E-Tube for many types of applications required
- If flush attachment is required
- If chip-repellent features are required



When not to use it:

- If snap-open accessibility along both sides is required
▶ System E4.1, Series R4.42, page 7.48
- If very smooth travel due to small pitch is required
▶ Type R, Series R68, page 6.42

- ❶ Double stop dog for strong unsupported length
- ❷ Effective chip protection, even against hot metal chips
- ❸ Covered pin/bore connection
- ❹ Lateral glide surfaces for side-mounted operation
- ❺ Snap-open lids along inner or outer radius
- ❻ Lids can be swivelled from the left to the right
- ❼ Space-efficient with optimized ratio of inner dimension to outer dimension
- ❽ Universal KMA mounting brackets with attachment capability on all sides
- ❾ Strain relief separator - Separator with integrated strain relief for the use in the first or last chain link ▶ page 6.25

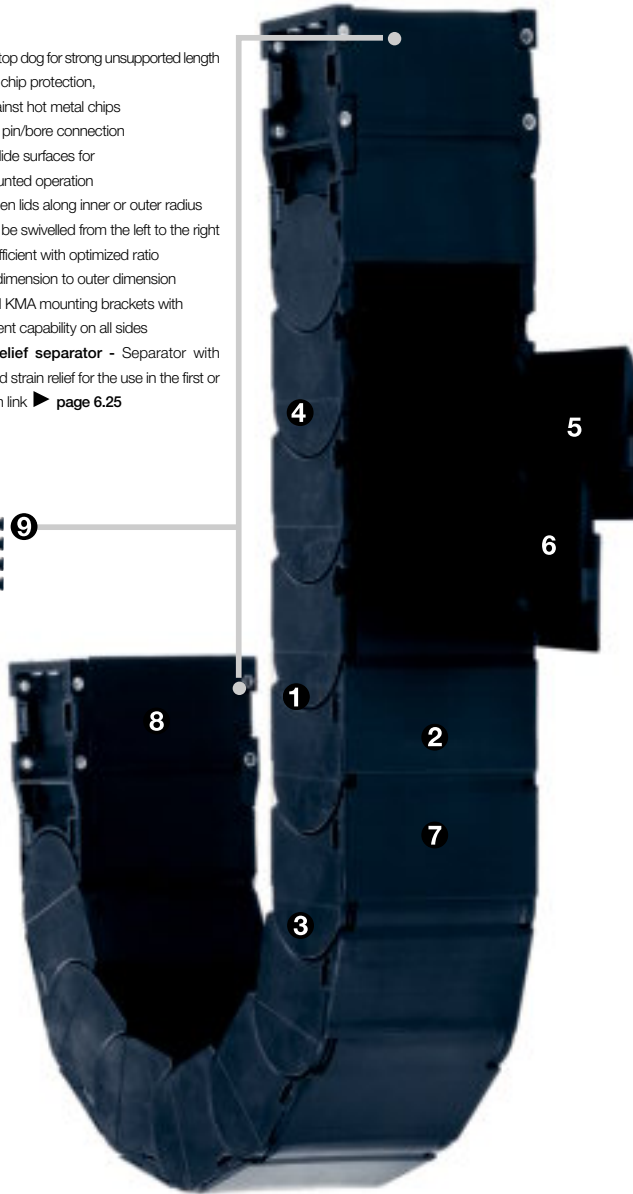

Order example complete E-Tube

Please indicate E-Tube-lengths or number of links Example: 1 m or 17 links

1 m 167.100.100.0

E-Tube

with 2 separators 1686.01 assembled every 2nd link

Interior separation

1 set 1680.100.12

Mounting bracket



Unsupported length

FL_G = with straight upper run

FL_B = with permitted sag

Further information ► **Design, page 1.12**

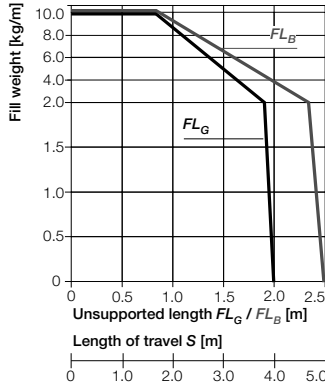
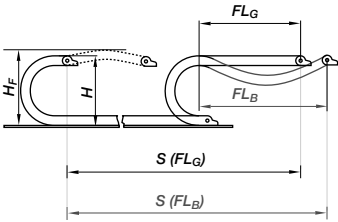

- S = Length of travel
- R = Bending radius
- H = Nominal clearance height
- H_F = Required clearance height
- D = Overlength E-Chain[®] radius in final position
- $K = \pi \cdot R + \text{"safety"}$

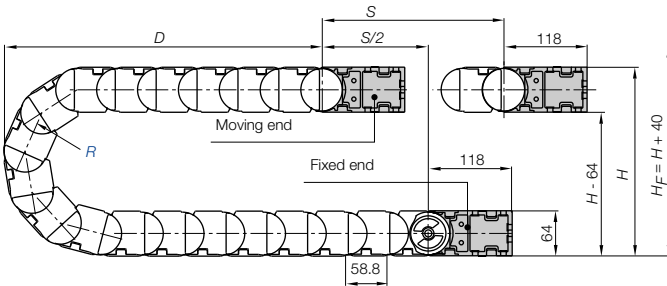

Short travels - unsupported

Unsupported E-Chains[®] feature positive camber over short travels. This must be accounted for when specifying the clearance height H_F . Please consult igus[®] if space is particularly restricted.

Pitch = 58,8 mm/link Links/m = 17 (999,6 mm) Chain length = $S/2 + K$

R	100	125	150	175	200	225	250	300
H	264	314	364	414	464	514	564	664
D	180	205	230	255	280	305	330	380
K	440	510	590	670	750	830	910	1060

The required clearance height:
 $H_F = H + 40 \text{ mm}$
(with 2,0 kg/m fill weight)

E2 E-Tubes Type R
Inner height: 50 mm

Phone +49- (0) 22 03-96 49-800
Fax +49- (0) 22 03-96 49-222



Hot Chips up to 850°C

E-Tubes that repel hot chips, up to 850°C. Some applications, depending on amount and size of the chips, can burn or melt the surface. That is no longer the case with the igus[®] "igumid HT" material.

Order example - Full E-Tube made of HT*: 168.100.100.0.HT

Order example - Lids made of HT: 168.100HT.100.0

*for long travels upon request

Delivery time up to 4 weeks! Further Information: www.igus.de/en/HT

Technical Data

Speed / acceleration FL_G	max. 10 [m/s] / max. 100 [m/s ²]
Speed / acceleration FL_B	max. 3 [m/s] / max. 6 [m/s ²]
Gliding speed / acceleration (maximum)	max. 0,5 [m/s] / max. 5 [m/s ²]
Material - permitted temperature °C	igumid G / -40° up to +120° C
Flammability class, igumid G	UDE 0304 IIC UL94 HB



Details of material properties
► page 1.38



► page 6.5

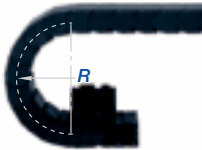
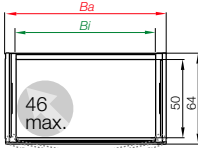

Part No. structure

167. 100. 100. 0



Series R167 - hinged, snap-open on both sides of the inner radius

Part No.	Bi (mm)	Ba (mm)	R (mm)	Bending radii								Weight [kg/m]
167.050.□.0	50	68	100	125	150	175	200	225	250	300	≈ 1,58	
167.075.□.0	75	93	100	125	150	175	200	225	250	300	≈ 1,84	
167.100.□.0	100	118	100	125	150	175	200	225	250	300	≈ 2,09	
167.115.□.0	115	133	100	125	150	175	200	225	250	300	≈ 2,24	
167.125.□.0	125	143	100	125	150	175	200	225	250	300	≈ 2,35	
167.150.□.0	150	168	100	125	150	175	200	225	250	300	≈ 2,60	
167.175.□.0	175	193	100	125	150	175	200	225	250	300	≈ 2,86	
167.200.□.0	200	218	100	125	150	175	200	225	250	300	≈ 3,11	
167.225.□.0	225	243	100	125	150	175	200	225	250	300	≈ 3,37	
167.250.□.0	250	268	100	125	150	175	200	225	250	300	≈ 3,62	

Supplement Part No. with required radius. Example: 167.100.100.0

0 = standard color, other colors ▶ page 1.39 · Pitch = 58,8 mm/link - Links/m = 17

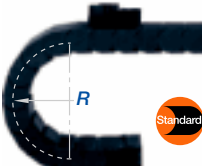
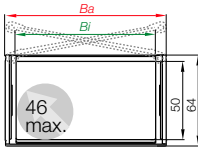

Part No. structure

168. 100. 100. 0



Series R168 - hinged, snap-open on both sides of the outer radius

Part No.	Bi (mm)	Ba (mm)	R (mm)	Bending radii								Weight [kg/m]
168.050.□.0	50	68	100	125	150	175	200	225	250	300	≈ 1,58	
168.075.□.0	75	93	100	125	150	175	200	225	250	300	≈ 1,84	
168.100.□.0	100	118	100	125	150	175	200	225	250	300	≈ 2,09	
168.115.□.0	115	133	100	125	150	175	200	225	250	300	≈ 2,24	
168.125.□.0	125	143	100	125	150	175	200	225	250	300	≈ 2,35	
168.150.□.0	150	168	100	125	150	175	200	225	250	300	≈ 2,60	
168.175.□.0	175	193	100	125	150	175	200	225	250	300	≈ 2,86	
168.200.□.0	200	218	100	125	150	175	200	225	250	300	≈ 3,11	
168.225.□.0	225	243	100	125	150	175	200	225	250	300	≈ 3,37	
168.250.□.0	250	268	100	125	150	175	200	225	250	300	≈ 3,62	

The sizes 125 / 225 / 250 are available upon request. Delivery time: approx. 8-10 weeks after receipt of order

Supplement Part No. with required radius. Example: 168.100.100.0

0 = standard color, other colors ▶ page 1.39 · Pitch = 58,8 mm/link - Links/m = 17



Option 1: Vertical Separators

Vertical Separators are used if a vertical subdivision of the E-Chain® interior is required - By standard Vertical Separators are assembled every other E-Chain® link

- Standard subdivision with Vertical Separator 1686.01
- Strain Relief Separator 1686.01.Z, integrable in the mounting bracket, to position at any point - can be combined with Full-Width Shelf 321.X and Shelf 2210.X

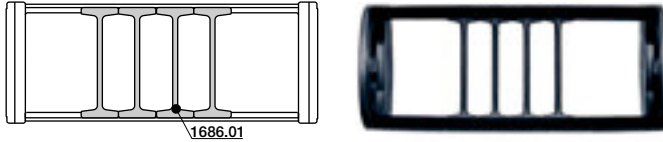

Vertical Separator	
unassembled	1685.01
assembled	1686.01

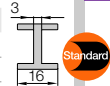

Strain Relief Separator	
unassembled	1685.01.Z
assembled	1686.01.Z

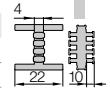

E2 E-Tubes Type R
Inner height: 50 mm

Option 2: Full-Width Shelves

For applications involving many thin cables with similar or identical diameters

- Vertical Separator, slotted 1686.02 for applications with Full-Width Shelf 321.X



Vert. Separator, slotted	
unassembled	1685.02
assembled	1686.02



Width X [mm]	Part No. unassembled	Part No. assembled
050	320.050	321.050
075	320.075	321.075
100	320.100	321.100
115	320.115	321.115
125	320.125	321.125

Width X [mm]	Part No. unassembled	Part No. assembled
150	320.150	321.150
175	320.175	321.175
200	320.200	321.200
225	320.225	321.225
250	320.250	321.250

Full-Width Shelf

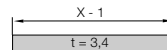

Phone +49- (0) 22 03-96 49-800
Fax +49- (0) 22 03-96 49-222

Option 3: Shelves

For applications involving many cables with similar or identical diameters. Partial separation into individual chambers can be achieved and the entire width B_i-10 mm can be used

- Shelf 2210.X can be combined with Middle Plate 1686.03 and Side Plate 1686.04

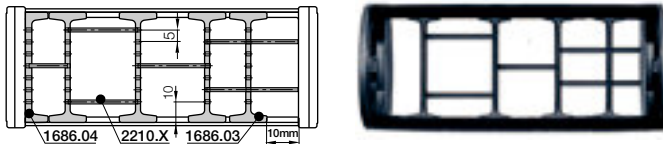

Middle Plate	
unassembled	1685.03
assembled	1686.03



Side Plate	
unassembled	1685.04
assembled	1686.04



Width X [mm]	Part No. unassembled	Part No. assembled
018	2200.18	2210.18
023	2200.23	2210.23
028	2200.28	2210.28
033	2200.33	2210.33
038	2200.38	2210.38
043	2200.43	2210.43
048	2200.48	2210.48

Width X [mm]	Part No. unassembled	Part No. assembled
058	2200.58	2210.58
068	2200.68	2210.68
073	2200.73	2210.73
088	2200.88	2210.88
099	2200.99	2210.99
124	2200.0124	2210.124
149	2200.0149	2210.149

Shelf

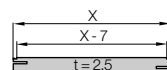

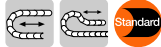

Option KMA* - pivoting

- Recommended for unsupported and gliding applications
 - Option - KMA with Quickflange, bolted connection outside of E-Tube cross-section
 - Universal mountable with attachment capability on all sides
 - Locked connection to E-Tube
 - Long travels with lowered mounting height possible
 - Corrosion-resistant
- *KMA = Polymer Metal Mounting Bracket

Moving end (outer link)
1680...1

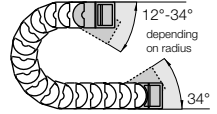

1680...2

Fixed end (inner link)

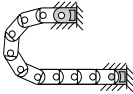

The attachment variants arising automatically by the choice of the KMA mounting bracket

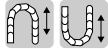

Option KMA - locking

- Recommended for vertical hanging / standing applications
- Option - KMA with Quickflange, bolted connection outside of E-Tube cross-section
- At very high speed and acceleration
- Universal mountable with attachment capability on all sides
- Flush mounting at both ends of the E-Tube

Moving end (outer link)
1680...1

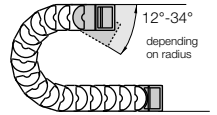

1680...4

Fixed end (inner link)

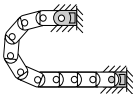

The attachment variants arising automatically by the choice of the KMA mounting bracket

Dimensions and order configurations



Quickflange upon request

Part No. structure (pivoting)

1680.100.12 A

- A... must be indicated on preassembled configurations
- Full set pivoting = 12
- Width
- KMA for selected chain type

Full set, for both ends:

1680.100.12

Single-part order:

1680.100.1

Mounting bracket with bore

1680.100.2

Mounting bracket with pin

Part No. structure (locking)

1680.100.14 A

- A... must be indicated on preassembled configurations
- Full set locking = 14
- Width
- KMA for selected chain type

Full set, for both ends:

1680.100.14

Single-part order:

1680.100.1

Mounting bracket with bore

1680.100.4

Mounting bracket with pin

Quickflange

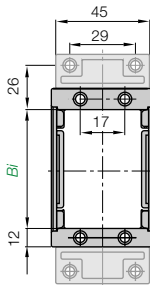

1680...1 Standard! (pivoting)

1680...1 (locking)

Moving end

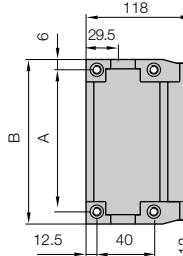

Standard! (pivoting) 1680...2

(locking) 1680...4

Fixed end

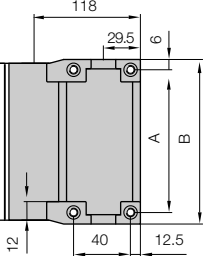

For Series	Part No.	Part No. full set with Quickflange	Dim. A [mm]	Dim. B [mm]
167-168.050	1680.050.	1680.050. QF	62	74
167-168.075	1680.075.	1680.075. QF	87	99
167-168.100	1680.100.	1680.100. QF	112	124
167-168.115	1680.115.	1680.115. QF	127	139
167-168.125	1680.125.	1680.125. QF	137	149
167-168.150	1680.150.	1680.150. QF	162	174
167-168.175	1680.175.	1680.175. QF	187	199
167-168.200	1680.200.	1680.200. QF	212	224
167-168.225	1680.225.	1680.225. QF	237	249
167-168.250	1680.250.	1680.250. QF	262	274

Please add the Part No. with the requested index - 12 for the pivoting configuration e.g. 1680.100.12 or 14 for the locking configuration e.g. 1680.100.14

For the preassembled mode please add the index A e.g. 1680.100.12 A

Quickflange unassembled: Part No. 16800.QF

The following parts are required for attachment of the mounting brackets:

- Socket head cap bolt M5 DIN 912-8.8 Length depends on the thickness of the attachment base
- Washer 5,3 DIN 125-ST ● Hexagon nut M5 DIN 934-8



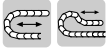

Flange mounting brackets made of steel

- Metallic flange brackets with popular hole patterns, easily be replaced by their modern successors, without having to alter the hole pattern
- Bolted connection outside of chain cross-section possible
- Universal mountable with attachment capability on all sides
- Steel, galvanized
- One-piece mounting bracket
- High stability

Moving end (outer link)
905.050.X

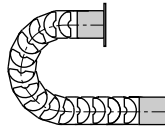

905.050.X
Fixed end (inner link)



Flush mounting possibilities at both ends of the E-Tube

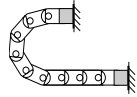

Hole patterns flange steel mounting brackets 905.050.X

905.050.X
Moving end

905.050.X
Fixed end

Dimensions and order configurations

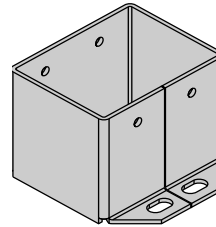
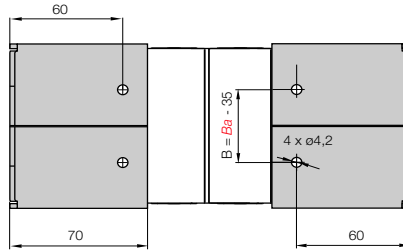
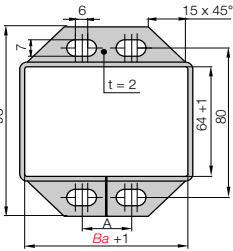

Principle sketch flange steel mounting brackets

For Series	Hole pattern	Part No. full set	Bi [mm]	Ba [mm]	Dim. A [mm]	Dim. B [mm]
R168.075	68.01	905.050.1	75	93	30	58
R168.115	68.02	905.050.2	115	133	50	98
R168.175	68.03	905.050.3	175	193	100	158



Mounting only with hexagon socket DIN 912 M6 and washer DIN 125, 6,3 mm

Phone +49- (0) 22 03-96 49-800
Fax +49- (0) 22 03-96 49-222



chapter 10



page 6.5

R100 | Serie R167-R168 | Accessories | Strain Relief

Strain relief separator

Separator with integrated strain relief, for use in the first or last chain link. For manufacturing of switchgear cabinets or for the assembly of machines. Easy to assemble without any fastening device. Separator base 1658.01.Z is 22 mm wide. The possible number of separators per E-Chain® is defined by its inner width *Bi* and by the cable-diameter. Details ► chapter 10

Part No.	Number of teeth	For Series
1658.01.Z	4 both sides	R167/168 E-Tube

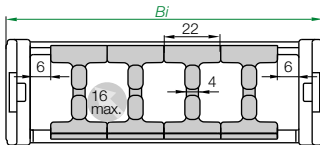
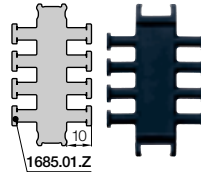

Strain Relief Separator - The number of separators is depending on the cables and the available inner space. Example: E-Chain® inner width *Bi* 100 mm: 4 Strain Relief Separator, max. cable diameter 16 mm.

Details ► chapter 10



Other strain relief elements
► chapter 10

Price index

UL94-V2 classifications upon request

 ESD classification:
Electrically conductive
ESD/ATEX version upon request

E-Tubes with HT-material for hot chips up to 850°C available upon request

- ❶ Protection for cables and hoses, against hot chips
- ❷ Removable lids along outer radius
- ❸ Large pins for high stability
- ❹ Smooth, chip-repellent exterior
- ❺ Small pitch for low-noise, smooth operation
- ❻ Fully enclosed
- ❼ KMA mounting brackets with attachment capability on all sides
- ❽ **Strain relief separator** - Separator with integrated strain relief for the use in the first or last chain link ▶ [page 6.32](#)



To open the E-Tube Series R lift up the lid (with a screwdriver) and remove the lid



When to use the Series R48:

- If particularly quiet operation is required
- At very high speed
- If chip-repellent features are required



When not to use it:

- If a particularly low-cost solution is the main factor
 - ▶ [Series R117/R118, page 6.6](#)
- If no chip protection is required
 - ▶ [Series 2400/2500 E2/000, page 5.102](#)

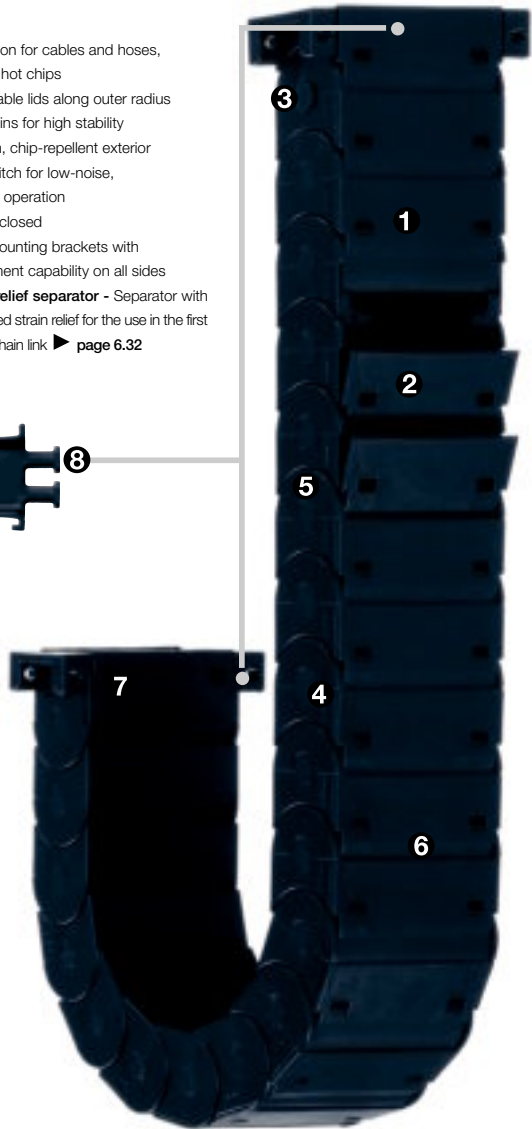

Order example complete E-Tube

Please indicate E-Tube-lengths or number of links **Example: 1 m or 33 links**

1 m **48.075.060.0**

E-Tube

with 2 separators **482** assembled every 2nd link

Interior separation

1 set **480.075.12**

Mounting bracket



Unsupported length

FL_G = with straight upper run

FL_B = with permitted sag

Further information ► **Design, page 1.12**

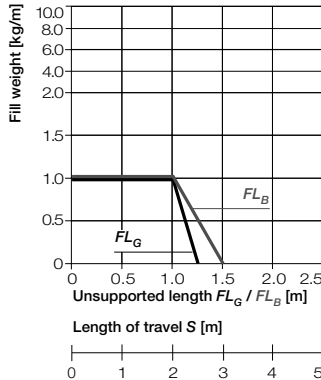
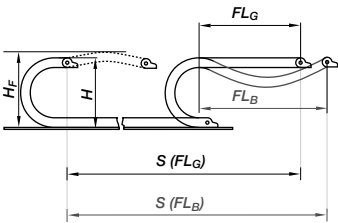

- S = Length of travel
- R = Bending radius
- H = Nominal clearance height
- H_F = Required clearance height
- H_{RI} = Trough inner height
- D = Overlength E-Chain* radius in final position
- $K = \pi \cdot R + "$ safety"
- D_2 = Overlength - long travels, gliding
- K_2 = "Further add-on
- H_2 = "Mounting height
- *if the mounting bracket location is set lower

Other installation methods

- Vertical, hanging ≤ 50 m
- Vertical, standing ≤ 4 m
- Side mounted, un supp. $\leq 1,5$ m
- Rotary requires further calculation
- Unsupported length of upper run = upon request



Short travels - unsupported

Unsupported E-Chains* feature positive camber over short travels. This must be accounted for when specifying the clearance height H_F . Please consult igus* if space is particularly restricted.

The required clearance height:
 $H_F = H + 20$ mm
 (with 0,5 kg/m fill weight)

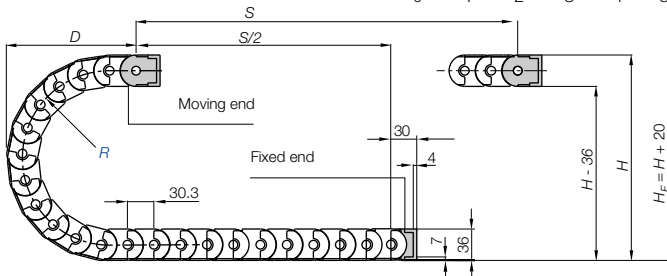

Pitch = 30,3 mm/link Links/m = 33 (999,9 mm) Chain length = $S/2 + K$

R	060	075	100	125	150	175	200	250
H	156	186	236	286	336	386	436	536
D	110	125	150	175	200	225	250	300
K	250	300	375	455	535	610	690	850
H_2	156	186	140	140	140	140	140	*
D_2	110	125	330	450	610	730	690	*
K_2	250	300	545	758	970	1151	1182	*

*upon request

Long travel lengths from 10 m to max. 50 m Chain length = $S/2 + K_2$

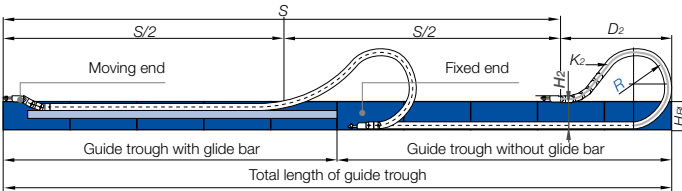

In case of travels between 4 and 10 m we recommend a longer unsupported length.



Gliding, long travel applications (max. 50 m)

In this case the E-Chain* upper run will be introduced in a guide trough on the lower run. We recommend to realize the engineering of such a plant by our technicians.

Technical Data

Speed / acceleration FL_G	max. 10 [m/s] / max. 100 [m/s ²]
Speed / acceleration FL_B	max. 3 [m/s] / max. 6 [m/s ²]
Gliding speed / acceleration (maximum)	max. 3 [m/s] / max. 10 [m/s ²]
Material - permitted temperature °C	igumid G / -40° up to +120° C
Flammability class, igumid G	VDE 0304 IIC UL94 HB



Details of material properties
 ► page 1.38

25

E2 E-Tubes Type R
 Inner height: 25 mm

Phone +49- (0) 22 03-96 49-800
 Fax +49- (0) 22 03-96 49-222



► page 6.5

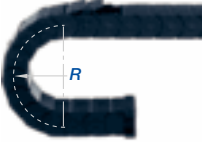
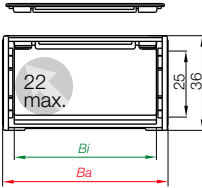

Part No. structure

48. 100. 100. 0



Series R48 - snap-open along outer radius

Part No.	Bi (mm)	Ba (mm)	R (mm)	Bending radii								Weight [kg/m]
48.025.	.0	25	36	060	075	100	125	150	175	200	250	≈ 0,64
48.050.	.0	50	61	060	075	100	125	150	175	200	250	≈ 0,84
48.075.	.0	75	86	060	075	100	125	150	175	200	250	≈ 1,03
48.100.	.0	100	111	060	075	100	125	150	175	200	250	≈ 1,23
48.130.	.0	130	141	060	075	100	125	150	175	200	250	≈ 1,46

Supplement Part No. with required radius. Example: 48.100.100.0

0 = standard color, other colors ▶ page 1.39 · Pitch = 30,3 mm/link - Links/m = 33



E2 E-Tubes | R | Series R48 | Accessories | Interior Separation

Vertical Separator

unassembled 481
 assembled 482



Strain Relief Separator

unassembled 481.ZR
 assembled 482.ZR

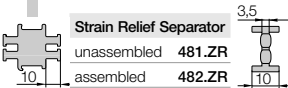

Option 1: Vertical Separators

Vertical Separators are used if a vertical subdivision of the E-Chain® interior is required -

By standard Vertical Separators are assembled every other E-Chain® link

- Standard subdivision with Vertical Separator 482
- Strain Relief Separator 482.ZR, integrable in the mounting bracket, to position at any point

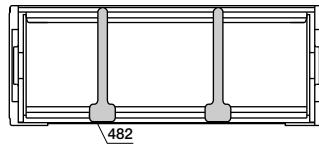

Hot Chips up to 850°C

E-Tubes that repel hot chips, up to 850 °C. Some applications, depending on amount and size of the chips, can burn or melt the surface. That is no longer the case with the igus® "igumid HT" material.

Order example - Full E-Tube made of HT*: **48.100.100.0.HT**

Order example - Lids made of HT: **48.100HT.100.0**

*for long travels upon request

Delivery time up to 4 weeks! Further Information: www.igus.de/en/HT



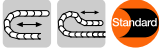

Option KMA* - pivoting

- Recommended for unsupported applications
- Bolted connection outside of chain cross-section possible
- Space-restricted
- Universal mountable with attachment capability on all sides
- Mounting-surfaces can be used on the upper side or front-sided

*KMA = Polymer Metal Mounting Bracket

Moving end (outer link)

480...1

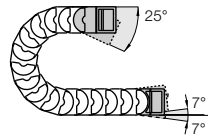

480...2

Fixed end (inner link)



The attachment variants arising automatically by the choice of the KMA mounting bracket

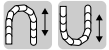
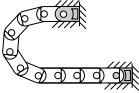

Option KMA - locking

- Recommended for vertical hanging / standing applications
- Bolted connection outside of chain cross-section possible
- At very high speed and acceleration
- Universal mountable with attachment capability on all sides
- Mounting-surfaces can be used on the upper side or front-sided

Moving end (outer link)

485...1

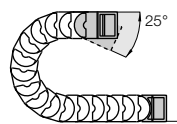

485...2

Fixed end (inner link)



The attachment variants arising automatically by the choice of the KMA mounting bracket

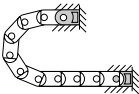

480...1 (pivoting)

485...1 (locking)

Moving end

(pivoting) 480...2

(locking) 485...2

Fixed end

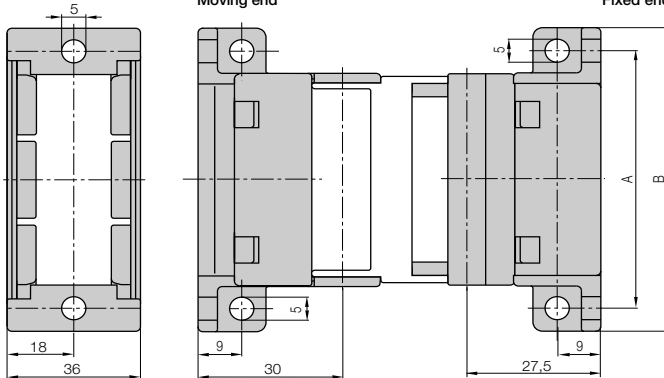

Dimensions and order configurations

Part No. structure (pivoting)

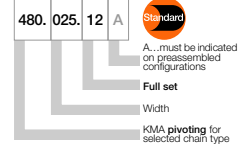

Full set, for both ends:

480.025.12

Single-part order:

480.025.1

Mounting bracket with bore

480.025.2

Mounting bracket with pin

Part No. structure (locking)

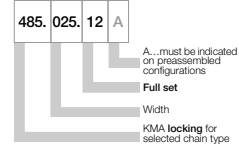

Full set, for both ends:

485.025.12

Single-part order:

485.025.1

Mounting bracket with bore

485.025.2

Mounting bracket with pin

For Series	Part No. full set	Dim. A [mm]	Dim. B [mm]
48.025 ▶	...025.12	45	55
48.050 ▶	...050.12	70	80
48.075 ▶	...075.12	95	105
48.100 ▶	...100.12	120	130
48.130 ▶	...130.12	150	160

Please add the Part No. with the requested index - 480 for the pivoting configuration

e.g. 480.025.12 or 485 for the locking configuration e.g. 485.025.12

For the preassembled mode please add the index **A** e.g. 480.025.12 **A**

The following parts are required for attachment of the mounting brackets:

- Socket head cap bolt M5 DIN 912-8.8 Length depends on the thickness of the attachment base
- Washer 5,3 DIN 125-ST ● Hexagon nut M5 DIN 934-8



Strain relief separator for the use in the first or last chain link ▶ page 6.32

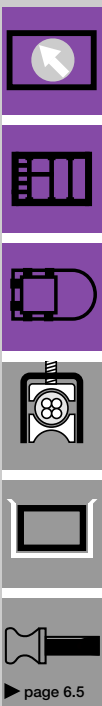



Steel mounting bracket

- Locked connection to E-Tube
- Electrically conductive
- Minimized external width

Moving end (outer link)
482...1

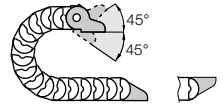

482...2

Fixed end (inner link)

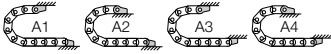

Possible installation conditions -

Further installation angles ► installation sketch

Dimensions and order configurations

482...1

Moving end

482...2

Fixed end

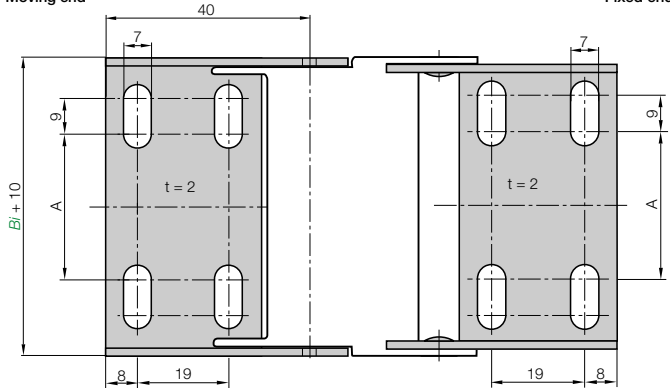

Phone +49- (0) 22 03-96 49-800
Fax +49- (0) 22 03-96 49-222

igus® GmbH
51147 Cologne

Part No. structure

482.050.12.A1

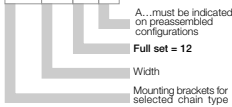

Full set, for both ends:

482.050.12

Single-part order:

482.050.1

Mounting bracket with bore

482.050.2

Mounting bracket with pin

For Series	Part No. full set	Dim. A [mm]
48.025. ►	482.025.12	-
48.050. ►	482.050.12	22
48.075. ►	482.075.12	47
48.100. ►	482.100.12	72
48.130. ►	482.130.12	102

Please add the Part No. with the requested index - e.g. 482.050.12

For the preassembled mode please add the index A1 ... A4 e.g. 482.050.12.A1

The following parts are required for attachment of the mounting brackets:

- Socket head cap bolt M5 DIN 912-8.8 Length depends on the thickness of the attachment base
- Washer 5,3 DIN 125-ST ● Hexagon nut M5 DIN 934-8

Internet: www.igus.eu
E-mail: info@igus.de



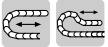

Angled polymer bracket

- Attachment option for strain relief tiewrap plate
- Locked connection to E-Tube
- Minimized external width

Moving end (outer link)
4800...1(PZB)

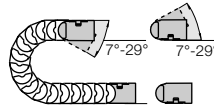

4800...2(PZB)
Fixed end (inner link)

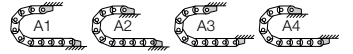

Possible installation conditions for assembled mounting brackets ▶ Order example "preassembled" below

4800...1(PZB)
Moving end

4800 ...2(PZB)
Fixed end

Dimensions and order configurations

Strain relief is possible on the moving end and/or the fixed end.

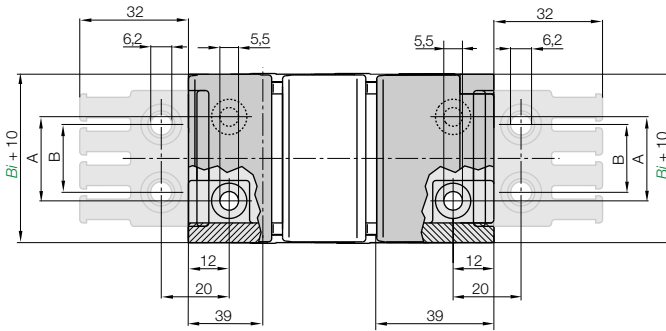

For Series	Part No. Full set with tiewrap plates	Part No. Full set without tiewrap plates	Dim. A [mm]	Dim. B [mm]
48.025. ▶	4800.025.12PZB	4800.025.12	12	15
48.050. ▶	4800.050.12PZB	4800.050.12	37	30
48.075. ▶	4800.075.12PZB	4800.075.12	62	60
48.100. ▶	4800.100.12PZB	4800.100.12	87	80
48.130. ▶	-	4800.130.12	117	-

Please add the Part No. with the requested index - e.g. 4800.050.12 PZB

For the preassembled mode please add the index A1...A4 e.g. 4800.050.12PZB A1

The following parts are required for attachment of the mounting brackets:

- Countersunk bolt M5 DIN 912-8.8 Length depends on the thickness of the attachment base
- Hexagon nut M5 DIN 934-8

Part No. structure

4800.025.12 PZB A1

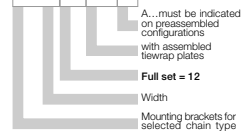

Full set, for both ends:

4800.025.12 PZB

Single-part order:

4800.025.1 PZB

Mounting bracket with bore

4800.025.2 PZB

Mounting bracket with pin

Phone +49- (0) 22 03-96 49-800
Fax +49- (0) 22 03-96 49-222



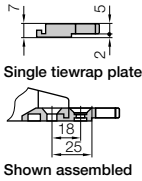

Tiewrap plate as individual part

As individual component screwed on KMA. Can be plugged in the mounting brackets. **Details** ► **chapter 10**

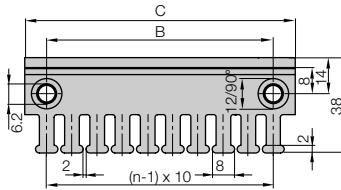

Tiewrap plate	No. of teeth <i>n</i>	Dim. C [mm]	Dim. B [mm]
2020.ZB	3	30	15
2030.ZB	4	40	20
2040.ZB	5	50	30
2050.ZB	6	60	40
2070.ZB	8	80	60
2090.ZB =			
(2030.ZB + 2040.ZB)	9	90	-
2100.ZB	10	100	80
2125.ZB =			
(2050.ZB + 2050.ZB)	12	120	-



Cable tiewraps as individual part

Cable tiewraps (100-piece bag)	Width x length	max. Ø	Tensile strength
CFB.001	4,8 x 150 mm	36 mm	222 N

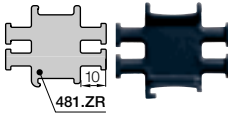

Strain relief separator

Separator with integrated strain relief, for use in the first or last chain link. For manufacturing of switchgear cabinets or for the assembly of machines. Easy to assemble without any fastening device. Separator base 481.ZR is 10 mm wide. The possible number of separators per E-Chain® is defined by its inner width *Bi* and by the cable-diameter. **Details** ► **chapter 10**

Part No.	Number of teeth	For Series
481.ZR	2 both sides	R48 E-Tube

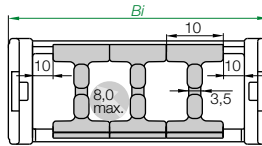

Strain Relief Separator - The number of separators is depending on the cables and the available inner space. Example: E-Chain® inner width *Bi* 50 mm: 3 Strain Relief Separator, max. cable diameter 8 mm. **Details** ► **chapter 10**



Other strain relief elements
 ► **chapter 10**

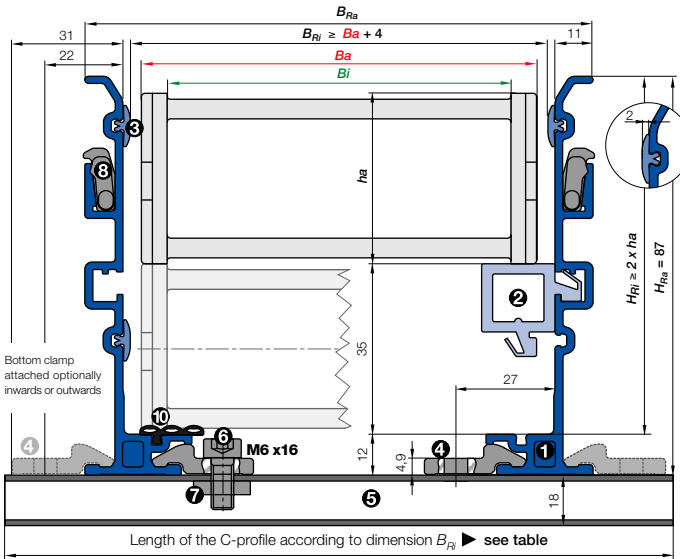

- B_a = Outer width E-Chains* / E-Tube
 - B_i = Inner width E-Chains* / E-Tube
 - h_a = Outer height E-Chains* / E-Tube
 - H_{Ri} = Inner trough height
 - H_{Ra} = Outer trough height
 - B_{Ri} = Inner trough width ► depends on dim. B_a
 - B_{Ra} = Outer trough width
 - n_{Mon} = Number of installation sets (left/right)
 - n_{Ri} = Number of troughs sets (left/right)
- $H_{Ri} \geq 2 \cdot h_a$
 $B_{Ri} \geq B_a + 4$
- = Guide trough set
 - = Installation set "Basic"
 - = C-profile
 - = Glide bar

Installation set "Basic" with C-profile

Bottom Clamp attached optionally inwards or outwards

48.100.075.0 ► Order example

B_{Ri} [mm]	Part No.	
	attached inwards	attached outwards
.025 40	-	960.30.150
.050 65	-	960.30.175
.075 90	960.30.150	960.30.200
.100 115	960.30.175	960.30.225
.130 145	960.30.200	960.30.250



- **Components, trough "Basic":** ① Trough side parts, aluminum, 2 m ② Glide bar, plastic, 2 m ③ Glide strips, plastic, 2 m (without glide strips on request) ⑩ Optional: Silencer profile, rubber
- **Components, installation set "Basic":** ④ Bottom clamp, aluminum ⑤ C-profile, steel galvanized ⑥ Screw M6 x16 ⑦ Sliding nut M6 ⑧ Interface connector, plastic



Order example: Length of travel 30 m - Center mounted for Series 48.100.075.0 with $B_{Ri} = 115$

Guide trough set (set of 2 trough side parts, incl. glide strips) **without** glide bar

Order text: 16 m guide trough without glide bar (8 x 2 m sections) Part No. 971.30.SL

Guide trough set (set of 2 trough side parts, incl. glide strips) **with** glide bar

Order text: 16 m guide trough with glide bar (8 x 2 m sections) Part No. 971.31.SL

Installation set "Basic" complete (guide trough-sets + 1)

Order text: 17 installation sets "Basic" Part No. 960.30.175

Option: For an additional noise dampening with silencer profile, please add Index A - Example:

Part No. 971.30.SLA

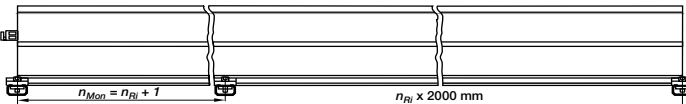

Principle sketch: Number of installation sets to be installed = **Number of trough sections + 1**

Other guide trough systems



"Heavy Duty" for the fastidious construction with glide bar and silencer profiles

► chapter 9



"Steel trough" very stable and robust guide trough out of steel, 2 pieces, adjustable on chain width

► chapter 9

Insert for the installation set

"Heavy Duty": **971.50.XXX**

instead of (960.30.XXX) on the right column "attached outwards"

Phone +49- (0) 22 03-96 49-800
 Fax +49- (0) 22 03-96 49-222



► page 6.5



Price index



UL94-V2 classifications
upon request



ESD classification:
Electrically conductive
ESD/ATEX version upon request



E-Tubes with HT-material
for hot chips up to 850°C
available upon request



To open the E-Tube Series R lift up the lid
(with a screwdriver) and remove the lid



When to use the Series R58:

- If particularly quiet operation is required
- At very high speed
- If chip protection is subject to stringent requirements



When not to use it:

- If a particularly low-cost solution is the main factor
- Series R157/158, page 6.12

- 1 Protection for cables and hoses, against hot chips
- 2 Large pins for high stability
- 3 Removable lids along outer radius
- 4 Smooth, chip-repellent exterior
- 5 Small pitch for low-noise, smooth operation
- 6 Fully enclosed
- 7 KMA mounting brackets with attachment capability on all sides
- 8 Small pitch enables very small radii
- 9 Integrated strain relief available especially for E-Tubes ► page 6.40

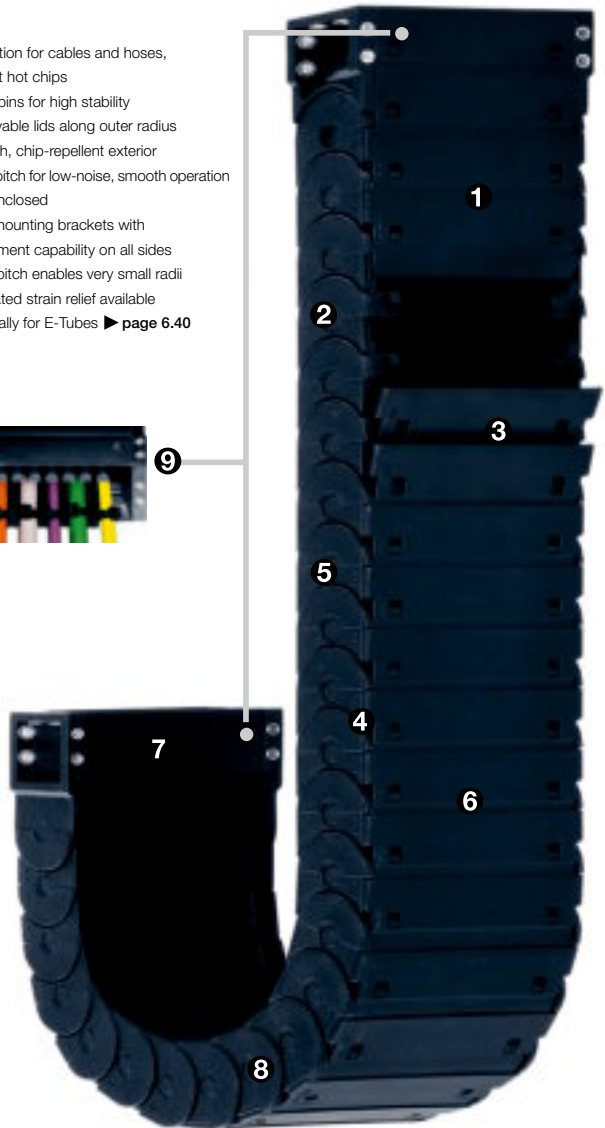

Order example complete E-Tube

Please indicate E-Tube-lengths or number of links Example: 1 m or 56 links

1 m 58.100.100.0



E-Tube

with 2 separators 582 assembled every 2nd link



Interior separation

1 set 580.100.12



Mounting bracket



Unsupported length

FL_G = with straight upper run

FL_B = with permitted sag

Further information ► Design, page 1.12

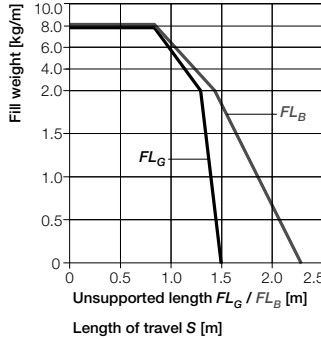
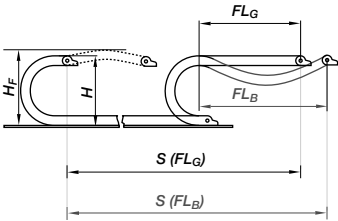

- S = Length of travel
- R = Bending radius
- H = Nominal clearance height
- H_F = Required clearance height
- H_{RI} = Trough inner height
- D = Overlength E-Chain® radius in final position
- $K = \pi \cdot R + "$ safety"
- D_2 = Overlength - long travels, gliding
- K_2 = "Further add-on"
- H_2 = "Mounting height"
- *If the mounting bracket location is set lower

Other installation methods

- Vertical, hanging ≤ 50 m
- Vertical, standing ≤ 4 m
- Side mounted, un supp. ≤ 2 m
- Rotary requires further calculation
- Unsupported length of upper run = upon request

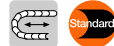

Short travels - unsupported

Unsupported E-Chains® feature positive camber over short travels. This must be accounted for when specifying the clearance height H_F . Please consult igus® if space is particularly restricted.

The required clearance height:
 $H_F = H + 35$ mm
 (with 0,5 kg/m fill weight)

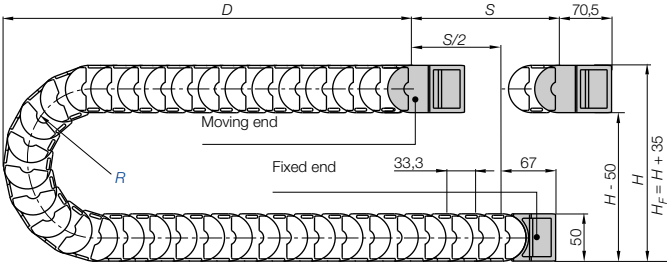

Pitch = 33,3 mm/link Links/m = 30 (999 mm) Chain length = $S/2 + K$

	075	100	125	150	200	250
R	075	100	125	150	200	250
H	200	250	300	350	450	550
D	150	175	200	225	275	325
K	375	475	550	650	825	925
H_2	200	166	166	166	166	166
D_2	150	310	380	480	800	1050
K_2	375	500	699	866	1265	1665

Long travel lengths from 10 m to max. 75 m Chain length = $S/2 + K_2$

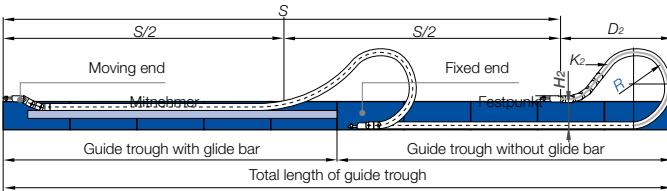

In case of travels between 4 and 10 m we recommend a longer unsupported length.



Gliding, long travel applications (max. 75 m)

In this case the E-Chain® upper run will be introduced in a guide trough on the lower run. We recommend to realize the engineering of such a plant by our technicians.

Technical Data

Speed / acceleration FL_G	max. 10 [m/s] / max. 100 [m/s²]
Speed / acceleration FL_B	max. 3 [m/s] / max. 6 [m/s²]
Gliding speed / acceleration (maximum)	max. 3 [m/s] / max. 10 [m/s²]
Material - permitted temperature °C	igumid G / -40° up to +120° C
Flammability class, igumid G	VDE 0304 IIC UL94 HB



Details of material properties
 ► page 1.38

E2 E-Tubes Type R
 Inner height: 35 mm

Phone +49- (0) 22 03-96 49-800
 Fax +49- (0) 22 03-96 49-222



► page 6.5

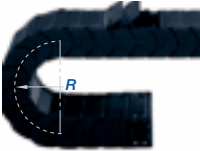
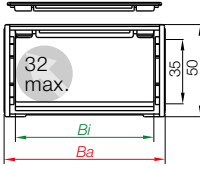

Part No. structure

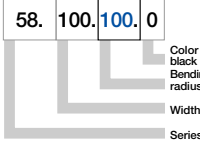

Series R58 - snap-open along outer radius

Part No.		Bi (mm)	Ba (mm)	R (mm)	Bending radii					Weight [kg/m]
58.050.	.0	50	66	075	100	125	150	200	250	≈ 1,50
58.075.	.0	75	91	075	100	125	150	200	250	≈ 1,77
58.100.	.0	100	116	075	100	125	150	200	250	≈ 2,04
58.125.	.0	125	141	075	100	125	150	200	250	≈ 2,31
58.150.	.0	150	166	075	100	125	150	200	250	≈ 2,61
58.175.	.0	175	191	075	100	125	150	200	250	≈ 2,88
58.200.	.0	200	216	075	100	125	150	200	250	≈ 3,15

Supplement Part No. with required radius. Example: 58.100. 100.0

0 = standard color, other colors ► page 1.39 · Pitch = 33,3 mm/link - Links/m = 30



Phone +49- (0) 22 03-96 49-800
Fax +49- (0) 22 03-96 49-222

igus® GmbH
51147 Cologne

Internet: www.igus.eu
E-mail: info@igus.de

Hot Chips up to 850°C

E-Tubes that repel hot chips, up to 850 °C. Some applications, depending on amount and size of the chips, can burn or melt the surface. That is no longer the case with the igus® "igumid HT" material.

Order example - Full E-Tube made of HT*: **58.100.100.0.HT**

Order example - Lids made of HT: **58.100HT.100.0**

*for long travels upon request

Delivery time up to 4 weeks! Further Information: www.igus.de/en/HT



Option 1: Vertical Separators

Vertical Separators are used if a vertical subdivision of the E-Chain® interior is required - By standard Vertical Separators are assembled every other E-Chain® link

- Standard subdivision with Vertical Separator 582

Vertical Separator	
unassembled	581
assembled	582

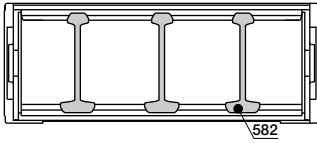

Option 2: Full-Width Shelves

For applications involving many thin cables with similar or identical diameters

- Vertical Separator, slotted 588 can be combined with Full-Width Shelf 221.X

Vert. Separator, slotted	
unassembled	587
assembled	588

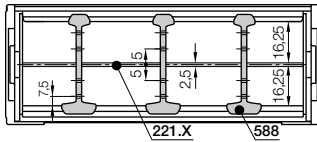

Width X [mm]	Part No. unassembled	Part No. assembled
050	220.50	221.50
075	220.75	221.75
100	220.100	221.100
125	220.125	221.125

Width X [mm]	Part No. unassembled	Part No. assembled
150	220.150	221.150
175	220.175	221.175
200	220.200	221.200

Full-Width Shelf

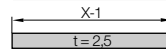

Option 3: Shelves

For applications involving many cables with similar or identical diameters. Partial separation into individual chambers can be achieved and the entire width Bi-10 mm can be used

- Shelf 2210.X can be combined with Middle Plate 586

Middle Plate	
unassembled	585
assembled	586

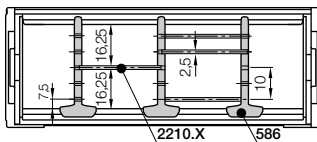

Width X [mm]	Part No. unassembled	Part No. assembled
018	2200.18	2210.18
023	2200.23	2210.23
028	2200.28	2210.28
033	2200.33	2210.33
038	2200.38	2210.38
043	2200.43	2210.43
048	2200.48	2210.48

Width X [mm]	Part No. unassembled	Part No. assembled
058	2200.58	2210.58
068	2200.68	2210.68
073	2200.73	2210.73
088	2200.88	2210.88
099	2200.99	2210.99
124	2200.124	2210.124
149	2200.149	2210.149

Shelf

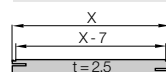

E2 E-Tubes Type R
Inner height: 35 mm

Phone +49- (0) 22 03-96 49-800
Fax +49- (0) 22 03-96 49-222



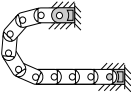

The attachment variants arising automatically by the choice of the KMA mounting bracket

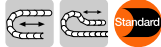

Option KMA* - pivoting

- Option - KMA with Quickflange for short and long travels
- Recommended for unsupported and gliding applications
- Space-restricted
- Universal mountable with attachment capability on all sides

*KMA = Polymer Metal Mounting Bracket

Moving end (outer link)
580...1

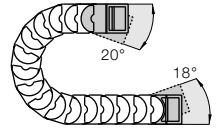

580...2

Fixed end (inner link)

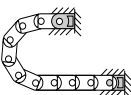

The attachment variants arising automatically by the choice of the KMA mounting bracket

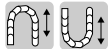

Option KMA - locking

- Option - KMA with Quickflange
- Recommended for vertical hanging / standing applications
- At very high speed and acceleration
- Universal mountable with attachment capability on all sides
- Flush mounting at both ends of the E-Tube

Moving end (outer link)
580...3

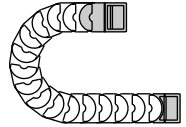

580...4

Fixed end (inner link)

Dimensions and order configurations



Quickflange upon request

Part No. structure (pivoting)

580.050.12.A



- A... must be indicated on preassembled configurations
- Full set pivoting = 12
- Width
- KMA for selected chain type

Full set, for both ends:

580.050.12

Single-part order:

580.050.1

Mounting bracket with bore

580.050.2

Mounting bracket with pin

Part No. structure (locking)

580.050.34.A

- A... must be indicated on preassembled configurations
- Full set locking = 34
- Width
- KMA for selected chain type

Full set, for both ends:

580.050.34

Single-part order:

580.050.3

Mounting bracket with bore

580.050.4

Mounting bracket with pin

Quickflange

Part No. 16800.QF, unassembled

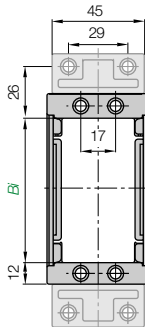

580...2 Standard! (pivoting)

Part No. 580...4 (locking)

Fixed end

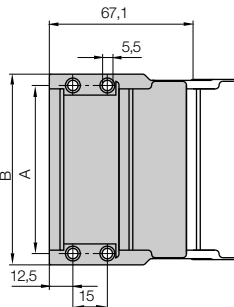

Standard! (pivoting) 580...1

(locking) 580...3

Moving end

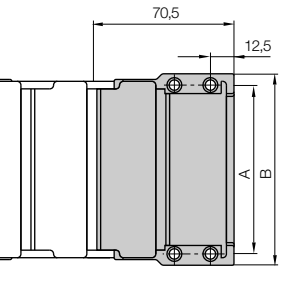

For Series	Part No. Full set	Part No. Full set with Quickflange	Dim. A [mm]	Dim. B [mm]
58.050. ▶	580.050. []	580.050. [] QF	62	74
58.075. ▶	580.075. []	580.075. [] QF	87	99
58.100. ▶	580.100. []	580.100. [] QF	112	124
58.125. ▶	580.125. []	580.125. [] QF	137	149
58.150. ▶	580.150. []	580.150. [] QF	162	174
58.175. ▶	580.175. []	580.175. [] QF	187	199
58.200. ▶	580.200. []	580.200. [] QF	212	224

Please add the Part No. with the requested index - 12 for the pivoting configuration e.g. 580.100.12 or 34 for the locking configuration e.g. 580.100.34

For the preassembled mode please add the index [A] e.g. 580.100.34 [A]

Quickflange unassembled: Part No. 16800.QF

The following parts are required for attachment of the mounting brackets:

- Socket head cap bolt M5 DIN 912-8.8 Length depends on the thickness of the attachment base
- Washer 5,3 DIN 125-ST ● Hexagon nut M5 DIN 934-8



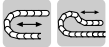

Flange mounting brackets made of steel

- Metallic flange brackets with popular hole patterns, easily be replaced by their modern successors, without having to alter the hole pattern
- Bolted connection outside of chain cross-section possible
- Universal mountable with attachment capability on all sides
- Steel, galvanized
- One-piece mounting bracket
- High stability

Moving end (outer link)
906.463.X.1

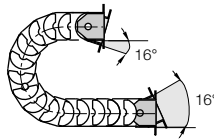

906.463.X.2

Fixed end (inner link)



Flush mounting possibilities at both ends of the E-Tube

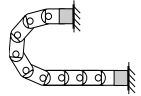

906.463.X.1
Moving end

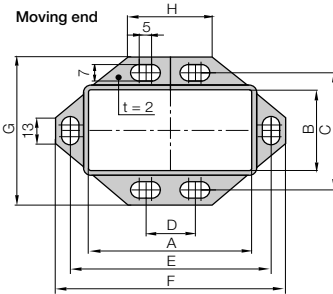

Hole pattern metallic flange
Moving end 906.463.X.1

906.463.X.2
Fixed end

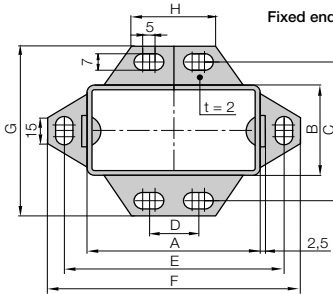

Hole pattern metallic flange
Fixed end 906.463.X.2

Dimensions and order configurations

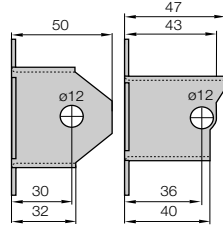

Moving end
906.463.X.1

Fixed end
906.463.X.2

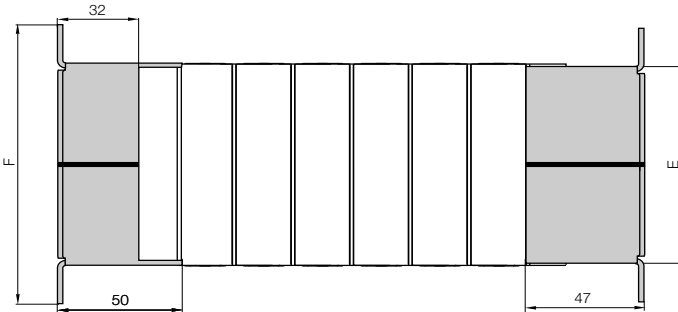

Full set, for both ends:

906.463.X.12

Single-part order:

906.463.X.1

Mounting bracket with bore

906.463.X.2

Mounting bracket with pin

For Series	Hole pattern	Part No. Moving end	Part No. Fixed end	Bi [mm]	Ba [mm]	Dim. A [mm]	Dim. B [mm]	Dim. C [mm]	Dim. D [mm]	Dim. E [mm]	Dim. F [mm]	Dim. G [mm]	Dim. H [mm]
58.050	58.05	906.463.05.1	906.463.05.2	50	66	58,3	48	68	20	78,5	90,5	82	24,5
58.075	58.1	906.463.1.1	906.463.1.2	75	91	83,3	48	68	30	104	116	82	50

Phone +49- (0) 22 03-96 49-800
Fax +49- (0) 22 03-96 49-222





Integrated strain relief for E2 E-Tubes - Series R

Characteristic features: ● Strain relief disappears completely in the E-Tube ● Easy to assemble without any screws ● **Use:** Individual part for the manufacturing of switchgear cabinets or for the assembly of machines ● Accessory for igus® E-ChainSystems®

Part. No.	Width [mm]	Number of teeth	For Series
5850.Z	46	4	R58

Number of tiewrap plates 5850.Z for selected inner width B_i

B_i [mm]	Width tiewrap plate [mm]	Number of tiewrap plate n	Total number of teeth
50	–	–	–
75	46	1	4
100	46	1	4
125	46	2	8
150	46	2	8
175	46	3	12
200	46	3	12

Phone +49- (0) 22 03-96 49-800
Fax +49- (0) 22 03-96 49-222

igus® GmbH
51147 Cologne

Internet: www.igus.eu
E-mail: info@igus.de



Other strain relief elements

► chapter 10

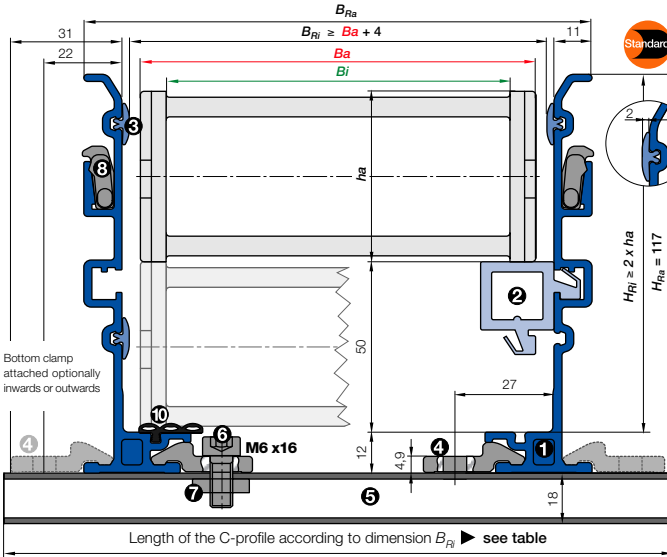

- B_a = Outer width E-Chains* / E-Tube
- B_i = Inner width E-Chains* / E-Tube
- h_a = Outer height E-Chains* / E-Tube
- H_{Ri} = Inner trough height
- H_{Ra} = Outer trough height
- B_{Ri} = Inner trough width ► depends on dim. B_a
- B_{Ra} = Outer trough width
- n_{Mon} = Number of installation sets (left/right)
- n_{Ri} = Number of troughs sets (left/right)
- ! $H_{Ri} \geq 2 \cdot h_a$
- ! $B_{Ri} \geq B_a + 4$
- = Guide trough set ● = Glide bar
- = Installation set "Basic" ● = C-profile

Installation set "Basic" with C-profile

Bottom Clamp attached optionally inwards or outwards

58.075.200.0 ► Order example

B_{Ri} [mm]	Part No.	
	attached inwards	attached outwards
.050	70	960.30.175
.075	95	960.30.150
.100	120	960.30.175
.125	145	960.30.200
.150	170	960.30.225
.175	195	960.30.250
.200	220	960.30.275
		960.30.325



- **Components, trough "Basic":** ① Trough side parts, aluminum, 2 m ② Glide bar, plastic, 2 m ③ Glide strips, plastic, 2 m (without glide strips on request) ⑩ Optional: Silencer profile, rubber
- **Components, installation set "Basic":** ④ Bottom clamp, aluminum ⑤ C-profile, steel galvanized ⑥ Screw M6 x16 ⑦ Sliding nut M6 ⑧ Interface connector, plastic

Order example: Length of travel 30 m - Center mounted for Series 58.075.200.0 with $B_{Ri} = 95$

- Guide trough set (set of 2 trough side parts, incl. glide strips) **without** glide bar
- Order text: 16 m guide trough without glide bar (8 x 2 m sections) **Part No. 972.30.SL**
- Guide trough set (set of 2 trough side parts, incl. glide strips) **with** glide bar
- Order text: 16 m guide trough with glide bar (8 x 2 m sections) **Part No. 972.32.SL**
- Installation set "Basic" complete (guide trough-sets + 1)
- Order text: 17 installation sets "Basic" **Part No. 960.30.150**
- Option: For an additional noise dampening with silencer profile, please add Index A - Example: **Part No. 972.30.SLA**

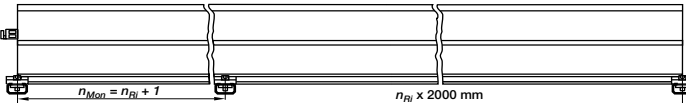

Principle sketch: Number of installation sets to be installed = **Number of trough sections + 1**

Other guide trough systems



"Heavy Duty" for the fastidiously construction with glide bar and silencer profiles
 ► chapter 9



"Steel trough" very stable and robust guide trough out of steel, 2 pieces, adjustable on chain width
 ► chapter 9



Price index

UL94-V2 classifications upon request

ESD classification: Electrically conductive ESD/ATEX version upon request

iF-Design Award Winner Series R68

E-Tubes with HT-material for hot chips up to 850°C available upon request



To open the E-Tube Series R lift up the lid (with a screwdriver) and remove the lid



When to use the Series R68:

- If particularly quiet operation is required
- At very high speed
- If chip protection is subject to stringent requirements



When not to use it:

- If a particularly low-cost solution is the main factor
 - ▶ Series R117/R118, page 6.6
- If no chip protection is required
 - ▶ Series 2400/2500 E2/000, page 5.102

- 1 Protection for cables and hoses, against hot chips
- 2 Large pins for high stability
- 3 Smooth, chip-repellent exterior
- 4 Small pitch for low-noise, smooth operation
- 5 Removable lids along outer radius
- 6 Fully enclosed
- 7 KMA mounting brackets with attachment capability on all sides
- 8 Integrated strain relief available especially for E-Tubes ▶ page 6.48



Order example complete E-Tube

Please indicate E-Tube-lengths or number of links **Example: 1 m or 28 links**

1 m **68.100.100.0**



E-Tube

with 2 separators **311** assembled every 2nd link



Interior separation

1 set **680.100.12**



Mounting bracket

Unsupported length

FL_G = with straight upper run

FL_B = with permitted sag

Further information ► Design, page 1.12

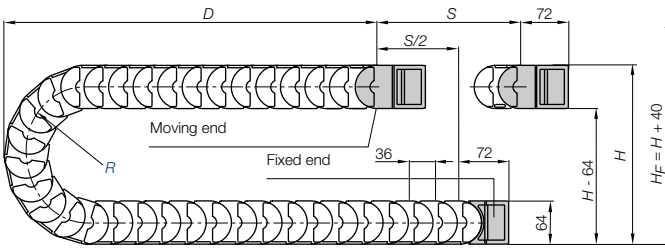
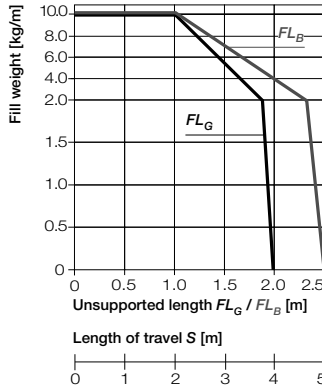
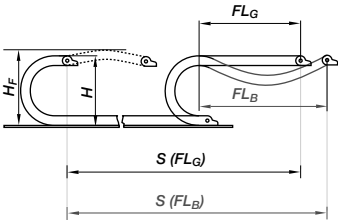

Pitch = 36 mm/link Links/m = 28 (1008 mm) Chain length = $S/2 + K$

	100	125	150	175	200	225	250	300
R	100	125	150	175	200	225	250	300
H	265	315	365	415	465	515	565	665
D	200	225	250	275	300	325	350	400
K	500	650	725	800	875	975	1050	1225
H_2	265	220	220	220	220	220	220	220
D_2	200	370	440	540	650	700	850	1050
K_2	500	648	792	900	1116	1269	1476	1800

- S = Length of travel
- R = Bending radius
- H = Nominal clearance height
- H_F = Required clearance height
- H_{RI} = Trough inner height
- D = Overlength E-Chain® radius in final position
- $K = \pi \cdot R + "$ safety"
- D_2 = Overlength - long travels, gliding
- K_2 = "Further add-on
- H_2 = "Mounting height
- *if the mounting bracket location is set lower

Other installation methods

- Vertical, hanging ≤ 60 m
- Vertical, standing ≤ 4 m
- Side mounted, un supp. ≤ 2 m
- Rotary requires further calculation
- Unsupported length of upper run = upon request

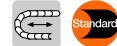

Short travels - unsupported

Unsupported E-Chains® feature positive camber over short travels. This must be accounted for when specifying the clearance height H_F . Please consult igus® if space is particularly restricted.

The required clearance height:
 $H_F = H + 40$ mm
 (with 2.5 kg/m fill weight)

Long travel lengths from 10 m to max. 100 m Chain length = $S/2 + K_2$

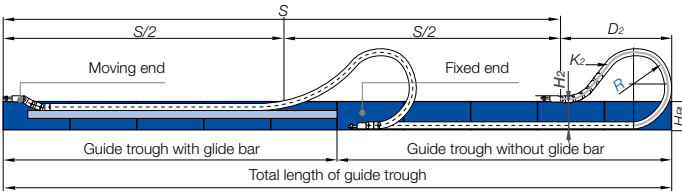

In case of travels between 4 and 10 m we recommend a longer unsupported length.



Gliding, long travel applications (max. 100 m)

In this case the E-Chain® upper run will be introduced in a guide trough on the lower run. We recommend to realize the engineering of such a plant by our technicians.

Technical Data

Speed / acceleration FL_G	max. 10 [m/s] / max. 100 [m/s ²]
Speed / acceleration FL_B	max. 3 [m/s] / max. 6 [m/s ²]
Gliding speed / acceleration (maximum)	max. 3 [m/s] / max. 10 [m/s ²]
Material - permitted temperature °C	igumid G / -40° up to +120° C
Flammability class, igumid G	VDE 0304 IIC UL94 HB



Details of material properties
 ► page 1.38



E2 E-Tubes Type R
 Inner height: 45 mm

Phone +49- (0) 22 03-96 49-800
 Fax +49- (0) 22 03-96 49-222



► page 6.5

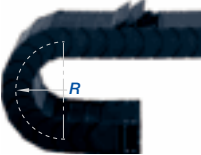
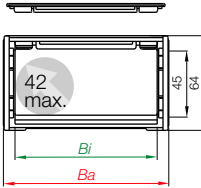

Part No. structure

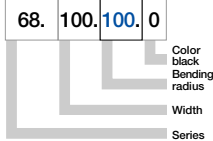

Series R68 - snap-open along outer radius

Part No.		Bi (mm)	Ba (mm)	R (mm)	Bending radii								Weight [kg/m]
68.050.	.0	50	68	100	125	150	175	200	225	250	300	≈ 1,90	
68.075.	.0	75	93	100	125	150	175	200	225	250	300	≈ 2,18	
68.100.	.0	100	118	100	125	150	175	200	225	250	300	≈ 2,46	
68.115.	.0	115	133	100	125	150	175	200	225	250	300	≈ 2,63	
68.125.	.0	125	143	100	125	150	175	200	225	250	300	≈ 2,77	
68.150.	.0	150	168	100	125	150	175	200	225	250	300	≈ 3,05	
68.175.	.0	175	193	100	125	150	175	200	225	250	300	≈ 3,36	
68.200.	.0	200	218	100	125	150	175	200	225	250	300	≈ 3,64	
68.225.	.0	225	243	100	125	150	175	200	225	250	300	≈ 3,92	
68.250.	.0	250	268	100	125	150	175	200	225	250	300	≈ 4,23	

Supplement Part No. with required radius. Example: 68.100.100.0

0 = standard color, other colors ► page 1.39 · Pitch = 36 mm/link · Links/m = 28



Hot Chips up to 850°C

E-Tubes that repel hot chips, up to 850 °C. Some applications, depending on amount and size of the chips, can burn or melt the surface. That is no longer the case with the igus® "igumid HT" material.

Order example - Full E-Tube made of HT*: **68.100.100.0.HT**

Order example - Lids made of HT: **68.100HT.100.0**

*for long travels upon request

Delivery time up to 4 weeks! Further Information: www.igus.de/en/HT



Option 1: Vertical Separators

Vertical Separators are used if a vertical subdivision of the E-Chain® interior is required - By standard Vertical Separators are assembled every other E-Chain® link

- Standard subdivision with Vertical Separator 311 (if you select bending radius R = 100 please use Vertical Separator 34511)

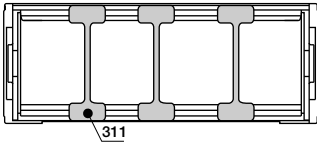

Vertical Separator*

unassembled	301
assembled	311

*not suitable for bending radius = 100



Vertical Separator, for bending radius R = 100

unassembled	34501
assembled	34511



Option 2: Full-Width Shelves

For applications involving many thin cables with similar or identical diameters

- Vertical Separator, slotted 312 or Vertical Separator, slotted 312.24 with wide base can be combined with Full-Width Shelf 221.X

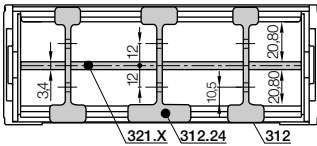

Vert. Separator, slotted

unassembled	302
assembled	312



Vert. Separator, slotted

unassembled	302.24
assembled	312.24



Width X [mm]	Part No. unassembled	Part No. assembled
50	320.050	321.050
75	320.075	321.075
100	320.100	321.100
115	320.115	321.115
125	320.125	321.125

Width X [mm]	Part No. unassembled	Part No. assembled
150	320.150	321.150
175	320.175	321.175
200	320.200	321.200
225	320.225	321.225
250	320.250	321.250

Full-Width Shelf

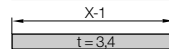

Option 3: Shelves

For applications involving many cables with similar or identical diameters. Partial separation into individual chambers can be achieved and the entire width Bi-10 mm can be used

- Shelf 2210.X can be combined with Side Plate 313 and Middle Plate 314
- Option 3 "Shelves" can also be combined with option 1 "Vertical Separators"

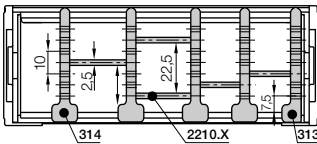

Side Plate

unassembled	303
assembled	313



Middle Plate

unassembled	304
assembled	314



Width X [mm]	Part No. unassembled	Part No. assembled
018	2200.18	2210.18
023	2200.23	2210.23
028	2200.28	2210.28
033	2200.33	2210.33
038	2200.38	2210.38
043	2200.43	2210.43
048	2200.48	2210.48

Width X [mm]	Part No. unassembled	Part No. assembled
058	2200.58	2210.58
068	2200.68	2210.68
073	2200.73	2210.73
088	2200.88	2210.88
099	2200.99	2210.99
124	2200.124	2210.124
149	2200.149	2210.149

Shelf

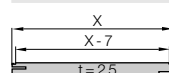

E2 E-Tubes Type R
Inner height: 45 mm

Phone +49- (0) 22 03-96 49-800
Fax +49- (0) 22 03-96 49-222



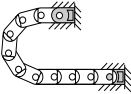

The attachment variants arising automatically by the choice of the KMA mounting bracket

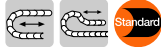

Option KMA* - pivoting

- Recommended for unsupported and gliding applications
- Option - KMA with Quickflange
- Short and long travels
- Universal mountable with attachment capability on all sides

*KMA = Polymer Metal Mounting Bracket

Moving end (outer link)
680...1

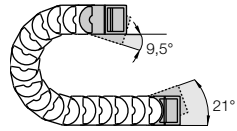

680...2

Fixed end (inner link)

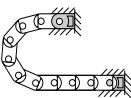

The attachment variants arising automatically by the choice of the KMA mounting bracket

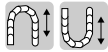

Option KMA - locking

- Recommended for vertical hanging / standing applications
- Option - KMA with Quickflange
- At very high speed and acceleration
- Universal mountable with attachment capability on all sides
- Flush mounting at both ends of the E-Tube

Moving end (outer link)
680...3

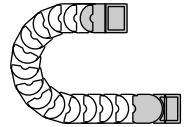

680...4

Fixed end (inner link)

Dimensions and order configurations



Quickflange upon request

Part No. structure (pivoting)

680.100.12.A



A... must be indicated on preassembled configurations
Full set pivoting = 12
Width
KMA for selected chain type

Full set, for both ends:

680.100.12

Single-part order:

680.100.1

Mounting bracket with bore

680.100.2

Mounting bracket with pin

Part No. structure (locking)

680.100.34.A



A... must be indicated on preassembled configurations
Full set locking = 34
Width
KMA for selected chain type

Full set, for both ends:

680.100.34

Single-part order:

680.100.3

Mounting bracket with bore

680.100.4

Mounting bracket with pin

Quickflange
Part No. 16800.QF,
unassembled

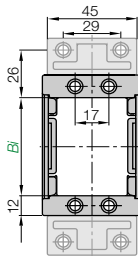

680...1 Standard! (pivoting)
680...3 (locking)
Moving end

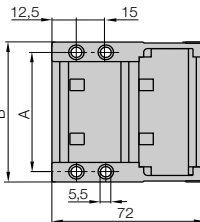

Standard! (pivoting) 680...2
(locking) 680...4
Fixed end

For Series	Part No. Full set	Part No. Full set with Quickflange	Dim. A [mm]	Dim. B [mm]
68.050. ▶	680.050. []	680.050. [] QF	62	74
68.075. ▶	680.075. []	680.075. [] QF	87	99
68.100. ▶	680.100. []	680.100. [] QF	112	124
68.115. ▶	680.115. []	680.115. [] QF	127	139
68.125. ▶	680.125. []	680.125. [] QF	137	149
68.150. ▶	680.150. []	680.150. [] QF	162	174
68.175. ▶	680.175. []	680.175. [] QF	187	199
68.200. ▶	680.200. []	680.200. [] QF	212	224
68.225. ▶	680.225. []	680.225. [] QF	237	249
68.250. ▶	680.250. []	680.250. [] QF	262	274

Please add the Part No. with the requested index - 12 for the pivoting configuration e.g. 680.100.12 or 34 for the locking configuration e.g. 680.100.34

For the preassembled mode please add the index [A] e.g. 680.100.34 [A]

Quickflange unassembled: Part No. 16800.QF

The following parts are required for attachment of the mounting brackets:

- Socket head cap bolt M5 DIN 912-8.8 Length depends on the thickness of the attachment base
- Washer 5,3 DIN 125-ST ● Hexagon nut M5 DIN 934-8



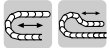

Flange mounting brackets made of steel

- Metallic flange brackets with popular hole patterns, easily be replaced by their modern successors, without having to alter the hole pattern
- Bolted connection outside of chain cross-section possible
- Universal mountable with attachment capability on all sides
- Steel, galvanized
- One-piece mounting bracket
- High stability

Moving end (outer link)
906.462.X.1

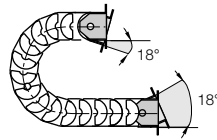

906.462.X.2

Fixed end (inner link)

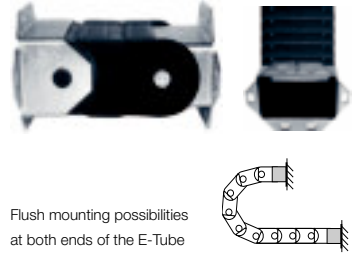

Flush mounting possibilities at both ends of the E-Tube

906.462.X.1
Moving end

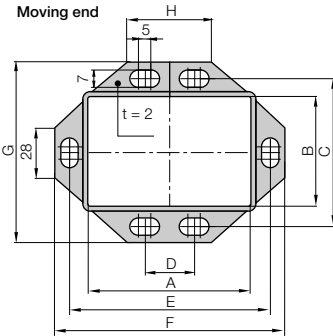

Hole pattern metallic flange
Moving end 906.462.X.1

906.462.X.2
Fixed end

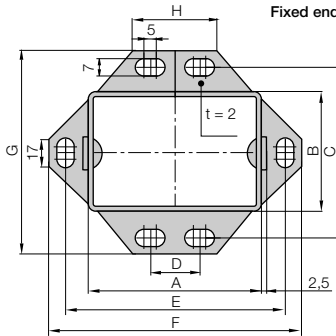

Hole pattern metallic flange
Fixed end 906.462.X.2

Dimensions and order configurations

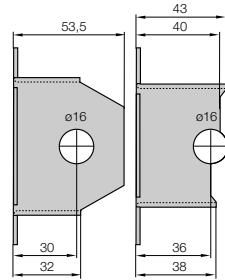

Moving end
906.462.X.1

Fixed end
906.462.X.2

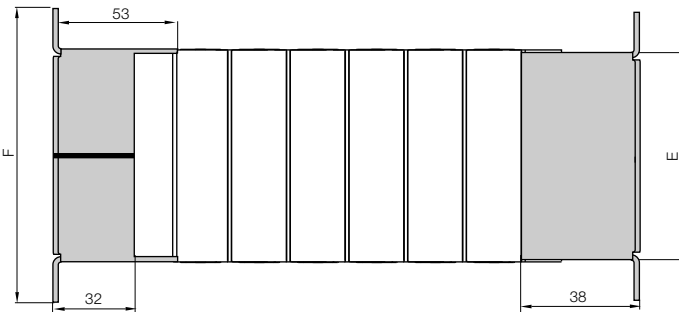

Full set, for both ends:

906.462.X.12

Single-part order:

906.462.X.1

Mounting bracket with bore

906.462.X.2

Mounting bracket with pin

For Series	Hole pattern	Part No. Moving end	Part No. Fixed end	Bi [mm]	Ba [mm]	Dim. A [mm]	Dim. B [mm]	Dim. C [mm]	Dim. D [mm]	Dim. E [mm]	Dim. F [mm]	Dim. G [mm]	Dim. H [mm]
68.075	▶ 68.1	906.462.1.1	906.462.1.2	75	93	83,4	59	80	30	104	116	95	38
68.115	▶ 68.2	906.462.2.1	906.462.2.2	115	133	123,4	59	80	50	144	156	95	78
68.175	▶ 68.3	906.462.3.1	906.462.3.2	175	193	183,4	59	80	100	204	216	95	138

Phone +49- (0) 22 03-96 49-800
Fax +49- (0) 22 03-96 49-222





Integrated strain relief for E2 E-Tubes - Series R

Characteristic features: ● Strain relief disappears completely in the E-Tube ● Easy to assemble without any screws ● **Use:** Individual part for the manufacturing of switchgear cabinets or for the assembly of machines ● Accessory for igus® E-ChainSystems®

Part. No.	Width [mm]	Number of teeth	For Series
3050.Z	50	5	R68
3075.Z	75	7	R68

Number of tiewrap plates 3050.Z for selected inner width B_i

B_i [mm]	Width tiewrap plate [mm]	Number of tiewrap plate n	Total number of teeth
50	-	-	-
75	-	-	-
100	50	1	5
115	50	1	5
125	50	1	5
150	50	2	10
175	50	2	10
200	50	3	15
225	50	3	15
250	50	4	20

Number of tiewrap plates 3075.Z for selected inner width B_i

B_i [mm]	Width tiewrap plate [mm]	Number of tiewrap plate n	Total number of teeth
50	-	-	-
75	-	-	-
100	-	-	-
115	75	1	7
125	75	1	7
150	75	1	7
175	75	2	14
200	75	2	14
225	75	3	21
250	75	3	21



Other strain relief elements

► chapter 10

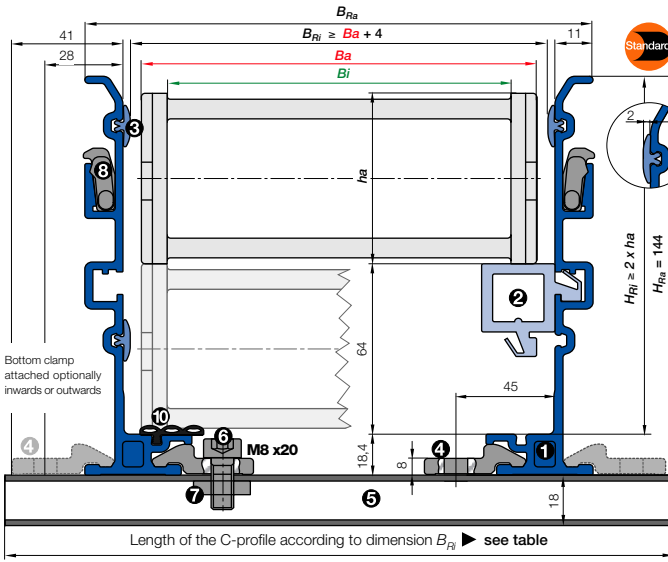

- B_a = Outer width E-Chains* / E-Tube
 - B_i = Inner width E-Chains* / E-Tube
 - h_a = Outer height E-Chains* / E-Tube
 - H_{Ri} = Inner trough height
 - H_{Ra} = Outer trough height
 - B_{Ri} = Inner trough width ► depends on dim. B_a
 - B_{Ra} = Outer trough width
 - n_{Mon} = Number of installation sets (left/right)
 - n_{Ri} = Number of troughs sets (left/right)
- $H_{Ri} \geq 2 \cdot h_a$
 $B_{Ri} \geq B_a + 4$
- = Guide trough set
 - = Glide bar
 - = Installation set "Basic"
 - = C-profile

Installation set "Basic" with C-profile

Bottom Clamp attached optionally inwards or outwards

68.100.200.0 ► Order example

B_{Ri} [mm]	Part No.	
	attached inwards	attached outwards
.050	72	960.40.200
.075	97	960.40.225
.100	122	960.40.175
.115	137	960.40.200
.125	147	960.40.200
.150	172	960.40.225
.175	197	960.40.250
.200	222	960.40.275
.225	247	960.40.300
.250	272	960.40.325



- **Components, trough "Basic":** ① Trough side parts, aluminum, 2 m ② Glide bar, plastic, 2 m ③ Glide strips, plastic, 2 m (without glide strips on request) ⑩ Optional: Silencer profile, rubber
- **Components, installation set "Basic":** ④ Bottom clamp, aluminum ⑤ C-profile, steel galvanized ⑥ Screw M6 x16 ⑦ Sliding nut M6 ⑧ Interface connector, plastic

Order example: Length of travel 30 m - Center mounted for Series 68.100.200.0 with $B_{Ri} = 122$

- Guide trough set (set of 2 trough side parts, incl. glide strips) **without** glide bar
- Order text: 16 m guide trough without glide bar (8 x 2 m sections) Part No. 973.30.SL**
- Guide trough set (set of 2 trough side parts, incl. glide strips) **with** glide bar
- Order text: 16 m guide trough with glide bar (8 x 2 m sections) Part No. 973.31.SL**
- Installation set "Basic" complete (guide trough-sets + 1)
- Order text: 17 installation sets "Basic" Part No. 960.40.175**
- Option:** For an additional noise dampening with silencer profile, please add Index A - Example: **Part No. 973.30.SLA**

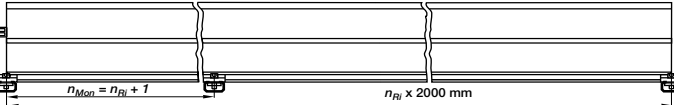

Principle sketch: Number of installation sets to be installed = **Number of trough sections + 1**

Other guide trough systems



"Heavy Duty" for the fastidiously construction with glide bar and silencer profiles
 ► chapter 9



"Steel trough" very stable and robust guide trough out of steel, 2 pieces, adjustable on chain width
 ► chapter 9

Insert for the installation set "Heavy Duty": **973.50.XXX** instead of (960.40.XXX) on the right column "attached outwards"

Phone +49- (0) 22 03-96 49-800
 Fax +49- (0) 22 03-96 49-222



A black RX E-Tube is shown being cut by a chainsaw. The tube is positioned horizontally across the middle of the frame. The chainsaw's blade is visible at the top right, cutting through the tube. A large amount of wood chips is flying off from the cut, creating a dynamic scene. The background is a solid purple color. The text "RX E-Tubes" is written in large, white, sans-serif font across the middle of the image.

RX E-Tubes



RX40* - Totally new E-Tube with chip repellent design

A world premiere from igus® - a totally redesigned E-Tube repels chips, is extremely tight, and still openable!

- Full chip protection without undercuts, projecting edges and gaps
- Round contour prevents chip accumulation
- Large interior cross section with 52 mm max. inner height
- Covered pin/bore connection and stop dogs
- Reverse bending radius (RBR) becomes a standard option

Typical industries and applications

- Tooling machines
- Woodworking machines
- All kind of industries and machines with chip, dirt and dust

*New product - Design alterations possible 08/2009



ESD Classification: Electrically conductive
ESD/ATEX version upon request



UL94-V2 classifications
upon request



E-Tubes with HT-material for hot chips
up to 850°C available upon request





RX E-Tubes, without undercuts, projecting edges and gaps

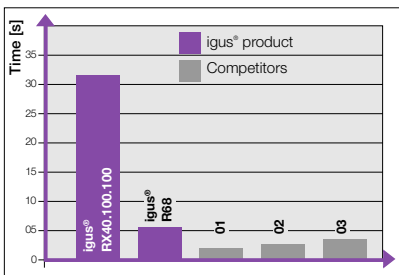

Test 1: Drowning - Various tube styles were drowned under water. For the RX E-Tube, it takes more than 30 sec. to fill up with water

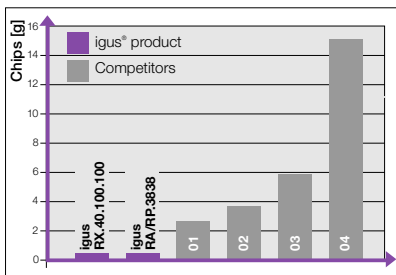

Test 2: Chip intrusion - Various tube styles were charged with a defined quantity of chips. Only 0,2 g of chips were found inside the new RX E-Tube after 80.000 cycles



Chip-test at the igus® test-lab proven enormous tightness. Video online ► www.igus.eu/en/RX_tested

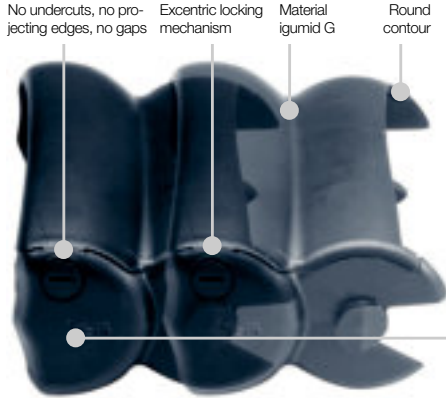

Serie RX - new chip protected design, small pitch, lids to open

- Full chip protection without undercuts, projecting edges and gaps
- Round contour prevents chip accumulation
- Large interior cross section with 52 mm max. inner height
- Covered pin/bore connection and stop dogs
- Reverse bending radius (RBR) becomes a standard option
- Perfect fastening with flange mounting brackets
- You can find more technical data about the material, chemical resistance, temperatures ► [chapter Design, page 1.38](#)

Selection table

Series	Inner height <i>hi</i> [mm]	Inner width <i>Bi</i> [mm]	Outer width <i>Ba</i> [mm]	Outer height <i>ha</i> [mm]	Bending radius <i>R</i> [mm]	Unsupported length max. [m]	Page
RX40	31/52	100	123	70	100	1,5	6.56



Chips-protected for all kinds of chips

Opening | RX40



Easy opening of lids on the outer radius with embedded excentric locking mechanism

Interior separation | RX40



Interior separation with cable-friendly separators and shelves available





Price index



UL94-V2 classifications
upon request



ESD classification:
Electrically conductive
ESD/ATEX version upon request



E-Tubes with HT-material for
hot chips up to 850°C available
upon request

- ① Full chip protection without undercuts, projecting edges and gaps
- ② Round contour prevents chip accumulation
- ③ Large interior cross section with 2 mm max. inner height
- ④ Grooved pin/bore connection and stop dogs
- ⑤ Reverse bending radius (RB) becomes a standard option
- ⑥ Lid to open from outer radius
- ⑦ Mounting bracket (optional: with strain relief) available
- ⑧ Interior separation available
- ⑨ Side trough available



Easy opening of lids on the outer radius with embedded excentric locking mechanism



When to use the Series RX40:

- If a fully protected E-Tube is desired
- If easy access from the outside is required



When not to use it:

- If a particularly low-cost solution is the main factor
 - ▶ Series R68, page 6.42
- If no chip protection is required
 - ▶ E2/000 Series 3400/3500, page 5.126



Order example complete E-Tube

Please indicate E-Tube-lengths or number of links **Example: 1 m or 25 links**

1 m RX40.100.100.0

Energierohr

with Separators RX40.11/RX40.12 assemb. every 2 mm link

Interior separation

1 set RX401.100.12

Mounting bracket

Unsupported length

FL_G = with straight upper run

FL_B = with permitted sag

Further information ► **Design, page 1.12**

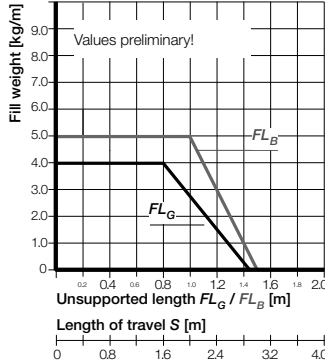
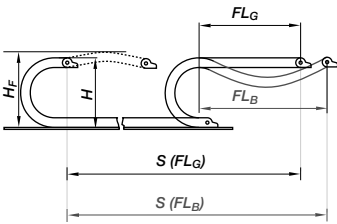

- S = Length of travel
- R = Bending radius
- H = Nominal clearance height
- H_F = Required clearance height
- D = Overlength E-Chain[®] radius in final position
- $K = \pi \cdot R + \text{"safety"}$

52

RX E-Tubes Type R
Inner height: 52 mm

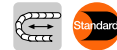
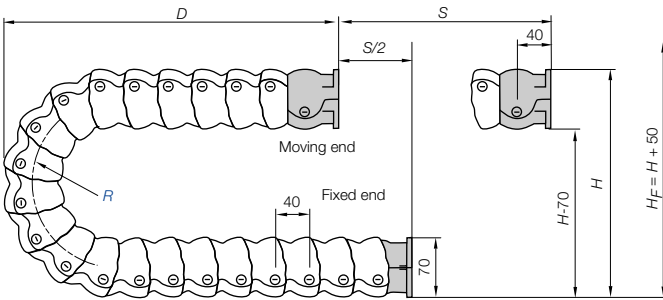

Short travels - unsupported

Unsupported E-Chains[®] feature positive camber over short travels. This must be accounted for when specifying the clearance height H_F . Please consult igus[®] if space is particularly restricted.

Pitch = 40 mm/link Links/m = 25 (1000 mm) Chain length = $S/2 + K$

R	100	125	150	175	200	225	250	275	300
H	270	320	370	420	470	520	570	620	670
D	175	200	225	250	275	300	325	350	375
K	395	475	555	630	710	790	870	945	1025

Radius 100 available - more radii upon request!

The required clearance height:
 $H_F = H + 50$ mm

Phone +49- (0) 22 03-96 49-800
Fax +49- (0) 22 03-96 49-222



Hot Chips up to 850°C

E-Tubes that repel hot chips, up to 850 °C. Some applications, depending on amount and size of the chips, can burn or melt the surface. That is no longer the case with the igus[®] "igumid HT" material.

Order example - Full E-Tube made of HT*: **RX40.100.100.0.HT**

Order example - Lids made of HT: **RX40.100.HT.100.0**

*for long travels upon request

Delivery time up to 4 weeks! Further Information: www.igus.de/en/HT



Technical Data



Details of material properties
► page 1.38

Material - permitted temperature °C	igumid G / -40° up to +120° C
Flammability class, igumid G	VDE 0304 IIC UL94 HB

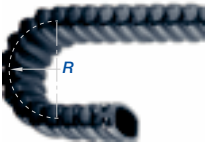
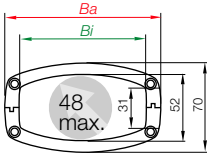

Series RX40 - snap-open along outer radius

Part No.	Bi [mm]	Ba [mm]	R [mm]	Bending radii	Weight [kg/m]
RX40.100.	<input type="text" value="0"/>	100	123	<input type="text" value="100"/> <input type="text" value="125"/> <input type="text" value="150"/> <input type="text" value="175"/> <input type="text" value="200"/> <input type="text" value="225"/> <input type="text" value="250"/> <input type="text" value="275"/> <input type="text" value="300"/>	≈ 1,89

The bending radii are available upon request!

More widths upon request!

Supplement Part No. with required radius. Example: RX40.100..0

0 = standard color, other colors ▶ page 1.39 · Pitch = 40 mm/link · links/m = 25



Part No. structure

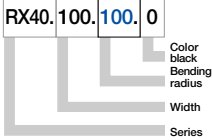

Separator, outside		
unassembled	RX40.2	
assembled	RX40.2.1	
Separator, middle		
unassembled	RX40.1	
assembled	RX40.1.1	
Shelves		
	X	
Width	Part No.	Part No.
X [mm]	unassemb.	assemb.
028	520.028	521.028
053	520.053	521.053
078	520.078	521.078
103	520.103	521.103

RX E-Tubes | Series RX40 | Accessories | Interior Separation

- Separators - Separation of the large interior cross section with cable-friendly polymer separators Part. No. **RX40.2/RX40.1** and horizontal shelf Part No. **520.XX**

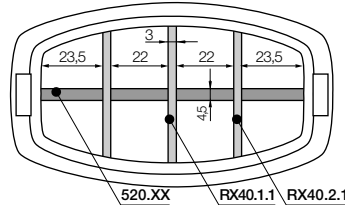

RX E-Tubes | Series RX40 | Accessories | Guide trough

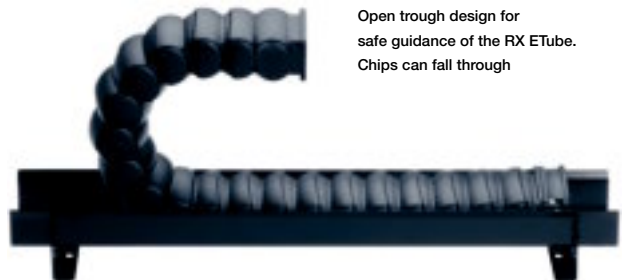

Open trough design for safe guidance of the RX ETube. Chips can fall through



Mounting brackets for RX40

- Universal mountable with attachment capability on all sides
- Mounting brackets (optionally with strain reliefs)
- Perfect fastening with flange mounting brackets
- Easy to open

Moving end
RX401.100.1

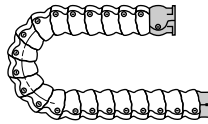

RX401.100.2
Fixed end



Flush mounting
option

RX401.100.1
Moving end

RX401.100.2
Fixed end

**Dimensions and
order configurations**

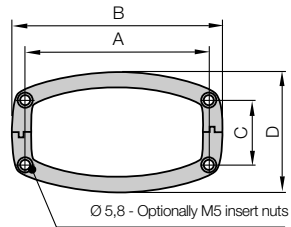
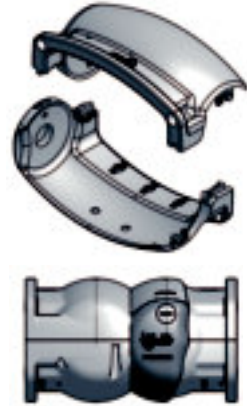
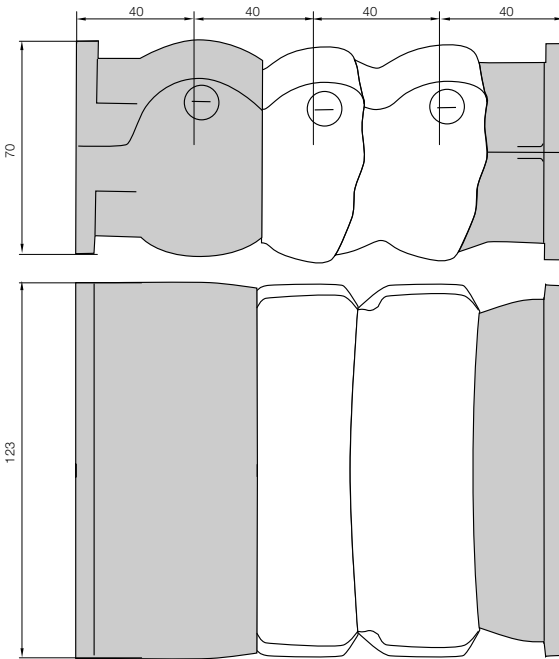

For Series	Part No. full set	Dim. A [mm]	Dim. B [mm]	Dim. C [mm]	Dim. D [mm]
RX40. ▶	RX401.100.12	108	123	38	70

Full set, for both ends:

RX401.100.12 | M5

Single-part order:

RX401.100.1 | M5

Mounting bracket (Moving end)

RX401.100.2 | M5

Mounting bracket (Fixed end)

Phone +49- (0) 22 03-96 49-800
Fax +49- (0) 22 03-96 49-222



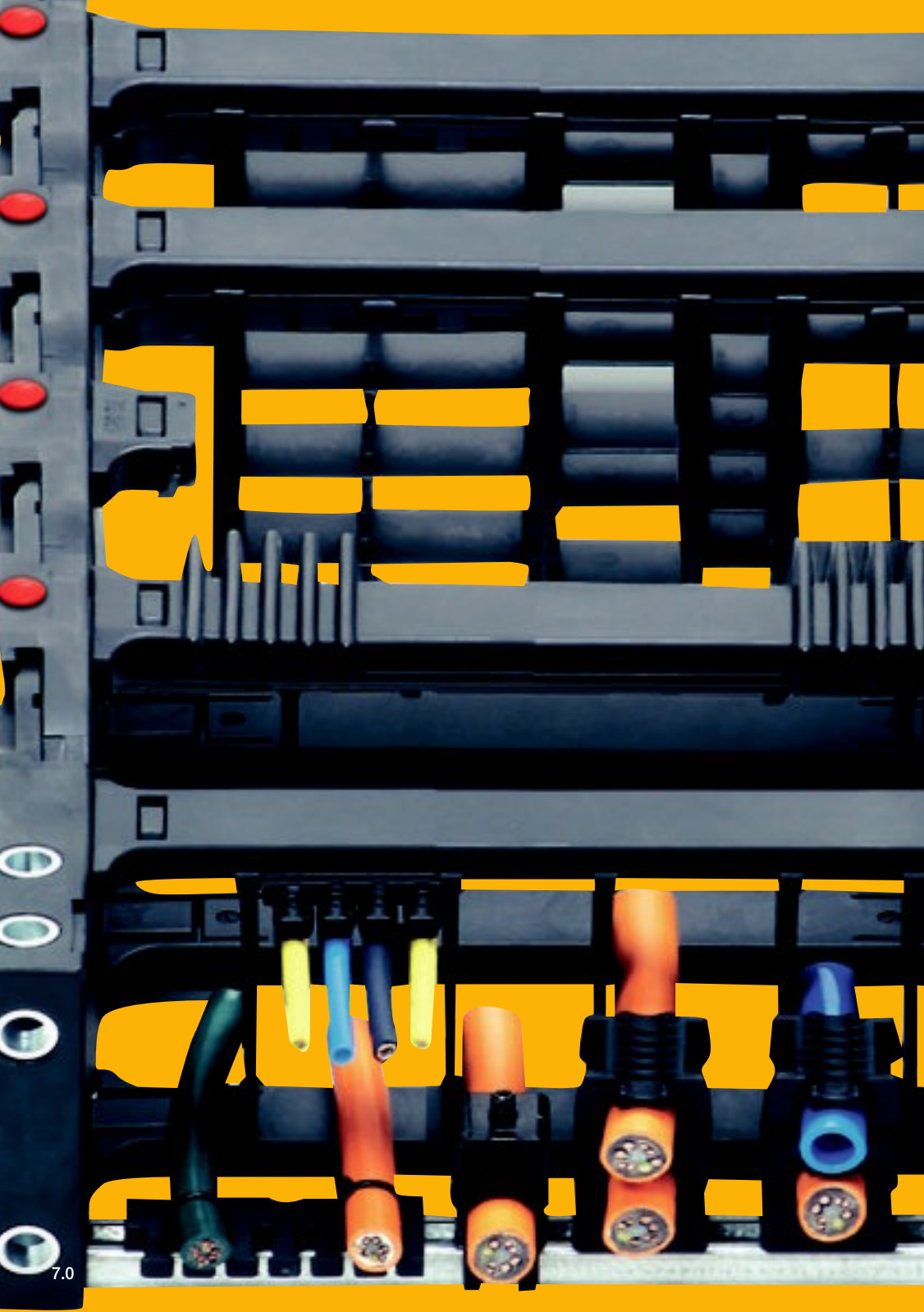

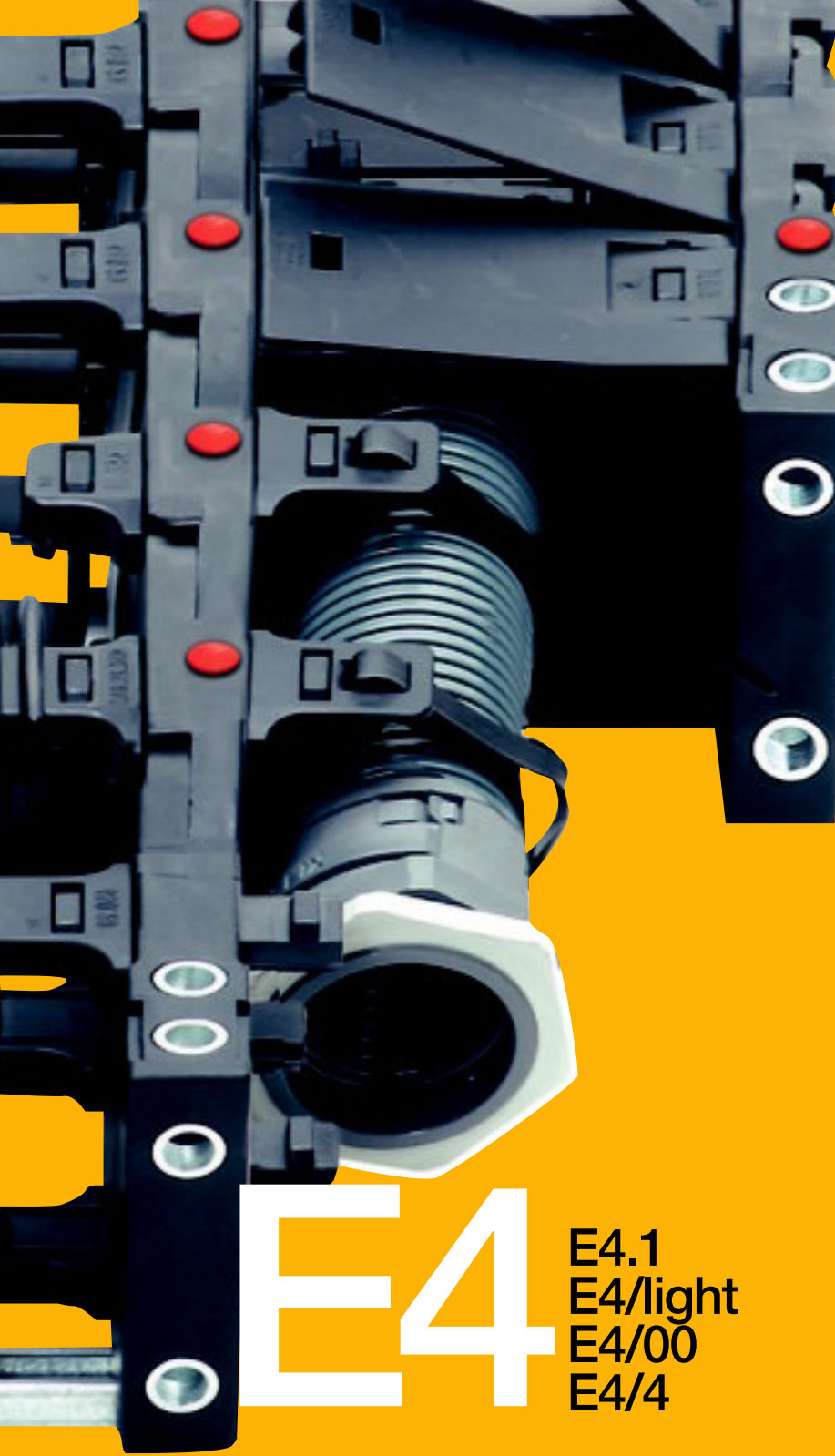

E4

- E4.1
- E4/light
- E4/00
- E4/4

Recommended for all applications: System E4.1



E4.1 ▶ from page 7.6

Whatever application you have, the E4.1 system is almost always the right solution - long travels, large unsupported lengths, simple installation and quiet operation.

- Combines all design features of the systems E4/00 and E4/4 in a single family
- Interlocking side links for optimum lateral stability, for high push/pull force on long travels
- Ideal for side-mounted applications by the undercut design
- Large unsupported lengths by stable, double stop dog
- Noise dampening "brakes" and rubber dampers as additional noise-reducing option
- Stable crossbars with "double" lock
- Outer and inner links for fast assembly
- Extension links for practically "endlessly" wide E-Chains®



E4/light ▶ from page 7.118

Low weight, stable and cost-effective.

Smaller outer links for reduction of weight and costs

- For short travels and hanging/standing applications
- With undercut for high stability
- Cost saving by "light design"
- Optimized ratio of interior and exterior dimension
- Stable crossbars with "double" lock

E4/00 and E4/4 are still available!



E4/00 ▶ from page 7.156

The predecessor of the E4.1 system for low-noise operation and simple installation. E4/00 continues to be available on the long term. Please select the igus® E4.1 system for new designs.







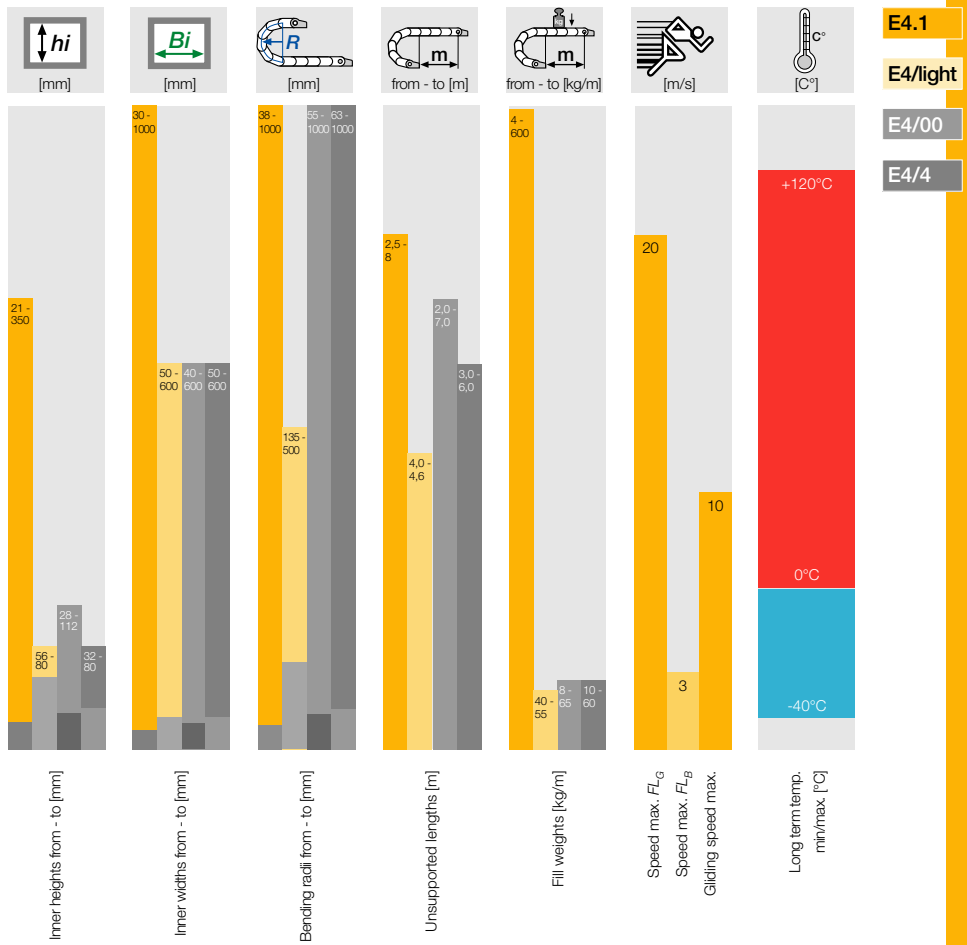

E4/4 ▶ from page 7.218

The predecessor of the E4.1 system for long travels and side-mounted applications. E4/4 continues to be available on the long term. Please select the igus® E4.1 system for new designs.









Interior separations - New Interior separation kit for E4.1 - Standard for new designs



 <p>Standard separator, wide foot</p>	 <p>Separator for ClickLock crossbar</p>	 <p>Separator, narrow foot</p>	 <p>Symmetrical separator</p>	 <p>Notch separator the new notch crossbar</p>	 <p>Full-width shelf, lockable</p>
---	---	---	--	---	--







Still available: Conventional interior separations



 <p>Vertical separator, wide foot</p>	 <p>Vertical separator, slotted</p>	 <p>Mobile plate</p>	 <p>Side plates</p>	 <p>Spacers for E-Chains®</p>	 <p>Shelves</p>
---	--	---	--	--	---







Mounting brackets



 <p>With attachment capability on all sides</p>	 <p>Mounting brackets with strain relief</p>	 <p>Mounting bracket with pivoting</p>	 <p>Aschlusselemente Kandelnd</p>	 <p>Mounting bracket with locking</p>	 <p>Mounting bracket made of steel</p>
---	---	---	--	--	--







Strain relief elements



 <p>Improved housing foot clamp for easy fit into C-profile</p>	 <p>Integration with igus® K mounting brackets possible</p>	 <p>Clip-on tiwrap plates for opening crossbars</p>	 <p>Tiwrap plates with clip-on connection for the C-profile</p>	 <p>Chainfix clip - Modular snap-on for the C-profile</p>	 <p>Chainfix Nugget</p>
---	--	--	--	--	---







Guide troughs

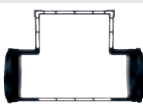

 <p>Aluminum "SuperTrough"-Basic</p>	 <p>Aluminum "SuperTrough"-Heavy-Duty</p>	 <p>Fixed end module, aluminum "SuperTrough"</p>	 <p>Steel guide troughs</p>	 <p>Fixed end module, steel guide trough</p>	 <p>For support of the lower run - Support tray tool kit</p>
--	--	---	--	---	--

Additional features ▶ use product link on each page for details



 <p>Crossbar with Clicklock mechanism</p>	 <p>Extender crossbars</p>	 <p>Extender crossbars</p>	 <p>Hinged crossbars</p>	 <p>SnapClip</p>	 <p>K-CE crossbars</p>
---	---	---	---	---	--

Application Profile

Application	E4.1	E4/light	E4/00	E4/4
High tensile forces	++	o	+	+
High shearing forces	++	o	+	++
Long unsupported length through special stop dogs, undercut	++	+	+	++
Unsupported length, straight	++	o	+	+
Unsupported length, with sag	++	+	+	+
Unsupported, side-mounted	++	+	+	++
Gliding, side-mounted	++	+	+	++
High speeds	++	++	+	+
High accelerations	++	++	+	+
Ratio of inner dimension to outer dimension (space required)	+	++	+	+
Low fill weight required	+	++	+	o
Zig-zag applications	+	-	-	+
Rotary motions	++	o	+	++
Hanging and standing installation	++	++	o	+
Installation space	++	++	o	+
Environment				
Rolling noise generation	++	+	++	+
Gliding noise generation	++	+	++	+
High, constant humidity and temperature	++	-	+	++
Dirt resistance	++	++	++	++
Chip protection	++	+	++	++
Insensitivity to vibration and shock	++	-	++	++
Closed exterior and stop dogs	++	++	++	++
ESD, ATEX (Special version in conductive material)	++	++	o	++
Cleanroom	++	++	++	o
Service life				
Unsupported, straight	++	++	++	++
Unsupported, with sag	++	+	++	+
Gliding	++	+	++	++
Increase service life of cable	++	++	++	++
Installation				
Opening/closing	++	++	++	++
Separating/joining	+	+	++	o

++ very well-suited
 + well-suited
 o conditionally suitable
 - not suitable

System E4 + accessories = many possibilities

- ① **Rol E-Chain®** - Major reduction in drive power to less than 25% for moving the E-Chain®
- ② **AUTO-GLIDE®** - for long travels without guide troughs
- ③ **Optimal low-noise solution**, with rubber pads, in the igus® System E4-program
- ④ **Extender Crossbar** - outer link suited for attaching an additional conduit
- ⑤ **E4 ReadyChain®** - Plug-and-Play EChainSystems® - all inclusive





E4.1

The new standard
in the E4 range!

E4.1 - ONE E-Chain® series for almost all applications

The E4.1 system combines all the advantages of its three predecessors. E4.1 profits from 25 years of igus® experience in 4-piece E-Chains® and is the best igus® E-Chain® in the product range. The E4.1 series is more stable with the same or smaller dimensions than their predecessors. Almost all accessory components and mounting dimensions are identical. With the E4.1, the service life of your application can be still increased with lower costs.

- Undercut design for ideal lateral stability, high shear force on long travels and for large unsupported lengths
- Well suited for side-mounted applications
- Noise dampening "brakes" and rubber dampers as additional noise-reducing option
- Outer and inner links for quick assembly, with or without pretension
- Dirt repellent, with smooth, wear-resistant surface
- Side wear pads

Typical industries and applications

- Crane ● Indoor crane ● Composting plants
- Sewage plants ● Machine tools ● General mechanical engineering ● Materials handling technology ● Refrigeration engineering ● Construction machinery ● Wood working ● Any type of machines ● Robotics and handling systems



Cleanroom test
upon request



Noise optimized due to special
rubber neeps and special stop dog design



ESD classification: Electrically conductive
ESD/ATEX version upon request



System E4.1 proved
with long travels



E-Tubes available as special design
with HT material for 850°C hot chips

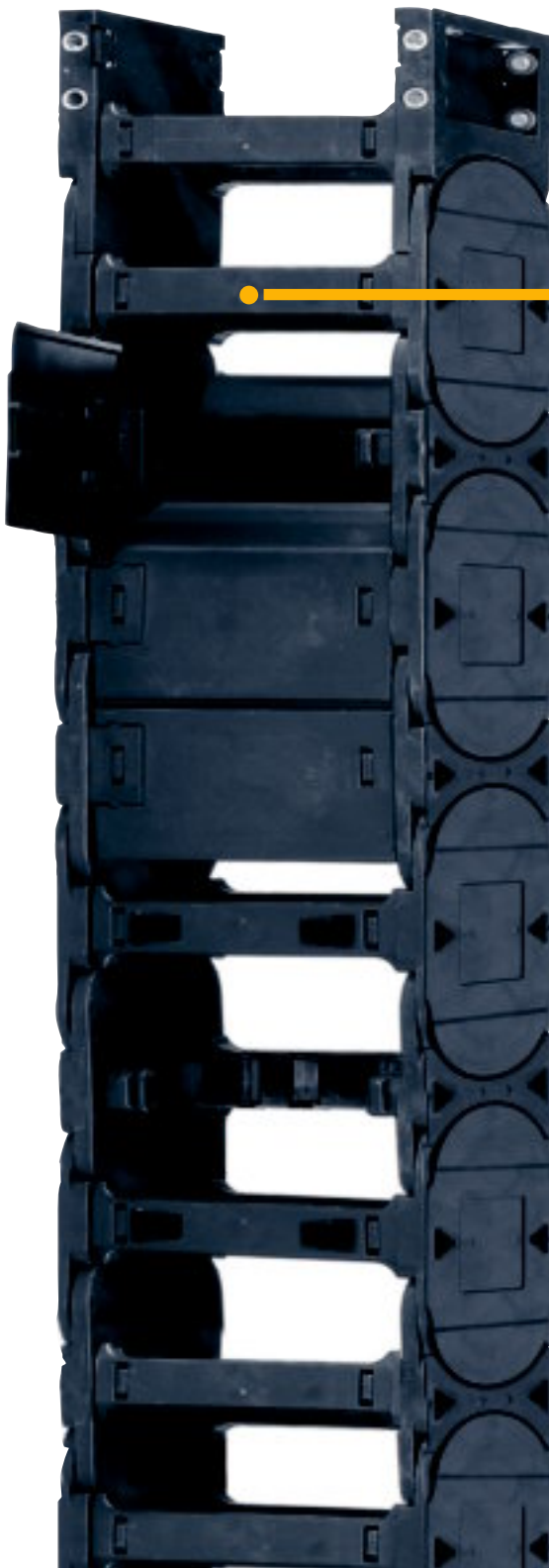



The E4.42 series in a machine tool, completely assembled with igus® Chainflex® cables

Application	Design feature
Large unsupported length	Special stop dogs, undercut
Low-noise operation, unsupported gliding	Integrated "brake", smooth gliding surfaces - rubber dampers optional
Hanging and standing installation	Torsional stability through undercut, "no camber" option by flipping the outer link
Long travels	High push/pull forces through undercut design and stop dogs, large and smooth gliding surfaces
Side-mounted, unsupported	Undercut increases unsupported length by about 30% mounted on the side
Fast assembly	"Inner link/outer link" design
Rotary motion	Through simple flipping of links or easy modification, gliding surfaces on the side
Increase service life of cable	Smooth, wide solid polymer support for cables, many quick-mounting shelving options
Increase service life of chains	Large pins, optimized material, high stability
ESD, ATEX	Undercut for secure contact surfaces in motion (special version in conductive material)
Operation under dirt, chips, humidity	Undercut design prevents chain breakage, dirt-resistant design

You can "do away" with expensive additional components with E4.1 E-Chains® - Convincing durability and stability

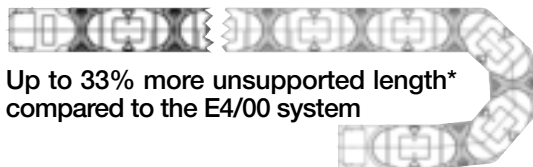

Up to 33% more unsupported length* compared to the E4/00 system

- Up to 133% higher tensile strength*
- Up to 33% more unsupported length*. Save in the purchase cost, as you can now use smaller E-Chains®
- Due to the large unsupported lengths or loads, oversized energy supply systems can be optimized with the igus® E4.1 system
- Best of class - Utmost stability** compared to other polymer E-Chains®

* Compared to the igus® E4/00 system series

** Test at igus® laboratory: Sag tested with defined weight and length over 96h

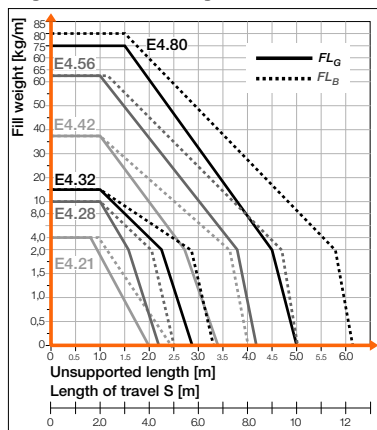

The design principle of the undercut combined with the inner/outer-link solution - Series E4.1 - All applications with one E-Chain®

Smooth, cable-friendly inner surfaces

Low noise operation through integrated "brake" on the radial stop dogs

Smooth and wear-resistant gliding surface - with no additional gliding shoe

ESD version ideal through "tongue and groove" contact

Lateral wear pads for a long service life

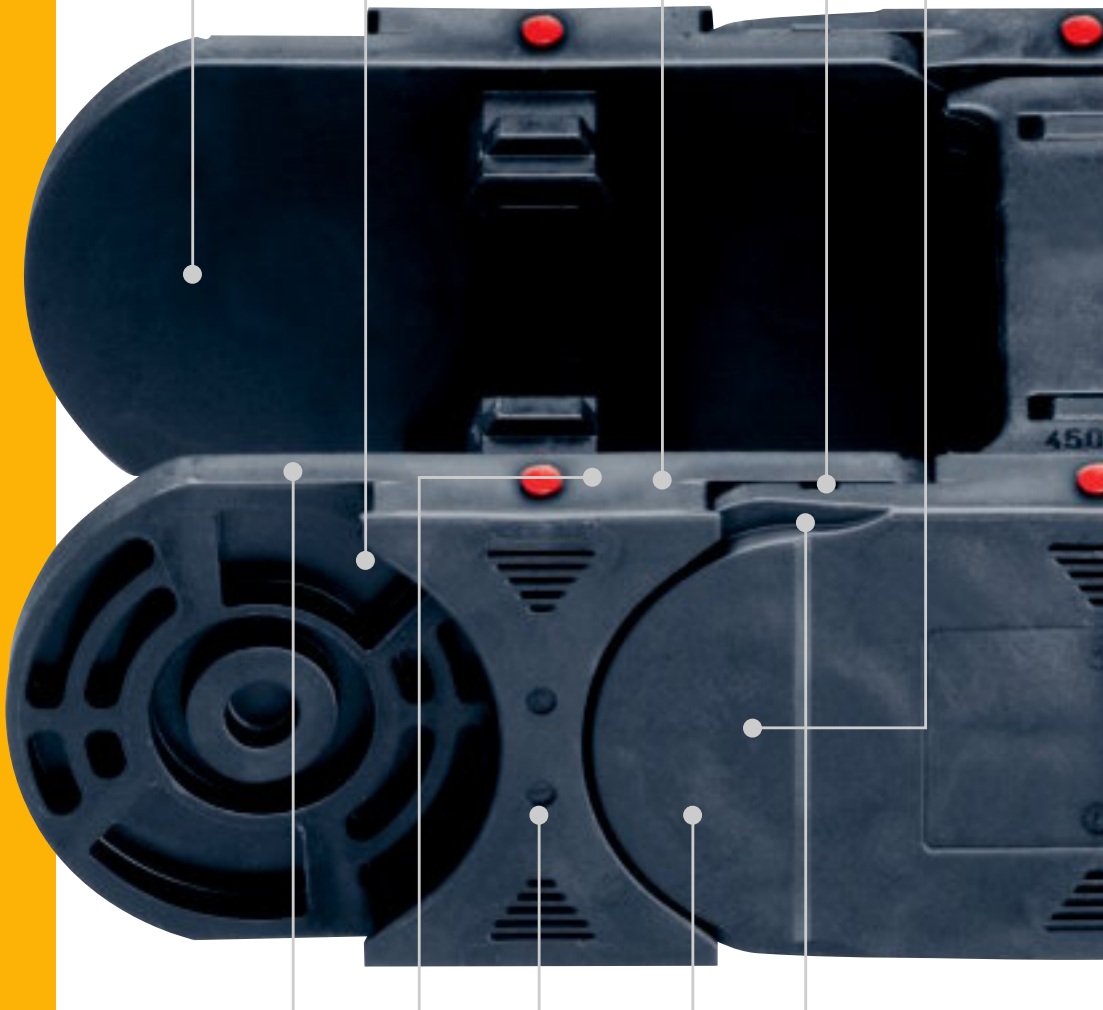

Special chain link contour provide for low rolling noise

Additional noise-reducing option with rubber dampers

Straight run and fast assembly by inner-/outer-link design

Very high stiffening and carrying capacity when shear forces are at work by the undercut design



Stable cross-bars with double locking

Types "with" or "without camber" by flipping outer links

Cable-friendly, rounded crossbar

Vertical stop dog system for larger unsupported lengths

Still more unsupported length with the igus® XXL plastic*

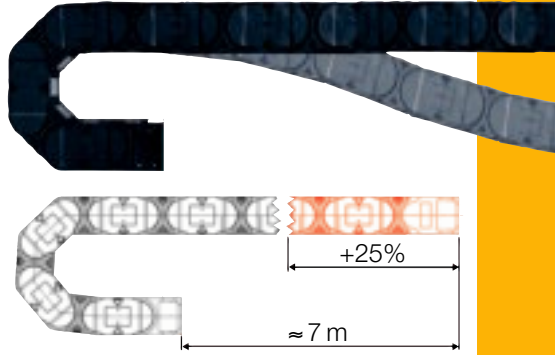

Up to 25% more unsupported length

The new igus® XXL material for igus® E4.1 E-Chains® offers you the potential to implement 7 m travel without troughs and supports, or to implement higher fill weights with constant unsupported length.

- Larger unsupported lengths
- Higher fill weights
- Eliminates guide troughs and supports
- Less space requirement

*optional upon request

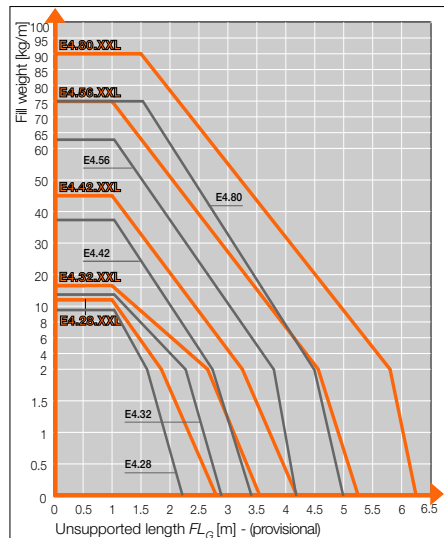

For detailed information:

www.igus.de/en/XXL-Material

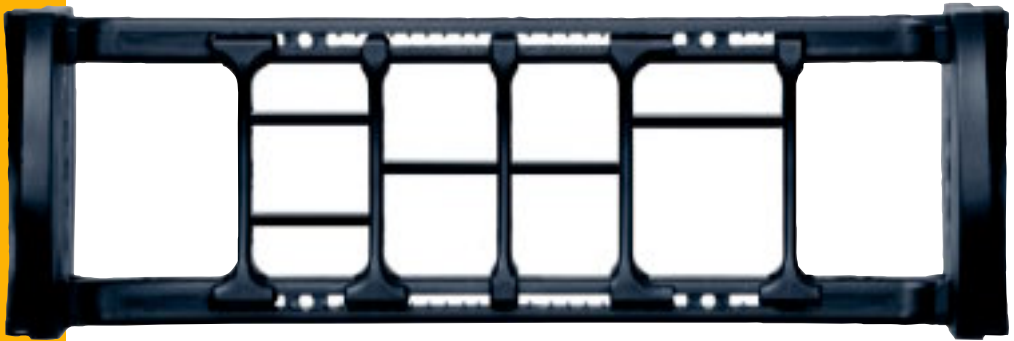

Realize a better separation, with fewer, standardized parts

Optimized and extended interior separation range for E4.1. The very cable friendly design increases your cables cycle life even further.

- Same separation for E-Chains® and E-Tubes
- Safe force closure connection
- Cable friendly plastic crossbars, optimized for low cable wear and long cycle life
- Fast assembly

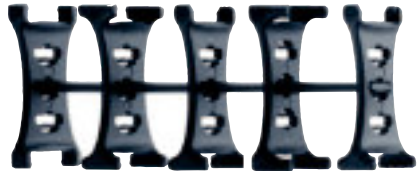

For horizontal separation: full-width shelf

- Shelf locks safely into separators on both ends by special locking clip
- Separators can be moved freely over the shelf in horizontal direction
- No side plates necessary
- Multilayer separation continuous or in single divisions with only one part possible

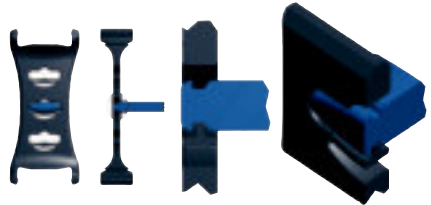

Notch crossbars, notch bottoms and lids*

New standardized crossbar. Notch teeth in 5 mm gaps on the crossbar ensure safe fit against the notch separators, for side-mount applications. The additional, plane surface scaling makes exact positioning of the separator easy, without increasing cable wear.

- No additional distance pieces necessary
- Approx. 25 kg holding force of separator in raster position
- Clearly visible, plane scaling
- Clearly notches and scaling on crossbars for E-Chains® and bottoms and lids of E-Tubes



*First few sizes available. Completion of the product range by the end of 2009





Cables last up to 4 times longer

The new separators can increase cycle life of cables by a factor of 4 - their rounded foot ensures a smooth junction to the crossbar and avoids edges, which could increase cable wear. A strong force closure fit for E-Chains® and E-Tubes.

Tests in the igus® lab have shown the lowest cable wear in E-Chains® with the new plastic separators.

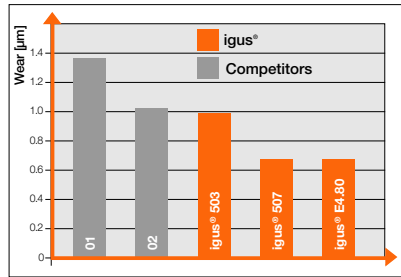

Wear on plastic separators. Wear could be reduced to nearly half with the new separators

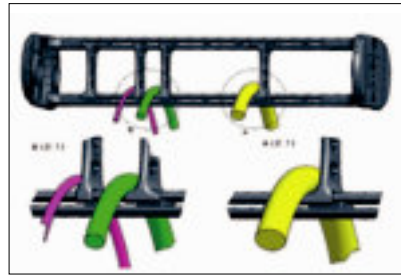

Optimized, cable friendly separator geometry



Longer life with Polymer Crossbars

Tests in the igus® lab have shown, that minimized cable wear is achieved in E-Chains® with plastic crossbars which are designed cable friendly, with rounded contours. All igus® E-Chains® and E-Tubes are equipped with plastic crossbars. Where it makes sense, other material can be considered, subject to prior test runs. The locking strength of igus® crossbars is also convincing. Crossbars from different materials underwent a pull-out strength test in the igus® lab. The locking strength is evident. Also, plastic crossbars are elastic yet very torsion resistant and do not plastically deform, like i.e. aluminum crossbars.

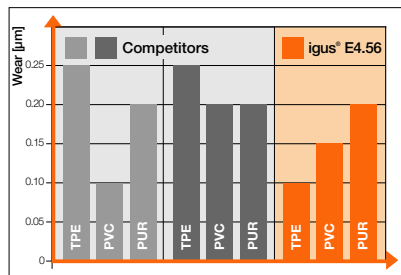

Longest service life with igus® polymer crossbars

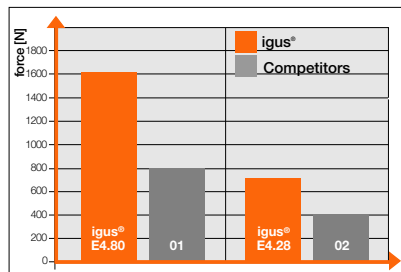

Retention force comparison polymer-/aluminum-crossbars - Longest service life! Maximum holding force of the crossbars

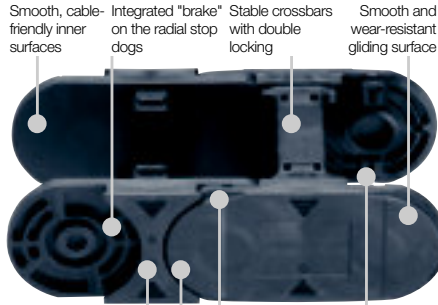

"Inner link/outer link" design for a quick assembly
 Very high stiffening and carrying capacity by the undercut design
 Vertical stop dog system for larger unsupported lengths

E4.1 - All applications with one E-Chain®

- The design principle of the undercut combined with the inner/outer-link solution - Series E4.1
- Available in 40 width sizes as both E-Chain™ and E-Tube
- Interlocking side links for optimum lateral stability, for high push/pull force on long travels
- Large unsupported lengths
- Noise-dampening "brake" and rubber dampers as additional noise-reducing options
- "Inner link/outer link" design for a quick assembly, various interior separation options
- To be opened from both sides - stable crossbars with double locking
- "Inner link/outer link" design for a quick assembly
- Support Tray tool kit for the support of the lower run ► [page 9.70](#)
- You find more technical data about the material, chemical resistance, temperatures ► [chapter design, from page 1.38](#)

Selection table

Series	Inner height <i>hi</i> [mm]	Inner width <i>Bi</i> [mm]	Outer width <i>Ba</i> [mm]	Outer height <i>ha</i> [mm]	Bending radius <i>R</i> [mm]	Unsupported length max. [m]	Page
--------	--------------------------------	-------------------------------	-------------------------------	--------------------------------	---------------------------------	-----------------------------	------

Crossbars every link for particularly demanding applications



E4.21 (210*)	21	30 - 120	44 - 134	28	38 - 200	2,50	7.16
E4.28	28	40 - 300	60 - 320	42	55 - 250	2,50	7.24
E4.32	32	50 - 400	73 - 423	54	63 - 300	3,30	7.34
E4.42	42	50 - 400	76 - 426	64	75 - 350	4,00	7.48
E4.56	56	50 - 600	84 - 634	84	135 - 500	5,00	7.62
E4.80	80	50 - 600	100 - 650	108	150 - 1000	6,20	7.76
1640*	112	50 - 600	84 - 634	140	200 - 600	4,5	7.90
800*	200	200 - 600	260 - 660	236	325 - 1000	8,00	7.100
840*	204	100 - 563	160 - 623	236	325 - 1000	8,00	7.106
E4.350	350	200 - 1000	340 - 1140	450	500 - 1000	6,2	7.112

Crossbars every 2nd link for almost all applications



H4.32	32	50 - 400	73 - 423	54	63 - 300	3,30	7.34
H4.42	42	50 - 400	76 - 426	64	75 - 350	4,00	7.48
H4.56	56	50 - 600	84 - 634	84	135 - 500	5,00	7.62
H4.80	80	50 - 600	100 - 650	108	150 - 1000	6,20	7.76

E-Tubes fully enclosed, excellent cable protection



R4.28	28	50 - 300	70 - 320	42	75 - 250	2,50	7.24
R4.32	32	50 - 300	73 - 323	54	125 - 300	3,30	7.34
R4.42	42	50 - 300	76 - 326	64	125 - 350	4,00	7.48
R4.56	56	75 - 462	109 - 497	84	150 - 500	5,00	7.62
R4.80	80	200 - 400	250 - 450	108	200 - 1000	6,20	7.76
R1608*	112	200 - 400	234 - 434	140	250 - 600	4,5	7.90

*Due to its special design principle, the proven and tested series 210, 1640/R1608, 800 and 840 were included in the E4.1 range!

E4.1 | Opening E-Chains®

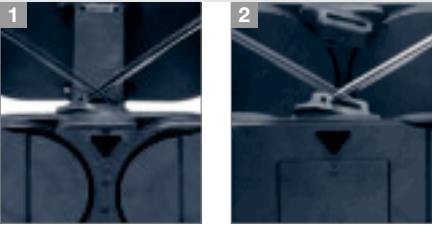

Remove crossbars - Insert screwdriver into the slot, push down, release by lever action

Remove clips - Insert screwdriver into the slot and push down, release by lever action

E4.1 | Opening E-Tubes

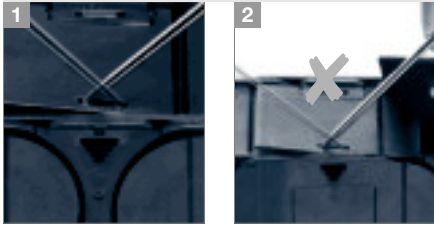

Remove lids/bottoms - Insert screwdriver into the slot, release by lever action

Release **only one side** to swivel the lid

E4.1 | Assembling E-Chains® and E-Tubes

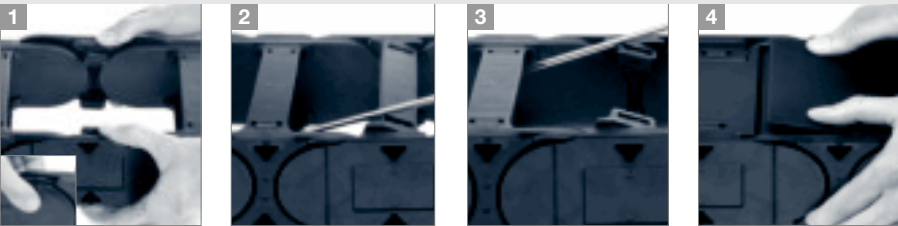

Line up two inner side links, side by side. Attach an outer side link between

Assemble crossbars - Push down and snap in by using a screwdriver

Assemble clips (E-Chains® with crossbars every other link) - Push down and snap in

Assemble E-Tube lids/bottoms - Attach to the connector at an angle - Snap in

E4.1 | Separating E-Chains® and E-Tubes

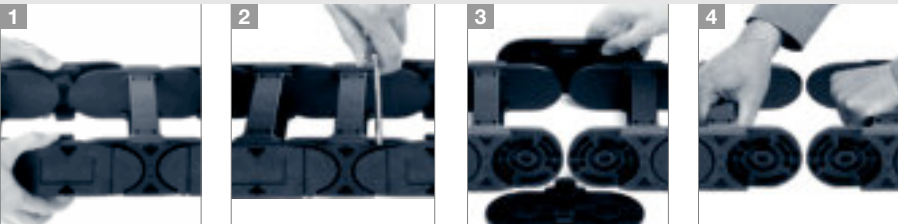

Remove crossbars, clips, lids and bottoms at the outer links...

Guide the screwdriver into the slot between side links and release it by levering

Remove the outer links to the side...

...and separate the E-Chain®

Reduce installation times, simplify processes - QuickLock crossbar

Crossbars can be assembled and installed in seconds:
 Snap-open QuickLock system of the crossbars = 25% faster assembly than with standard crossbars!
www.igus.de/en/E4schnelleMontage





Price index

Low noise version
 available with special
 rubber pads design

Cleanroom test
 upon request

ESD classification:
 Electrically conductive ESD/ATEX
 version upon request

Opening E-Chains: Remove crossbars and clips - Insert screwdriver into the slot, push down, release by lever action

When to use the Series E4.21:

- If a low-noise version is required
- At very high speeds and/or accelerations
- For long travels
- For high additional loads

When not to use it:

- When an extremely low vibration E-Chain® is required
- ▶ **Series E3.22, page 8.18**
- When a one-sided snap open E-Chain®/ E-Tube is required for economic reasons
- ▶ **Series 1400/1450/1480/1500, page 5.92**
- When one-sided snap open E-Tubes are required at a low price
- ▶ **Series R117/R118, page 6.6**

- ① Straight run through inner-/outer-link design
- ② Low-noise operation through integrated brake in the radial stop dog system
- ③ By the undercut design, very high stiffening and carrying capacity when shear forces are at work
- ④ 15% more tensile strength (compared to the best old E4 series), better unsupported length through improved stop dog system and vertical radial stops
- ⑤ Crossbars are removable along both radii
- ⑥ Wide, rounded plastic crossbars - cable friendly
- ⑦ Optimized glide pads - long service life
- ⑧ Smooth outline, dirt repellent
- ⑨ Interior separation with standard locking separator
- ⑩ Strain relief with strain relief separators in the mounting bracket are available
- ⑪ Mounting brackets pivoting on one side with all-round attachment option
- ⑫ E-Chains® also available with reverse bending radius "RBR"

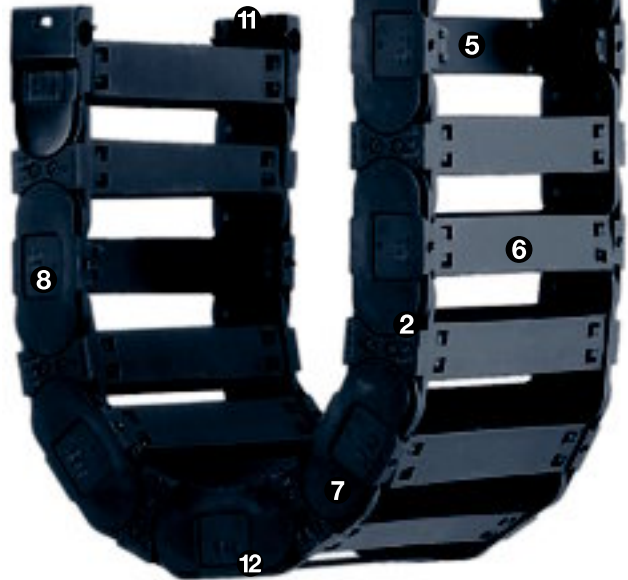
Order example complete E-Chain®

 Please indicate chain-lengths or number of links **Example: 2 m or 66 links**

 2 m **E4.21.120.100.0**

E-Chain®

 with 2 separators **T2112** assembled every 2nd link

Interior separation

 1 set **E4.210.120.1.12**

Mounting bracket

Unsupported length

FL_G = with straight upper run

FL_B = with permitted sag

Further information ► **Design, page 1.12**

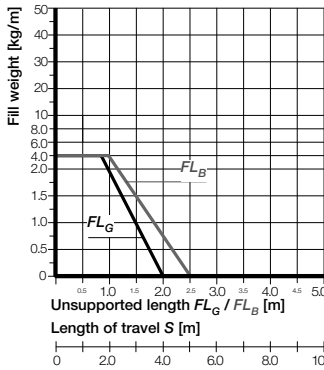
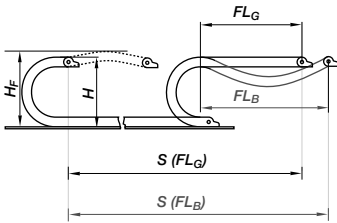

- S = Length of travel
- R = Bending radius
- H = Nominal clearance height
- H_F = Required clearance height
- H_{R1} = Trough inner height
- D = Overlength E-Chain*
radius in final position
- $K = \pi \cdot R + \text{"safety"}$
- D_2 = Over length - long travels, gliding
- K_2 = *Further add-on
- H_2 = *Mounting height

*if the mounting bracket location is set lower

Other installation methods

- Vertical, hanging ≤ 40 m
- Vertical, standing ≤ 3 m
- Side mounted, unspupp. ≤ 1 m
- Rotary requires further calculation
- Unsupported length of upper run = upon request

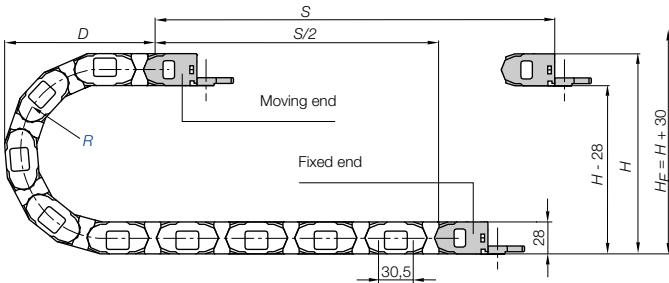

Pitch = 30,5 mm/link Links/m = 33 (1007mm) Chain length = $S/2 + K$

R	038	048	063	075	100	150	200
H	104	124	154	178	228	328	428
D	085	095	110	120	145	195	245
K	185	215	260	300	380	535	690
H_2	104	124	154	178	135	135	135
D_2^{*25}	085	095	110	120	490	530	665
K_2	185	215	260	300	782	920	1104

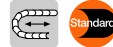

Short travels - unsupported

Unsupported E-Chains* feature positive camber over short travels. This must be accounted for when specifying the clearance height H_F . Please consult igus* if space is particularly restricted.

The required clearance height:
 $H_F = H + 30$ mm
(with 1,5 kg/m fill weight)

Long travel lengths from 10 m to max. 120 m Chain length = $S/2 + K_2$

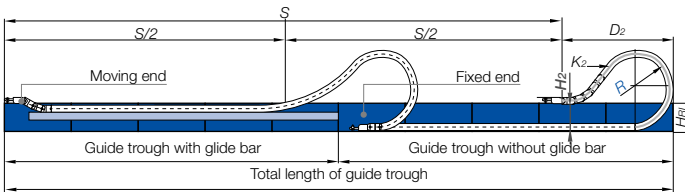

In case of travels between 4 and 10 m we recommend a longer unsupported length.



Gliding, long travel applications (max. 120 m)

In this case the E-Chain* upper run will be introduced in a guide trough on the lower run. We recommend to realize the engineering of such a plant by our technicians.

Technical Data

Speed / acceleration FL_G	max. 20 [m/s] / max. 200 [m/s ²]
Speed / acceleration FL_B	max. 3 [m/s] / max. 6 [m/s ²]
Gliding speed / acceleration (maximum)	max. 10 [m/s] / max. 50 [m/s ²]
Material - permitted temperature °C	igumid G / -40° up to +120° C
Flammability class, igumid G	VDE 0304 IIC UL94 HB



Details of material properties
► page 1.38

For support of the lower run - **Support Tray tool kit** available ► page 9.70

21

System E4.1
Inner height: 21 mm

Phone +49- (0) 22 03-96 49-800
Fax +49- (0) 22 03-96 49-222



► page 7.15

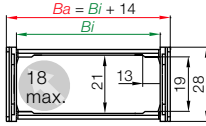

Part No. structure

E4.21.120.100.0



Standard Series E4.21 - E-Chain® with crossbars every link

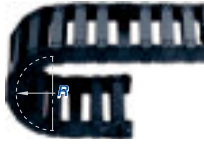

- Robust solution with crossbars every link
- Can be opened from two sides
- Removable crossbars
- Separator for locking crossbar (fixable) Standard



Phone +49- (0) 22 03-96 49-800
 Fax +49- (0) 22 03-96 49-222



Order-key for further options and versions for this series ► page 7.22

E4.21 (Serie 210)

Part No.	<i>Bi</i> [mm]	<i>Ba</i> [mm]	Weight [kg/m]
E4.21.030.□.0 (210.030.□.0)	30	44	≈ 0,60
E4.21.040.□.0 (210.040.□.0)	40	54	≈ 0,64
E4.21.050.□.0 (210.050.□.0)	50	64	≈ 0,67
E4.21.060.□.0 (210.060.□.0)	60	74	≈ 0,71
E4.21.070.□.0 (210.070.□.0)	70	84	≈ 0,74
E4.21.080.□.0 (210.080.□.0)	80	94	≈ 0,78
E4.21.090.□.0	90	104	≈ 0,82
E4.21.100.□.0 (210.100.□.0)	100	114	≈ 0,85
E4.21.110.□.0	110	124	≈ 0,89
E4.21.120.□.0 (210.120.□.0)	120	134	≈ 0,92

Available bending radii

R [mm] 038 048 063 075 100 150 200

Supplement Part No. with required radius. Example: E4.21.120.100.0

0 = standard color, other colors ► page 1.39 · Pitch: 30,5 mm/link - Links/m = 33

igus® GmbH
 51147 Cologne

Part No. E-Chain® links, single parts

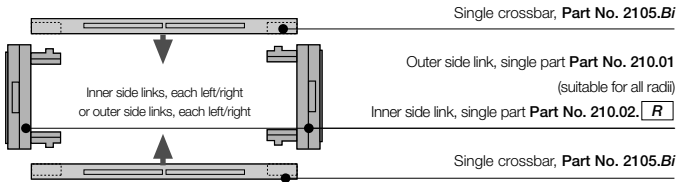
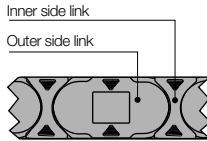

Internet: www.igus.eu
 E-mail: info@igus.de

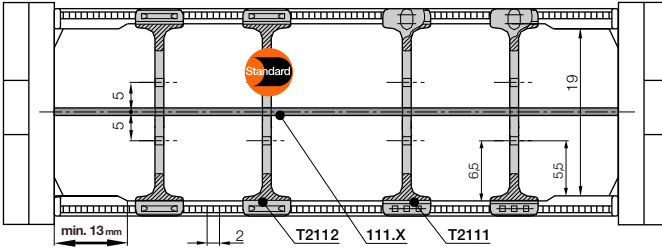

Vertical separators are used if a vertical subdivision is required. In the standard configuration, a separator is mounted at every second E-Chain® link. **Note:** Observe a lateral spacing of at least 13 mm!

Vertical separators

- **Standard separator T2102 for E-Chains®** is used when vertical and horizontal separation is required. Due to its slot, it allows basic vertical/horizontal shelving arrangements.
- **Notch separator T2101 for E-Chains®** can be locked in 2 mm increments due to gaps on the crossbars. The separator cannot slide sideways during operation.
- **Strain relief separator T2103.Z** can be integrated into the mounting bracket and can be placed there at any point. It combines strain relief and interior separation.
- **Full-width shelf 110.X** - this option makes sense in applications with many thin cables with similar diameters. It is based upon vertical separator T2102 and T2101, with inserted full-width shelves.



Vertical separator for E-Chains®	
unassembled	T2102
assembled	T2112

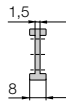

Notch separator for E-Chains®	
unassembled	T2101
assembled	T2111

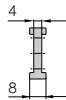

Strain relief separator for E-Chains®	
unassembled	T2103.Z
assembled	T2113.Z



Vertical separator T2102



Notch separator T2101



Strain relief separator T2103.Z



Full-width shelf 110.X

Width X [mm]	Part No. unassembled	Part No. assembled
030	110.30	111.30
040	110.40	111.40
050	110.50	111.50
060	110.60	111.60
070	110.70	111.70

Width X [mm]	Part No. unassembled	Part No. assembled
080	110.80	111.80
090	110.90	111.90
100	110.100	111.100
110	110.110	111.110
120	110.120	111.120

Full-width shelf

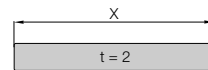

System E4.1
Inner height: 21 mm

Phone +49- (0) 22 03-96 49-800
Fax +49- (0) 22 03-96 49-222



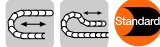

Moving end
E4.210...1.2

The Standard - option polymer, pivoting

- Recommended for unsupported and gliding applications
- KMA mounting bracket with attachment capability on all sides
- Well suited for tight installation conditions
- Integrated strain relief possible
- Variable traverse angle for flexible assembly

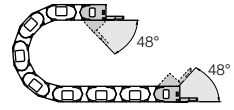

The attachment variants arising automatically by the choice of the KMA mounting bracket

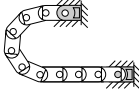

Fixed end
E4.210...1.1

Dimensions and order configurations

Fixed end
E4.210...1.1

Moving end
E4.210...1.2

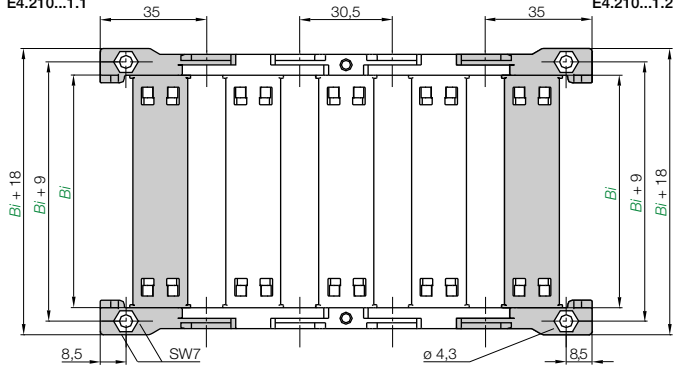

Part No. structure

E4.210.030.1.12



Full set, for both ends:

E4.210.030.1.12

Single-part order:

E4.210.030.1.1

Mounting bracket moving end

E4.210.030.1.1

Mounting bracket fixed end

For	Part No.	Bi
E-Chain [®]	full set	[mm]
.030.	E4.210.030.1.12	30
.040.	E4.210.040.1.12	40
.050.	E4.210.050.1.12	50
.060.	E4.210.060.1.12	60
.070.	E4.210.070.1.12	70

For	Part No.	Bi
E-Chain [®]	full set	[mm]
.080.	E4.210.080.1.12	80
.090.	E4.210.090.1.12	90
.100.	E4.210.100.1.12	100
.110.	E4.210.110.1.12	110
.120.	E4.210.120.1.12	120

Phone+49- (0) 22 03-96 49-800
Fax +49- (0) 22 03-96 49-222

igus[®] GmbH
51147 Cologne

Internet: www.igus.eu
E-mail: info@igus.de



Special feature mounting brackets KMA: Series E4.21

- Mounting brackets with attachment points on all sides
- Special design of the counterbore as hexagon - the inlay of the nut (M4) and the counterboring of the hexagon socket head screw (M4), is consequently possible
- **Attention:** Mounting brackets always need to end with an inner plate (uneven number of links)



Accessories | Strain Relief

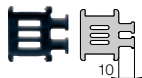

Strain relief separator T2103.Z

- Can be integrated into the connector component and can be positioned as required
- Double-layered strain relief
- It combines strain relief and interior separation.

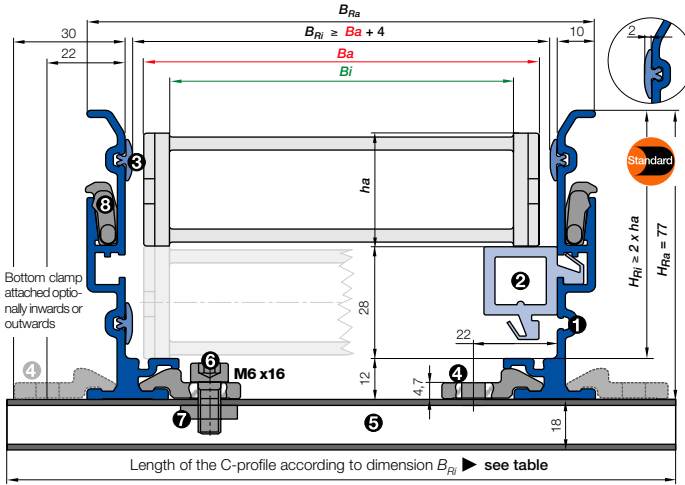

- **Components, trough "Basic":** ① Trough side parts, aluminum, 2 m ② Glide bar, plastic, 2 m ③ Glide strips, plastic, 2 m (without glide strips on request) ⑩ Optional: Silencer profile, rubber
- **Components, installation set "Basic":** ④ Bottom clamp, aluminum ⑤ C-profile, steel galvanized ⑥ Screw M6 x16 ⑦ Sliding nut M6 ⑧ Interface connector, plastic

- B_a = Outer width E-Chains® / E-Tube
 B_i = Inner width E-Chains® / E-Tube
 h_a = Outer height E-Chains® / E-Tube
 H_{Ri} = Inner trough height
 H_{Ra} = Outer trough height
 B_{Ri} = Inner trough width ▶ depends on dim. B_a
 B_{Ra} = Outer trough width
 n_{Mon} = Number of installation sets (left/right)
 n_{Ri} = Number of trough sets (left/right)
 $H_{Ri} \geq 2 \cdot h_a$
 $B_{Ri} \geq B_a + 4$
- = Guide trough set ● = Installation set "Basic"
 ● = Guide bar ● = C-Profile

Installation set "Basic" with C-Profile

Bottom Clamp attached optionally inwards or outwards

E4.21.050.100.0 ▶ Order example

B_{Ri} [mm]	Part No.	
	attached inwards	attached outwards
.030 48	-	960.30.150
.040 58	960.30.125	960.30.150
.050 68	960.30.125	960.30.175
.060 78	960.30.125	960.30.175
.070 88	960.30.150	960.30.175
.080 98	960.30.150	960.30.200
.090 108	960.30.175	960.30.200
.100 118	960.30.175	960.30.225
.110 128	960.30.175	960.30.225
.120 138	960.30.200	960.30.225

Order example: Length of travel 30 m - Center mounted for Series E4.21.050.100.0 with $B_{Ri} = 68$

- Guide trough set (set of 2 trough side parts, incl. glide strips) **without** glide bar
Order text: 16 m Guide trough without glide bar (8 x 2 m sections) Part No. 970.30.SL
- Guide trough set (set of 2 trough side parts, incl. glide strips) **with** glide bar
Order text: 16 m Guide trough with glide bar (8 x 2 m sections) Part No. 970.32.SL
- Installation set "Basic" complete (Guide trough-sets + 1)
Order text: 17 Installation sets "Basic" Part No. 960.30.125
- Option:** For an additional noise dampening with dampening profile, please add Index A Example: **Part No. 970.30.SLA**

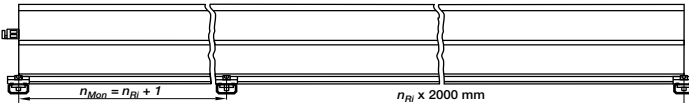

Principle sketch: Number of installation sets to be installed = **Number of trough sections + 1**

Phone +49- (0) 22 03-96 49-800
 Fax +49- (0) 22 03-96 49-222



Standard

Part. No.
Standard
E-Chains®/E-Tubes



E4.21.050.R.0
(Crossbar every link)

Delivery time
24h or today

Additional noise dampening with pads

Part. No.
Low noise (with pads)
E-Chains®/E-Tubes



ES4.21.050.R.0
(Crossbar every link)

Delivery time
3-5 workdays

Easy turning of the outer link without rework

Part. No.
NC-Material
E-Chains®/E-Tubes

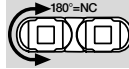

E4.21.050.R.0.NC
(Crossbar every link)

Delivery time
24h or today

Reverse bending radius for circular movements

Part. No.
RBR
E-Chains®/E-Tubes



E4.21.050.R1/R2.0
(Crossbar every link)

Delivery time
3-5 workdays

Unsupported lengths +25% possible

Part. No.
XXL-Material*
E-Chains®/E-Tubes



E4.21.050.R.0.XXL
(Crossbar every link)

Delivery time
1-2 weeks

*Sidebands made from XXL-Material

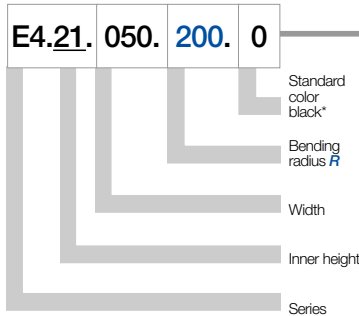
Order example - Standard

All E-Chains® made from igumid G are available in the colors listed in the table. Additional colors are usually feasible. (Standard color black). Colored E-Chains® are basically not available from stock.

Color options for igus® E-Chains® and E-Tubes. Standard color black (from stock)

E-Chains®/E-Tubes	igus® color index	Ral-numbers (approx.)	Delivery time
Material color			
black	Index .0	⇒ RAL 9004	from stock
white*	Index .1	⇒ RAL 9003	2-4 weeks
violet*	Index .5	⇒ RAL 4008	2-4 weeks
yellow*	Index .4	⇒ RAL 1018	2-4 weeks
orange*	Index .2	⇒ RAL 2003	2-4 weeks
red*	Index .6	⇒ RAL 3002	2-4 weeks
blue*	Index .8	⇒ RAL 5005	2-4 weeks
green*	Index .7	⇒ RAL 6011	2-4 weeks
grey*	Index .3 (E-Chains®)	⇒ RAL 7023	2-4 weeks
dusty grey*	Index .3 (E-Tubes)	⇒ RAL 7037	2-4 weeks
agate grey*	Index .11	⇒ RAL 7038	2-4 weeks
light grey*	Index .14	⇒ RAL 7035	2-4 weeks
black grey*	Index .13	⇒ RAL 7021	2-4 weeks
yellow/black*	Index .9	–	2-4 weeks

*Delivery Time and pricing for colored E-Chains® upon request

ATEX/ESD
classified E-Chains®
- II 2 GD

Part. No.
ESD-Material
E-Chains®/E-Tubes



E4.21.050.R.0.ESD

(Crossbar every link)

*Delivery time
up to 2 weeks*

Combination possibilities, examples:

	Low noise Option	NC-Version	RBR-Version	XXL-Material	ESD-Material
Low noise Option		ES4.21.050.R.0.NC	–	ES4.21.050.R.0.XXL	ES4.21.050.R.0.ESD
NC-Version	ES4.21.050.R.0.NC		–	–	E4.21.050.R.0.ESD.NC
RBR-Version	–	–		–	E4.21.050.R1/R2.0.ESD
XXL-Material	ES4.21.050.R.0.XXL	–	–		–
ESD-Material	ES4.21.050.R.0.ESD	E4.21.050.R.0.ESD.NC	E4.21.050.R1/R2.0.ESD	–	

Price index



Series E4.28 Series R4.28



Low noise version available with special rubber pads design



Cleanroom test upon request



ESD classification: Electrically conductive ESD/ATEX version upon request



Opening E-Chains: Remove crossbars and clips - Insert screwdriver into the slot, push down, release by lever action



Remove lids/bottoms (E-Tubes) - Insert screwdriver into the slot, release by lever action



When to use the Series E4.28/R4.28:

- If a low-noise version is required
- At very high speeds and/or accelerations
- For long travels
- For high additional loads



When not to use it:

- When an extremely low vibration E-Chain*/E-Tube is required
- ▶ Series E6.29, page 8.40
- ▶ Serie R6.29, page 8.46
- When a one-sided snap open E-Chain*/E-Tube is required for economic reasons
- ▶ Series 2400/2450/2480/2500, page 5.102

- 1 Straight run through inner-/outer-link design
- 2 Low-noise operation through integrated brake in the radial stop dog system
- 3 By the undercut design, very high stiffening and carrying capacity when shear forces are at work
- 4 15% more tensile strength (compared to the best old E4 series), better unsupported length through improved stop dog system and vertical radial stops
- 5 Shelving program with a wide range of options
- 6 Version NC "without pretension" simply by turning outer links without rework possible
- 7 Crossbars are removable along both radii
- 8 Hinged snap-open removable lids along outer radius of E-Tube
- 9 Wide, rounded plastic crossbars - cable friendly
- 10 Optimized glide pads - long service life

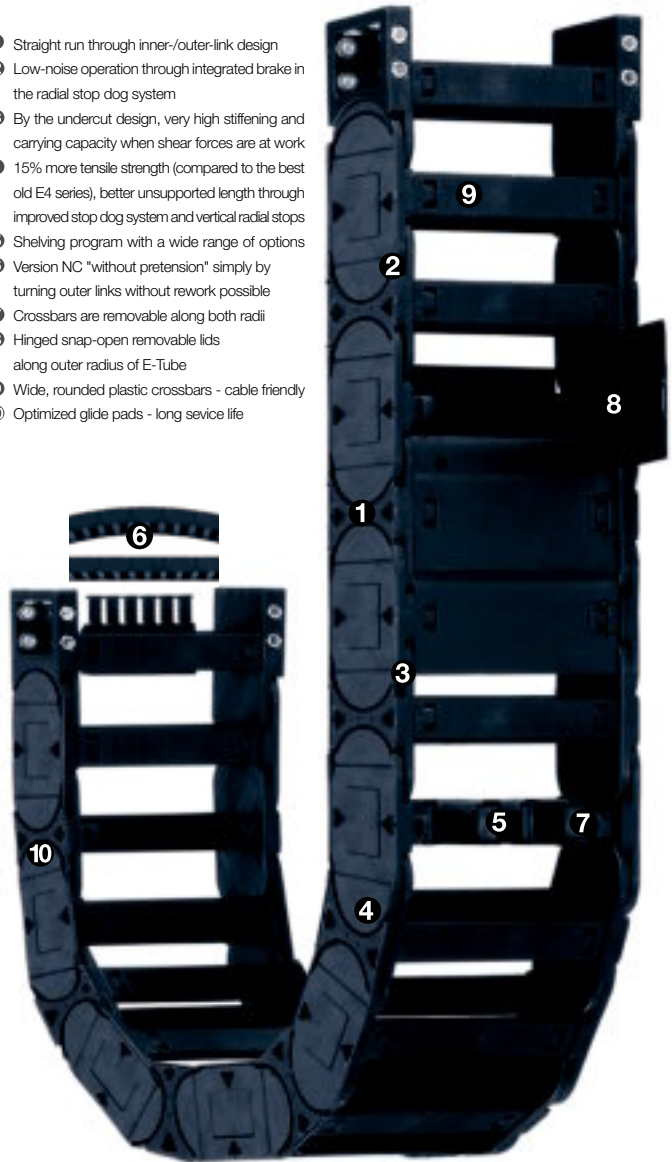

Order example complete E-Chain®

Please indicate chain-lengths or number of links Example: 3 m or 66 links

3 m E4.28.300.250.0

E-Chain®

with 2 separators 2211 assembled every 2nd link

Interior separation

1 set E4.280.300.1.12

Mounting bracket



Unsupported length

FL_G = with straight upper run

FL_B = with permitted sag

Further information ► **Design, page 1.12**

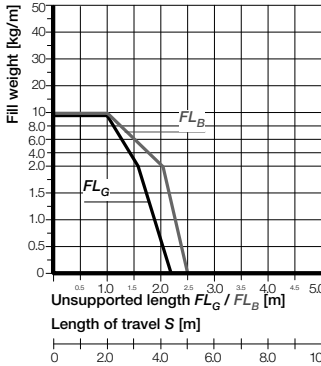
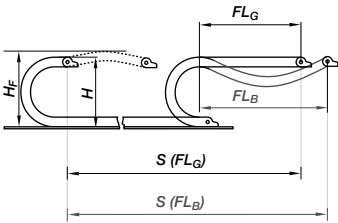

- S = Length of travel
- R = Bending radius
- H = Nominal clearance height
- H_F = Required clearance height
- H_{R1} = Trough inner height
- D = Overlength E-Chain® radius in final position
- $K = \pi \cdot R + \text{"safety"}$
- D_2 = Over length - long travels, gliding
- K_2 = *Further add-on
- H_2 = *Mounting height

*If the mounting bracket location is set lower

Other installation methods

- Vertical, hanging ≤ 80 m
- Vertical, standing ≤ 5 m
- Side mounted, unsp. ≤ 2 m
- Rotary requires further calculation
- Unsupported length of upper run = upon request

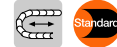

Short travels - unsupported

Unsupported E-Chains® feature positive camber over short travels. This must be accounted for when specifying the clearance height H_F . Please consult igus® if space is particularly restricted.

The required clearance height:
 $H_F = H + 40$ mm
(with 1,0 kg/m fill weight)

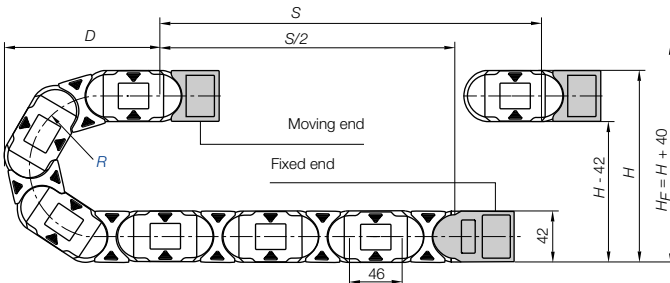

Pitch = 46 mm/link Links/m = 22 (1012 mm) Chain length = $S/2 + K$

R	055	063	075	100	125	150	175	200	250
H	152	168	192	242	292	342	392	442	542
D	122	130	142	167	192	217	242	267	317
K	265	290	330	410	485	565	655	725	880
H_2	152	168	192	158	158	158	158	158	158
D_2^{*25}	122	130	142	350	490	530	665	730	935
K_2	265	290	330	598	782	920	1104	1242	1610

Long travel lengths from 10 m to max. 200 m Chain length = $S/2 + K_2$

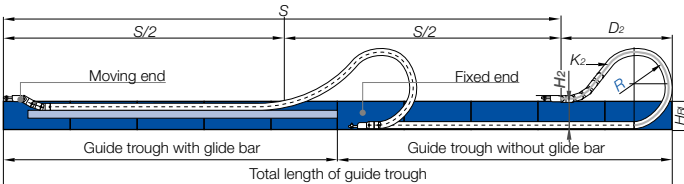

In case of travels between 4 and 10 m we recommend a longer unsupported length.



Gliding, long travel applications (max. 200 m)

In this case the E-Chain® upper run will be introduced in a guide trough on the lower run. We recommend to realize the engineering of such a plant by our technicians.

Technical Data

Speed / acceleration FL_G	max. 20 [m/s] / max. 200 [m/s²]
Speed / acceleration FL_B	max. 3 [m/s] / max. 6 [m/s²]
Gliding speed / acceleration (maximum)	max. 10 [m/s] / max. 50 [m/s²]
Material - permitted temperature °C	igumid G / -40° up to +120° C
Flammability class, igumid G	VDE 0304 IIC UL94 HB



Details of material properties

► page 1.38

System E4.1
Inner height: 28 mm

Phone +49- (0) 22 03-96 49-800
Fax +49- (0) 22 03-96 49-222



► page 7.15

igus® E-ChainSystems®

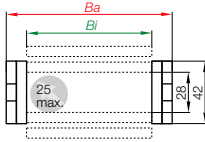

Part No. structure

E4.28.300.250.0



Series E4.28 - E-Chain® with crossbars every link

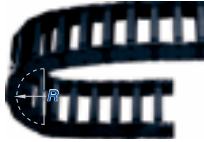

- Robust solution with crossbars every link
- Can be opened from two sides
- Removable crossbars



Phone+49- (0) 22 03-96 49-800
Fax +49- (0) 22 03-96 49-222

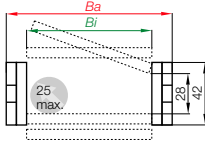

Part No. structure

R4.28.300.250.0



Series R4.28 - Fully enclosed E-Tube



- Fully enclosed
- Excellent cable protection against dirt
- Protection against hot chips
- Lids along the entire inner radius are completely removable. Lids along the entire outer radius are single sided snap-open with a hinge on the other side to keep them attached to the chain or completely removable.



igus® GmbH
51147 Cologne

Internet: www.igus.eu
E-mail: info@igus.de

Part No.	<i>Bi</i> [mm]	<i>Ba</i> [mm]	E4.28 [kg/m]	R4.28 [kg/m]
E4.28.040..... <input type="text"/> .0	40	60	≈ 1,06	-
E4.28/R4.28.050. <input type="text"/> .0	50	70	≈ 1,11	≈ 2,20
E4.28.062..... <input type="text"/> .0	62	82	≈ 1,17	-
E4.28.070..... <input type="text"/> .0	70	90	≈ 1,20	-
E4.28.075..... <input type="text"/> .0	75	95	≈ 1,23	-
E4.28.087..... <input type="text"/> .0	87	107	≈ 1,28	-
E4.28/R4.28.100. <input type="text"/> .0	100	120	≈ 1,37	≈ 2,54
E4.28/R4.28.125. <input type="text"/> .0	125	145	≈ 1,51	≈ 2,78
E4.28/R4.28.150. <input type="text"/> .0	150	170	≈ 1,61	≈ 3,02
E4.28/R4.28.175. <input type="text"/> .0	175	195	≈ 1,71	≈ 3,26
E4.28/R4.28.200. <input type="text"/> .0	200	220	≈ 1,84	≈ 3,50
E4.28/R4.28.225. <input type="text"/> .0	225	245	≈ 1,99	≈ 3,82
E4.28/R4.28.250. <input type="text"/> .0	250	270	≈ 2,14	≈ 3,98
E4.28.275..... <input type="text"/> .0	275	295	≈ 2,27	-
E4.28/R4.28.300. <input type="text"/> .0	300	320	≈ 2,39	≈ 4,46



Order-key for further options and versions for this series ► page 7.32

System E4.1
Inner height: 28 mm

*not available for R4.28

Available bending radii

R [mm]

Supplement Part No. with required radius. Example: E4.28.300..0

0 = standard color, other colors ► page 1.39 · Pitch: 46 mm/link - Links/m = 22

Phone +49- (0) 22 03-96 49-800
Fax +49- (0) 22 03-96 49-222

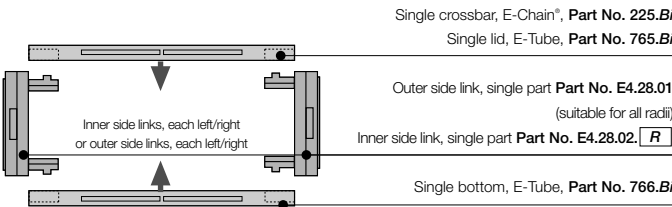

Part No. E-Chain®
links, single parts

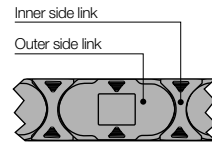

► page 7.15

igus® E-ChainSystems®



Vertical separators are used if a vertical subdivision is required. In the standard configuration, a separator is mounted at every second E-Chain® link. **Note:** Observe a lateral spacing of at least 20 mm (E-Tube)!

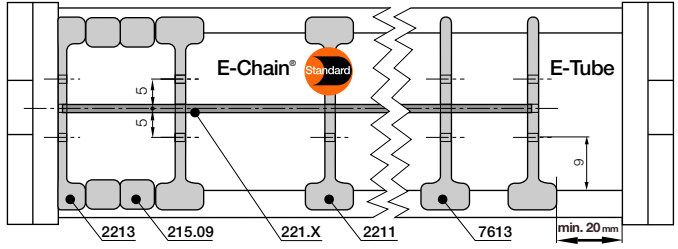

Phone+49- (0) 22 03-96 49-800
Fax +49- (0) 22 03-96 49-222



Vertical separator
2201



Vertical separator
7603



Spacer
205.09



Side plate
2203



Full-width shelf 220.X

Vertical separator for E-Chains®	2
unassembled	2201
assembled	2211

Vertical separator for E-Tubes	3
unassembled	7603
assembled	7613

Spacer* for E-Chains®	9
unassembled	205.09
assembled	215.09

Side plate for E-Chains®	3,5
unassembled	2203
assembled	2213

*For side-mounted applications

Option 1: Vertical separators and spacers

- **Standard separator 2201 for E-Chains®** is used when vertical and horizontal separation is required. Due to its slot, it allows basic vertical/horizontal shelving arrangements.
- **Vertical separator 7603 for E-Tubes R760.**
- Vertical separators in side-mounted applications, for instance, can be fixed in position by means of **spacer 205.09 for E-Chains®**. A wide range of intervals between the Vertical separators is adjustable here.
- **Note on spacers:** The available interior height is reduced by 2 mm per spacer (4 mm when spacers are fitted on both sides). To avoid this, the parts can also be installed from the outside on the opening crossbar.

Additionally:

- **Side plate 2203 and full-width shelf 220.X** - this option makes sense in applications with many thin cables with similar diameters. It is based upon **vertical separator 2201 (7603 for the Series R4.28 E-Tube)** is put in place and the shelf is inserted into the separator's slots. If no separators are desired, **side plate 2203** must be used with the **Series E4.28 E-Chain®**. This solution is not available for E-Tubes.

igus® GmbH
51147 Cologne

Internet: www.igus.eu
E-mail: info@igus.de

Full-width shelf

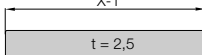

Width X [mm]	Part No. unassembled	Part No. assembled
040	220.40	221.40
050	220.50	221.50
062	220.62	221.62
070	220.70	221.70
075	220.75	221.75
087	220.87	221.87

Width X [mm]	Part No. unassembled	Part No. assembled
100	220.100	221.100
125	220.125	221.125
150	220.150	221.150
175	220.175	221.175
200	220.200	221.200

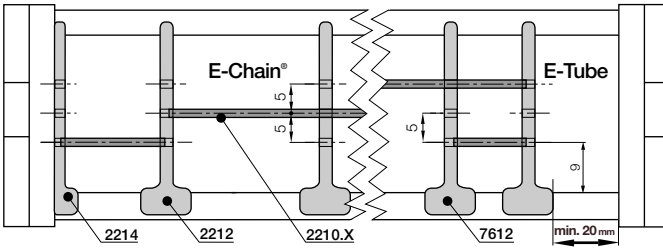

For use with many cables of differing diameters. E-Chains® and E-Tubes can be subdivided both vertically and horizontally. The shelves can be arranged elevator-shifted with different bottoms

Option 2: Shelves

● Side plates 2204, middle plates 2202 and Shelves 2200.X form the basic pattern of a shelf system. Shelves of various widths can be arranged at 3 different heights (in 5 mm increments).

● A middle plate 7602 is available for the E-Tube. Side plates are not available for the E-Tube.



Side plate for E-Chains®	
unassembled	2204
assembled	2214

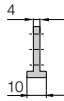

Middle plate for E-Chains®	
unassembled	2202
assembled	2212

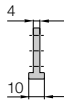

Middle plate for E-Tubes	
unassembled	7602
assembled	7612



Side plate 2204



Middle plate 2202



Middle plate 7602



Shelf 2200.X

Width X [mm]	Part No. unassembled	Part No. assembled
018	2200.18	2210.18
023	2200.23	2210.23
028	2200.28	2210.28
033	2200.33	2210.33
038	2200.38	2210.38
043	2200.43	2210.43
048	2200.48	2210.48

Width X [mm]	Part No. unassembled	Part No. assembled
058	2200.58	2210.58
068	2200.68	2210.68
073	2200.73	2210.73
088	2200.88	2210.088
099	2200.99	2210.099
124	2200.124	2210.124
149	2200.149	2210.149

Shelf

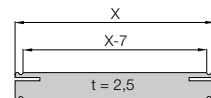

System E4.1
Inner height: 28 mm

Phone +49- (0) 22 03-96 49-800
Fax +49- (0) 22 03-96 49-222



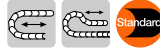

The Standard - Option KMA* - pivoting

- Recommended for unsupported and gliding applications
- Universal mountable with attachment capability on all sides
- Bolted connection outside of chain cross-section
- Confined installation conditions
- Corrosion resistant

*KMA = Polymer Metal Mounting Bracket

Moving end
E4.280/R4.280...□.2

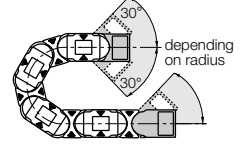

Fixed end

E4.280/R4.280...□.1

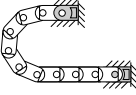

The attachment variants arising automatically by the choice of the KMA mounting bracket

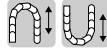

Option KMA - locking

- Recommended for vertical hanging / standing applications
- Additionally:
- Universal mountable
- Corrosion resistant
- Locked connections
- At very high acceleration

Moving end
E4.281/R4.281...□.2

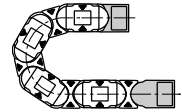

Fixed end

E4.281/R4.281...□.1

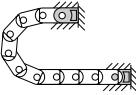

The attachment variants arising automatically by the choice of the KMA mounting bracket

Dimensions and order configurations

Part No. structure (pivoting)

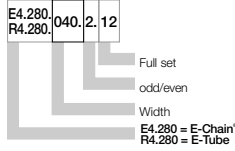

Part No. structure (locking)

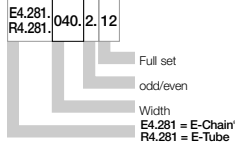

Fixed end
E4.280/R4.280...□.1 (pivoting)
E4.281/R4.281...□.1 (locking)

Moving end
(pivoting) E4.280/R4.280...□.2
(locking) E4.281/R4.281...□.2

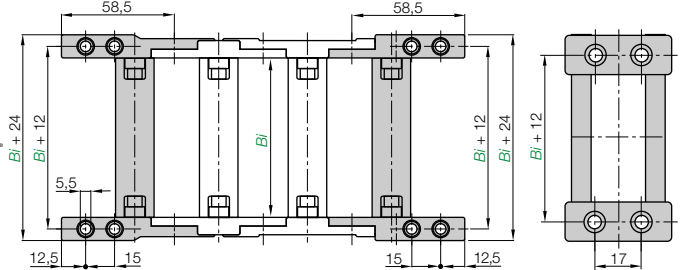

Width				Part No. full set				Bi	
index	pivoting	locking		index	pivoting	locking		index	Bi
.040.	E4.280	E4.281	.040.□.12	40	.150.	E4/R4.280	E4/R4.281	.150.□.12	150
.050.	E4/R4.280	E4/R4.281	.050.□.12	50	.175.	E4/R4.280	E4/R4.281	.175.□.12	175
.062.	E4.280	E4.281	.062.□.12	62	.200.	E4/R4.280	E4/R4.281	.200.□.12	200
.070.	E4.280	E4.281	.070.□.12	70	.225.	E4/R4.280	E4/R4.281	.225.□.12	225
.075.	E4.280	E4.281	.075.□.12	75	.250.	E4/R4.280	E4/R4.281	.250.□.12	250
.087.	E4.280	E4.281	.087.□.12	87	.275.	E4.280	E4.281	.275.□.12	275
.100.	E4/R4.280	E4/R4.281	.100.□.12	100	.300.	E4/R4.280	E4/R4.281	.300.□.12	300
.125.	E4/R4.280	E4/R4.281	.125.□.12	125					

Please insert 1 for odd number of links or 2 for even number of links

Note: The E4.1 System may end with either an inner side or an outer side link. Keep in mind that an outer side link always forms the first chain link at the moving end. The Part No. depend on an even or odd numbers of links. Please insert: 1 for odd number of links or 2 for even number of links

Full set, for both ends:

E4.280.040.2.12 (even)

Single-part order:

E4.280.040.2.2 (even)

Mounting bracket moving end

E4.280.040.2.1 (even)

Mounting bracket fixed end



E4.1 | Series E4.28 | Accessories | Strain Relief

Strain relief tie-wrap plate Part No. 2050.Z can be fixed on the last crossbar. **Details ▶ chapter 10**

Part No.	Width [mm]	Number of teeth
2050.Z	60	6

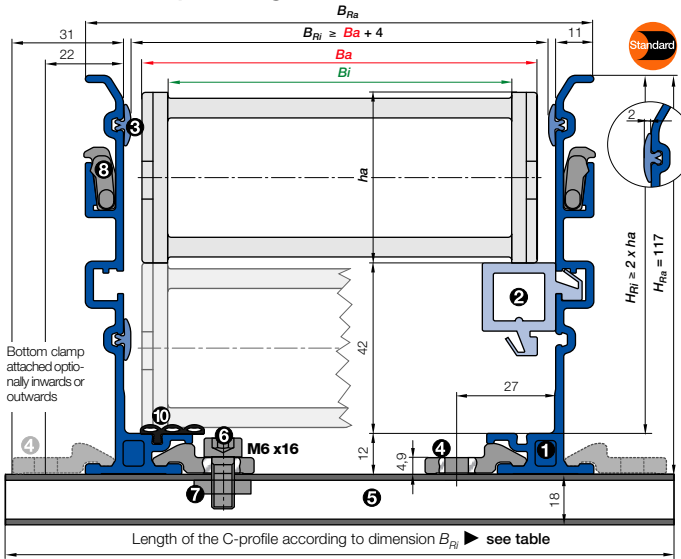

- B_a = Outer width E-Chains* / E-Tube
- B_i = Inner width E-Chains* / E-Tube
- h_a = Outer height E-Chains* / E-Tube
- H_{Ri} = Inner trough height
- H_{Ra} = Outer trough height
- B_{Ri} = Inner trough width ▶ depends on dim. B_a
- B_{Ra} = Outer trough width
- n_{Mon} = Number of installation sets (left/right)
- n_{Ri} = Number of trough sets (left/right)
- $H_{Ri} \approx 2 \cdot h_a$
- $B_{Ri} \approx B_a + 4$
- = Guide trough set ● = Guide bar
- = Installation set "Basic" ● = C-Profile

Installation set "Basic" with C-Profile

Bottom Clamp attached optionally inwards or outwards

E4.28.070.250.0 ▶ Order example

B_{Ri} [mm]	Order example	
	Part No. attached inwards	Part No. attached outwards
.040 64	-	960.30.175
.050 74	960.30.125	960.30.175
.062 86	960.30.150	960.30.200
.070 94	960.30.150	960.30.200
.075 99	960.30.150	960.30.200
.087 111	960.30.175	960.30.225
.100 124	960.30.175	960.30.225
.125 149	960.30.200	960.30.250
.150 174	960.30.225	960.30.275
.175 199	960.30.250	960.30.300
.200 224	960.30.275	960.30.325
.225 249	960.30.300	960.30.350
.250 274	960.30.325	960.30.375
.275 299	960.30.350	960.30.400
.300 324	960.30.375	960.30.425



- **Components, trough "Basic":** ① Trough side parts, aluminum, 2 m ② Glide bar, plastic, 2 m ③ Glide strips, plastic, 2 m (without glide strips on request) ⑩ Optional: Silencer profile, rubber
- **Components, installation set "Basic":** ④ Bottom clamp, aluminum ⑤ C-profile, steel galvanized ⑥ Screw M6 x 16 ⑦ Sliding nut M6 ⑧ Interface connector, plastic

Order example: Length of travel 30 m - Center mounted for Series E4.28.070.250.0 with $B_{Ri} = 94$

- Guide trough set (set of 2 trough side parts, incl. glide strips) **without** glide bar
Order text: 16 m guide trough without glide bar (8 x 2 m sections) Part No. 972.02.30.SL
- Guide trough set (set of 2 trough side parts, incl. glide strips) **with** glide bar
Order text: 16 m guide trough with glide bar (8 x 2 m sections) Part No. 972.02.31.SL
- Installation set "Basic" complete (guide trough-sets + 1)
Order text: 17 installation sets "Basic" Part No. 960.30.150
- Module for the fixed end
Order text: 1 set Part No. 972.82
- Option:** For an additional noise dampening with dampening profile, please add Index A Example:
Part No. 972.02.30.SLA

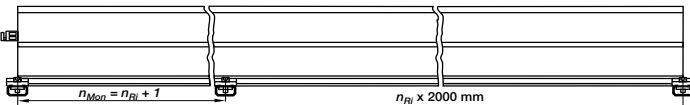

Principle sketch: Number of installation sets to be installed = **Number of trough sections + 1**



A quick fix for mounting the stationary end of an E-Chain®

With this module for the fixed end, fast and easy mounting onto the Aluminum "SuperTrough" is now possible without any drilling. Fast mounting of the E-Chain® by clamping onto the aluminum trough

- Quick relocation of the stationary end
- No drilling necessary ▶ [page 9.16](#)

Phone +49- (0) 22 03-96 49-800
 Fax +49- (0) 22 03-96 49-222

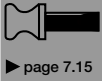
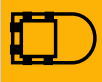

Standard

Part. No.
Standard
E-Chains®/E-Tubes



E4.28.050.R.0
(Crossbar every link)

R4.28.050.R.0
(E-Tube, closed)



Additional noise dampening with pads

Part. No.
Low noise (with pads)
E-Chains®/E-Tubes



ES4.28.050.R.0
(Crossbar every link)

RS4.28.050.R.0
(E-Tube, closed)

Easy turning of the outer link without rework

Part. No.
NC-Material
E-Chains®/E-Tubes

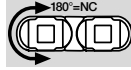

E4.28.050.R.0.NC
(Crossbar every link)

R4.28.050.R.0.NC
(E-Tube, closed)

Reverse bending radius for circular movements

Part. No.
RBR
E-Chains®/E-Tubes



E4.28.050.R1/R2.0
(Crossbar every link)

R4.28.050.R1/R2.0
(E-Tube, closed)

Unsupported lengths +25% possible

Part. No.
XXL-Material*
E-Chains®/E-Tubes

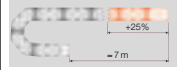

E4.28.050.R.0.XXL
(Crossbar every link)

R4.28.050.R.0.XXL
(E-Tube, closed)



Delivery time
24h or today

Delivery time
3-5 workdays

Delivery time
24h or today

Delivery time
3-5 workdays

Delivery time
1-2 weeks

*Sidebands made from XXL-Material

Order example - Standard

E4.28.	050.	200.	0
			Standard color black*
			Bending radius <i>R</i>
			Width
			Inner height
Series			

All E-Chains® made from igumid G are available in the colors listed in the table. Additional colors are usually feasible. (Standard color black). Colored E-Chains® are basically not available from stock.

Color options for igus® E-Chains® and E-Tubes. Standard color black (from stock)

E-Chains®/E-Tubes	igus® color index	Ral-numbers (approx.)	Delivery time
Material color			
black	Index .0	⇒ RAL 9004	from stock
white*	Index .1	⇒ RAL 9003	2-4 weeks
violet*	Index .5	⇒ RAL 4008	2-4 weeks
yellow*	Index .4	⇒ RAL 1018	2-4 weeks
orange*	Index .2	⇒ RAL 2003	2-4 weeks
red*	Index .6	⇒ RAL 3002	2-4 weeks
blue*	Index .8	⇒ RAL 5005	2-4 weeks
green*	Index .7	⇒ RAL 6011	2-4 weeks
grey*	Index .3 (E-Chains®)	⇒ RAL 7023	2-4 weeks
dusty grey*	Index .3 (E-Tubes)	⇒ RAL 7037	2-4 weeks
agate grey*	Index .11	⇒ RAL 7038	2-4 weeks
light grey*	Index .14	⇒ RAL 7035	2-4 weeks
black grey*	Index .13	⇒ RAL 7021	2-4 weeks
yellow/black*	Index .9	–	2-4 weeks

*Delivery Time and pricing for colored E-Chains® upon request

No burning-in of hot chips up to 850°C (1562° F)

ATEX/ESD classified E-Chains® - II 2 GD

Part. No.
HT-Material
only for E-Tubes

Part. No.
ESD-Material
E-Chains®/E-Tubes

R4.28.050.R.0.HT
Complete E-Tube*

E4.28.050.R.0.ESD
(Crossbar every link)

R4.28.050.HT.R.0
Lid and bottom

R4.28.050.R.0.ESD
(E-Tube, closed)

R4.28.050.HTZ.R.0
Bottom only

R4.28.050.HTE.R.0
Lid only

Delivery time up to 4 weeks

Delivery time up to 2 weeks

*for gliding applications please consult igus®

Combination possibilities, examples:

	Low noise Option	NC-Version	RBR-Version	XXL-Material	HT-Material*	ESD-Material
Low noise Option		ES4.28.050.R.0.NC	-	ES4.28.050.R.0.XXL	RS4.28.050.R.0.HT	ES4.28.050.R.0.ESD
NC-Version	ES4.28.050.R.0.NC		-	-	R4.28.050.R.0.HTNC	E4.28.050.R.0.ESD.NC
RBR-Version	-	-		-	R4.28.050.R1/R2.0.HT	E4.28.050.R1/R2.0.ESD
XXL-Material	ES4.28.050.R.0.XXL	-	-		-	-
HT-Material*	RS4.28.050.R.0.HT	R4.28.050.R.0.HTNC	R4.28.050.R1/R2.0.HT	-		-
ESD-Material	ES4.28.050.R.0.ESD	E4.28.050.R.0.ESD.NC	E4.28.050.R1/R2.0.ESD	-	-	

*for gliding applications please consult igus®

Price index



Series E4.32 Series H4.32 Series R4.32



Low noise version
available with special
rubber pads design



Cleanroom test
upon request



ESD classification:
Electrically conductive ESD/ATEX
version upon request



Opening E-Chains: Remove crossbars and
clips - Insert screwdriver into the slot, push
down, release by lever action



Remove lids/bottoms (E-Tubes) - Insert screw-
driver into the slot, release by lever action



When to use the Series E4.32/H4.32/R4.32:

- If a low-noise version is required
- At very high speeds and/or accelerations
- For long travels
- For high additional loads



When not to use it:

- When an extremely low vibration
E-Chain® is required
- ▶ Series E6.35, page 8.50
- When a one-sided snap open E-Chain®/
E-Tube is required for economic reasons
- ▶ Series 2600/2650/2680/2700, page 5.114

- 1 Straight run through inner-/outer-link design
- 2 Low-noise operation through integrated brake in the radial stop dog system
- 3 By the undercut design, very high stiffening and carrying capacity when shear forces are at work
- 4 15% more tensile strength (compared to the best old E4 series), better unsupported length through improved stop dog system and vertical radial stops
- 5 Crossbar available for faster assembly/disassembly - 385.X.Q
- 6 New Interior separation kit available
- 7 Version NC "without pretension" simply by turning outer links without rework possible
- 8 Crossbars are removable along both radii
- 9 Hinged snap-open removable lids - E-Tube
- 10 Wide, rounded plastic crossbars - cable friendly
- 11 Optimized glide pads - long service life
- 12 Smooth outline, dirt repellent
- 13 Strain relief with strain relief separators in the mounting bracket are available



Order example complete E-Chain®

Please indicate chain-lengths or number of links Example: 4 m or 72 links

4 m E4.32.30.300.0

E-Chain®

with 2 separators 282 assembled every 2nd link

Interior separation

1 set E4.320.30.1.12.C

Mounting bracket



Unsupported length

FL_G = with straight upper run

FL_B = with permitted sag

Further information ► **Design, page 1.12**

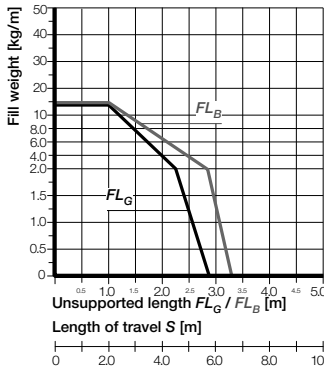
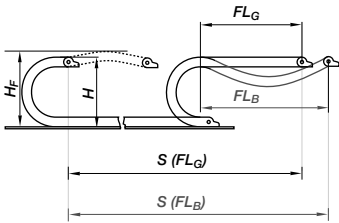

- S = Length of travel
- R = Bending radius
- H = Nominal clearance height
- H_F = Required clearance height
- H_{Ri} = Trough inner height
- D = Overlength E-Chain® radius in final position
- $K = \pi \cdot R + \text{"safety"}$
- D_2 = Over length - long travels, gliding
- K_2 = *Further add-on
- H_2 = *Mounting height

*If the mounting bracket location is set lower

Other installation methods

- Vertical, hanging ≤ 80 m
- Vertical, standing ≤ 5 m
- Side mounted, un supp. $\leq 1,5$ m
- Rotary requires further calculation
- Unsupported length of upper run = upon request

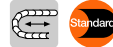

Short travels - unsupported

Unsupported E-Chains® feature positive camber over short travels. This must be accounted for when specifying the clearance height H_F . Please consult igus® if space is particularly restricted.

The required clearance height:
 $H_F = H + 40$ mm
(with 2,0 kg/m fill weight)

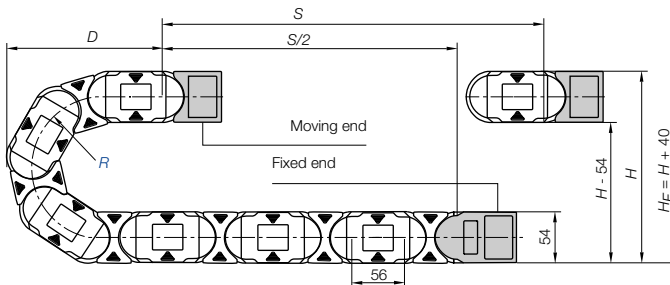

Pitch = 56 mm/link Links/m = 18 (1008 mm) Chain length = $S/2 + K$

R	063	075	100	125	150	175	200	220	250	300
H_{+20}	180	204	254	304	354	404	454	494	554	654
D	146	158	183	208	233	258	283	303	333	383
K	310	350	430	505	585	665	745	805	900	1055
H_2	180	204	166	166	166	166	166	166	166	166
D_{+25}	146	158	370	470	500	655	770	900	930	1100
K_2	310	350	616	784	896	1120	1288	1456	1568	1904

Long travel lengths from 10 m to max. 200 m Chain length = $S/2 + K_2$

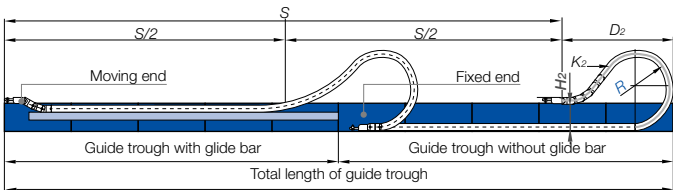

In case of travels between 4 and 10 m we recommend a longer unsupported length.



Gliding, long travel applications (max. 200 m)

In this case the E-Chain® upper run will be introduced in a guide trough on the lower run. We recommend to realize the engineering of such a plant by our technicians.

Technical Data

Speed / acceleration FL_G	max. 20 [m/s] / max. 200 [m/s]
Speed / acceleration FL_B	max. 3 [m/s] / max. 6 [m/s]
Gliding speed / acceleration (maximum)	max. 10 [m/s] / max. 50 [m/s]
Material - permitted temperature °C	igumid G / -40° up to +120° C
Flammability class, igumid G	VDE 0304 IIC UL94 HB



Details of material properties
► page 1.38

For support of the lower run - **Support Tray tool kit** available ► page 9.70

32

System E4.1
Inner height: 32 mm

Phone +49- (0) 22 03-96 49-800
Fax +49- (0) 22 03-96 49-222

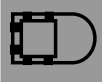

► page 7.15

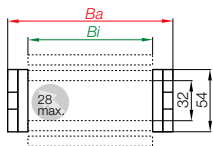

Part No. structure

E4.32. 30. 300. 0



Series E4.32 - E-Chain® with crossbars every link

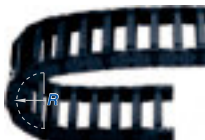

- Crossbars every link
- For rigid hydraulic hoses
- For applications particularly demanding
- Can be opened from two sides

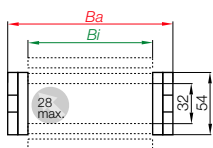

Part No. structure

H4.32. 20. 300. 0



Series H4.32 - E-Chain® with crossbars every 2nd link



- Crossbars every 2nd link = Standard
- For nearly every situation
- Can be opened from two sides
- Easy assembly
- Stable
- Attractive price

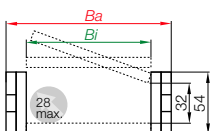

Part No. structure

R4.32. 30. 300. 0



Series R4.32 - Fully enclosed E-Tube



- Fully enclosed
- Excellent cable protection against dirt
- Protection against hot chips
- Lids along the entire inner radius are completely removable. Lids along the entire outer radius are single sided snap-open with a hinge on the other side to keep them attached to the chain or completely removable.



Part No.	<i>Bi</i> [mm]	<i>Ba</i> [mm]	E4.32 [kg/m]	H4.32 [kg/m]	R4.32 [kg/m]
E4.32/H4.32/R4.32.05.	50	73	1,567	1,425	2,450
E4.32/H4.32.06.	68	91	1,697	1,490	-
E4.32/H4.32/R4.32.07.	75	98	1,730	1,507	2,570
E4.32/H4.32.087.	87	110	1,803	1,543	-
E4.32/H4.32/R4.32.10.	100	123	1,886	1,584	2,650
E4.32/H4.32/R4.32.11.	108	131	1,942	1,612	2,760
E4.32/H4.32.112.	112	136	1,956	1,619	-
E4.32/H4.32/R4.32.12.	125	148	2,069	1,676	2,850
E4.32/H4.32.137.	137	161	2,122	1,702	-
E4.32/H4.32/R4.32.15.	150	173	2,212	1,747	3,010
E4.32/H4.32.162.	162	186	2,240	1,762	-
E4.32/H4.32/R4.32.17.	168	191	2,323	1,803	3,210
E4.32/H4.32.18.	175	198	2,345	1,814	-
E4.32/H4.32.187.	187	211	2,392	1,837	-
E4.32/H4.32/R4.32.20.	200	223	2,518	1,900	3,410
E4.32/H4.32.212.	212	236	2,568	1,925	-
E4.32/H4.32.23.	225	248	2,669	1,976	-
E4.32/H4.32.237.	237	261	2,698	1,990	-
E4.32/H4.32/R4.32.25.	250	273	2,834	2,059	3,860
E4.32/H4.32.262.	262	286	2,917	2,100	-
E4.32/H4.32.28.	275	298	2,989	2,136	-
E4.32/H4.32.29.	287	311	3,023	2,153	-
E4.32/H4.32/R4.32.30.	300	323	3,151	2,217	4,250
E4.32/H4.32.312.	312	336	3,175	2,229	-
E4.32/H4.32.325.	325	348	3,277	2,280	-
E4.32/H4.32.337.	337	361	3,338	2,311	-
E4.32/H4.32.350.	350	373	3,565	2,424	-
E4.32/H4.32.362.	362	386	3,662	2,473	-
E4.32/H4.32.375.	375	398	3,735	2,509	-
E4.32/H4.32.387.	387	411	3,803	2,543	-
E4.32/H4.32.400.	400	423	3,868	2,575	-



Order-key for further options and versions for this series ► page 7.46

System E4.1
Inner height: 32 mm

Phone +49- (0) 22 03-96 49-800
Fax +49- (0) 22 03-96 49-222

*Removable lid only, no hinged option · **not available for R4.32

Available bending radii

R [mm] **063*** **075*** **100*** 125 150 175 200 220 250 300

Supplement Part No. with required radius. Example: E4.32.30.**300**.0

0 = standard color, other colors ► page 1.39 · Pitch: 56 mm/link - Links/m = 18



Extender crossbar for large diameter hoses ► page 7.42



► page 7.15

Single crossbar, E-Chain®, Part No. 385.Bi

Single lid, E-Tube, Part No. 775.Bi

Outer side link, single part Part No. E4.32.01
(suitable for all radii)

Inner side link, single part Part No. E4.32.02. *R*

Single bottom, E-Tube, Part No. 776.Bi

Part No. E-Chain®
links, single parts

Inner side link

Outer side link

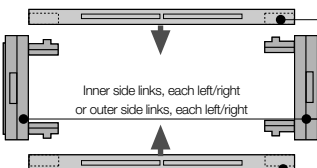

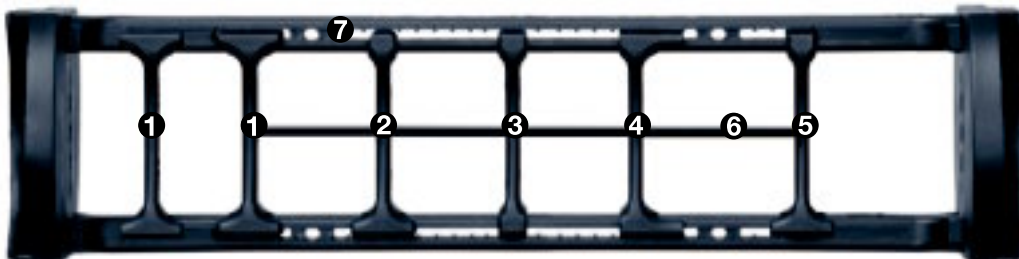

Optimized and extended interior separation range for Series E4.32. Wear optimized geometry with a high locking strength. The very cable friendly design increases your cables cycle life even further. Universally suitable for E-Chains® and E-Tubes, 1x slotted!

Phone +49- (0) 22 03-96 49-800
Fax +49- (0) 22 03-96 49-222



- ① Standard Separator, wide foot - Part. No. 32.1
- ② Separator for QuickLock crossbar - Part. No. 32.2
- ③ Narrow separator - Part. No. 32.3
- ④ Asymmetric separator - Part. No. 32.4
- ⑤ Notch separator - Part. No. 32.5

Realize a better separation with fewer, standardized parts

- Optimized and extended interior separation range
- The very cable friendly design increases your cables cycle life even further
- Same separation for E-Chains® and E-Tubes
- Safe force closure connection
- Cable friendly plastic crossbars, optimized for low cable wear and long cycle life
- Faster and easier assembly

igus® GmbH
51147 Cologne



⑥ Functionality - full-width shelf, lockable - Part. No. 3200.XX

⑥ For horizontal separation: Full-width shelf

- Shelf locks safely into separators on both ends through special locking clip
- Separators can be moved freely over the shelf in horizontal direction
- No side plates necessary
- Partial horizontal shelving possible



⑦ Standard* for all E4 crossbars and lids/bottoms: lock-in and scaling

*First few sizes available. Completion of the product range by the end of 2009

⑦ Notch crossbars, notch bottoms and lids

- No additional spacers necessary for side-mounted applications
- High locking strength of the separator in lock-in position
- Clearly visible, plane scaling
- Clearly notches and scaling on crossbars for E-Chains® and bottoms and lids of E-Tubes

Internet: www.igus.eu
E-mail: info@igus.de

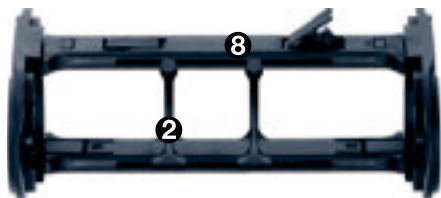

⑧ QuickLock crossbar, single part - Part No. 385.X.Q
(X = Inner width Bi E-Chains® / Q = QuickLock)

⑧ Optimized QuickLock crossbar

- One-click opening of the QuickLock crossbar = 25 % faster assembly compared to standard crossbars
 - Quick assembly/disassembly
 - Faster assembly with less effort
 - Free access to the top, E-Chain® can remain in the guide trough
- www.igus.de/en/E4schnelleMontage

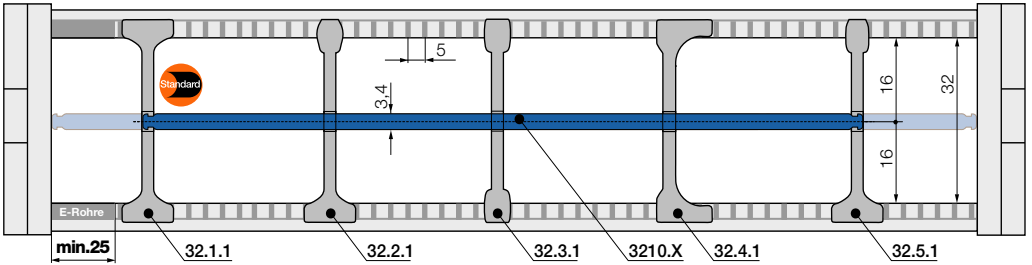

In the standard configuration, a separator is mounted at every second chain link!

Note: Observe a lateral spacing of at least 25 mm (E-Tube)!

Standard - for all applications

① Separator with wide foot for maximum locking strength and safe standing in E-Chains® and E-Tubes

For even faster installation

② Separator for igus® ③ QuickLock crossbar 385.X.Q. Firm hold to one side with a wide foot, narrow on opposed side for easy cable assembly (slight grip)

For many thin cables

④ Separator with narrow feet for a large number of thin cables side by side. Saves space in E-Chains® and E-Tubes.

Fore side-mounted applications

⑤ Asymmetrical separator, for defined distance. No additional spacers necessary for E-Chains® and E-Tubes

Locks safely onto in 5 mm increments

⑥ Notch separator for ⑦ the new notch crossbar. With scaling on the notch crossbars. For exact positioning in E-Chains® and E-Tubes

Horizontal separation

⑧ Full-width shelf (Inner widths 50 - 250 mm). Shelf locks safely into separators on both ends, fixed width possible. Separators can be moved freely over the shelf in horizontal direction. Usable in 1 level.

 3 12		Standard separator, wide foot unassembled 32.1 assembled 32.1.1	
 7 3 12		Separator for QuickLock crossbar unassembled 32.2 assembled 32.2.1	
 3 8		Separator, narrow foot unassembled 32.3 assembled 32.3.1	
 3 2.75 0.25 12		Asymmetrical separator unassembled 32.4 assembled 32.4.1	
 7 3 12		Notch separator unassembled 32.5 assembled 32.5.1	
 X-1		Full-width shelf, lockable unassembled 3200.X assembled 3210.X XX = Width - see table below!	50 - 250 mm

Phone +49- (0) 22 03-96 49-800
Fax +49- (0) 22 03-96 49-222



▶ page 7.15

Width	Part No.	Part No.	Width	Part No.	Part No.
X [mm]	unassembled	assembled	X [mm]	unassembled	assembled
050	3200.050	3210.050	150	3200.150	3210.150
075	3200.075	3210.075	175	3200.175	3210.175
100	3200.100	3210.100	200	3200.200	3210.200
115	3200.115	3210.115	225	3200.225	3210.225
125	3200.125	3210.125	250	3200.250	3210.250



Interior separation configurator online ▶ www.igus.eu/iaconfigurator



Standard 02 - Proven and tested interior separation elements for special and extremely variable partitioning! For use with many cables of differing diameters. E-Chains® and E-Tubes can be subdivided both vertically and horizontally.

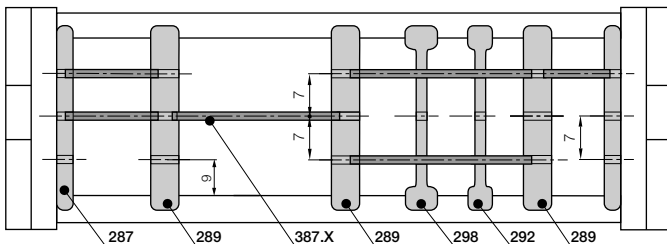

Split separator T323, to be split for shelf 386.X



Side plate 286



Middle plate 288



Slotted separator 291



Open slotted separator 297



Shelf 386.X

Split separator for E-Chains®

unassembled	T323
assembled	T323M



Side plate for E-Chains®/E-Tubes

unassembled	286
assembled	287



Middle plate for E-Chains®/E-Tubes

unassembled	288
assembled	289



Slotted separator for E-Chains®

unassembled	291
assembled	292



Open slotted separator for E-Chains®/E-Tubes

unassembled	297
assembled	298



More proven interior separation elements

● **Split separator T323** - ideal for subsequent shelving or for the initial assembly of the E-Chain®. Fast assembly and disassembly possible through hinge/push mechanism. Saves assembly time. Enhances flexibility. (For Shelf 386.X).

● **Side plates 286, middle plates 288 und Shelves 386.X** form the basic pattern of a shelf system. Shelves of various widths can be arranged at 3 different heights (in 7 mm increments).

● For special applications: **Vertical separator with injection moulded shelf 281.S.57** (57,5 mm) or **281.S.45** (45 mm).

● **Slotted separators 291** (not for E-Tubes), are used for very fine subdivisions. However, they cannot be retrofitted into an existing separation system without dismantling the interior separators first.

● The unilateral **open, slotted separator 297** can be retrofitted into an existing interior separation system without a need for dismantling the interior separators. During an installation of open slotted separators, the top and bottom notches cannot be occupied by shelves.

Width X [mm]	Part No.	
	unassembled	assembled
018	386.18	387.18
023	386.23	387.23
025	386.25	387.25
028	386.28	387.28
033	386.33	387.33
043	386.43	387.43
050	386.50	387.50
054	386.54	387.54
062	386.62	387.62
075	386.75	387.75

Width X [mm]	Part No.	
	unassembled	assembled
087	386.87	387.87
100	386.100	387.100
108	386.108	387.108
125	386.125	387.125
150	386.150	387.150
175	386.175	387.175
200	386.200	387.200
208	386.208	387.208
225	386.225	387.225

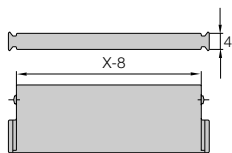

For new constructions, we recommend the new igus® interior separation kit
Previous interior separation - will continue to be available!

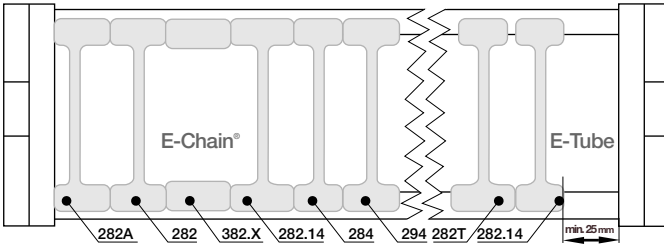

Vertical separators are used if a vertical subdivision is required. In the standard configuration, a separator is mounted at every second E-Chain® link. **Note:** Observe a lateral spacing of at least 25 mm (E-Tube)!

Vertical separators and spacers

● **Standard separator 281 for E-Chains®** offers safe stability due to its broad foot design, also when used with thick cables or hoses. If the distance needed between separators is greater than this separator's dimension, we offer the **Vertical separator 281.14**.

● **Standard separator 281 for E-Chains®** offers safe stability due to its broad foot design, also when used with thick cables or hoses. If the distance needed between separators is greater than this separator's dimension, we offer the **Vertical separator 281.14**.

● **Vertical separator 283 with a narrow foot for E-Chains®** with applications where a large number of small cables need to be individually separated.

● Separators (e.g. "side mounted") for E-Chains® can be fixed in their position with **spacers 381.XX**. The available inner height will be reduced by 2 mm, per spacer and side. To avoid this, the parts can be assembled on outside of the crossbar (not for long travels) **XX = width of the spacer** (available 10, 15 and 20).

● **Locking separator 293 for E-Chains®** - with increased retention force for applications exposed to very high humidity or extreme loads. The extra retention force is achieved by asymmetric claws for the crossbar. Ensure proper alignment (not for E-Tubes).

● **Asymmetric separator 281A for E-Chains®** (not for E-Tubes) with an 12-mm base, for combinations between spacers of different widths and vertical separators in side-mounted applications, for instance.



Vertical separator for E-Chains®	
unassembled	281
assembled	282

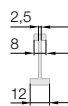

Vertical separator for E-Tubes	
unassembled	281T
assembled	282T

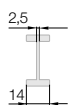

Vertical separator for E-Chains®/E-Tubes	
unassembled	281.14
assembled	282.14

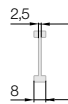

Vertical separator for E-Chains®	
unassembled	283
assembled	284



Spacer* for E-Chains®	
unassembled	381.XX
assembled	382.XX

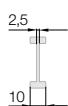

Locking separator for E-Chains®	
unassembled	293
assembled	294

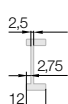

Asymmetric separator for E-Chains®	
unassembled	281A
assembled	282A

*For side-mounted applications

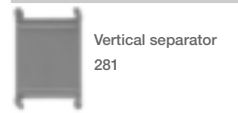

Vertical separator 281

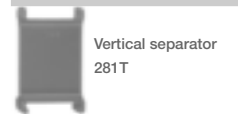

Vertical separator 281T

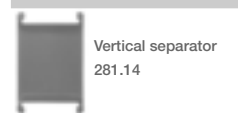

Vertical separator 281.14

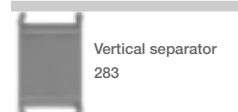

Vertical separator 283

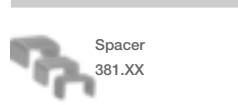

Spacer 381.XX

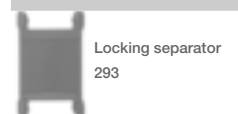

Locking separator 293

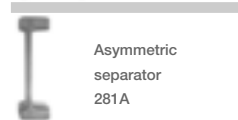

Asymmetric separator 281A

System E4.1
Inner height: 32 mm

Phone +49- (0) 22 03-96 49-800
Fax +49- (0) 22 03-96 49-222





Extension links - for extremely wide E-Chains® up to 3 m

- For applications in which particularly high fill weights necessitate extremely wide E-Chains® (up to 3000 mm)
- The extension link design allows virtually limitless side-by-side attachment of chains
- The unsupported length of a chain can be increased when additional loads are required
- Extension links can be used with E-Chains®, E-Tubes or as a combination of both
- They are suitable for unsupported and gliding applications in a guide trough
- E-Chains® with extension links are attached with KMA or steel mounting brackets



Part No. structure

E4.32.10 /20 /10. 200.0

E4.32.Bi1/Bi2/Bi3. R.0

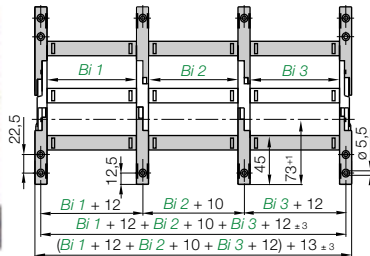
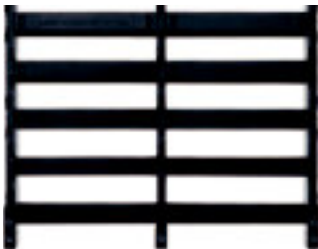

Extender crossbars - careful guide of hoses applications

- Suitable for hoses with a maximum outer diameter of 105 mm
- Gliding operation with crossbars assembled along the outer radius and a special guide trough
- Gliding operation not guaranteed with crossbars assembled along the inner radius
- The extender crossbar can either be attached to the side links directly or can be used in combination with two stranded snap-open crossbars

Consult igus® for your extender crossbar applications. We are happy to assist you with your design layout

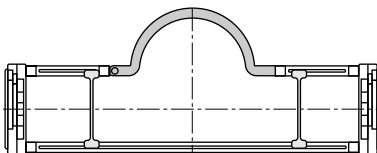

385.15RHD115 round extender crossbar combined with snap-open crossbars

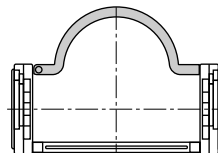

385.18RD115 round strap attached directly on the side link

Part No.	Max Ø [mm] hose	Form	Installation side link	Combination with snap-open crossb.
385.15.RHD115	105	○	-	+
385.18.RD115	105	○	+	-

○ = round + = yes / - = no



Hinged crossbars

- Typically E-Chain® crossbars are completely removable. For cases where the snap-open crossbars have to remain at the open link of the E-Chain®, a hinged design has been developed
- Length: 37,5 mm **Part No. 385.02** / snap-open crossbar (shortened): Bi-37,5 mm **Part No. 385.03**
- Please consult igus® for design assistance

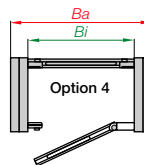
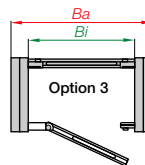
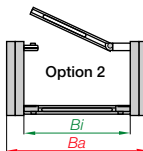
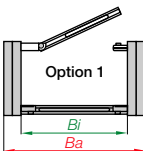
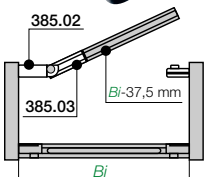

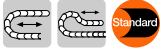

The Standard - Option KMA* - pivoting

- Recommended for unsupported and gliding applications
- Universal mountable with attachment capability on all sides
- Bolted connection outside of chain cross-section
- Confined installation conditions
- Corrosion resistant

*KMA = Polymer Metal Mounting Bracket

Moving end

E4.320/R4.320...□.2

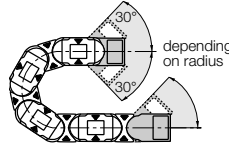

Fixed end

E4.320/R4.320...□.1



The attachment variants arising automatically by the choice of the KMA mounting bracket

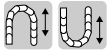
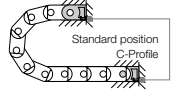

Option KMA - locking

- Recommended for vertical hanging / standing applications

Additionally:

- Universal mountable
- C-profile option
- Corrosion resistant
- Locked connections
- At very high acceleration

Moving end

E4.321/R4.321...□.2

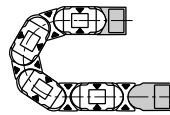

Fixed end

E4.321/R4.321...□.1



The attachment variants arising automatically by the choice of the KMA mounting bracket

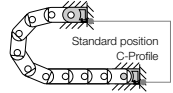

Fixed end

E4.320/R4.320...□.1 (pivoting)

E4.321/R4.321...□.1 (locking)

Moving end

(pivoting) E4.320/R4.320...□.2

(locking) E4.321/R4.321...□.2

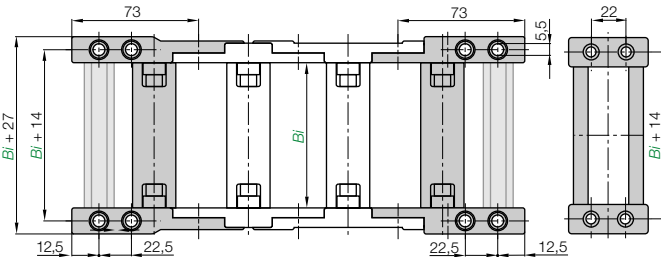

Width index	Part No. pivoting	Part No. locking	Bi (mm)	Width index	Part No. pivoting	Part No. locking	Bi (mm)
.05	E4/R4.320	E4/R4.321	.05 □.12 □ 50	.23	E4.320	E4.321	.23 □.12 □ 225
.06	E4.320	E4.321	.06 □.12 □ 68	.237	E4.320	E4.321	.237 □.12 □ 237
.07	E4/R4.320	E4/R4.321	.07 □.12 □ 75	.25	E4/R4.320	E4/R4.321	.25 □.12 □ 250
.087	E4.320	E4.321	.087 □.12 □ 87	.262	E4.320	E4.321	.262 □.12 □ 262
.10	E4/R4.320	E4/R4.321	.10 □.12 □ 100	.28	E4.320	E4.321	.28 □.12 □ 275
.11	E4/R4.320	E4/R4.321	.11 □.12 □ 108	.29	E4.320	E4.321	.29 □.12 □ 287
.112	E4.320	E4.321	.112 □.12 □ 112	.30	E4/R4.320	E4/R4.321	.30 □.12 □ 300
.12	E4/R4.320	E4/R4.321	.12 □.12 □ 125	.312	E4.320	E4.321	.312 □.12 □ 312
.137	E4.320	E4.321	.137 □.12 □ 137	.325	E4.320	E4.321	.325 □.12 □ 325
.15	E4/R4.320	E4/R4.321	.15 □.12 □ 150	.337	E4.320	E4.321	.337 □.12 □ 337
.162	E4.320	E4.321	.162 □.12 □ 162	.350	E4.320	E4.321	.350 □.12 □ 350
.17	E4/R4.320	E4/R4.321	.17 □.12 □ 168	.362	E4.320	E4.321	.362 □.12 □ 362
.18	E4.320	E4.321	.18 □.12 □ 175	.375	E4.320	E4.321	.375 □.12 □ 375
.187	E4.320	E4.321	.187 □.12 □ 187	.387	E4.320	E4.321	.387 □.12 □ 387
.20	E4/R4.320	E4/R4.321	.20 □.12 □ 200	.400	E4.320	E4.321	.400 □.12 □ 400
.212	E4.320	E4.321	.212 □.12 □ 212				

Please insert 1 for odd number of links or 2 for even number of links

Dimensions and order configurations

Part No. structure (pivoting)

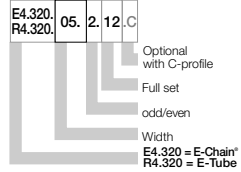

Part No. structure (locking)

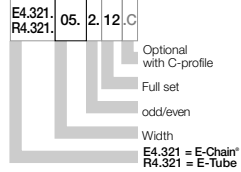

Note: The E4.1 System may end with either an inner side or an outer side link. Keep in mind that an outer side link always forms the first chain link at the moving end. The Part No. depend on an even or odd numbers of links. Please insert: 1 for odd number of links or 2 for even number of links

Full set, for both ends:

E4.320. 05. 2. 1. 2. 1. 2. C (even)

Single-part order:

E4.320. 05. 2. 1. 2. C (even)

Mounting bracket moving end

E4.320. 05. 2. 1. 1. C (even)

Mounting bracket fixed end

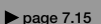



Chainfix steel clamps and Chainfix stainless-steel clamps - max. pull forces, adjustable with hexagon socket. Available as single, double or triple clamps

Chainfix clamps for the C-profile

Part No. single clamps		Part No. double clamps		Part No. triple clamps		Cable
steel	stainless steel	steel	stainless steel	steel	stainless steel	ø [mm]
CFX12.1	CFX12.1.E	CFX12.2	CFX12.2.E	CFX12.3	-	06 - 12
CFX14.1	CFX14.1.E	CFX14.2	CFX14.2.E	CFX14.3	-	12 - 14
CFX16.1	CFX16.1.E	CFX16.2	CFX16.2.E	CFX16.3	-	14 - 16
CFX18.1	CFX18.1.E	CFX18.2	CFX18.2.E	CFX18.3	-	16 - 18
CFX20.1	CFX20.1.E	CFX20.2	CFX20.2.E	CFX20.3	-	18 - 20
CFX22.1	CFX22.1.E	CFX22.2	CFX22.2.E	CFX22.3	-	20 - 22
CFX26.1	CFX26.1.E	CFX26.2	CFX26.2.E	-	-	22 - 26
CFX30.1	CFX30.1.E	CFX30.2	CFX30.2.E	-	-	26 - 30
CFX34.1	CFX34.1.E	CFX34.2	CFX34.2.E	-	-	30 - 34
CFX38.1	CFX38.1.E	-	-	-	-	34 - 38
CFX42.1	CFX42.1.E	-	-	-	-	38 - 42



Chainfix Clip - Modular snap-on strain relief device for C-profile

Available for all igus® E-ChainSystems® with C-profiles and also suitable for assembly in the KMA mounting brackets and Clip-on strain relief for crossbars. High pull forces, plug-in modular snap-on strain relief device. **Details ▶ chapter 10**

Cable ø [mm]	Part No. clamp	Part No. bottom part
04 - 08	CFC-08-M	CFC-08-C
08 - 12	CFC-12-M	CFC-12-C
12 - 16	CFC-16-M	CFC-16-C
16 - 20	CFC-20-M	CFC-20-C
20 - 24	CFC-24-M	CFC-24-C



Chainfix Nugget for the C-Profile

Strain relief for the fixation of cables up to a diameter of Ø 30 mm. Easy to assemble, without any screws and tools. Easy strain relief due to fixation with pre-harnessed cable strap, very small space requirement. **Details ▶ chapter 10**

Part No.	ø max. conduit [mm]	Width [mm]
CFN.20	20	10,8
CFN.30.52	30	16,8
CFN.20.N35	20	20,0

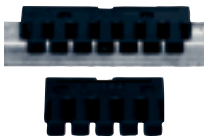

Chainfix tiwrap plates with clip-on connection for the C-profile

Can be plugged into the KMA C-profile. Easy to assemble without any screws. Easily solvable with screwdriver nevertheless safe stop. For all E-Chains® with KMA and integrated C-profile. **Details ▶ chapter 10**

Part No.	Width of strain relief [mm]	Number of teeth
3050.ZC	50	5
3075.ZC	75	7



Chainfix tiwrap plate as individual part

As individual component screwed on KMA, can also be plugged into the mounting bracket. **Details ▶ chapter 10**

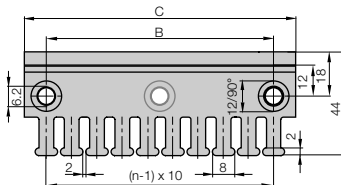
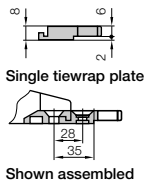

Tiwrap plate	No. of teeth n	Dim. C [mm]	Dim. B [mm]	Center bore
3050.ZB	5	50	30	-
3075.ZB	7	75	55	-
3100.ZB	10	100	80	-
3115.ZB	11	115	95	-
3125.ZB	12	125	105	-
3150.ZB	15	150	130	-
3175.ZB	17	175	155	-
3200.ZB	20	200	180	+
3225.ZB	22	225	205	+
3250.ZB	25	250	230	+

(- = no / + = yes)

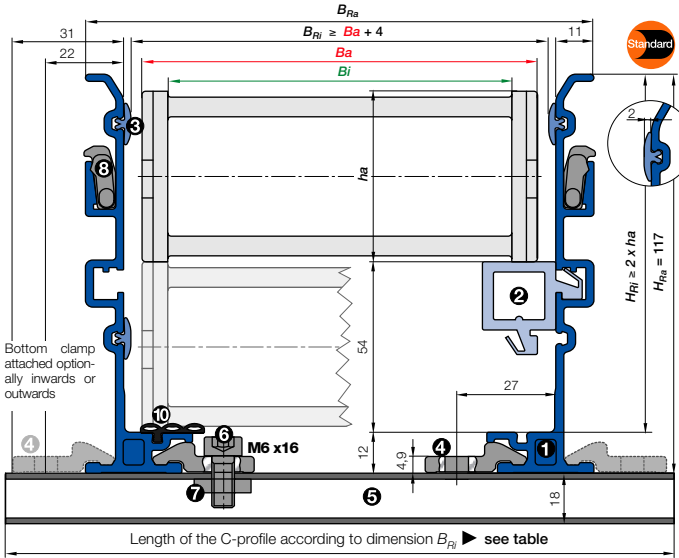

- B_a = Outer width E-Chains* / E-Tube
- B_i = Inner width E-Chains* / E-Tube
- h_a = Outer height E-Chains* / E-Tube
- H_{Ri} = Inner trough height
- H_{Ra} = Outer trough height
- B_{Ri} = Inner trough width ▶ depends on dim. B_a
- B_{Ra} = Outer trough width
- n_{Mon} = Number of installation sets (left/right)
- n_{Ri} = Number of trough sets (left/right)
- $H_{Ri} \geq 2 \times h_a$
- $B_{Ri} \geq B_a + 4$
- = Guide trough set ● = Glide bar
- = Installation set "Basic" ● = C-Profile

Installation set "Basic" with C-Profile

Bottom Clamp attached optionally inwards or outwards

E4.32.05.200.0 ▶ Order example

B_{Ri} [mm]	Order example	
	Part No. attached inwards	Part No. attached outwards
.05	77 960.30.125	960.30.175
.06	95 960.30.150	960.30.200
.07	102 960.30.150	960.30.200
.08	114 960.30.175	960.30.225
.10	127 960.30.175	960.30.225
.11	135 960.30.200	960.30.250
.112	140 960.30.200	960.30.250
.12	152 960.30.200	960.30.250
.13	165 960.30.225	960.30.275
.15	177 960.30.225	960.30.275
.162	190 960.30.250	960.30.300
.17	195 960.30.250	960.30.300
.18	202 960.30.250	960.30.300
.187	215 960.30.275	960.30.325
.20	227 960.30.275	960.30.325
.212	240 960.30.300	960.30.350
.23	252 960.30.300	960.30.350
.237	265 960.30.325	960.30.375
.25	277 960.30.325	960.30.375
.262	290 960.30.350	960.30.400
.28	302 960.30.350	960.30.400
.29	315 960.30.375	960.30.425
.30	327 960.30.375	960.30.425
.312	340 960.30.400	960.30.450
.325	352 960.30.400	960.30.450
.337	365 960.30.425	960.30.475
.350	377 960.30.425	960.30.475
.362	390 960.30.450	960.30.500
.375	402 960.30.450	960.30.500
.387	415 960.30.475	960.30.525
.400	427 960.30.475	960.30.525



- **Components, trough "Basic":** ① Trough side parts, aluminum, 2 m ② Glide bar, plastic, 2 m ③ Glide strips, plastic, 2 m (without glide strips on request) ⑩ Optional: Silencer profile, rubber
- **Components, installation set "Basic":** ④ Bottom clamp, aluminum ⑤ C-profile, steel galvanized ⑥ Screw M6 x16 ⑦ Sliding nut M6 ⑧ Interface connector, plastic

Order example: Length of travel 30 m - Center mounted for Series E4.32.30.300.0 with $B_{Ri} = 327$

- Guide trough set (set of 2 trough side parts, incl. glide strips) **without** glide bar
Order text: 16 m guide trough without glide bar (8 x 2 m sections) Part No. **972.30.SL**
- Guide trough set (set of 2 trough side parts, incl. glide strips) **with** glide bar
Order text: 16 m guide trough with glide bar (8 x 2 m sections) Part No. **972.31.SL**
- Installation set "Basic" complete (guide trough-sets + 1)
Order text: 17 installation sets "Basic" Part No. **960.30.375**
- Module for the fixed end
Order text: 1 set Part No. **972.80**
- Option:** For an additional noise dampening with dampening profile, please add Index A Example: Part No. **972.30.SLA**

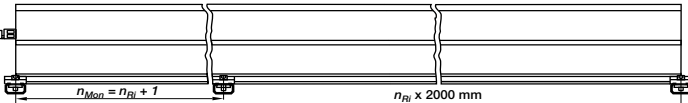

Principle sketch: Number of installation sets to be installed = **Number of trough sections + 1**



A quick fix for mounting the stationary end of an E-Chain®

With this module for the fixed end, fast and easy mounting onto the Aluminum "SuperTrough" is now possible without any drilling. Fast mounting of the E-Chain® by clamping onto the aluminum trough

- Quick relocation of the stationary end
- No drilling necessary ▶ [page 9.16](#)

Insert for the installation set "Heavy-Duty": **972.50.XXX** instead of (960.30.XXX) on the right column "attached outwards"

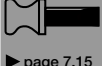
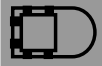

Standard

 Part. No.
Standard
 E-Chains®/E-Tubes

E4.32.30.R.0
 (Crossbar every link)

H4.32.30.R.0
 (Crossbar every 2nd link)

R4.32.30.R.0
 (E-Tube, closed)

Delivery time
 24h or today

Additional noise dampening with pads

 Part. No.
Low noise (with pads)
 E-Chains®/E-Tubes

ES4.32.30.R.0
 (Crossbar every link)

HS4.32.30.R.0
 (Crossbar every 2nd link)

RS4.32.30.R.0
 (E-Tube, closed)

Delivery time
 3-5 workdays

QuickLock crossbar - save up to 25% assembly time

 Part. No.
QuickLock crossbar*
 for inner radius

E4.32.30.QZ.R.0
 (Crossbar every link)

H4.32.30.QZ.R.0
 (Crossbar every 2nd link)

R4.32.30.QZ.R.0**
 (E-Tube, closed)

Delivery time
 3-5 workdays

 Part. No.
QuickLock crossbar*
 for Outer radius

QuickLock crossbars: smallest inner width from B/10 (100 mm)!

E4.32.30.QE.R.0
 (Crossbar every link)

H4.32.30.QE.R.0
 (Crossbar every 2nd link)

R4.32.30.QE.R.0**
 (E-Tube, closed)

Delivery time
 3-5 workdays

 Part. No.
QuickLock crossbar*
 both sides

E4.32.30.Q.R.0
 (Crossbar every link)

H4.32.30.Q.R.0
 (Crossbar every 2nd link)

R4.32.30.Q.R.0**
 (E-Tube, closed)

Delivery time
 3-5 workdays

 * available from fall 2009
 ** upon request

 * available from fall 2009
 ** upon request

 * available from fall 2009
 ** upon request

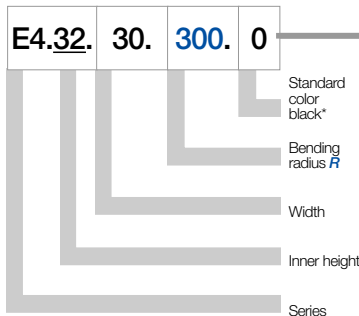
Order example - Standard

All E-Chains® made from igumid G are available in the colors listed in the table. Additional colors are usually feasible. (Standard color black). Colored E-Chains® are basically not available from stock.

Color options for igus® E-Chains® and E-Tubes. Standard color black (from stock)

E-Chains®/E-Tubes	igus® color index	Ral-numbers (approx.)	Delivery time
Material color			
black	Index .0	⇒ RAL 9004	from stock
white*	Index .1	⇒ RAL 9003	2-4 weeks
violet*	Index .5	⇒ RAL 4008	2-4 weeks
yellow*	Index .4	⇒ RAL 1018	2-4 weeks
orange*	Index .2	⇒ RAL 2003	2-4 weeks
red*	Index .6	⇒ RAL 3002	2-4 weeks
blue*	Index .8	⇒ RAL 5005	2-4 weeks
green*	Index .7	⇒ RAL 6011	2-4 weeks
grey*	Index .3 (E-Chains®)	⇒ RAL 7023	2-4 weeks
dusty grey*	Index .3 (E-Tubes)	⇒ RAL 7037	2-4 weeks
agate grey*	Index .11	⇒ RAL 7038	2-4 weeks
light grey*	Index .14	⇒ RAL 7035	2-4 weeks
black grey*	Index .13	⇒ RAL 7021	2-4 weeks
yellow/black*	Index .9	-	2-4 weeks

*Delivery Time and pricing for colored E-Chains® upon request

Easy turning of the outer link without rework

Reverse bending radius for circular movements

Unsupported lengths +25% possible

No burning-in of hot chips up to 850°C (1562° F)

ATEX/ESD classified E-Chains® - II 2 GD

Part. No.
NC-Material
E-Chains®/E-Tubes

Part. No.
RBR
E-Chains®/E-Tubes

Part. No.
XXL-Material*
E-Chains®/E-Tubes

Part. No.
HT-Material
only for E-Tubes

Part. No.
ESD-Material
E-Chains®/E-Tubes

E4.32.30.R.0.NC
(Crossbar every link)

E4.32.30.R1/R2.0
(Crossbar every link)

E4.32.30.R.0.XXL
(Crossbar every link)

R4.32.30.R.0.HT
Complete E-Tube*

E4.32.30.R.0.ESD
(Crossbar every link)

H4.32.30.R.0.NC
(Crossbar every 2nd link)

H4.32.30.R1/R2.0
(Crossbar every 2nd link)

H4.32.30.R.0.XXL
(Crossbar every 2nd link)

R4.32.30.HT.R.0
Lid and bottom

H4.32.30.R.0.ESD
(Crossbar every 2nd link)

R4.32.30.R.0.NC
(E-Tube, closed)

R4.32.30.R1/R2.0
(E-Tube, closed)

R4.32.30.R.0.XXL
(E-Tube, closed)

R4.32.30.HTZ.R.0
Bottom only

R4.32.30.R.0.ESD
(E-Tube, closed)

R4.32.30.HTE.R.0
Lid only

Delivery time
24h or today

Delivery time
3-5 workdays

Delivery time
1-2 weeks

Delivery time
up to 4 weeks

Delivery time
up to 2 weeks

*Sidelbands made from XXL-Material

*for gliding applications please consult igus®

Combination possibilities, examples:

	Low noise Option	QuickLock crossbar	NC-Version	RBR-Version	XXL-Material	HT-Material*	ESD-Material
Low noise Option		ES4.32.30.Q.R.0	ES4.32.30.R.0.NC	-	ES4.32.30.R.0.XXL	RS4.32.30.R.0.HT	ES4.32.30.R.0.ESD
QuickLock crossbar	ES4.32.30.Q.R.0		E4.32.30.Q.R.0.NC	E4.32.30.Q.R1/R2.0	E4.32.30.Q.R.0.XXL	-	E4.32.30.Q.R.0.ESD
NC-Version	ES4.32.30.R.0.NC	E4.32.30.Q.R.0.NC		-	-	R4.32.30.R.0.HT.NC	E4.32.30.R.0.ESD.NC
RBR-Version	-	E4.32.30.Q.R1/R2.0	-		-	R4.32.30.R1/R2.0.HT	E4.32.30.R1/R2.0.ESD
XXL-Material	ES4.32.30.R.0.XXL	E4.32.30.Q.R.0.XXL	-	-		-	-
HT-Material*	RS4.32.30.R.0.HT	-	R4.32.30.R.0.HT.NC	R4.32.30.R1/R2.0.HT	-		-
ESD-Material	ES4.32.30.R.0.ESD	E4.32.30.Q.R.0.ESD	E4.32.30.R.0.ESD.NC	E4.32.30.R1/R2.0.ESD	-	-	

*for gliding applications please consult igus®

Price index



Series E4.42 Series H4.42 Series R4.42



Low noise version
available with special
rubber pads design



Cleanroom test
upon request



ESD classification:
Electrically conductive ESD/ATEX
version upon request



Opening E-Chains: Remove crossbars and clips - Insert screwdriver into the slot, push down, release by lever action



Remove lids/bottoms (E-Tubes) - Insert screwdriver into the slot, release by lever action



When to use the Series E4.42/H4.42/R4.42:

- If a low-noise version is required
- At very high speeds and/or accelerations
- For long travels
- For high additional loads



When not to use it:

- When an extremely low vibration E-Chain®/E-Tube is required
- ▶ Series E6.40/R6.40, page 8.56/8.62
- When a one-sided snap open E-Chain®/E-Tube is required for economic reasons
- ▶ Series 3400/3450/3480/3500, page 5.126

- 1 Straight run through inner-/outer-link design
- 2 Low-noise operation through integrated brake in the radial stop dog system
- 3 By the undercut design, very high stiffening and carrying capacity when shear forces are at work
- 4 15% more tensile strength (compared to the best old E4 series), better unsupported length through improved stop dog system and vertical radial stops
- 5 Crossbar available for faster assembly/disassembly - 385.X.Q
- 6 New Interior separation kit available
- 7 Version NC "without pretension" simply by turning outer links without rework possible
- 8 Crossbars are removable along both radii
- 9 Hinged snap-open removable lids along outer radius of E-Tube
- 10 Wide, rounded plastic crossbars - cable friendly



Order example complete E-Chain®

Please indicate chain-lengths or number of links **Example: 5 m or 75 links**

5 m E4.42.20.300.0	E-Chain®
with 2 separators 382 assembled every 2 nd link	Interior separation
1 set E4.420.20.1.12.C	Mounting bracket



Unsupported length

FL_G = with straight upper run

FL_B = with permitted sag

Further information ► **Design, page 1.12**

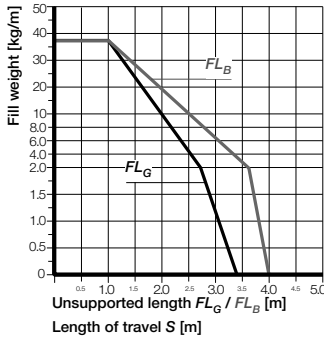
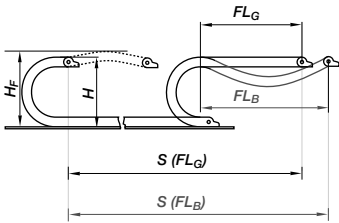

- S = Length of travel
- R = Bending radius
- H = Nominal clearance height
- H_F = Required clearance height
- H_{RI} = Trough inner height
- D = Overlength E-Chain® radius in final position
- $K = \pi \cdot R + \text{"safety"}$
- D_2 = Over length - long travels, gliding
- K_2 = *Further add-on
- H_2 = *Mounting height

*If the mounting bracket location is set lower

Other installation methods

- Vertical, hanging ≤ 100 m
- Vertical, standing ≤ 6 m
- Side mounted, unspupp. ≤ 2 m
- Rotary requires further calculation
- Unsupported length of upper run = upon request

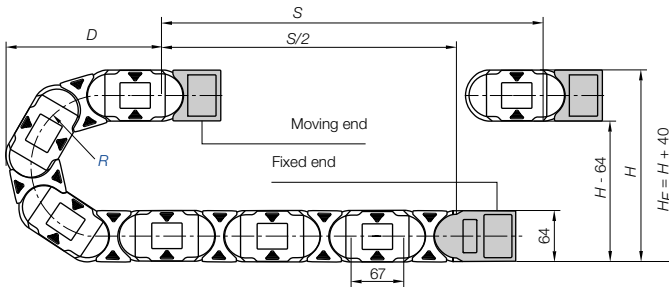

Pitch = 67 mm/link Links/m = 15 (1005 mm) Chain length = $S/2 + K$

R	075	100	125	150	175	200	250	300	350
H_{25}^0	214	264	314	364	414	464	564	664	764
D	174	199	224	249	274	299	349	399	449
K	370	450	530	610	685	765	920	1080	1235
H_2	214	264	186	186	186	186	186	186	186
D_{25}^{*25}	174	199	475	570	670	780	1030	1150	1500
K_2	370	450	804	938	1139	1340	1675	1943	2412



Short travels - unsupported

Unsupported E-Chains® feature positive camber over short travels. This must be accounted for when specifying the clearance height H_F . Please consult igus® if space is particularly restricted.

The required clearance height:
 $H_F = H + 40$ mm
(with 3,0 kg/m fill weight)

Long travel lengths from 10 m to max. 300 m Chain length = $S/2 + K_2$

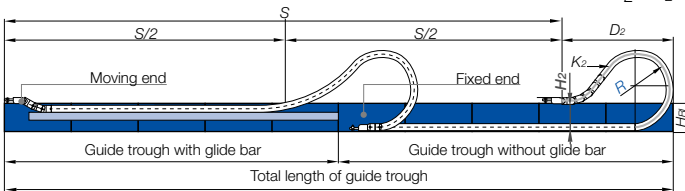

In case of travels between 4 and 10 m we recommend a longer unsupported length.



Gliding, long travel applications (max. 300 m)

In this case the E-Chain® upper run will be introduced in a guide trough on the lower run. We recommend to realize the engineering of such a plant by our technicians.

Technical Data

Speed / acceleration FL_G	max. 20 [m/s] / max. 200 [m/s ²]
Speed / acceleration FL_B	max. 3 [m/s] / max. 6 [m/s ²]
Gliding speed / acceleration (maximum)	max. 10 [m/s] / max. 50 [m/s ²]
Material - permitted temperature °C	igumid G / -40° up to +120° C
Flammability class, igumid G	VDE 0304 IIC UL94 HB



Details of material properties
► page 1.38

For support of the lower run - **Support Tray tool kit** available ► page 9.70

42

System E4.1
Inner height: 42 mm

Phone +49- (0) 22 03-96 49-800
Fax +49- (0) 22 03-96 49-222



► page 7.15

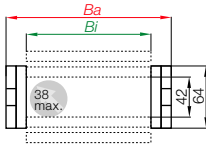

Part No. structure

E4.42. 400. 300. 0



Series E4.42 - E-Chain® with crossbars every link

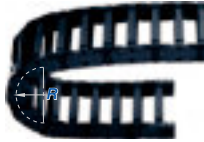

- Crossbars every link
- For rigid hydraulic hoses
- For applications particularly demanding
- Can be opened from two sides

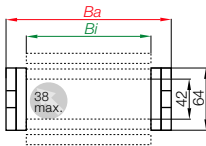

Part No. structure

H4.42. 400. 300. 0



Series H4.42 - E-Chain® with crossbars every 2nd link

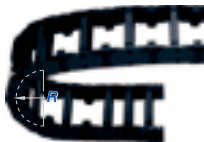

- Crossbars every 2nd link = Standard
- For nearly every situation
- Can be opened from two sides
- Easy assembly
- Stable
- Attractive price

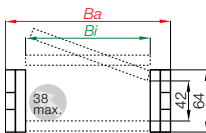

Part No. structure

R4.42. 25. 300. 0



Series R4.42 - Fully enclosed E-Tube



- Fully enclosed
- Excellent cable protection against dirt
- Protection against hot chips
- Lids along the entire inner radius are completely removable. Lids along the entire outer radius are single sided snap-open with a hinge on the other side to keep them attached to the chain or completely removable.



Part No.	<i>Bi</i>	<i>Ba</i>	E4.42	H4.42	R4.42	
	[mm]	[mm]	[kg/m]	[kg/m]	[kg/m]	
E4.42/H4.42/R4.42.05.	0*	50	76	1,923	1,804	2,150
E4.42/H4.42.06.	0	68	94	2,031	1,858	-
E4.42/H4.42/R4.42.07.	0	75	101	2,059	1,872	2,280
E4.42/H4.42/R4.42.087.	0	87	114	2,119	1,903	2,410
E4.42/H4.42/R4.42.10.	0	100	126	2,188	1,973	2,520
E4.42/H4.42/R4.42.11.	0	108	134	2,235	1,960	2,570
E4.42/H4.42.112.	0	112	139	2,247	1,966	-
E4.42/H4.42/R4.42.12.	0	125	151	2,341	2,014	2,730
E4.42/H4.42.137.	0	137	164	2,385	2,035	-
E4.42/H4.42/R4.42.15.	0	150	176	2,460	2,073	2,980
E4.42/H4.42.162.	0	162	189	2,484	2,085	-
E4.42/H4.42/R4.42.17.	0	168	194	2,553	2,119	3,150
E4.42/H4.42.18.	0	175	201	2,571	2,128	-
E4.42/H4.42.187.	0	187	214	2,610	2,148	-
E4.42/H4.42/R4.42.20.	0	200	226	2,715	2,200	3,450
E4.42/H4.42.212.	0	212	239	2,757	2,221	-
E4.42/H4.42.23.	0	225	251	2,841	2,263	-
E4.42/H4.42.237.	0	237	264	2,865	2,275	-
E4.42/H4.42/R4.42.25.	0	250	276	2,979	2,332	4,250
E4.42/H4.42.262.	0	262	289	3,048	2,367	-
E4.42/H4.42.28.	0	275	301	3,108	2,397	-
E4.42/H4.42.29.	0	287	314	3,136	2,411	-
E4.42/H4.42/R4.42.30.	0	300	326	3,243	2,464	4,890
E4.42/H4.42.312.	0	312	339	3,262	2,474	-
E4.42/H4.42.325.	0	325	351	3,348	2,517	-
E4.42/H4.42.337.	0	337	364	3,399	2,542	-
E4.42/H4.42.350.	0	350	376	3,588	2,637	-
E4.42/H4.42.362.	0	362	389	3,669	2,677	-
E4.42/H4.42.375.	0	375	402	3,730	2,708	-
E4.42/H4.42.387.	0	387	414	3,786	2,736	-
E4.42/H4.42.400.	0	400	426	3,840	2,763	-

*Removable lid only, no hinged option · **not available for R4.42

Available bending radii

R [mm] 075** 100** 125 150 175 200 250 300 350

Supplement Part No. with required radius. Example: E4.42.400.300.0

0 = standard color, other colors ▶ page 1.39 · Pitch: 67 mm/link - Links/m = 15



Order-key for further options and versions for this series ▶ page 7.60

System E4.1

Inner height: 42 mm

Phone +49- (0) 22 03-96 49-800

Fax +49- (0) 22 03-96 49-222



Extender crossbar for large diameter hoses ▶ page 7.56



▶ page 7.15

Single crossbar, E-Chain®, Part No. 385.Bi

Single lid, E-Tube, Part No. 785.Bi

Outer side link, single part Part No. E4.42.01 (suitable for all radii)

Inner side link, single part Part No. E4.42.02. R

Single bottom, Part No. 786.Bi

Part No. E-Chain® links, single parts

Inner side link

Outer side link

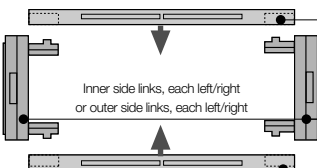

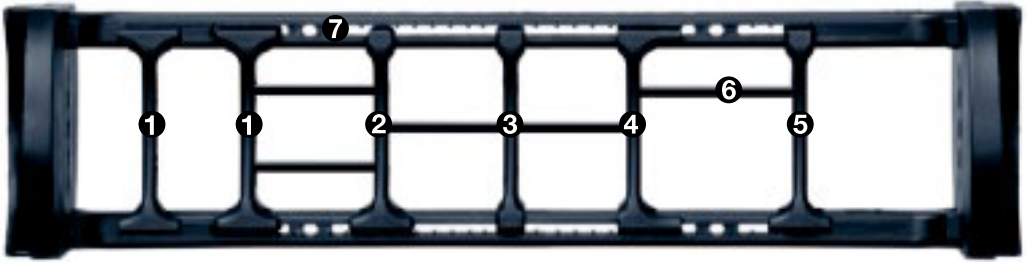

Optimized and extended interior separation range for Series E4.42. Wear optimized geometry with a high locking strength. The very cable friendly design increases your cables cycle life even further. Universally suitable for E-Chains® and E-Tubes, 3x slotted!

Phone +49- (0) 22 03-96 49-800
Fax +49- (0) 22 03-96 49-222

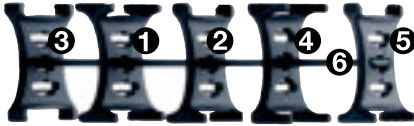

- ① Standard Separator, wide foot - Part. No. 42.1
- ② Separator for QuickLock crossbar - Part. No. 42.2
- ③ Narrow separator - Part. No. 42.3
- ④ Asymmetric separator - Part. No. 42.4
- ⑤ Notch separator - Part. No. 42.5

Realize a better separation with fewer, standardized parts

- Optimized and extended interior separation range
- The very cable friendly design increases your cables cycle life even further
- Same separation for E-Chains® and E-Tubes
- Safe force closure connection
- Cable friendly plastic crossbars, optimized for low cable wear and long cycle life
- Faster and easier assembly

igus® GmbH
51147 Cologne



⑥ Functionality - full-width shelf, lockable - Part. No. 3200.XX

⑥ For horizontal separation: Full-width shelf

- Shelf locks safely into separators on both ends through special locking clip
- Separators can be moved freely over the shelf in horizontal direction
- No side plates necessary
- Partial horizontal shelving possible



⑦ Standard* for all E4 crossbars and lids/bottoms: lock-in and scaling

*First few sizes available. Completion of the product range by the end of 2009

⑦ Notch crossbars, notch bottoms and lids

- No additional spacers necessary for side-mounted applications
- High locking strength of the separator in lock-in position
- Clearly visible, plane scaling
- Clearly notches and scaling on crossbars for E-Chains® and bottoms and lids of E-Tubes

Internet: www.igus.eu
E-mail: info@igus.de

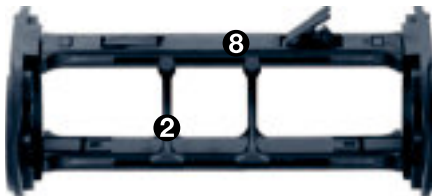

⑧ QuickLock crossbar, single part - Part No. 385.X.Q
(X = Inner width Bi E-Chains® / Q = QuickLock)

⑧ Optimized QuickLock crossbar

- One-click opening of the QuickLock crossbar = 25 % faster assembly compared to standard crossbars
 - Quick assembly/disassembly
 - Faster assembly with less effort
 - Free access to the top, E-Chain® can remain in the guide through
- www.igus.de/en/E4schnelleMontage

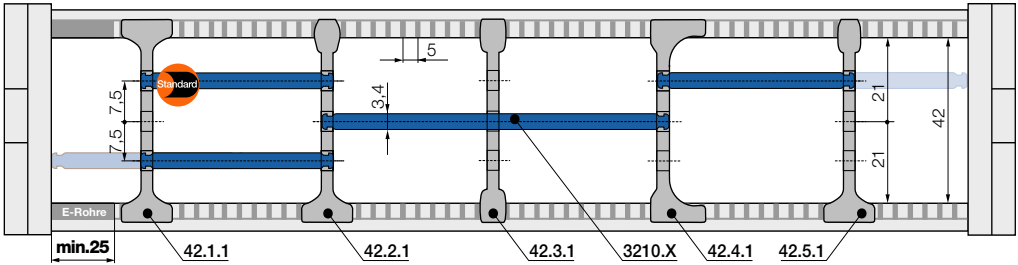

In the standard configuration, a separator is mounted at every second chain link!

Note: Observe a lateral spacing of at least 25 mm (E-Tube)!

Standard - for all applications

① Separator with wide foot for maximum locking strength and safe standing in E-Chains® and E-Tubes

For even faster installation

② Separator for igus® ③ QuickLock crossbar 385.X.Q. Firm hold to one side with a wide foot, narrow on opposed side for easy cable assembly (slight grip)

For many thin cables

④ Separator with narrow feet for a large number of thin cables side by side. Saves space in E-Chains® and E-Tubes.

Fore side-mounted applications

⑤ Asymmetrical separator, for defined distance. No additional spacers necessary for E-Chains® and E-Tubes

Locks safely onto in 5 mm increments

⑥ Notch separator for ⑦ the new notch crossbar. With scaling on the notch crossbars. For exact positioning in E-Chains® and E-Tubes

Horizontal separation

⑧ Full-width shelf (Inner widths 50 - 250 mm). Shelf locks safely into separators on both ends, fixed width possible. Separators can be moved freely over the shelf in horizontal direction. Usable in 3 levels.

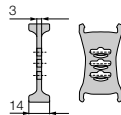

Standard separator, wide foot

unassembled 42.1
assembled 42.1.1

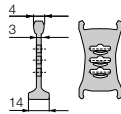

Separator for QuickLock crossbar

unassembled 42.2
assembled 42.2.1

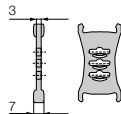

Separator, narrow foot

unassembled 42.3
assembled 42.3.1

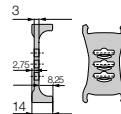

Asymmetrical separator

unassembled 42.4
assembled 42.4.1

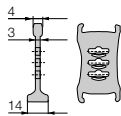

Notch separator

unassembled 42.5
assembled 42.5.1

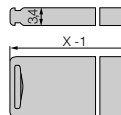

Full-width shelf, lockable

unassembled 3200.X
assembled 3210.X

XX = Width - see table below!

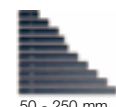

50 - 250 mm

Width	Part No.	Part No.	Width	Part No.	Part No.
X [mm]	unassembled	assembled	X [mm]	unassembled	assembled
050	3200.050	3210.050	150	3200.150	3210.150
075	3200.075	3210.075	175	3200.175	3210.175
100	3200.100	3210.100	200	3200.200	3210.200
115	3200.115	3210.115	225	3200.225	3210.225
125	3200.125	3210.125	250	3200.250	3210.250

Phone +49- (0) 22 03-96 49-800
Fax +49- (0) 22 03-96 49-222



► page 7.15



Interior separation configurator online ► www.igus.eu/iaconfigurator



Standard 02 - Proven and tested interior separation elements for special and extremely variable partitioning! For use with many cables of differing diameters. E-Chains® and E-Tubes can be subdivided both vertically and horizontally.

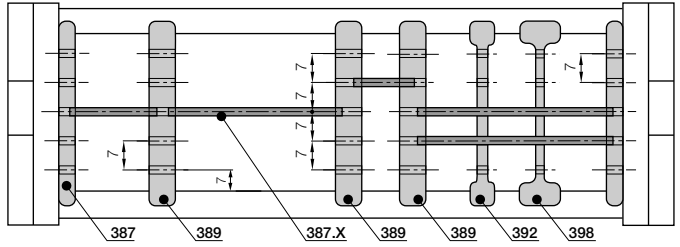

Split separator T423, to be split for shelf 386.X



Side plate 386



Middle plate 388



Slotted separator 391



Open slotted separator 397



Shelf 386.X

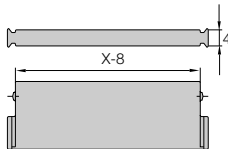

Split separator for E-Chains®	
unassembled	T423
assembled	T423M



Side plate for E-Chains®/E-Tubes	
unassembled	386
assembled	387



Middle plate for E-Chains®/E-Tubes	
unassembled	388
assembled	389



Slotted separator for E-Chains®/E-Tubes	
unassembled	391
assembled	392



Open slotted separator for E-Chains®/E-Tubes	
unassembled	397
assembled	398



More proven interior separation elements

● **Split separator T423** - ideal for subsequent shelving or for the initial assembly of the E-Chain®. Fast assembly and disassembly possible through hinge/push mechanism. Saves assembly time. Enhances flexibility. (For Shelf 386.X).

● **Side plates 386, middle plates 388 and shelves 386.X** form the basic pattern of a shelf system. Shelves of various widths can be arranged at 5 different heights (in 7 mm increments).

● **Slotted separators 391**, are used for very fine subdivisions. However, they cannot be retrofitted into an existing separation system without dismantling the interior separators first.

● The unilateral **Open slotted separator 397** can be retrofitted into an existing interior separation system without a need for dismantling the interior separators. During an installation of open slotted separators, the top and bottom notches cannot be occupied by shelves.

Width X [mm]	Part No. unassembled	Part No. assembled
018	386.18	387.18
023	386.23	387.23
025	386.25	387.25
028	386.28	387.28
033	386.33	387.33
043	386.43	387.43
050	386.50	387.50
054	386.54	387.54
062	386.62	387.62

Width X [mm]	Part No. unassembled	Part No. assembled
075	386.75	387.75
087	386.87	387.87
100	386.100	387.100
108	386.108	387.108
125	386.125	387.125
150	386.150	387.150
175	386.175	387.175
200	386.200	387.200
208	386.208	387.208

For new constructions, we recommend the new igus® interior separation kit
Previous interior separation - will continue to be available!

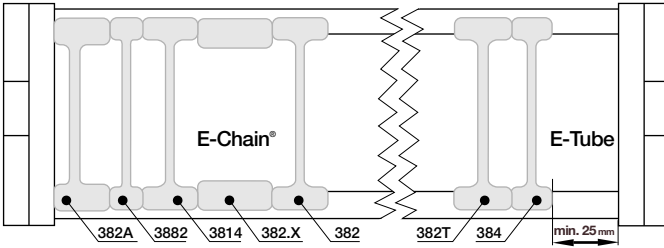

Vertical separators are used if a vertical subdivision is required. In the standard configuration, a separator is mounted at every second E-Chain® link. **Note:** Observe a lateral spacing of at least 25 mm (E-Tube)!

Vertical separators and spacers

- **Standard separator 381 for E-Chains®** offers safe stability due to its broad foot design, also when used with thick cables or hoses.
- **Vertical separator 3881 with a narrow foot (7 mm) for E-Chains®** with applications where a large number of small cables need to be individually separated.
- The **vertical separator 381T for E-Tubes** clamps to the fixed radius and remains free along the other radius to facilitate lid removal. If installing these yourself, please ensure that they are identically aligned.
- Separators (e.g. "side mounted") for E-Chains® can be fixed in their position with **spacers 381.XX**. The available inner height will be reduced by 2 mm, per spacer and side. To avoid this, the parts can be assembled on outside of the crossbar (not for long travels) **XX = width of the spacer** (available 10, 15 and 20)



Vertical separator for E-Chains®	
unassembled	381
assembled	382



Vertical separator* for E-Chains®	
unassembled	3881
assembled	3882



Vertical separator for E-Tubes	
unassembled	381T
assembled	382T



Spacer* for E-Chains®	
unassembled	381.XX
assembled	382.XX

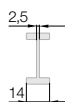

Locking separator for E-Chains®	
unassembled	3804
assembled	3814



Locking separator for E-Tubes	
unassembled	383
assembled	384

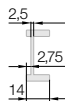

Asymmetric separator for E-Chains®	
unassembled	381A
assembled	382A

*For side-mounted applications



Vertical separator
381



Vertical separator with a narrow foot
3881



Vertical separator
381T



Spacer
381.XX



Locking separator
3804



Locking separator
383



Asymmetric separator
381A

System E4.1
Inner height: 42 mm

Phone +49- (0) 22 03-96 49-800
Fax +49- (0) 22 03-96 49-222





Extension links - for extremely wide E-Chains® up to 3 m

- For applications in which particularly high fill weights necessitate extremely wide E-Chains® (up to 3000 mm)
- The extension link design allows virtually limitless side-by-side attachment of chains
- The unsupported length of a chain can be increased when additional loads are required
- Extension links can be used with E-Chains®, E-Tubes or as a combination of both
- They are suitable for unsupported and gliding applications in a guide trough
- E-Chains® with extension links are attached with KMA or steel mounting brackets



Part No. structure

E4.42.10 /20 /10. 200.0

E4.42.Bi1/Bi2/Bi3. R.0

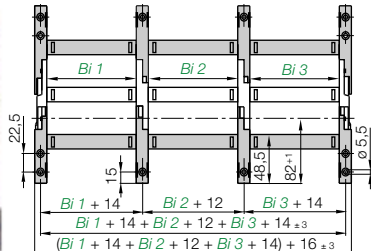

Extender crossbars - careful guide of hoses applications

- Suitable for hoses with a maximum outer diameter of 115 mm
- Gliding operation with crossbars assembled along the outer radius and a special guide trough
- Gliding operation not guaranteed with crossbars assembled along the inner radius
- The extender crossbar can either be attached to the side links directly or can be used in combination with two stranded snap-open crossbars

Consult igus® for your extender crossbar applications. We are happy to assist you with your design layout

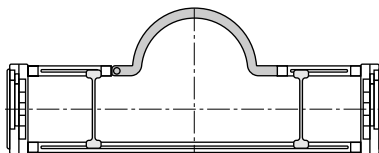

385.15RHD115 round extender crossbar combined with snap-open crossbars

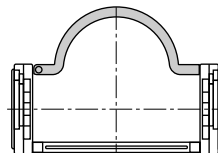

385.18RD115 round strap attached directly on the side link

Part No.	Max Ø [mm] hose	Form	Installation side link	Combination with snap-open crossb.
385.15.RHD115	115	○	-	+
385.18.RD115	115	○	+	-

○ = round + = yes / - = no



Hinged crossbars

- Typically E-Chain® crossbars are completely removable. For cases where the snap-open crossbars have to remain at the open link of the E-Chain®, a hinged design has been developed
- Length: 37,5 mm **Part No. 385.02** / snap-open crossbar (shortened): Bi-37,5 mm **Part No. 385.03**
- Please consult igus® for design assistance

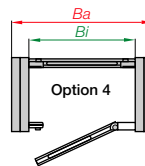
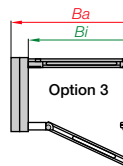
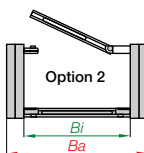
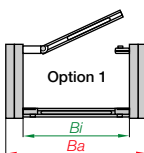
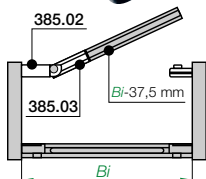

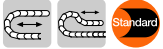

The Standard - Option KMA* - pivoting

- Recommended for unsupported and gliding applications
- Universal mountable with attachment capability on all sides
- Bolted connection outside of chain cross-section
- Confined installation conditions
- Corrosion resistant

*KMA = Polymer Metal Mounting Bracket

Moving end

E4.420/R4.420...□.2

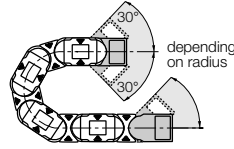

Fixed end

E4.420/R4.420...□.1



The attachment variants arising automatically by the choice of the KMA mounting bracket

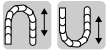
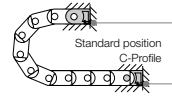

Option KMA - locking

- Recommended for vertical hanging / standing applications

Additionally:

- Universal mountable
- C-profile option
- Corrosion resistant
- Locked connections
- At very high acceleration

Moving end

E4.421/R4.421...□.2

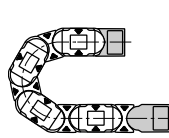

Fixed end

E4.421/R4.421...□.1



The attachment variants arising automatically by the choice of the KMA mounting bracket

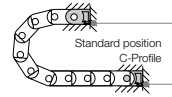

Fixed end

E4.420/R4.420...□.1 (pivoting)

E4.421/R4.421...□.1 (locking)

Moving end

(pivoting) E4.420/R4.420...□.2

(locking) E4.421/R4.421...□.2

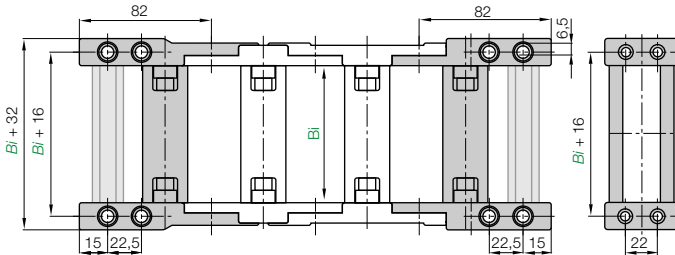

Dimensions and order configurations

Part No. structure (pivoting)

E4.420, R4.420, 05, 2, 12, C

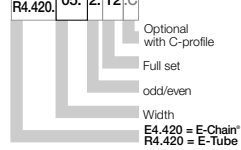

Part No. structure (locking)

E4.421, R4.421, 05, 2, 12, C

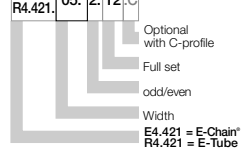

Note: The E4.1 System may end with either an inner side or an outer side link.

Keep in mind that an outer side link always forms the first chain link at the moving end. The Part No. depend on an even or odd numbers of links. Please insert: **1** for odd number of links or **2** for even number of links

Full set, for both ends:

E4.420, 05, 2, 12, C (even)

Single-part order:

E4.420, 05, 2, 12, C (even)

Mounting bracket moving end

E4.420, 05, 2, 1, C (even)

Mounting bracket fixed end

Width index	Part No. full set pivoting	locking	Bi [mm]	Width index	Part No. full set pivoting	locking	Bi [mm]
.05	E4/R4.420	E4.421	.05, □.12, C 50	.23	E4.420	E4.421	.23, □.12, C 225
.06	E4.420	E4.421	.06, □.12, C 68	.237	E4.420	E4.421	.237, □.12, C 237
.07	E4/R4.420	E4/R4.421	.07, □.12, C 75	.25	E4/R4.420	E4/R4.421	.25, □.12, C 250
.087	E4.420	E4.421	.087, □.12, C 87	.262	E4.420	E4.421	.262, □.12, C 262
.10	E4/R4.420	E4/R4.421	.10, □.12, C 100	.28	E4.420	E4.421	.28, □.12, C 275
.11	E4/R4.420	E4/R4.421	.11, □.12, C 108	.29	E4.420	E4.421	.29, □.12, C 287
.112	E4.420	E4.421	.112, □.12, C 112	.30	E4/R4.420	E4/R4.421	.30, □.12, C 300
.12	E4/R4.420	E4/R4.421	.12, □.12, C 125	.312	E4.420	E4.421	.312, □.12, C 312
.137	E4.420	E4.421	.137, □.12, C 137	.325	E4.420	E4.421	.325, □.12, C 325
.15	E4/R4.420	E4/R4.421	.15, □.12, C 150	.337	E4.420	E4.421	.337, □.12, C 337
.162	E4.420	E4.421	.162, □.12, C 162	.350	E4.420	E4.421	.350, □.12, C 350
.17	E4/R4.420	E4/R4.421	.17, □.12, C 168	.362	E4.420	E4.421	.362, □.12, C 362
.18	E4.420	E4.421	.18, □.12, C 175	.375	E4.420	E4.421	.375, □.12, C 375
.187	E4.420	E4.421	.187, □.12, C 187	.387	E4.420	E4.421	.387, □.12, C 387
.20	E4/R4.420	E4/R4.421	.20, □.12, C 200	.400	E4.420	E4.421	.400, □.12, C 400
.212	E4.420	E4.421	.212, □.12, C 212				

Please insert **1** for odd number of links or **2** for even number of links



Chainfix steel clamps and Chainfix stainless-steel clamps - max. pull forces, adjustable with hexagon socket. Available as single, double or triple clamps

Chainfix clamps for the C-profile

Part No. single clamps		Part No. double clamps		Part No. triple clamps		Cable
steel	stainless steel	steel	stainless steel	steel	stainless steel	ø [mm]
CFX12.1	CFX12.1.E	CFX12.2	CFX12.2.E	CFX12.3	-	06 - 12
CFX14.1	CFX14.1.E	CFX14.2	CFX14.2.E	CFX14.3	-	12 - 14
CFX16.1	CFX16.1.E	CFX16.2	CFX16.2.E	CFX16.3	-	14 - 16
CFX18.1	CFX18.1.E	CFX18.2	CFX18.2.E	CFX18.3	-	16 - 18
CFX20.1	CFX20.1.E	CFX20.2	CFX20.2.E	CFX20.3	-	18 - 20
CFX22.1	CFX22.1.E	CFX22.2	CFX22.2.E	CFX22.3	-	20 - 22
CFX26.1	CFX26.1.E	CFX26.2	CFX26.2.E	-	-	22 - 26
CFX30.1	CFX30.1.E	CFX30.2	CFX30.2.E	-	-	26 - 30
CFX34.1	CFX34.1.E	CFX34.2	CFX34.2.E	-	-	30 - 34
CFX38.1	CFX38.1.E	-	-	-	-	34 - 38
CFX42.1	CFX42.1.E	-	-	-	-	38 - 42



Chainfix Clip - Modular snap-on strain relief device for C-profile

Available for all igus® E-ChainSystems® with C-profiles and also suitable for assembly in the KMA mounting brackets and Clip-on strain relief for crossbars. High pull forces, plug-in modular snap-on strain relief device. **Details ▶ chapter 10**

Cable ø [mm]	Part No. clamp	Part No. bottom part
04 - 08	CFC-08-M	CFC-08-C
08 - 12	CFC-12-M	CFC-12-C
12 - 16	CFC-16-M	CFC-16-C
16 - 20	CFC-20-M	CFC-20-C
20 - 24	CFC-24-M	CFC-24-C



Chainfix Nugget for the C-Profile

Strain relief for the fixation of cables up to a diameter of Ø 30 mm. Easy to assemble, without any screws and tools. Easy strain relief due to fixation with pre-harnessed cable strap, very small space requirement. **Details ▶ chapter 10**

Part No.	ø max. conduit [mm]	Width [mm]
CFN.20	20	10,8
CFN.30.52	30	16,8
CFN.20.N35	20	20,0

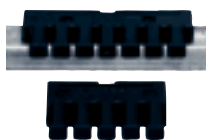

Chainfix tiwrap plates with clip-on connection for the C-profile

Can be plugged into the KMA C-profile. Easy to assemble without any screws. Easily solvable with screwdriver nevertheless safe stop. For all E-Chains® with KMA and integrated C-profile. **Details ▶ chapter 10**

Part No.	Width of strain relief [mm]	Number of teeth
3050.ZC	50	5
3075.ZC	75	7

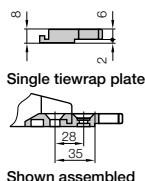

Chainfix tiwrap plate as individual part

As individual component screwed on KMA, can also be plugged into the mounting bracket. **Details ▶ chapter 10**

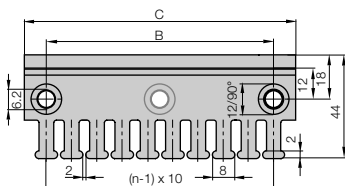

Tiwrap plate	No. of teeth	Dim. C [mm]	Dim. B [mm]	Center bore
3050.ZB	5	50	30	-
3075.ZB	7	75	55	-
3100.ZB	10	100	80	-
3115.ZB	11	115	95	-
3125.ZB	12	125	105	-
3150.ZB	15	150	130	-
3175.ZB	17	175	155	-
3200.ZB	20	200	180	+
3225.ZB	22	225	205	+
3250.ZB	25	250	230	+

(- = no / + = yes)

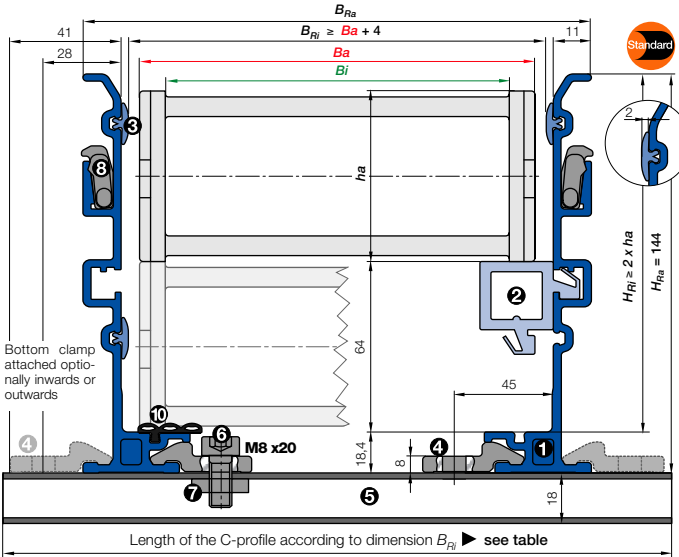

- B_a = Outer width E-Chains* / E-Tube
- B_i = Inner width E-Chains* / E-Tube
- h_a = Outer height E-Chains* / E-Tube
- H_{Ri} = Inner trough height
- H_{Ra} = Outer trough height
- B_{Ri} = Inner trough width ▶ depends on dim. B_a
- B_{Ra} = Outer trough width
- n_{Mon} = Number of installation sets (left/right)
- n_{Ri} = Number of trough sets (left/right)
- $H_{Ri} \geq 2 \cdot h_a$
- $B_{Ri} \geq B_a + 4$
- = Guide trough set ● = Glide bar
- = Installation set "Basic" ● = C-Profile

Installation set "Basic" with C-Profile

Bottom Clamp attached optionally inwards or outwards

E4.42.05.300.0 ▶ Order example

B_{Ri} [mm]	Part No.	
	attached inwards	attached outwards
.05 80	-	960.40.200
.06 98	-	960.40.225
.07 105	-	960.40.225
.087 118	960.40.175	960.40.250
.10 130	960.40.200	960.40.250
.11 138	960.40.200	960.40.275
.112 143	960.40.200	960.40.275
.12 155	960.40.225	960.40.275
.137 168	960.40.225	960.40.300
.15 180	960.40.250	960.40.300
.162 193	960.40.250	960.40.325
.17 198	960.40.250	960.40.325
.18 205	960.40.275	960.40.325
.187 218	960.40.275	960.40.350
.20 230	960.40.300	960.40.350
.212 243	960.40.300	960.40.375
.23 255	960.40.325	960.40.375
.237 268	960.40.325	960.40.400
.25 280	960.40.350	960.40.400
.262 293	960.40.350	960.40.425
.28 305	960.40.375	960.40.425
.29 318	960.40.375	960.40.450
.30 330	960.40.400	960.40.450
.312 343	960.40.400	960.40.475
.325 355	960.40.425	960.40.475
.337 368	960.40.425	960.40.500
.350 380	960.40.450	960.40.500
.362 393	960.40.450	960.40.525
.375 406	960.40.475	960.40.525
.387 418	960.40.475	960.40.550
.400 430	960.40.500	960.40.550



- **Components, trough "Basic":** ① Trough side parts, aluminum, 2 m ② Glide bar, plastic, 2 m ③ Glide strips, plastic, 2 m (without glide strips on request) ⑩ Optional: Silencer profile, rubber
- **Components, installation set "Basic":** ④ Bottom clamp, aluminum ⑤ C-profile, steel galvanized ⑥ Screw M8 x20 ⑦ Sliding nut M8 ⑧ Interface connector, plastic

Order example: Length of travel 30 m - Center mounted for Series E4.42.20.300.0 with $B_{Ri} = 230$

- Guide trough set (set of 2 trough side parts, incl. glide strips) **without** glide bar
Order text: 16 m guide trough without glide bar (8 x 2 m sections) Part No. 973.30.SL
- Guide trough set (set of 2 trough side parts, incl. glide strips) **with** glide bar
Order text: 16 m guide trough with glide bar (8 x 2 m sections) Part No. 973.31.SL
- Installation set "Basic" complete (guide trough-sets + 1)
Order text: 17 installation sets "Basic" Part No. 960.40.300
- Module for the fixed end
Order text: 1 set Part No. 973.81
- Option:** For an additional noise dampening with dampening profile, please add Index A Example:
Part No. 973.30.SLA

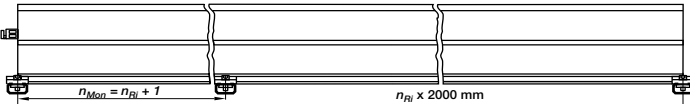

Principle sketch: Number of installation sets to be installed = Number of trough sections + 1

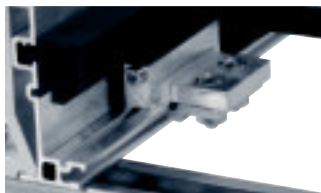

A quick fix for mounting the stationary end of an E-Chain®

With this module for the fixed end, fast and easy mounting onto the Aluminum "SuperTrough" is now possible without any drilling. Fast mounting of the E-Chain® by clamping onto the aluminum trough

- Quick relocation of the stationary end
- No drilling necessary ▶ page 9.16

Insert for the installation set "Heavy-Duty": **973.50.XXX** instead of (960.40.XXX) on the right column "attached outwards"

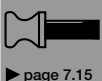

Standard

 Part. No.
Standard
 E-Chains®/E-Tubes

E4.42.30.R.0
 (Crossbar every link)

H4.42.30.R.0
 (Crossbar every 2nd link)

R4.42.30.R.0
 (E-Tube, closed)

Delivery time
 24h or today

Additional noise dampening with pads

 Part. No.
Low noise (with pads)
 E-Chains®/E-Tubes

ES4.42.30.R.0
 (Crossbar every link)

HS4.42.30.R.0
 (Crossbar every 2nd link)

RS4.42.30.R.0
 (E-Tube, closed)

Delivery time
 3-5 workdays

QuickLock crossbar - save up to 25% assembly time

 Part. No.
QuickLock crossbar*
 for inner radius

E4.42.30QZ.R.0
 (Crossbar every link)

H4.42.30QZ.R.0
 (Crossbar every 2nd link)

R4.42.30QZ.R.0**
 (E-Tube, closed)

Delivery time
 3-5 workdays

 Part. No.
QuickLock crossbar*
 for Outer radius

QuickLock crossbars: smallest inner width from B/10 (100 mm)!

E4.42.30QE.R.0
 (Crossbar every link)

H4.42.30QE.R.0
 (Crossbar every 2nd link)

R4.42.30QE.R.0**
 (E-Tube, closed)

Delivery time
 3-5 workdays

 Part. No.
QuickLock crossbar*
 both sides

E4.42.30Q.R.0
 (Crossbar every link)

H4.42.30Q.R.0
 (Crossbar every 2nd link)

R4.42.30Q.R.0**
 (E-Tube, closed)

Delivery time
 3-5 workdays

 * available from fall 2009
 ** upon request

 * available from fall 2009
 ** upon request

 * available from fall 2009
 ** upon request

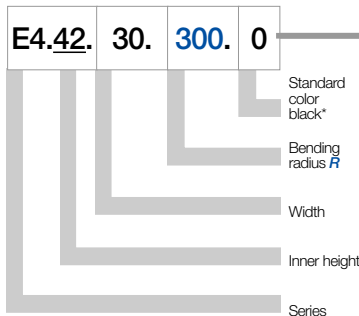
Order example - Standard

All E-Chains® made from igumid G are available in the colors listed in the table. Additional colors are usually feasible. (Standard color black). Colored E-Chains® are basically not available from stock.

Color options for igus® E-Chains® and E-Tubes. Standard color black (from stock)

E-Chains®/E-Tubes	igus® color index	Ral-numbers (approx.)	Delivery time
Material color			
black	Index .0	⇒ RAL 9004	from stock
white*	Index .1	⇒ RAL 9003	2-4 weeks
violet*	Index .5	⇒ RAL 4008	2-4 weeks
yellow*	Index .4	⇒ RAL 1018	2-4 weeks
orange*	Index .2	⇒ RAL 2003	2-4 weeks
red*	Index .6	⇒ RAL 3002	2-4 weeks
blue*	Index .8	⇒ RAL 5005	2-4 weeks
green*	Index .7	⇒ RAL 6011	2-4 weeks
grey*	Index .3 (E-Chains®)	⇒ RAL 7023	2-4 weeks
dusty grey*	Index .3 (E-Tubes)	⇒ RAL 7037	2-4 weeks
agate grey*	Index .11	⇒ RAL 7038	2-4 weeks
light grey*	Index .14	⇒ RAL 7035	2-4 weeks
black grey*	Index .13	⇒ RAL 7021	2-4 weeks
yellow/black*	Index .9	–	2-4 weeks

*Delivery Time and pricing for colored E-Chains® upon request

Easy turning of the outer link without rework

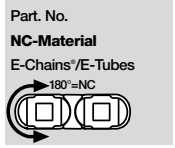

E4.42.30.R.0.NC
(Crossbar every link)

H4.42.30.R.0.NC
(Crossbar every 2nd link)

R4.42.30.R.0.NC
(E-Tube, closed)

Delivery time
24h or today

Reverse bending radius for circular movements

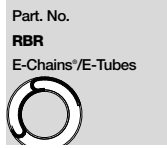

E4.42.30.R1/R2.0
(Crossbar every link)

H4.42.30.R1/R2.0
(Crossbar every 2nd link)

R4.42.30.R1/R2.0
(E-Tube, closed)

Delivery time
3-5 workdays

Unsupported lengths +25% possible

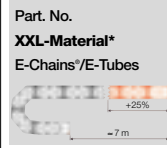

E4.42.30.R.0.XXL
(Crossbar every link)

H4.42.30.R.0.XXL
(Crossbar every 2nd link)

R4.42.30.R.0.XXL
(E-Tube, closed)

Delivery time
1-2 weeks

*Sidelbands made from XXL-Material

No burning-in of hot chips up to 850°C (1562° F)



R4.42.30.R.0.HT
Complete E-Tube*

R4.42.30.HT.R.0
Lid and bottom

R4.42.30.HTZ.R.0
Bottom only

R4.42.30.HTE.R.0
Lid only

Delivery time
up to 4 weeks

*for gliding applications please consult igus®

ATEX/ESD classified E-Chains® - II 2 GD

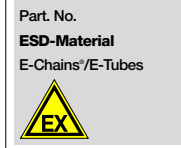

E4.42.30.R.0.ESD
(Crossbar every link)

H4.42.30.R.0.ESD
(Crossbar every 2nd link)

R4.42.30.R.0.ESD
(E-Tube, closed)

Delivery time
up to 2 weeks

Combination possibilities, examples:

	Low noise Option	QuickLock crossbar	NC-Version	RBR-Version	XXL-Material	HT-Material*	ESD-Material
Low noise Option		ES4.42.30.Q.R.0	ES4.42.30.R.0.NC	-	ES4.42.30.R.0.XXL	RS4.42.30.R.0.HT	ES4.42.30.R.0.ESD
QuickLock crossbar	ES4.42.30.Q.R.0		E4.42.30.Q.R.0.NC	E4.42.30.Q.R1/R2.0	E4.42.30.Q.R.0.XXL	-	E4.42.30.Q.R.0.ESD
NC-Version	ES4.42.30.R.0.NC	E4.42.30.Q.R.0.NC		-	-	R4.42.30.R.0.HT.NC	E4.42.30.R.0.ESD.NC
RBR-Version	-	E4.42.30.Q.R1/R2.0	-		-	R4.42.30.R1/R2.0.HT	E4.42.30.R1/R2.0.ESD
XXL-Material	ES4.42.30.R.0.XXL	E4.42.30.Q.R.0.XXL	-	-		-	-
HT-Material*	RS4.42.30.R.0.HT	-	R4.42.30.R.0.HT.NC	R4.42.30.R1/R2.0.HT	-		-
ESD-Material	ES4.42.30.R.0.ESD	E4.42.30.Q.R.0.ESD	E4.42.30.R.0.ESD.NC	E4.42.30.R1/R2.0.ESD	-	-	

*for gliding applications please consult igus®

Price index



Series E4.56

SerieH4.56

Series R4.56



Low noise version
available with special
rubber pads design



Cleanroom test
upon request



ESD classification:
Electrically conductive ESD/ATEX
version upon request



Opening E-Chains: Remove crossbars and clips - Insert screwdriver into the slot, push down, release by lever action



Remove lids/bottoms (E-Tubes) - Insert screwdriver into the slot, release by lever action



When to use the Series E4.56/H4.56/R4.56:

- If a low-noise version is required
- At very high speeds and/or accelerations
- For long travels
- For high additional loads



When not to use it:

- When an extremely low vibration E-Chain®/E-Tube is required
- ▶ Series E6.52, page 8.66
- If the stability of a "light" version with thinner side parts is required due to cost- and space reasons
- ▶ Series 14040/14140/R18840, page 7.124

- 1 Straight run through inner-/outer-link design
- 2 Low-noise operation through integrated brake in the radial stop dog system
- 3 By the undercut design, very high stiffening and carrying capacity when shear forces are at work
- 4 15% more tensile strength (compared to the best old E4 series), better unsupported length through improved stop dog system and vertical radial stops
- 5 Crossbar available for faster assembly/disassembly - 450.X.Q
- 6 New Interior separation kit available
- 7 Version NC "without pretension" simply by turning outer links without rework possible
- 8 Crossbars are removable along both radii
- 9 Hinged snap-open removable lids along outer radius of E-Tube
- 10 Wide, rounded plastic crossbars - cable friendly



Order example complete E-Chain®

Please indicate chain-lengths or number of links **Example: 3 m or 33 links**

3 m **E4.56.30.300.0**

E-Chain®

with 2 separators **411** assembled every 2nd link

Interior separation

1 set **E4.560.30.1.12.C**

Mounting bracket



Unsupported length

FL_G = with straight upper run

FL_B = with permitted sag

Further information ► **Design, page 1.12**

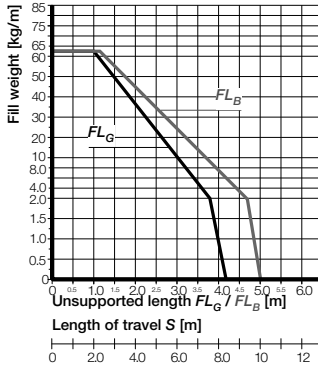
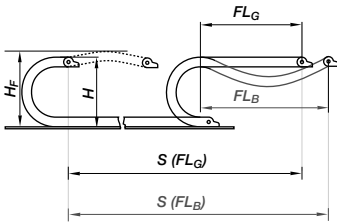

- S = Length of travel
- R = Bending radius
- H = Nominal clearance height
- H_F = Required clearance height
- H_{RI} = Trough inner height
- D = Overlength E-Chain® radius in final position
- $K = \pi \cdot R$ + "safety"
- D_2 = Over length - long travels, gliding
- K_2 = "Further add-on"
- H_2 = "Mounting height"

*if the mounting bracket location is set lower

Other installation methods

- Vertical, hanging ≤ 100 m
- Vertical, standing ≤ 6 m
- Side mounted, un supp. $\leq 2,5$ m
- Rotary requires further calculation
- Unsupported length of upper run = upon request

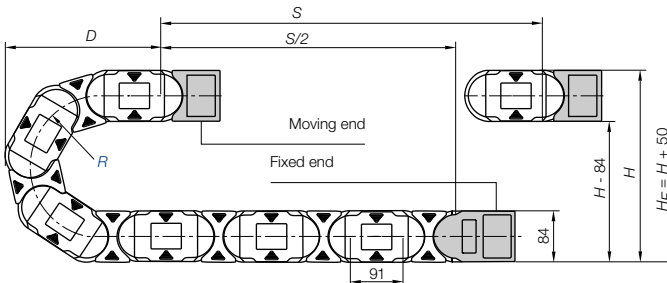

Pitch = 91 mm/link Links/m = 11 (1001 mm) Chain length = $S/2 + K$

R	135	150	175	200	240	250	300	350	400	450	500
H_{25}	354	384	434	484	564	584	684	784	884	984	1084
D	268	283	308	333	373	383	433	483	533	583	633
K	610	655	735	815	940	970	1125	1285	1440	1600	1755
H_2	354	266	266	266	266	266	266	266	266	266	266
D_2^{+25}	268	450	580	710	900	980	1180	1440	1530	1700	1850
K_2	610	819	1092	1274	1547	1638	2002	2275	2548	2912	3276



Short travels - unsupported

Unsupported E-Chains® feature positive camber over short travels. This must be accounted for when specifying the clearance height H_F . Please consult igus® if space is particularly restricted.

The required clearance height:
 $H_F = H + 50$ mm
(with 3,0 kg/m fill weight)

Long travel lengths from 10 m to max. 400 m Chain length = $S/2 + K_2$

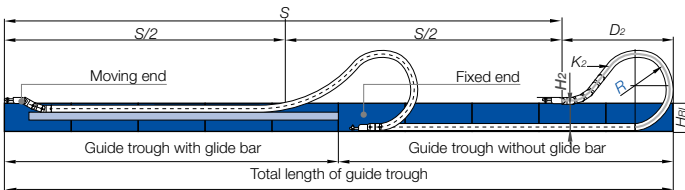

In case of travels between 4 and 10 m we recommend a longer unsupported length.



Gliding, long travel applications (max. 400 m)

In this case the E-Chain® upper run will be introduced in a guide trough on the lower run. We recommend to realize the engineering of such a plant by our technicians.

Technical Data

Speed / acceleration FL_G	max. 20 [m/s] / max. 200 [m/s ²]
Speed / acceleration FL_B	max. 3 [m/s] / max. 6 [m/s ²]
Gliding speed / acceleration (maximum)	max. 10 [m/s] / max. 50 [m/s ²]
Material - permitted temperature °C	igumid G / -40° up to +120° C
Flammability class, igumid G	VDE 0304 IIC UL94 HB



Details of material properties

► page 1.38

For support of the lower run - **Support Tray tool kit** available ► page 9.70

56

System E4.1
Inner height: 56 mm

Phone +49- (0) 22 03-96 49-800
Fax +49- (0) 22 03-96 49-222



► page 7.15

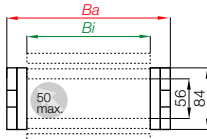

Part No. structure

E4.56. 13. 250. 0



Series E4.56 - E-Chain® with crossbars every link

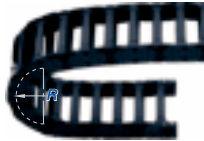

- Crossbars every link
- For rigid hydraulic hoses
- For applications particularly demanding
- Can be opened from two sides

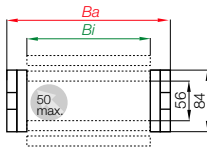

Part No. structure

H4.56. 13. 250. 0



Series H4.56 - E-Chain® with crossbars every 2nd link

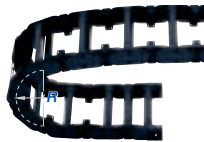

- Crossbars every 2nd link = Standard
- For nearly every situation
- Can be opened from two sides
- Easy assembly
- Stable
- Attractive price

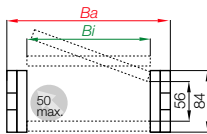

Part No. structure

R4.56. 25. 250. 0



Series R4.56 - Fully enclosed E-Tube



- Fully enclosed
- Excellent cable protection against dirt
- Protection against hot chips
- Lids along the entire inner radius are completely removable. Lids along the entire outer radius are single sided snap-open with a hinge on the other side to keep them attached to the chain or completely removable.



Part No.	<i>Bi</i>	<i>Ba</i>	E4.56	H4.56	R4.56	
	[mm]	[mm]	[kg/m]	[kg/m]	[kg/m]	
E4.56/H4.56.05.	0	50	84	3,301	3,158	-
E4.56/H4.56.06.	0	65	99	3,390	3,202	-
E4.56/H4.56/R4.56.07.	0*	75	109	3,458	3,236	3,910
E4.56/H4.56.08.	0	87	121	3,538	3,276	-
E4.56/H4.56/R4.56.10.	0	100	134	3,633	3,323	4,200
E4.56/H4.56.11.	0	112	147	3,749	3,382	-
E4.56/H4.56/R4.56.12.	0	125	159	3,827	3,420	4,560
E4.56/H4.56.13.	0	137	172	3,963	3,488	-
E4.56/H4.56/R4.56.15.	0	150	184	4,000	3,507	4,940
E4.56/H4.56.16.	0	162	197	4,113	3,563	-
E4.56/H4.56.17.	0	175	209	4,245	3,630	-
E4.56/H4.56.18.	0	187	222	4,357	3,685	-
E4.56/H4.56/R4.56.20.	0	200	234	4,413	3,713	5,560
E4.56/H4.56.21.	0	212	247	4,484	3,749	-
E4.56/H4.56.22.	0	225	259	4,553	3,784	-
E4.56/H4.56.23.	0	237	272	4,663	3,838	-
E4.56/H4.56/R4.56.25.	0	250	284	4,774	3,894	6,290
E4.56/H4.56.26.	0	262	297	4,865	3,939	-
E4.56/H4.56/R4.56.27.	0	275	309	4,967	3,990	6,650
E4.56/H4.56.28.	0	287	322	5,025	4,019	-
E4.56/H4.56/R4.56.30.	0	300	334	5,177	4,095	6,950
E4.56/H4.56.31.	0	312	347	5,214	4,114	-
E4.56/H4.56.32.	0	325	359	5,317	4,166	-
E4.56/H4.56.33.	0	337	372	5,437	4,225	-
E4.56/H4.56/R4.56.35.	0	350	384	5,639	4,326	7,650
E4.56/H4.56.36.	0	362	397	5,549	4,282	-
E4.56/H4.56.37.	0	375	409	5,646	4,330	-
E4.56/H4.56.38.	0	387	422	5,762	4,388	-
E4.56/H4.56/R4.56.40.	0	400	434	6,031	4,523	8,650
E4.56/H4.56.41.	0	412	447	5,955	4,484	-
E4.56/H4.56.42.	0	425	459	6,247	4,630	-
E4.56/H4.56.43.	0	437	472	6,090	4,552	-
E4.56/H4.56.45.	0	450	484	6,420	4,717	-
E4.56/H4.56/R4.56.46.	0	462	497	6,372	4,693	9,118
E4.56/H4.56.47.	0	475	509	6,412	4,713	-
E4.56/H4.56.48.	0	487	522	6,658	4,836	-
E4.56/H4.56.50.	0	500	534	6,755	4,885	-
E4.56/H4.56.51.	0	512	547	6,668	4,841	-
E4.56/H4.56.52.	0	525	559	6,842	4,928	-
E4.56/H4.56.53.	0	537	572	6,934	4,974	-
E4.56/H4.56.55.	0	550	584	7,355	5,184	-
E4.56/H4.56.60.	0	600	634	7,584	5,299	-



Order-key for further options and versions for this series ► page 7.74

System E4.1
Inner height: 56 mm

Phone +49- (0) 22 03-96 49-800
Fax +49- (0) 22 03-96 49-222

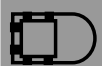

► page 7.15

Available bending radii

R [mm] **135**** 150 175 200 240 250 300 350 400 450 500

Supplement Part No. with required radius. Example: E4.56.30.**300**.0

0 = standard color, other colors ► page 1.39 · Pitch: 91 mm/link - Links/m = 11

* Removable lid only, no hinged option

** not available for R4.56



Extender crossbar for large diameter hoses ► page 7.70

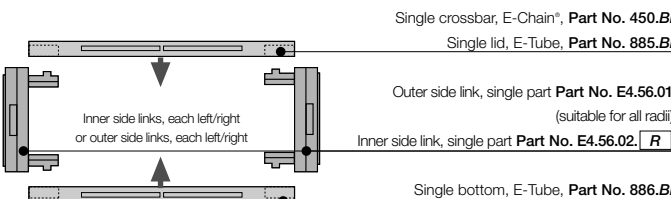

Part No. E-Chain® links, single parts

Inner side link
Outer side link



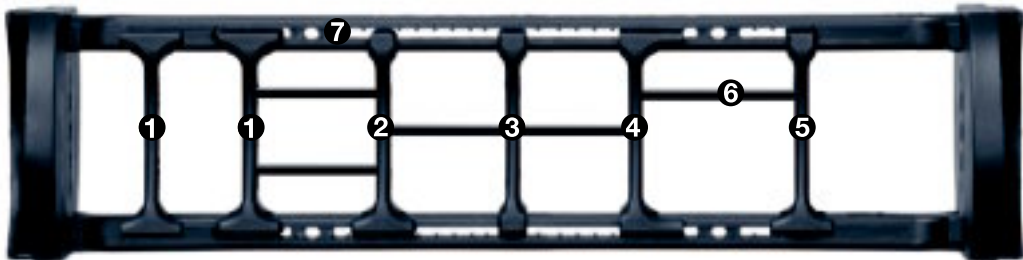

Optimized and extended interior separation range for Series E4.56. Wear optimized geometry with a high locking strength. The very cable friendly design increases your cables cycle life even further. Universally suitable for E-Chains® and E-Tubes, 3x slotted!

Phone +49- (0) 22 03-96 49-800
Fax +49- (0) 22 03-96 49-222

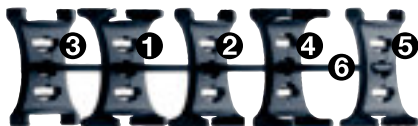

- ① Standard Separator, wide foot - Part. No. 56.1
- ② Separator for QuickLock crossbar - Part. No. 56.2
- ③ Narrow separator - Part. No. 56.3
- ④ Asymmetric separator - Part. No. 56.4
- ⑤ Notch separator - Part. No. 56.5

Realize a better separation with fewer, standardized parts

- Optimized and extended interior separation range
- The very cable friendly design increases your cables cycle life even further
- Same separation for E-Chains® and E-Tubes
- Safe force closure connection
- Cable friendly plastic crossbars, optimized for low cable wear and long cycle life
- Faster and easier assembly

igus® GmbH
51147 Cologne



⑥ Functionality - full-width shelf, lockable - Part. No. 520.XX

⑥ For horizontal separation: full-width shelf

- Shelf locks safely into separators on both ends through special locking clip
- Separators can be moved freely over the shelf in horizontal direction
- No side plates necessary
- Partial horizontal shelving possible



⑦ Standard* for all E4 crossbars and lids/bottoms: lock-in and scaling

*First few sizes available. Completion of the product range by the end of 2009

⑦ Notch crossbars, notch bottoms and lids

- No additional spacers necessary for side-mounted applications
- High locking strength of the separator in lock-in position
- Clearly visible, plane scaling
- Clearly notches and scaling on crossbars for E-Chains® and bottoms and lids of E-Tubes

Internet: www.igus.eu
E-mail: info@igus.de

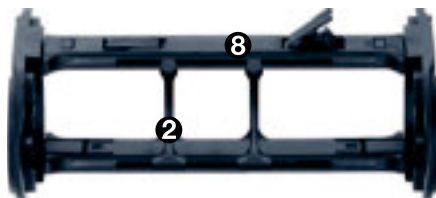

⑧ QuickLock crossbar, single part - Part No. 450.X.Q
(X = Inner width Bi E-Chains® / Q = QuickLock)

⑧ Optimized QuickLock crossbar

- One-click opening of the QuickLock crossbar = 25 % faster assembly compared to standard crossbars
 - Quick assembly/disassembly
 - Faster assembly with less effort
 - Free access to the top, E-Chain® can remain in the guide trough
- www.igus.de/en/E4schnelleMontage

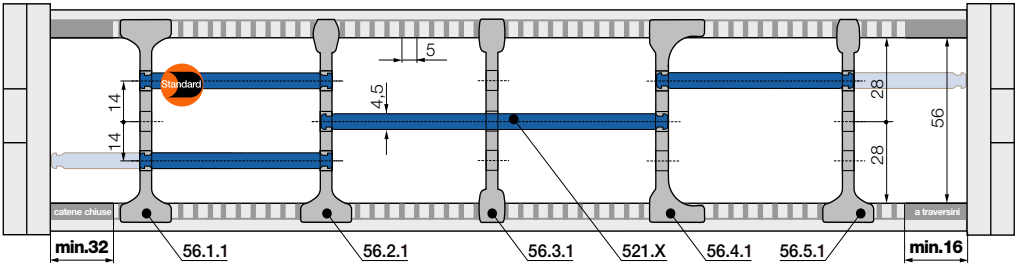

In the standard configuration, a separator is mounted at every second chain link!

Note: Observe a lateral spacing of at least 32 mm (E-Tube) and 16 mm (E-Chain®)!

Standard - for all applications

① Separator with wide foot for maximum locking strength and safe standing in E-Chains® and E-Tubes

For even faster installation

② Separator for igus® ③ QuickLock crossbar 450.X.Q. Firm hold to one side with a wide foot, narrow on opposed side for easy cable assembly (slight grip)

For many thin cables

④ Separator with narrow feet for a large number of thin cables side by side. Saves space in E-Chains® and E-Tubes.

Fore side-mounted applications

⑤ Asymmetrical separator, for defined distance. No additional spacers necessary for E-Chains® and E-Tubes

Locks safely onto in 5 mm increments

⑥ Notch separator for ⑦ the new notch crossbar. With scaling on the notch crossbars. For exact positioning in E-Chains® and E-Tubes

Horizontal separation

⑧ Full-width shelf (Inner widths 50 - 450 mm). Shelf locks safely into separators on both ends, fixed width possible. Separators can be moved freely over the shelf in horizontal direction. Usable in 3 levels.

	Standard separator, wide foot	
	unassembled 56.1	
	assembled 56.1.1	
	Separator for QuickLock crossbar	
	unassembled 56.2	
	assembled 56.2.1	
	Separator, narrow foot	
	unassembled 56.3	
	assembled 56.3.1	
	Asymmetrical separator	
	unassembled 56.4	
	assembled 56.4.1	
	Notch separator	
	unassembled 56.5	
	assembled 56.5.1	
	Full-width shelf, lockable	
	unassembled 520.X	
	assembled 521.X	
	XX = Width - see table below!	

Width X [mm]	Part No.		Width X [mm]	Part No.	
	unassembled	assembled		unassembled	assembled
050	520.050	521.050	175	520.175	521.175
062	520.062	521.062	200	520.200	521.200
075	520.075	521.075	225	520.225	521.225
100	520.100	521.100	250	520.250	521.250
125	520.125	521.125	300	520.300	521.300
150	520.150	521.150	450	520.450	521.450

Phone +49- (0) 22 03-96 49-800
Fax +49- (0) 22 03-96 49-222

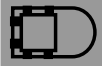



Standard_02 - Proven and tested interior separation elements for special and extremely variable partitioning! For use with many cables of differing diameters. E-Chains® and E-Tubes can be subdivided both vertically and horizontally.

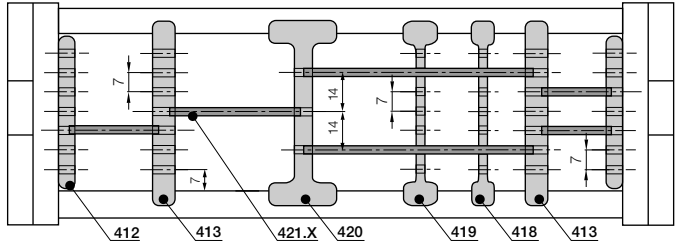

Split separator T563, to be split for shelf 420.X

Split separator for E-Chains®	
unassembled	T563
assembled	T563M



More proven interior separation elements

- **Split separator T563** - ideal for subsequent shelving or for the initial assembly of the E-Chain®. Fast assembly and disassembly possible through hinge/push mechanism. Saves assembly time. Enhances flexibility. (For Shelf 420.X).



Side plate 402

Seitenplatte/Side plate for E-Chains®/E-Tubes	
unassembled	402
assembled	412



- **Side plates 402, middle plates 403 and Shelves 420.X** form the basic pattern of a shelf system. Shelves of various widths can be arranged at 7 different heights (in 7 mm increments).



Middle plate 403

Middle plate for E-Chains®/E-Tubes	
unassembled	403
assembled	413



- **Locking vertical separator 410**, slotted combined with shelves (only for E-Chains®).



Locking vertical separator 410

Locking vertical separator for E-Chains®	
unassembled	410
assembled	420



- **Slotted separators 408**, are used for very fine subdivisions. However, they cannot be retrofitted into an existing separation system without dismantling the interior separators first.



Slotted separator 408

Slotted separator for E-Chains®/E-Tubes	
unassembled	408
assembled	418



- The unilateral **open slotted separator 409** can be retrofitted into an existing interior separation system without a need for dismantling the interior separators. During an installation of open slotted separators, the top and bottom notches cannot be occupied by shelves.



Open slotted separator 409

Open slotted separator for E-Chains®/E-Tubes	
unassembled	409
assembled	419



Shelf 420.X

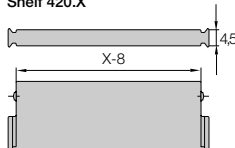

Width X [mm]	Part No. unassembled	Part No. assembled
018	420.18	421.18
023	420.23	421.23
025	420.25	421.25
028	420.28	421.28
033	420.33	421.33
043	420.43	421.43
050	420.50	421.50
062	420.62	421.62

Width X [mm]	Part No. unassembled	Part No. assembled
075	420.75	421.75
088	420.88	421.88
100	420.100	421.100
125	420.125	421.125
150	420.150	421.150
175	420.175	421.175
187	420.187	421.187
200	420.200	421.200

For new constructions, we recommend the new igus® interior separation kit
Previous interior separation - will continue to be available!



E4.56
H4.56
R4.56

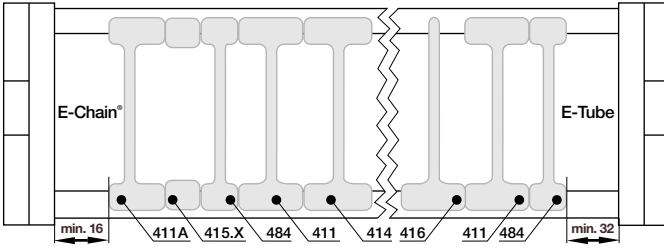

Vertical separators are used if a vertical subdivision is required. In the standard configuration, a separator is mounted at every second E-Chain® link. **Note:** Observe a lateral spacing of at least 32 mm (E-Tube) and 16 mm (E-Chain)! (Exception: No minimum spacing for side plates)

Vertical separators and spacers

● Standard separator 401 for E-Chains®/E-Tubes offers safe stability due to its broad foot design, also when used with thick cables or hoses.

● Vertical separator 483 with a narrow foot for E-Chains® and E-Tubes with applications where a large number of small cables need to be individually separated.

● Separators (e.g. "side mounted") for E-Chains® can be fixed in their position with Spacers 405.XX. The available inner height will be reduced by 2 mm, per spacer and side. To avoid this, the parts can be assembled on outside of the crossbar (not for long travels) XX = width of the spacer (available 10, 15, 20, 30 and 40 mm)

● Locking separator for E-Chains® 404 - with increased retention force for applications exposed to very high humidity or extreme loads. The extra retention force is achieved by asymmetric claws for the crossbar. Ensure proper alignment

● Locking separator 406 for E4-Tubes - safe fitting locked on lid or bottom of the Tube and sideways slideable. The opposing lid or bottom can easily be opened and closed. Especially capable if many separators need to be assembled on a tight inner width

● Asymmetric separator 401A for E-Chains® with an 18-mm base, for combinations between spacers of different widths and vertical separators in side-mounted applications, for instance.



Vertical separator for E-Chains®/E-Tubes	
unassembled	401
assembled	411

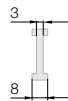

Vertical separator for E-Chains®/E-Tubes	
unassembled	483
assembled	484



Spacer* for E-Chains®	
unassembled	405.XX
assembled	415.XX



Locking separator for E-Chains®	
unassembled	404
assembled	414



Vertical separator for E-Tubes	
unassembled	406
assembled	416



Asymmetric separator for E-Chains®	
unassembled	401A
assembled	411A

*For side-mounted applications



Vertical separator 401



Vertical separator 483



Spacer 405.XX



Locking separator 404



Vertical separator 406



Asymmetric separator 401A

Additional elements for interior separation

Center crossbar	
unassembled	405
assembled	415

Center crossbar - for applications with a large number of thin cables. The center crossbar offers the option of subdividing the E-Chain® independently into upper and lower halves.

Rollclip	
unassembled	489.27
assembled	490.27

Rollclip - minimizes abrasion of particularly sensitive hoses - simply clamped onto the opening crossbar. The movable rollers compensate for relative movement between the chain and hose.

Roller separator	
unassembled	429
assembled	430

Roller separator - performs a similar function to the Rollclip, but doubles as a separator.

System E4.1
Inner height: 56 mm

Phone +49- (0) 22 03-96 49-800
Fax +49- (0) 22 03-96 49-222

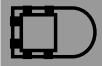



Part No. structure

E4.56.10 /20 /10. 200 .0

E4.56.Bi1/Bi2/Bi3. R .0

Extension links - for extremely wide E-Chains® up to 3 m

- For applications in which particularly high fill weights necessitate extremely wide E-Chains® (up to 3000 mm)
- The extension link design allows virtually limitless side-by-side attachment of chains
- The unsupported length of a chain can be increased when additional loads are required
- Extension links can be used with E-Chains®, E-Tubes or as a combination of both
- They are suitable for unsupported and gliding applications in a guide trough
- E-Chains® with extension links are attached with KMA or steel mounting brackets

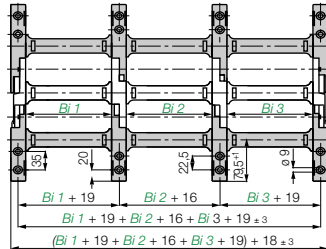

Consult igus® for your extender crossbar applications. We are happy to assist you with your design layout

Extender crossbars - careful guide of hoses applications

- Suitable for hoses with a maximum outer diameter of 245 mm
- Gliding operation with crossbars assembled along the outer radius and a special guide trough
- Gliding operation not guaranteed with crossbars assembled along the inner radius
- The extender crossbar can either be attached to the side links directly or can be used in combination with two stranded snap-open crossbars

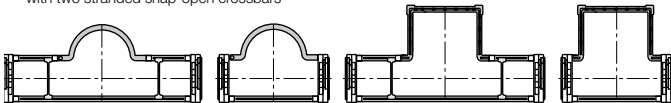

Round extender crossbar combined with snap-open crossbars

Attached directly to the side link

Square extender crossbar with snap-open crossbars

Attached directly to the side link

Part No.	Max Ø [mm] hose	Form	Installation side link	Combination with snap-open crossb.
450.15.RHD115	115	○	-	+
450.17.RD115	115	○	+	-
450.25.D150	150	□	+	-
450.30.D200	180	□	+	-
450.35.D250	195	□	+	-
450.40.D300	245	□	+	-
450.20.HD150	150	□	-	+
450.25.HD200	180	□	-	+
450.30.HD250	195	□	-	+

○ = round □ = square + = yes / - = no



E4 clip-on cable binder

- For side-mounted applications
- Serves as a clip-on, lateral guide for hoses and cables on E-Chains®
- The loops can be adjusted as required
- Compatible with many E4 E-Chains®
- Stylish and economical
- One clip and one locking band are needed for each chain link
- Call us if you have any questions on project planning

Part No.	Form
450.B12	Locking clip, comprising a locking element
450.B12.200	Locking band, comprising a locking element and band; 12 x 1,5 x 200 mm

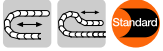

The Standard - Option KMA* - pivoting

- Recommended for unsupported and gliding applications
- Universal mountable with attachment capability on all sides
- Bolted connection outside of chain cross-section
- Confined installation conditions
- Corrosion resistant

*KMA = Polymer Metal Mounting Bracket

Moving end

E4.560/R4.560....2

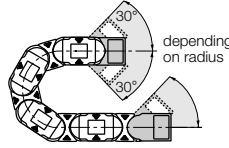

Fixed end

E4.560/R4.560....1



The attachment variants arising automatically by the choice of the KMA mounting bracket

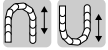
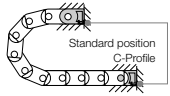

Option KMA - locking

- Recommended for vertical hanging / standing applications

Additionally:

- Universal mountable
- C-profile option
- Corrosion resistant
- Locked connections
- At very high acceleration

Moving end

E4.561/R4.561....2

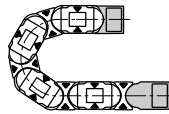

Fixed end

E4.561/R4.561....1



The attachment variants arising automatically by the choice of the KMA mounting bracket

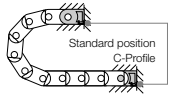

Fixed end

E4.560/R4.560....1 (pivoting)
E4.561/R4.561....1 (locking)

Moving end

(pivoting) E4.560/R4.560....2
(locking) E4.561/R4.561....2

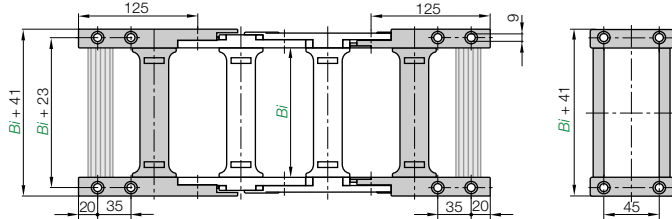

Dimensions and order configurations

Part No. structure (pivoting)

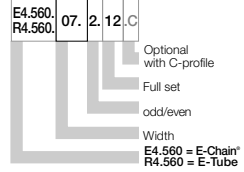

Part No. structure (locking)

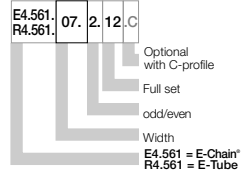

Note: The E4.1 System may end with either an inner side or an outer side link. Keep in mind that an outer side link always forms the first chain link at the moving end. The Part No. depend on an even or odd numbers of links. Please insert: for odd number of links or for even number of links

Full set, for both ends:

E4.560.] 07.] 2.] .2] C] (even)

Single-part order:

E4.560.] 07.] 2.] .2] C] (even)

Mounting bracket moving end

E4.560.] 07.] 2.] .1] C] (even)

Mounting bracket fixed end

Width index	Part No. full set		Bi [mm]	Width index	Part No. full set		Bi [mm]
	pivoting	locking			pivoting	locking	
.05.	E4.560	E4.561	.05.] <input type="checkbox"/> .12.] C] 50	.31.	E4.560	E4.561	.31.] <input type="checkbox"/> .12.] C] 312
.06.	E4.560	E4.561	.06.] <input type="checkbox"/> .12.] C] 65	.32.	E4.560	E4.561	.32.] <input type="checkbox"/> .12.] C] 325
.07.	E4./R4.560	E4./R4.561	.07.] <input type="checkbox"/> .12.] C] 75	.33.	E4.560	E4.561	.33.] <input type="checkbox"/> .12.] C] 337
.08.	E4.560	E4.561	.08.] <input type="checkbox"/> .12.] C] 87	.35.	E4./R4.560	E4./R4.561	.35.] <input type="checkbox"/> .12.] C] 350
.10.	E4./R4.560	E4./R4.561	.10.] <input type="checkbox"/> .12.] C] 100	.36.	E4.560	E4.561	.36.] <input type="checkbox"/> .12.] C] 362
.11.	E4.560	E4.561	.11.] <input type="checkbox"/> .12.] C] 112	.37.	E4.560	E4.561	.37.] <input type="checkbox"/> .12.] C] 375
.12.	E4./R4.560	E4./R4.561	.12.] <input type="checkbox"/> .12.] C] 125	.38.	E4.560	E4.561	.38.] <input type="checkbox"/> .12.] C] 387
.13.	E4.560	E4.561	.13.] <input type="checkbox"/> .12.] C] 137	.40.	E4./R4.560	E4./R4.561	.40.] <input type="checkbox"/> .12.] C] 400
.15.	E4./R4.560	E4./R4.561	.15.] <input type="checkbox"/> .12.] C] 150	.41.	E4.560	E4.561	.41.] <input type="checkbox"/> .12.] C] 412
.16.	E4.560	E4.561	.16.] <input type="checkbox"/> .12.] C] 162	.42.	E4.560	E4.561	.42.] <input type="checkbox"/> .12.] C] 425
.17.	E4.560	E4.561	.17.] <input type="checkbox"/> .12.] C] 175	.43.	E4.560	E4.561	.43.] <input type="checkbox"/> .12.] C] 437
.18.	E4.560	E4.561	.18.] <input type="checkbox"/> .12.] C] 187	.45.	E4.560	E4.561	.45.] <input type="checkbox"/> .12.] C] 450
.20.	E4./R4.560	E4./R4.561	.20.] <input type="checkbox"/> .12.] C] 200	.46.	E4./R4.560	E4./R4.561	.46.] <input type="checkbox"/> .12.] C] 462
.21.	E4.560	E4.561	.21.] <input type="checkbox"/> .12.] C] 212	.47.	E4.560	E4.561	.47.] <input type="checkbox"/> .12.] C] 475
.22.	E4.560	E4.561	.22.] <input type="checkbox"/> .12.] C] 225	.48.	E4.560	E4.561	.48.] <input type="checkbox"/> .12.] C] 487
.23.	E4.560	E4.561	.23.] <input type="checkbox"/> .12.] C] 237	.50.	E4.560	E4.561	.50.] <input type="checkbox"/> .12.] C] 500
.25.	E4./R4.560	E4./R4.561	.25.] <input type="checkbox"/> .12.] C] 250	.51.	E4.560	E4.561	.51.] <input type="checkbox"/> .12.] C] 512
.26.	E4.560	E4.561	.26.] <input type="checkbox"/> .12.] C] 262	.52.	E4.560	E4.561	.52.] <input type="checkbox"/> .12.] C] 525
.27.	E4./R4.560	E4./R4.561	.27.] <input type="checkbox"/> .12.] C] 275	.53.	E4.560	E4.561	.53.] <input type="checkbox"/> .12.] C] 537
.28.	E4.560	E4.561	.28.] <input type="checkbox"/> .12.] C] 287	.55.	E4.560	E4.561	.55.] <input type="checkbox"/> .12.] C] 550
.30.	E4./R4.560	E4./R4.561	.30.] <input type="checkbox"/> .12.] C] 300	.60.	E4.560	E4.561	.60.] <input type="checkbox"/> .12.] C] 600

Please insert for odd number of links or for even number of links

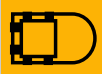



Chainfix steel clamps and Chainfix stainless-steel clamps - max. pull forces, adjustable with hexagon socket. Available as single, double or triple clamps

Chainfix clamps for the C-profile

Part No. single clamps		Part No. double clamps		Part No. triple clamps		Cable
steel	stainless steel	steel	stainless steel	steel	stainless steel	ø [mm]
CFX12.1	CFX12.1.E	CFX12.2	CFX12.2.E	CFX12.3	-	06 - 12
CFX14.1	CFX14.1.E	CFX14.2	CFX14.2.E	CFX14.3	-	12 - 14
CFX16.1	CFX16.1.E	CFX16.2	CFX16.2.E	CFX16.3	-	14 - 16
CFX18.1	CFX18.1.E	CFX18.2	CFX18.2.E	CFX18.3	-	16 - 18
CFX20.1	CFX20.1.E	CFX20.2	CFX20.2.E	CFX20.3	-	18 - 20
CFX22.1	CFX22.1.E	CFX22.2	CFX22.2.E	CFX22.3	-	20 - 22
CFX26.1	CFX26.1.E	CFX26.2	CFX26.2.E	-	-	22 - 26
CFX30.1	CFX30.1.E	CFX30.2	CFX30.2.E	-	-	26 - 30
CFX34.1	CFX34.1.E	CFX34.2	CFX34.2.E	-	-	30 - 34
CFX38.1	CFX38.1.E	-	-	-	-	34 - 38
CFX42.1	CFX42.1.E	-	-	-	-	38 - 42



Chainfix Clip - Modular snap-on strain relief device for C-profile

Available for all igus® E-ChainSystems® with C-profiles and also suitable for assembly in the KMA mounting brackets and Clip-on strain relief for crossbars. High pull forces, plug-in modular snap-on strain relief device. **Details ▶ chapter 10**

Cable ø [mm]	Part No. clamp	Part No. bottom part
04 - 08	CFC-08-M	CFC-08-C
08 - 12	CFC-12-M	CFC-12-C
12 - 16	CFC-16-M	CFC-16-C
16 - 20	CFC-20-M	CFC-20-C
20 - 24	CFC-24-M	CFC-24-C



Chainfix Nugget for the C-Profile

Strain relief for the fixation of cables up to a diameter of Ø 30 mm. Easy to assemble, without any screws and tools. Easy strain relief due to fixation with pre-harnessed cable strap, very small space requirement. **Details ▶ chapter 10**

Part No.	ø max. conduit [mm]	Width [mm]
CFN.20	20	10,8
CFN.30.52	30	16,8
CFN.20.N35	20	20,0

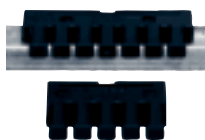

Chainfix tiwrap plates with clip-on connection for the C-profile

Can be plugged into the KMA C-profile. Easy to assemble without any screws. Easily solvable with screwdriver nevertheless safe stop. For all E-Chains® with KMA and integrated C-profile. **Details ▶ chapter 10**

Part No.	Width of strain relief [mm]	Number of teeth
3050.ZC	50	5
3075.ZC	75	7

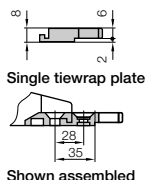

Chainfix tiwrap plate as individual part

As individual component screwed on KMA, can also be plugged into the mounting bracket. **Details ▶ chapter 10**

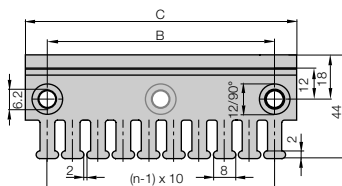

Tiwrap plate	No. of teeth n	Dim. C [mm]	Dim. B [mm]	Center bore
3050.ZB	5	50	30	-
3075.ZB	7	75	55	-
3100.ZB	10	100	80	-
3115.ZB	11	115	95	-
3125.ZB	12	125	105	-
3150.ZB	15	150	130	-
3175.ZB	17	175	155	-
3200.ZB	20	200	180	+
3225.ZB	22	225	205	+
3250.ZB	25	250	230	+

(- = no / + = yes)

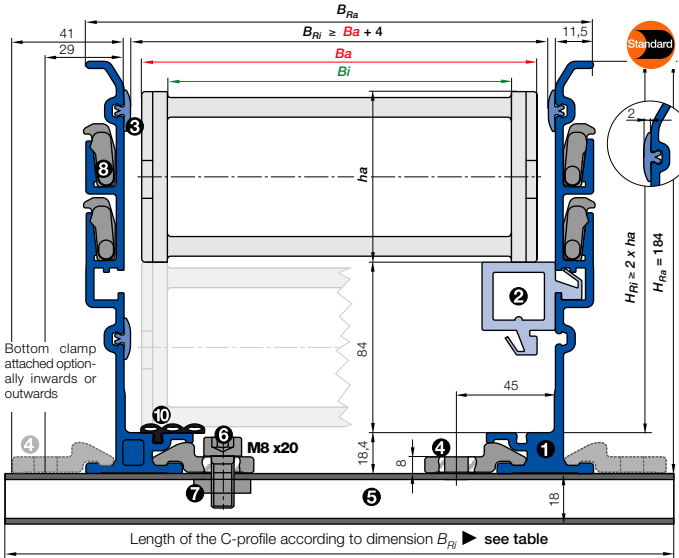

- Ba** = Outer width E-Chains* / E-Tube
- Bi** = Inner width E-Chains* / E-Tube
- ha** = Outer height E-Chains* / E-Tube
- H_{Ri}** = Inner trough height
- H_{Ra}** = Outer trough height
- B_{Ri}** = Inner trough width ▶ depends on dim. Ba
- B_{Ra}** = Outer trough width
- n_{Mon}** = Number of installation sets (left/right)
- n_{Ri}** = Number of trough sets (left/right)
- H_{Ri} ≥ 2 • ha**
- B_{Ri} ≥ Ba + 4**
- = Guide trough set ● = Glide bar
- = Installation set "Basic" ● = C-Profile

Installation set "Basic" with C-Profile

Bottom Clamp attached optionally inwards or outwards

E4.56.05.200.0 ▶ Order example

B _{Ri} [mm]	Part No.	
	attached inwards	attached outwards
.05	88	-
.06	103	-
.07	113	-
.08	125	960.50.175
.10	138	960.50.200
.11	151	960.50.225
.12	163	960.50.225
.13	176	960.50.225
.15	188	960.50.250
.16	201	960.50.250
.17	213	960.50.275
.18	226	960.50.275
.20	238	960.50.300
.21	251	960.50.300
.22	263	960.50.325
.23	276	960.50.325
.25	288	960.50.350
.26	301	960.50.350
.27	313	960.50.375
.28	326	960.50.375
.30	338	960.50.400
.31	351	960.50.400
.32	363	960.50.425
.33	376	960.50.425
.35	388	960.50.450
.36	401	960.50.450
.37	413	960.50.475
.38	426	960.50.475
.40	438	960.50.500
.41	451	960.50.500
.42	463	960.50.525
.43	476	960.50.525
.45	488	960.50.550
.46	501	960.50.550
.47	513	960.50.575
.48	526	960.50.575
.50	538	960.50.600
.51	551	960.50.600
.52	563	960.50.625
.53	576	960.50.625
.55	588	960.50.650
.60	638	960.50.700



- **Components, trough "Basic":** ① Trough side parts, aluminum, 2 m ② Glide bar, plastic, 2 m ③ Glide strips, plastic, 2 m (without glide strips on request) ⑩ Optional: Silencer profile, rubber
- **Components, installation set "Basic":** ④ Bottom clamp, aluminum ⑤ C-profile, steel galvanized ⑥ Screw M8 x20 ⑦ Sliding nut M8 ⑧ Interface connector, plastic

Order example: Length of travel 30 m - Center mounted for Series E4.56.10.200.0 with B_{Ri} = 138

- Guide trough set (set of 2 trough side parts, incl. glide strips) **without** glide bar
Order text: 16 m guide trough without glide bar (8 x 2 m sections) Part No. **974.30.SL**
- Guide trough set (set of 2 trough side parts, incl. glide strips) **with** glide bar
Order text: 16 m guide trough with glide bar (8 x 2 m sections) Part No. **974.31.SL**
- Installation set "Basic" complete (guide trough-sets + 1)
Order text: 17 installation sets "Basic" Part No. **960.50.200**
- Module for the fixed end
Order text: 1 set Part No. **974.80**
- Option:** For an additional noise dampening with dampening profile, please add Index A Example: Part No. **974.30.SLA**

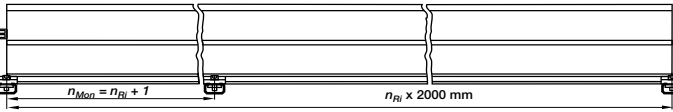

Principle sketch: Number of installation sets to be installed = **Number of trough sections + 1**

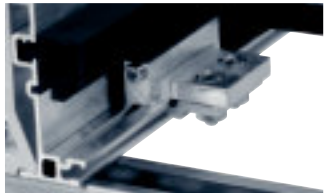

A quick fix for mounting the stationary end of an E-Chain®
 With this module for the fixed end, fast and easy mounting onto the Aluminum "SuperTrough" is now possible without any drilling. Fast mounting of the E-Chain® by clamping onto the aluminum trough
 ● Quick relocation of the stationary end ● No drilling necessary ▶ [page 9.16](#)

Insert for the installation set "Heavy-Duty": **974.50.XXX** instead of **(960.50.XXX)** on the right column "attached outwards"

Phone +49- (0) 22 03-96 49-800
 Fax +49- (0) 22 03-96 49-222

▶ chapter 10

▶ chapter 9

▶ page 7.15

Standard

 Part. No.
Standard
 E-Chains®/E-Tubes

E4.56.30.R.0

(Crossbar every link)

H4.56.30.R.0

 (Crossbar every 2nd link)

R4.56.30.R.0

(E-Tube, closed)

Delivery time
 24h or today

 Additional noise
 dampening
 with pads

 Part. No.
Low noise (with pads)
 E-Chains®/E-Tubes

ES4.56.30.R.0

(Crossbar every link)

HS4.56.30.R.0

 (Crossbar every 2nd link)

RS4.56.30.R.0

(E-Tube, closed)

Delivery time
 3-5 workdays

 QuickLock crossbar -
 save up to 25%
 assembly time

 Part. No.
QuickLock crossbar*
 for inner radius

E4.56.30.QZ.R.0

(Crossbar every link)

H4.56.30.QZ.R.0

 (Crossbar every 2nd link)

R4.56.30.QZ.R.0**

(E-Tube, closed)

Delivery time
 3-5 workdays

 Part. No.
QuickLock crossbar*
 for Outer radius

QuickLock crossbars: smallest inner width from B/ 15 (150 mm)!

E4.56.30.QE.R.0

(Crossbar every link)

H4.56.30.QE.R.0

 (Crossbar every 2nd link)

R4.56.30.QE.R.0**

(E-Tube, closed)

Delivery time
 3-5 workdays

 Part. No.
QuickLock crossbar*
 both sides

E4.56.30.Q.R.0

(Crossbar every link)

H4.56.30.Q.R.0

 (Crossbar every 2nd link)

R4.56.30.Q.R.0**

(E-Tube, closed)

Delivery time
 3-5 workdays

 * available from fall 2009
 ** upon request

 * available from fall 2009
 ** upon request

 * available from fall 2009
 ** upon request

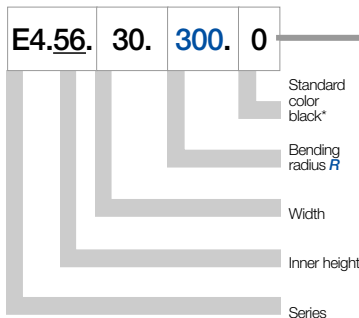
Order example - Standard

All E-Chains® made from igumid G are available in the colors listed in the table. Additional colors are usually feasible. (Standard color black). Colored E-Chains® are basically not available from stock.

Color options for igus® E-Chains® and E-Tubes. Standard color black (from stock)

E-Chains®/E-Tubes	igus® color index	Ral-numbers (approx.)	Delivery time
Material color			
black	Index .0	⇒ RAL 9004	from stock
white*	Index .1	⇒ RAL 9003	2-4 weeks
violet*	Index .5	⇒ RAL 4008	2-4 weeks
yellow*	Index .4	⇒ RAL 1018	2-4 weeks
orange*	Index .2	⇒ RAL 2003	2-4 weeks
red*	Index .6	⇒ RAL 3002	2-4 weeks
blue*	Index .8	⇒ RAL 5005	2-4 weeks
green*	Index .7	⇒ RAL 6011	2-4 weeks
grey*	Index .3 (E-Chains®)	⇒ RAL 7023	2-4 weeks
dusty grey*	Index .3 (E-Tubes)	⇒ RAL 7037	2-4 weeks
agate grey*	Index .11	⇒ RAL 7038	2-4 weeks
light grey*	Index .14	⇒ RAL 7035	2-4 weeks
black grey*	Index .13	⇒ RAL 7021	2-4 weeks
yellow/black*	Index .9	⇒	2-4 weeks

*Delivery Time and pricing for colored E-Chains® upon request!

Easy turning of the outer link without rework

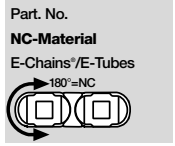

E4.56.30.R.0.NC
(Crossbar every link)

H4.56.30.R.0.NC
(Crossbar every 2nd link)

R4.56.30.R.0.NC
(E-Tube, closed)

Delivery time
24h or today

Reverse bending radius for circular movements

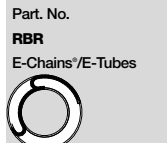

E4.56.30.R1/R2.0
(Crossbar every link)

H4.56.30.R1/R2.0
(Crossbar every 2nd link)

R4.56.30.R1/R2.0
(E-Tube, closed)

Delivery time
3-5 workdays

Unsupported lengths +25% possible

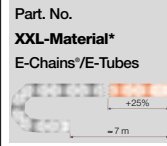

E4.56.30.R.0.XXL
(Crossbar every link)

H4.56.30.R.0.XXL
(Crossbar every 2nd link)

R4.56.30.R.0.XXL
(E-Tube, closed)

Delivery time
1-2 weeks

*Sidebands made from XXL-Material

No burning-in of hot chips up to 850°C (1562° F)

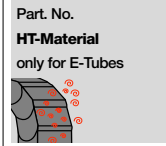

R4.56.30.R.0.HT
Complete E-Tube*

R4.56.30.HT.R.0
Lid and bottom

R4.56.30.HTZ.R.0
Bottom only

R4.56.30.HTE.R.0
Lid only

Delivery time
up to 4 weeks

for gliding applications please consult igus

ATEX/ESD classified E-Chains® - II 2 GD

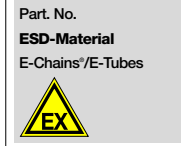

E4.56.30.R.0.ESD
(Crossbar every link)

H4.56.30.R.0.ESD
(Crossbar every 2nd link)

R4.56.30.R.0.ESD
(E-Tube, closed)

Delivery time
up to 2 weeks

Combination possibilities, examples:

	Low noise Option	QuickLock crossbar	NC-Version	RBR-Version	XXL-Material	HT-Material*	ESD-Material
Low noise Option		ES4.56.30Q.R.0	ES4.56.30.R.0.NC	-	ES4.56.30.R.0.XXL	RS4.56.30.R.0.HT	ES4.56.30.R.0.ESD
QuickLock crossbar	ES4.56.30Q.R.0		E4.56.30Q.R.0.NC	E4.56.30Q.R1/R2.0	E4.56.30Q.R.0.XXL	-	E4.56.30Q.R.0.ESD
NC-Version	ES4.56.30.R.0.NC	E4.56.30Q.R.0.NC		-	-	R4.56.30.R.0.HT.NC	E4.56.30.R.0.ESD.NC
RBR-Version	-	E4.56.30Q.R1/R2.0	-		-	R4.56.30.R1/R2.0.HT	E4.56.30.R1/R2.0.ESD
XXL-Material	ES4.56.30.R.0.XXL	E4.56.30Q.R.0.XXL	-	-		-	-
HT-Material*	RS4.56.30.R.0.HT	-	R4.56.30.R.0.HT.NC	R4.56.30.R1/R2.0.HT	-		-
ESD-Material	ES4.56.30.R.0.ESD	E4.56.30Q.R.0.ESD	E4.56.30.R.0.ESD.NC	E4.56.30.R1/R2.0.ESD	-	-	

for gliding applications please consult igus

Extreme glider with up to 70% larger gliding surfaces. For high additional loads and high surface speeds. Gliding applications without additional elements as well as 150% more wear allowance and enhancement of service life by factor 4! Order example: E4.56.35G.250.0 / E4.56.45G.250.0

Price index



Series E4.80 Series H4.80 Series R4.80



Low noise version
available with special
rubber pads design



Cleanroom test
upon request



ESD classification:
Electrically conductive ESD/ATEX
version upon request



Opening E-Chains: Remove crossbars and clips - Insert screwdriver into the slot, push down, release by lever action



Remove lids/bottoms (E-Tubes) - Insert screwdriver into the slot, release by lever action



When to use the Series E4.80/H4.80/R4.80:

- If a low-noise version is required
- At very high speeds and/or accelerations
- For long travels
- For high additional loads



When not to use it:

- When an extremely low vibration E-Chain® is required
- ▶ **Series E6.80, page 8.88**
- If the stability of a "light" version with thinner side parts is required due to cost- and space reasons
- ▶ **Series 15050/15150/R19850, page 7.144**

- 1 Straight run through inner-/outer-link design
- 2 Low-noise operation through integrated brake in the radial stop dog system
- 3 By the undercut design, very high stiffening and carrying capacity when shear forces are at work
- 4 15% more tensile strength (compared to the best old E4 series), better unsupported length through improved stop dog system and vertical radial stops
- 5 Crossbar available for faster assembly/disassembly - 450.X.Q
- 6 New Interior separation kit available
- 7 Version NC "without pretension" simply by turning outer links without rework possible
- 8 Crossbars are removable along both radii
- 9 Hinged snap-open removable lids along outer radius of E-Tube
- 10 Wide, rounded plastic crossbars - cable friendly

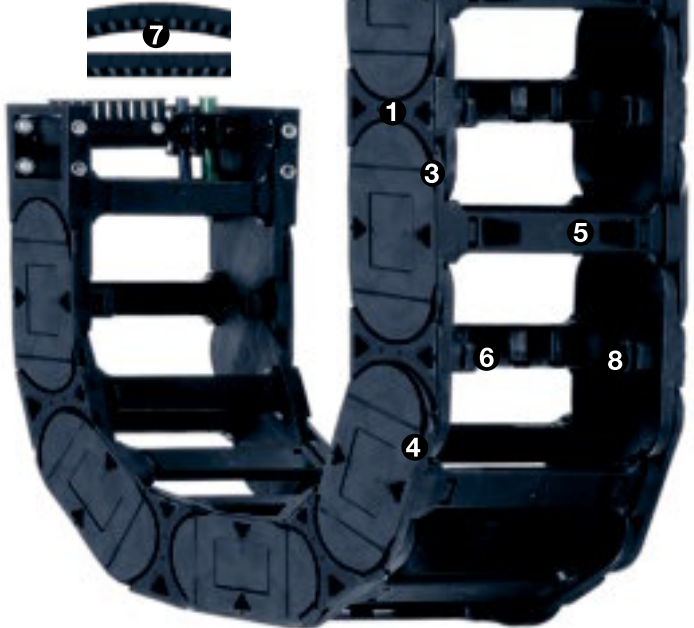

 **Order example complete E-Chain®**

Please indicate chain-lengths or number of links **Example: 5 m or 45 links**

5 m **E4.80.30.300.0**

 **E-Chain®**

with 2 separators **511** assembled every 2nd link

 **Interior separation**

1 set **E4.800.30.12.C**

 **Mounting bracket**



Unsupported length

FL_G = with straight upper run

FL_B = with permitted sag

Further information ► **Design, page 1.12**

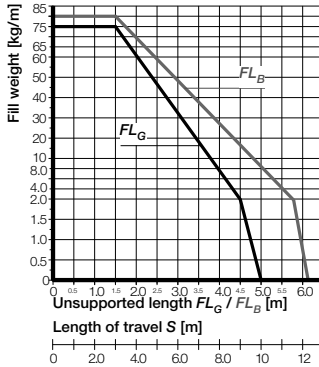
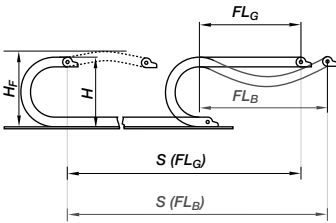

- S = Length of travel
- R = Bending radius
- H = Nominal clearance height
- H_F = Required clearance height
- H_{R1} = Trough inner height
- D = Overlength E-Chain® radius in final position
- $K = \pi \cdot R + \text{"safety"}$
- D_2 = Over length - long travels, gliding
- K_2 = *Further add-on
- H_2 = *Mounting height

Other installation methods

- Vertical, hanging ≤ 120 m
- Vertical, standing ≤ 6 m
- Side mounted, unsp. ≤ 3 m
- Rotary requires further calculation
- Unsupported length of upper run = upon request

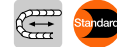

Short travels - unsupported

Unsupported E-Chains® feature positive camber over short travels. This must be accounted for when specifying the clearance height H_F . Please consult igus® if space is particularly restricted.

The required clearance height:

$H_F = H + 60$ mm
(with 3,0 kg/m fill weight)

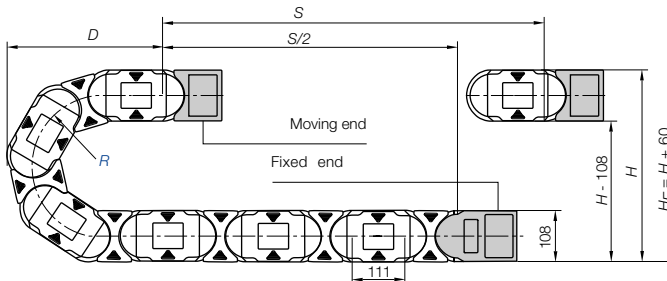

Pitch = 111 mm/link Links/m = 9 (999 mm) Chain length = $S/2 + K$

R	150	200	250	300	350	400	500	550	600	1000
H_{25}^0	408	508	608	708	808	908	1108	1208	1308	2108
D	315	365	415	465	515	565	665	715	765	1165
K	695	855	1010	1165	1325	1480	1795	1950	2110	3365
D_2^{+25}	550	800	1000	1200	1450	1600	2100	-	-	-
K_2	890	1330	1665	2000	2330	2660	3440	-	-	-
H_2	242	242	242	242	242	242	242	-	-	-

Long travel lengths from 10 m to max. 400 m Chain length = $S/2 + K_2$

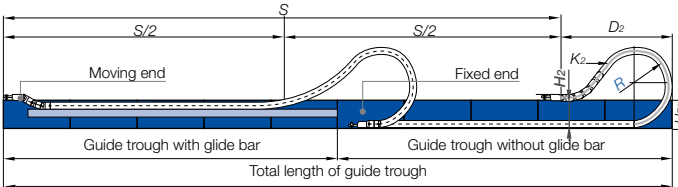

In case of travels between 4 and 10 m we recommend a longer unsupported length.



Gliding, long travel applications (max. 400 m)

In this case the E-Chain® upper run will be introduced in a guide trough on the lower run. We recommend to realize the engineering of such a plant by our technicians.

Technical Data

Speed / acceleration FL_G	max. 20 [m/s] / max. 200 [m/s²]
Speed / acceleration FL_B	max. 3 [m/s] / max. 6 [m/s²]
Gliding speed / acceleration (maximum)	max. 10 [m/s] / max. 50 [m/s²]
Material - permitted temperature °C	igumid G / -40° up to +120° C
Flammability class, igumid G	VDE 0304 IIC UL94 HB



Details of material properties
► page 1.38

For support of the lower run - **Support Tray tool kit** available ► page 9.70

System E4.1
Inner height: 80 mm

Phone +49- (0) 22 03-96 49-800
Fax +49- (0) 22 03-96 49-222



► page 7.15

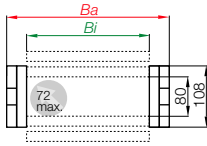

Part No. structure

E4.80. 30. 300. 0



Series E4.80 - E-Chain® with crossbars every link

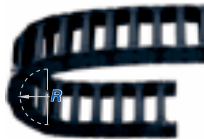

- Crossbars every link
- For rigid hydraulic hoses
- For applications particularly demanding
- Can be opened from two sides

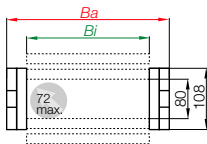

Part No. structure

H4.80. 30. 300. 0



Series H4.80 - E-Chain® with crossbars every 2nd link



- Crossbars every 2nd link = Standard
- For nearly every situation
- Can be opened from two sides
- Easy assembly
- Stable
- Attractive price

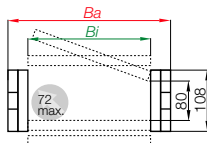

Part No. structure

R4.80. 25. 300. 0



Series R4.80 - Fully enclosed E-Tube



- Fully enclosed
- Excellent cable protection against dirt
- Protection against hot chips
- Lids along the entire inner radius are completely removable. Lids along the entire outer radius are single sided snap-open with a hinge on the other side to keep them attached to the chain or completely removable.



Part No.	<i>Bi</i>	<i>Ba</i>	E4.80	H4.80	R4.80
	[mm]	[mm]	[kg/m]	[kg/m]	[kg/m]
E4.80/H4.80.05.....	50	100	5,339	5,221	-
E4.80/H4.80.06.....	65	115	5,411	5,257	-
E4.80/H4.80.07.....	75	137	5,467	5,285	-
E4.80/H4.80.08.....	87	115	5,563	5,319	-
E4.80/H4.80.10.....	100	150	5,610	5,357	-
E4.80/H4.80.11.....	112	163	5,705	5,404	-
E4.80/H4.80.12.....	125	175	5,769	5,436	-
E4.80/H4.80.13.....	137	188	5,880	5,492	-
E4.80/H4.80.15.....	150	200	5,911	5,507	-
E4.80/H4.80.16.....	162	213	6,003	5,553	-
E4.80/H4.80.17.....	175	225	6,111	5,607	-
E4.80/H4.80.18.....	187	238	6,202	5,653	-
E4.80/H4.80/R4.80.20.....	200	250	6,248	5,676	≈7,230
E4.80/H4.80.21.....	212	263	6,306	5,705	-
E4.80/H4.80.22.....	225	275	6,363	5,733	-
E4.80/H4.80.23.....	237	288	6,453	5,778	-
E4.80/H4.80/R4.80.25.....	250	300	6,543	5,824	≈8,060
E4.80/H4.80.26.....	262	313	6,618	5,861	-
E4.80/H4.80.27.....	275	325	6,701	5,902	-
E4.80/H4.80.28.....	287	338	6,749	5,926	-
E4.80/H4.80/R4.80.30.....	300	350	6,873	5,988	≈8,730
E4.80/H4.80.31.....	312	363	6,904	6,004	-
E4.80/H4.80.32.....	325	375	6,988	6,046	-
E4.80/H4.80.33.....	337	388	7,086	6,095	-
E4.80/H4.80.35.....	350	400	7,251	6,177	-
E4.80/H4.80.36.....	362	413	7,178	6,141	-
E4.80/H4.80.37.....	375	425	7,257	6,180	-
E4.80/H4.80.38.....	387	438	7,352	6,228	-
E4.80/H4.80/R4.80.40.....	400	450	7,572	6,338	≈10,210
E4.80/H4.80.41.....	412	463	7,510	6,307	-
E4.80/H4.80.42.....	425	475	7,749	6,426	-
E4.80/H4.80.43.....	437	488	7,621	6,362	-
E4.80/H4.80.45.....	450	500	7,890	6,497	-
E4.80/H4.80.46.....	462	513	7,851	6,477	-
E4.80/H4.80.47.....	475	525	7,884	6,494	-
E4.80/H4.80.48.....	487	538	8,086	6,595	-
E4.80/H4.80.50.....	500	550	8,093	6,598	-
E4.80/H4.80.51.....	512	563	8,165	6,634	-
E4.80/H4.80.52.....	525	575	8,235	6,670	-
E4.80/H4.80.53.....	537	588	8,311	6,707	-
E4.80/H4.80.55.....	550	600	8,655	6,879	-
E4.80/H4.80.60.....	600	650	8,843	6,973	-



Order-key for further options and versions for this series ► page 7.88

System E4.1
Inner height: 80 mm

Phone +49- (0) 22 03-96 49-800
Fax +49- (0) 22 03-96 49-222

Available bending radii

R [mm] **150*** 200 250 300 350 400 500 550 600 1000

Supplement Part No. with required radius. Example: E4.80.30.300.0

0 = standard color, other colors ► page 1.39 · Pitch: 111 mm/link · Links/m = 9

More E-Tube widths are available upon request. Time of delivery approx. 8-10 weeks after order
*not available for R4.80



Extender crossbar for large diameter hoses ► page 7.84

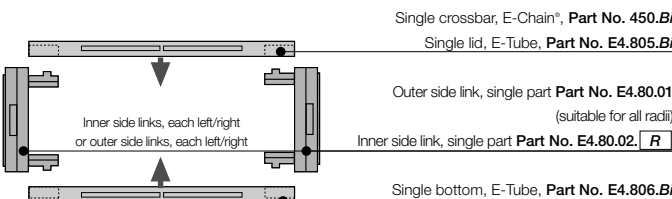

Part No. E-Chain® links, single parts

Inner side link
Outer side link

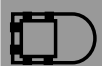

► page 7.15

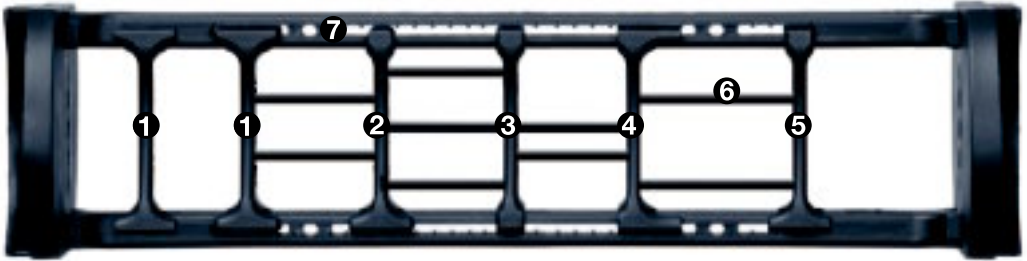

Optimized and extended interior separation range for Series E4.80. Wear optimized geometry with a high locking strength.
The very cable friendly design increases your cables cycle life even further. Universally suitable for E-Chains® and E-Tubes, 5x slotted!

Phone +49- (0) 22 03-96 49-800
Fax +49- (0) 22 03-96 49-222

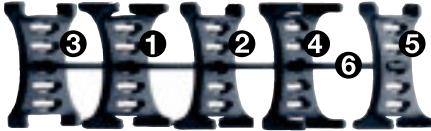

- ① Standard Separator, wide foot - Part. No. 80.1
- ② Separator for QuickLock crossbar - Part. No. 80.2
- ③ Narrow separator - Part. No. 80.3
- ④ Asymmetric separator - Part. No. 80.4
- ⑤ Notch separator - Part. No. 80.5

Realize a better separation with fewer, standardized parts

- Optimized and extended interior separation range
- The very cable friendly design increases your cables cycle life even further
- Same separation for E-Chains® and E-Tubes
- Safe force closure connection
- Cable friendly plastic crossbars, optimized for low cable wear and long cycle life
- Faster and easier assembly

igus® GmbH
51147 Cologne



⑥ Functionality - full-width shelf, lockable - Part. No. 520.XX

⑥ For horizontal separation: full-width shelf

- Shelf locks safely into separators on both ends through special locking clip
- Separators can be moved freely over the shelf in horizontal direction
- No side plates necessary
- Partial horizontal shelving possible



⑦ Standard* for all E4 crossbars and lids/bottoms: lock-in and scaling

*First few sizes available. Completion of the product range by the end of 2009

⑦ Notch crossbars, notch bottoms and lids

- No additional spacers necessary for side-mounted applications
- High locking strength of the separator in lock-in position
- Clearly visible, plane scaling
- Clearly notches and scaling on crossbars for E-Chains® and bottoms and lids of E-Tubes

Internet: www.igus.eu
E-mail: info@igus.de

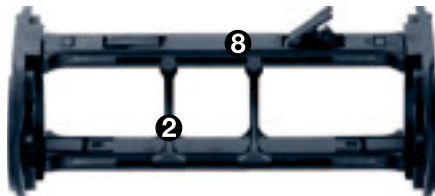

⑧ QuickLock crossbar, single part - Part No. 450.X.Q
(X = Inner width Bi E-Chains® / Q = QuickLock)

⑧ Optimized QuickLock crossbar

- One-click opening of the QuickLock crossbar = 25 % faster assembly compared to standard crossbars
 - Quick assembly/disassembly
 - Faster assembly with less effort
 - Free access to the top, E-Chain® can remain in the guide trough
- www.igus.de/en/E4schnelleMontage

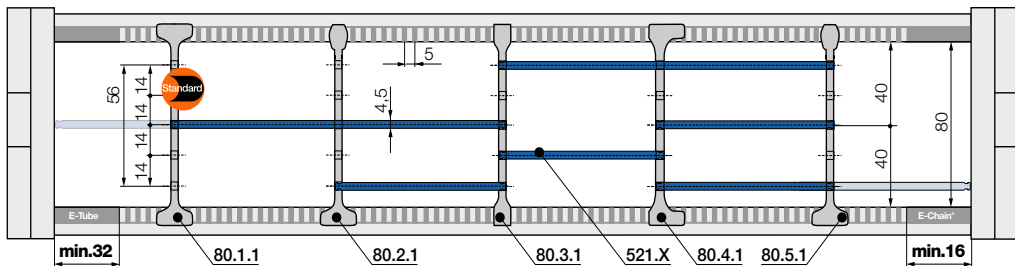

In the standard configuration, a separator is mounted at every second chain link!

Note: Observe a lateral spacing of at least 32 mm (E-Tube) and at least 16 mm (E-Chain)!

Standard - for all applications

① Separator with wide foot for maximum locking strength and safe standing in E-Chains® and E-Tubes

For even faster installation

② Separator for igus® ③ QuickLock crossbar 450.X.Q. Firm hold to one side with a wide foot, narrow on opposed side for easy cable assembly (slight grip)

For many thin cables

④ Separator with narrow feet for a large number of thin cables side by side. Saves space in E-Chains® and E-Tubes.

Fore side-mounted applications

⑤ Asymmetrical separator, for defined distance. No additional spacers necessary for E-Chains® and E-Tubes

Locks safely onto in 5 mm increments

⑥ Notch separator for ⑦ the new notch crossbar. With scaling on the notch crossbars. For exact positioning in E-Chains® and E-Tubes

Horizontal separation

⑧ Full-width shelf (Inner widths 50 - 450 mm). Shelf locks safely into separators on both ends, fixed width possible. Separators can be moved freely over the shelf in horizontal direction. Usable in 5 mm levels.

4 18		Standard separator, wide foot	
		unassembled 80.1	
		assembled 80.1.1	
8 4 18		Separator for QuickLock crossbar	
		unassembled 80.2	
		assembled 80.2.1	
4 8		Separator, narrow foot	
		unassembled 80.3	
		assembled 80.3.1	
4 3.5 10.5 18		Asymmetrical separator	
		unassembled 80.4	
		assembled 80.4.1	
8 4 18		Notch separator	
		unassembled 80.5	
		assembled 80.5.1	
		Full-width shelf, lockable	
		unassembled 520.X	
		assembled 521.X	
		XX = Width - see table below!	

Phone +49- (0) 22 03-96 49-800
Fax +49- (0) 22 03-96 49-222



Width X [mm]	Part No.		Width X [mm]	Part No.	
	unassembled	assembled		unassembled	assembled
050	520.050	521.050	175	520.175	521.175
062	520.062	521.062	200	520.200	521.200
075	520.075	521.075	225	520.225	521.225
100	520.100	521.100	250	520.250	521.250
125	520.125	521.125	300	520.300	521.300
150	520.150	521.150	450	520.450	521.450



Interior separation configurator online ► www.igus.eu/iaconfigurator



Standard 02 - Proven and tested interior separation elements for special and extremely variable partitioning! For use with many cables of differing diameters. E-Chains® and E-Tubes can be subdivided both vertically and horizontally.

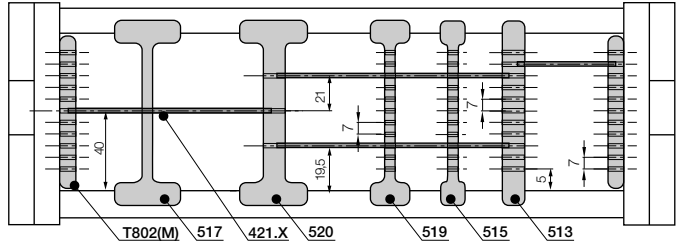

Split separator
T803, to be split
for shelf 420.X



Side plate
T802



Middle plate
503



Locking vertical
separator
510



Locking separator
slotted
507



Slotted
separator
505



Open slotted
separator
509



Shelf 420.X

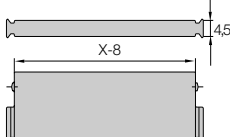

Split separator for E-Chains®	
unassembled	T803
assembled	T803M



Side plate for E-Chains®	
unassembled	T802
assembled	T802(M)



Middle plate for E-Chains®	
unassembled	503
assembled	513



Locking vertical separator for E-Chains®	
unassembled	510
assembled	520



Locking separator for E-Chains®	
unassembled	507
assembled	517



Slotted separator for E-Chains®	
unassembled	505
assembled	515

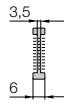

Open slotted separator for E-Chains®	
unassembled	509
assembled	519

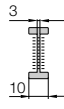

More proven interior separation elements

● **Split separator T803** - ideal for subsequent shelving or for the initial assembly of the E-Chain®. Fast assembly and disassembly possible through hinge/push mechanism. Saves assembly time. Enhances flexibility. (For Shelf 420.X).

● **Side plates 502, middle plates 503 and shelves 420.X** form the basic pattern of a shelf system. Shelves of various widths can be arranged at 11 different heights (in 7 mm increments).

● **Locking vertical separator 510** combined with shelves. Triple slots (only for E-Chains®).

● **Locking separator 507 slotted** - with increased retention force for applications exposed to very high humidity or extreme loads. The extra retention force is achieved by asymmetric claws for the crossbar. Ensure proper alignment.

● **Slotted separators 505** are used for very fine subdivisions. However, they cannot be retrofitted into an existing separation system without dismantling the interior separators first.

● The unilateral **open slotted separator 509** can be retrofitted into an existing interior separation system without a need for dismantling the interior separators. During an installation of open slotted separators, the top and bottom notches cannot be occupied by shelves.

Width X [mm]	Part No. unassembled	Part No. assembled
018	420.18	421.18
023	420.23	421.23
025	420.25	421.25
028	420.28	421.28
033	420.33	421.33
043	420.43	421.43
050	420.50	421.50
062	420.62	421.62

Width X [mm]	Part No. unassembled	Part No. assembled
075	420.75	421.75
088	420.88	421.88
100	420.100	421.100
125	420.125	421.125
150	420.150	421.150
175	420.175	421.175
187	420.187	421.187
200	420.200	421.200

For new constructions, we recommend the new igus® interior separation kit
Previous interior separation - will continue to be available!



E4.80
H4.80
R4.80

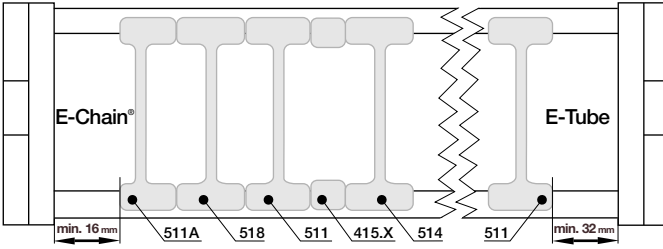

Vertical separators are used if a vertical subdivision is required. In the standard configuration, a separator is mounted at every second E-Chain® link. **Note:** Observe a lateral spacing of at least 32 mm (E-Tube) and 16 mm (E-Chain)! (Exception: No minimum spacing for side plates)

Vertical separators and spacers

● Standard separator 501 for E-Chains® offers safe stability due to its broad foot design, also when used with thick cables or hoses.



Vertical separator for E-Chains®	
unassembled	501
assembled	511

● Separators (e.g. "side mounted") for E-Chains® can be fixed in their position with spacers 405.XX. The available inner height will be reduced by 2 mm, per spacer and side. To avoid this, the parts can be assembled on outside of the crossbar (not for long travels) XX = width of the spacer (available 10, 15, 20, 30 and 40 mm)



Spacer* for E-Chains®	
unassembled	405.XX
assembled	415.XX

● Locking separator for E-Chains® 504- with increased retention force for applications exposed to very high humidity or extreme loads. If locking separators are used, the E-Chain® is more difficult to open



Locking separator for E-Chains®	
unassembled	504
assembled	514

● The locking separator for E-Chains® 508 is designed for applications exposed to extremely high humidity, for example, at composting plants. The lateral cam serves for uniform alignment of the vertical separators; if these separators are misaligned, they will inevitably get damaged on an attempt to open the E-Chain®.



Locking separator for E-Chains®	
unassembled	508
assembled	518

● Asymmetric separator 501A for E-Chains® (not for E-Tubes) with an 18-mm base, for combinations between spacers of different widths and vertical separators in side-mounted applications, for instance.



Asymmetric separator for E-Chains®	
unassembled	501A
assembled	511A

*For side-mounted applications



Vertical separator 501



Spacer 405.XX



Locking separator 504



Locking separator 508



Asymmetric separator 501A

System E4.1
Inner height: 80 mm

Phone +49- (0) 22 03-96 49-800
Fax +49- (0) 22 03-96 49-222



► page 7.15

Additional elements for interior separation

	Rollclip	
	unassembled	489.27
	assembled	490.27

Rollclip - minimizes abrasion of particularly sensitive hoses - simply clamped onto the opening crossbar. The movable rollers compensate for relative movement between the chain and hose.

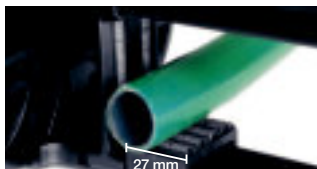



Extension links - for extremely wide E-Chains® up to 3 m

- For applications in which particularly high fill weights necessitate extremely wide E-Chains®
- The extension link design allows virtually limitless side-by-side attachment of chains
- The unsupported length of a E-Chain® can be increased when additional loads are required
- Extension links can be used with E-Chains®, E-Tubes or as a combination of both
- They are suitable for unsupported and gliding applications in a guide trough
- E-Chains® with extension links are attached with KMA or steel mounting brackets

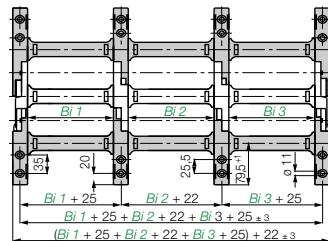

Part No. structure

E4.80.10 /20 /10. .0

E4.80.Bi1/Bi2/Bi3. .0



Extender crossbars - careful guide of hoses applications

- Suitable for hoses with a maximum outer diameter of 270 mm
- Gliding operation with crossbars assembled along the outer radius and a special guide trough
- Gliding operation not guaranteed with crossbars assembled along the inner radius
- The extender crossbar can either be attached to the side links directly or can be used in combination with two stranded snap-open crossbars

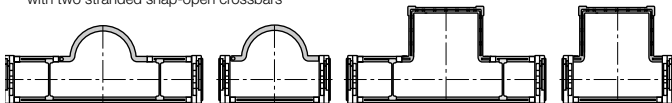

Consult igus® for your extender crossbar applications. We are happy to assist you with your design layout

Round extender crossbar combined with snap-open crossbars

Attached directly to the side link

Square extender crossbar with snap-open crossbars

Attached directly to the side link

Part No.	Max Ø [mm] hose	Form	Installation side link	Combination with snap-open crossb.
450.15.RHD115	115	○	-	+
450.17.RD115	115	○	+	-
450.25.D150	150	□	+	-
450.30.D200	200	□	+	-
450.35.D250	220	□	+	-
450.40.D300	270	□	+	-
450.20.HD150	150	□	-	+
450.25.HD200	200	□	-	+
450.30.HD250	220	□	-	+

○ = round □ = square + = yes / - = no



E4 clip-on cable binder

- For side-mounted applications
- Serves as a clip-on, lateral guide for hoses and cables on E-Chains®
- The loops can be adjusted as required
- Compatible with many E4 E-Chains®
- Stylish and economical
- One clip and one locking band are needed for each chain link
- Call us if you have any questions on project planning

Part No.	Form
450.B12	Locking clip, comprising a locking element
450.B12.200	Locking band, comprising a locking element and band; 12 x 1,5 x 200 mm

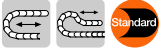

The Standard - Option KMA* - pivoting

- Recommended for unsupported and gliding applications
- Universal mountable with attachment capability on all sides
- Bolted connection outside of chain cross-section
- Confined installation conditions
- Corrosion resistant

*KMA = Polymer Metal Mounting Bracket

Moving end

E4.800/R4.800....2

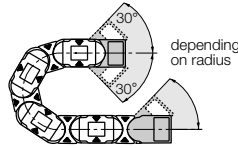

Fixed end

E4.800/R4.800....1



The attachment variants arising automatically by the choice of the KMA mounting bracket

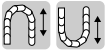
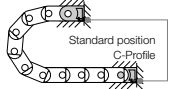

Option KMA - locking

- Recommended for vertical hanging / standing applications

Additionally:

- Universal mountable
- C-profile option
- Corrosion resistant
- Locked connections
- At very high acceleration

Moving end

E4.801/R4.801....2

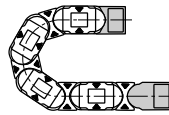

Fixed end

E4.801/R4.801....1



The attachment variants arising automatically by the choice of the KMA mounting bracket

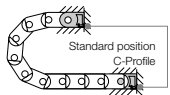

Fixed end

E4.800/R4.800....1 (pivoting)

E4.801/R4.801....1 (locking)

Moving end

(pivoting) E4.800/R4.800....2

(locking) E4.800/R4.801....2

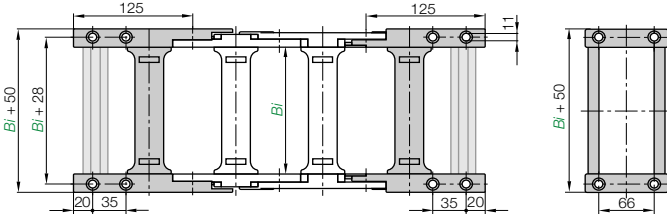

Width				Width					
index	Part No. full set		Bi	index	Part No. full set		Bi		
	pivoting	locking	[mm]		pivoting	locking	[mm]		
.05.	E4.800	E4.801	.05. <input type="text"/> .12. <input type="text"/>	50	.31.	E4.800	E4.801	.31. <input type="text"/> .12. <input type="text"/>	312
.06.	E4.800	E4.801	.06. <input type="text"/> .12. <input type="text"/>	65	.32.	E4.800	E4.801	.32. <input type="text"/> .12. <input type="text"/>	325
.07.	E4.800	E4.801	.07. <input type="text"/> .12. <input type="text"/>	75	.33.	E4.800	E4.801	.33. <input type="text"/> .12. <input type="text"/>	337
.08.	E4.800	E4.801	.08. <input type="text"/> .12. <input type="text"/>	87	.35.	E4.800	E4.801	.35. <input type="text"/> .12. <input type="text"/>	350
.10.	E4.800	E4.801	.10. <input type="text"/> .12. <input type="text"/>	100	.36.	E4.800	E4.801	.36. <input type="text"/> .12. <input type="text"/>	362
.11.	E4.800	E4.801	.11. <input type="text"/> .12. <input type="text"/>	112	.37.	E4.800	E4.801	.37. <input type="text"/> .12. <input type="text"/>	375
.12.	E4.800	E4.801	.12. <input type="text"/> .12. <input type="text"/>	125	.38.	E4.800	E4.801	.38. <input type="text"/> .12. <input type="text"/>	387
.13.	E4.800	E4.801	.13. <input type="text"/> .12. <input type="text"/>	137	.40.	E4/R4.800	E4/R4.801	.40. <input type="text"/> .12. <input type="text"/>	400
.15.	E4.800	E4.801	.15. <input type="text"/> .12. <input type="text"/>	150	.41.	E4.800	E4.801	.41. <input type="text"/> .12. <input type="text"/>	412
.16.	E4.800	E4.801	.16. <input type="text"/> .12. <input type="text"/>	162	.42.	E4.800	E4.801	.42. <input type="text"/> .12. <input type="text"/>	425
.17.	E4.800	E4.801	.17. <input type="text"/> .12. <input type="text"/>	175	.43.	E4.800	E4.801	.43. <input type="text"/> .12. <input type="text"/>	437
.18.	E4.800	E4.801	.18. <input type="text"/> .12. <input type="text"/>	187	.45.	E4.800	E4.801	.45. <input type="text"/> .12. <input type="text"/>	450
.20.	E4/R4.800	E4/R4.801	.20. <input type="text"/> .12. <input type="text"/>	200	.46.	E4.800	E4.801	.46. <input type="text"/> .12. <input type="text"/>	462
.21.	E4.800	E4.801	.21. <input type="text"/> .12. <input type="text"/>	212	.47.	E4.800	E4.801	.47. <input type="text"/> .12. <input type="text"/>	475
.22.	E4.800	E4.801	.22. <input type="text"/> .12. <input type="text"/>	225	.48.	E4.800	E4.801	.48. <input type="text"/> .12. <input type="text"/>	487
.23.	E4.800	E4.801	.23. <input type="text"/> .12. <input type="text"/>	237	.50.	E4.800	E4.801	.50. <input type="text"/> .12. <input type="text"/>	500
.25.	E4/R4.800	E4/R4.801	.25. <input type="text"/> .12. <input type="text"/>	250	.51.	E4.800	E4.801	.51. <input type="text"/> .12. <input type="text"/>	512
.26.	E4.800	E4.801	.26. <input type="text"/> .12. <input type="text"/>	262	.52.	E4.800	E4.801	.52. <input type="text"/> .12. <input type="text"/>	525
.27.	E4.800	E4.801	.27. <input type="text"/> .12. <input type="text"/>	275	.53.	E4.800	E4.801	.53. <input type="text"/> .12. <input type="text"/>	537
.28.	E4.800	E4.801	.28. <input type="text"/> .12. <input type="text"/>	287	.55.	E4.800	E4.801	.55. <input type="text"/> .12. <input type="text"/>	550
.30.	E4/R4.800	E4/R4.801	.30. <input type="text"/> .12. <input type="text"/>	300	.60.	E4.800	E4.801	.60. <input type="text"/> .12. <input type="text"/>	600

Please insert for odd number of links or for even number of links

Dimensions and order configurations

Part No. structure (pivoting)

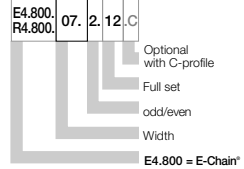

Part No. structure (locking)

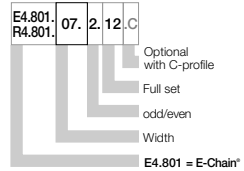

Note: The E4.1 System may end with either an inner side or an outer side link. Keep in mind that an outer side link always forms the first chain link at the moving end. The Part No. depend on an even or odd numbers of links. Please insert: for odd number of links or for even number of links

Full set, for both ends:

E4.800, (even)

Single-part order:

E4.800, . . . (even)

Mounting bracket moving end

E4.800, . . . (even)

Mounting bracket fixed end





Chainfix steel clamps and Chainfix stainless-steel clamps - max. pull forces, adjustable with hexagon socket. Available as single, double or triple clamps

Chainfix clamps for the C-profile

Part No. single clamps		Part No. double clamps		Part No. triple clamps		Cable
steel	stainless steel	steel	stainless steel	steel	stainless steel	ø [mm]
CFX12.1	CFX12.1.E	CFX12.2	CFX12.2.E	CFX12.3	-	06 - 12
CFX14.1	CFX14.1.E	CFX14.2	CFX14.2.E	CFX14.3	-	12 - 14
CFX16.1	CFX16.1.E	CFX16.2	CFX16.2.E	CFX16.3	-	14 - 16
CFX18.1	CFX18.1.E	CFX18.2	CFX18.2.E	CFX18.3	-	16 - 18
CFX20.1	CFX20.1.E	CFX20.2	CFX20.2.E	CFX20.3	-	18 - 20
CFX22.1	CFX22.1.E	CFX22.2	CFX22.2.E	CFX22.3	-	20 - 22
CFX26.1	CFX26.1.E	CFX26.2	CFX26.2.E	-	-	22 - 26
CFX30.1	CFX30.1.E	CFX30.2	CFX30.2.E	-	-	26 - 30
CFX34.1	CFX34.1.E	CFX34.2	CFX34.2.E	-	-	30 - 34
CFX38.1	CFX38.1.E	-	-	-	-	34 - 38
CFX42.1	CFX42.1.E	-	-	-	-	38 - 42



Chainfix Clip - Modular snap-on strain relief device for C-profile

Available for all igus® E-ChainSystems® with C-profiles and also suitable for assembly in the KMA mounting brackets and Clip-on strain relief for crossbars. High pull forces, plug-in modular snap-on strain relief device. **Details ▶ chapter 10**

Cable ø [mm]	Part No. clamp	Part No. bottom part
04 - 08	CFC-08-M	CFC-08-C
08 - 12	CFC-12-M	CFC-12-C
12 - 16	CFC-16-M	CFC-16-C
16 - 20	CFC-20-M	CFC-20-C
20 - 24	CFC-24-M	CFC-24-C



Chainfix Nugget for the C-Profile

Strain relief for the fixation of cables up to a diameter of Ø 30 mm. Easy to assemble, without any screws and tools. Easy strain relief due to fixation with pre-harnessed cable strap, very small space requirement. **Details ▶ chapter 10**

Part No.	ø max. conduit [mm]	Width [mm]
CFN.20	20	10,8
CFN.30.52	30	16,8
CFN.20.N35	20	20,0

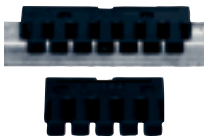

Chainfix tiwrap plates with clip-on connection for the C-profile

Can be plugged into the KMA C-profile. Easy to assemble without any screws. Easily solvable with screwdriver nevertheless safe stop. For all E-Chains® with KMA and integrated C-profile. **Details ▶ chapter 10**

Part No.	Width of strain relief [mm]	Number of teeth
3050.ZC	50	5
3075.ZC	75	7

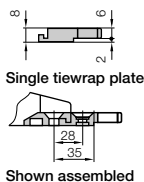

Chainfix tiwrap plate as individual part

As individual component screwed on KMA, can also be plugged into the mounting bracket. **Details ▶ chapter 10**

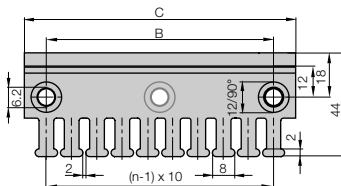

Tiwrap plate	No. of teeth n	Dim. C [mm]	Dim. B [mm]	Center bore
3050.ZB	5	50	30	-
3075.ZB	7	75	55	-
3100.ZB	10	100	80	-
3115.ZB	11	115	95	-
3125.ZB	12	125	105	-
3150.ZB	15	150	130	-
3175.ZB	17	175	155	-
3200.ZB	20	200	180	+
3225.ZB	22	225	205	+
3250.ZB	25	250	230	+

(- = no / + = yes)

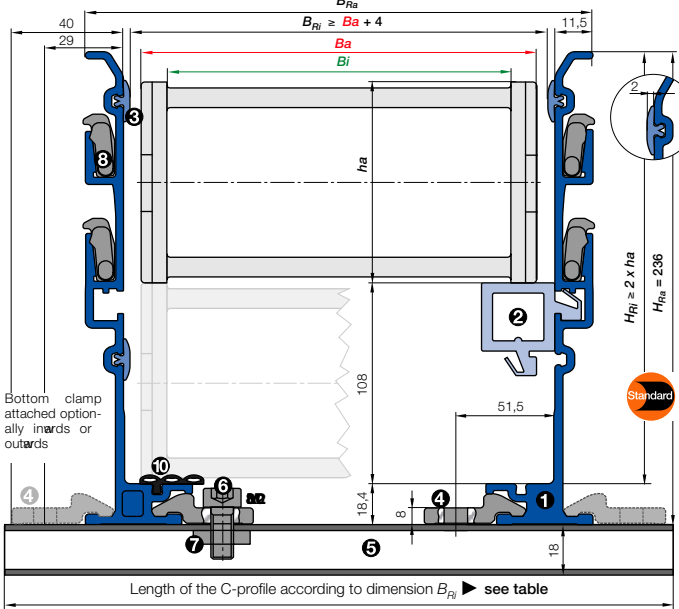

- B_a** = Outer width E-Chains * /E-Tube
 - B_i** = Inner width E-Chains * /E-Tube
 - h_a** = Outer height E-Chains * /E-Tube
 - H_{Ri}** = Inner trough height
 - H_{Ra}** = Outer trough height
 - B_{Ri}** = Inner trough width ▶ depends on dim. B_a
 - B_{Ra}** = Outer trough width
 - n_{Mon}** = Number of installation sets (left/right)
 - n_{Ri}** = Number of trough sets (left/right)
 - H_{Ri} ≥ 2 • h_a**
 - B_{Ri} ≥ B_a + 4**
- = Guide trough set
 - = Installation set "Basic"
 - = C-Profile
 - = Glide trough set
 - = Glide bar

Installation set "Basic" with C-Profile

Bottom Clamp attached optionally inwards or outwards

E4.80.30.300.0 ▶ Other example

B _{Ri} [mm]	Part No.	
	attached inwards	attached outwards
.05	104	960.50.225
.06	119	960.50.250
.07	129	960.50.250
.08	141	960.50.200
.10	154	960.50.225
.11	167	960.50.225
.12	179	960.50.250
.13	192	960.50.250
.15	204	960.50.275
.16	217	960.50.275
.17	229	960.50.300
.18	242	960.50.300
.20	254	960.50.325
.21	267	960.50.325
.22	279	960.50.350
.23	292	960.50.350
.25	304	960.50.375
.26	317	960.50.375
.27	329	960.50.400
.28	342	960.50.400
.30	354	960.50.425
.31	367	960.50.425
.32	379	960.50.450
.33	392	960.50.450
.35	404	960.50.475
.36	417	960.50.475
.37	429	960.50.500
.38	442	960.50.500
.40	454	960.50.525
.41	467	960.50.525
.42	479	960.50.550
.43	492	960.50.550
.45	504	960.50.575
.46	517	960.50.575
.47	529	960.50.600
.48	542	960.50.600
.50	554	960.50.625
.51	567	960.50.625
.52	579	960.50.650
.53	592	960.50.650
.55	604	960.50.675
.60	654	960.50.725

- **Components, trough "Basic":** ① Trough side parts, aluminum, 2 m
- ② Glide bar, plastic, 2 m
- ③ Glide strips, plastic, 2 m (without glide strips on request)
- ⑩ Optional: Silencer profile, rubber
- **Components, installation set "Basic":** ④ Bottom clamp, aluminum
- ⑤ C-profile, steel galvanized
- ⑥ Screw M120
- ⑦ Spring nut M1
- ⑧ Interface connector, plastic

Order example: Length of travel 30 m - Center mounted for Series E4.80.30.300.0 with B_{Ri} = 345

Guide trough set (set of 2 trough side parts, incl. glide strips) **without** glide bar
Order text: 16 m guide trough without glide bar (8 x 2 m sections) Part No. 975.30.SL

Guide trough set (set of 2 trough side parts, incl. glide strips) **with** glide bar
Order text: 16 m guide trough with glide bar (8 x 2 m sections) Part No. 975.31.SL

Installation set "Basic" complete (guide trough-sets + 1)
Order text: 17 installation sets "Basic" Part No. 960.50.425

Module for the fixed end
Order text: 1 set Part No. 975.80

Option: for an additional noise dampening with dampening profile, please add Index A Example:
Part No. 975.30.SLA

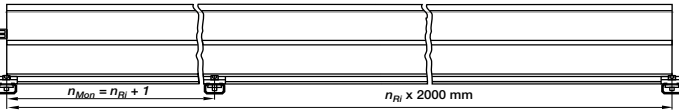

Principle sketch: Number of installation sets to be installed = Number of trough sections + 1

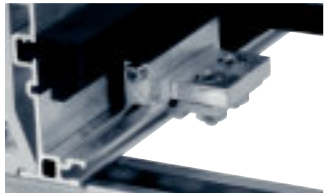

A quick fix for mounting the stationary end of an E-Chain®

With this module for the fixed end, fast and easy mounting onto the Aluminum SuperTrough™s now possible without any drilling. Fast mounting of the E-Chain® by clamping onto the aluminum trough

- Quick relocation of the stationary end
- No drilling necessary ▶ page 9.16

Insert for the installation set "Heavy-Duty" (960.50.XXX) on the right column attached outwards"

Phone +49- (0) 22 03-96 49-800
 Fax +49- (0) 22 03-96 49-222

▶ chapter 10

▶ chapter 9

▶ page 7.15

Standard

Part. No.
Standard
E-Chains®/E-Tubes



E4.80.30.R.0
(Crossbar every link)

H4.80.30.R.0
(Crossbar every 2nd link)

R4.80.30.R.0
(E-Tube, closed)

Delivery time
24h or today

Additional noise dampening with pads

Part. No.
Low noise (with pads)
E-Chains®/E-Tubes



ES4.80.30.R.0
(Crossbar every link)

HS4.80.30.R.0
(Crossbar every 2nd link)

RS4.80.30.R.0
(E-Tube, closed)

Delivery time
3-5 workdays

QuickLock crossbar - save up to 25% assembly time

Part. No.
QuickLock crossbar*
for inner radius



E4.80.30.QZ.R.0
(Crossbar every link)

H4.80.30.QZ.R.0
(Crossbar every 2nd link)

R4.80.30.QZ.R.0**
(E-Tube, closed)

Delivery time
3-5 workdays

Part. No.
QuickLock crossbar*
for Outer radius

QuickLock crossbars: smallest inner width from B/15 (150 mm)!

E4.80.30.QE.R.0
(Crossbar every link)

H4.80.30.QE.R.0
(Crossbar every 2nd link)

R4.80.30.QE.R.0**
(E-Tube, closed)

Delivery time
3-5 workdays

Part. No.
QuickLock crossbar*
both sides

E4.80.30.Q.R.0
(Crossbar every link)

H4.80.30.Q.R.0
(Crossbar every 2nd link)

R4.80.30.Q.R.0**
(E-Tube, closed)

Delivery time
3-5 workdays

* available from fall 2009
** upon request

* available from fall 2009
** upon request

* available from fall 2009
** upon request

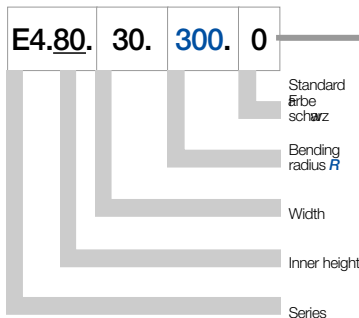
Order example - Standard

All E-Chains® made from igumid G are available in the colors listed in the table. Additional colors are usually feasible. (Standard color black). Colored E-Chains® are basically not available from stock.

Color options for igus® E-Chains® and E-Tubes. Standard color black (from stock)

E-Chains®/E-Tubes	igus® color index	Ral-numbers (approx.)	Delivery time
Material color			
black	Index .0	⇒ RAL 9004	from stock
white*	Index .1	⇒ RAL 9003	2-4 weeks
violet*	Index .5	⇒ RAL 4008	2-4 weeks
yellow*	Index .4	⇒ RAL 1018	2-4 weeks
orange*	Index .2	⇒ RAL 2003	2-4 weeks
red*	Index .6	⇒ RAL 3002	2-4 weeks
blue*	Index .8	⇒ RAL 5005	2-4 weeks
green*	Index .7	⇒ RAL 6011	2-4 weeks
grey*	Index .3 (E-Chains®)	⇒ RAL 7023	2-4 weeks
dusty grey*	Index .3 (E-Tubes)	⇒ RAL 7037	2-4 weeks
agate grey*	Index .11	⇒ RAL 7038	2-4 weeks
light grey*	Index .14	⇒ RAL 7035	2-4 weeks
black grey*	Index .13	⇒ RAL 7021	2-4 weeks
yellow/black*	Index .9	–	2-4 weeks

*Delivery Time and pricing for colored E-Chains® upon request!

Easy turning of the outer link without rework

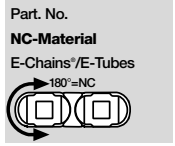

E4.80.30.R.0.NC
(Crossbar every link)

H4.80.30.R.0.NC
(Crossbar every 2nd link)

R4.80.30.R.0.NC
(E-Tube, closed)

Delivery time
24h or today

Reverse bending radius for circular movements

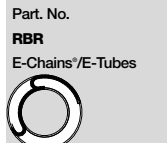

E4.80.30.R1/R2.0
(Crossbar every link)

H4.80.30.R1/R2.0
(Crossbar every 2nd link)

R4.80.30.R1/R2.0
(E-Tube, closed)

Delivery time
3-5 workdays

Unsupported lengths +25% possible

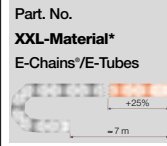

E4.80.30.R.0.XXL
(Crossbar every link)

H4.80.30.R.0.XXL
(Crossbar every 2nd link)

R4.80.30.R.0.XXL
(E-Tube, closed)

Delivery time
1-2 weeks

*Sidelbands made from XXL-Material

No burning-in of hot chips up to 850°C (1562° F)

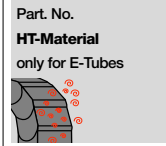

R4.80.30.R.0.HT
Complete E-Tube*

R4.80.30.HT.R.0
Lid and bottom

R4.80.30.HTZ.R.0
Bottom only

R4.80.30.HTE.R.0
Lid only

Delivery time
up to 4 weeks

*for gliding applications please consult igus®

ATEX/ESD classified E-Chains® - II 2 GD

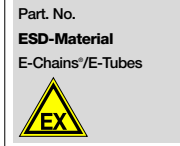

E4.80.30.R.0.ESD
(Crossbar every link)

H4.80.30.R.0.ESD
(Crossbar every 2nd link)

R4.80.30.R.0.ESD
(E-Tube, closed)

Delivery time
up to 2 weeks

Combination possibilities, examples:

	Low noise Option	QuickLock crossbar	NC-Version	RBR-Version	XXL-Material	HT-Material*	ESD-Material
Low noise Option		ES4.80.30.Q.R.0	ES4.80.30.R.0.NC	-	ES4.80.30.R.0.XXL	RS4.80.30.R.0.HT	ES4.80.30.R.0.ESD
QuickLock crossbar	ES4.80.30.Q.R.0		E4.80.30.Q.R.0.NC	E4.80.30.Q.R1/R2.0	E4.80.30.Q.R.0.XXL	-	E4.80.30.Q.R.0.ESD
NC-Version	ES4.80.30.R.0.NC	E4.80.30.Q.R.0.NC		-	-	R4.80.30.R.0.HT.NC	E4.80.30.R.0.ESD.NC
RBR-Version	-	E4.80.30.Q.R1/R2.0	-		-	R4.80.30.R1/R2.0.HT	E4.80.30.R1/R2.0.ESD
XXL-Material	ES4.80.30.R.0.XXL	E4.80.30.Q.R.0.XXL	-	-		-	-
HT-Material*	RS4.80.30.R.0.HT	-	R4.80.30.R.0.HT.NC	R4.80.30.R1/R2.0.HT	-		-
ESD-Material	ES4.80.30.R.0.ESD	E4.80.30.Q.R.0.ESD	E4.80.30.R.0.ESD.NC	E4.80.30.R1/R2.0.ESD	-	-	

*for gliding applications please consult igus®

Price index



Series 1640

Series R1608



ESD classification:

Electrically conductive ESD/ATEX version upon request



High torsional rigidity



Side-mounted - unsupported



Opening E-Chains®: Remove crossbars and clips - Insert screwdriver into the slot, push down, release by lever action



Remove lids/bottoms (E-Tubes) - Insert screwdriver into the slot, release by lever action



When to use the Series 1640/R1608:

- For achieving simple, economical solutions
- For minimizing a chain's external width at any given internal width
- For use if Series 640 proves too large



When not to use it:

- If maximum stability is required
- ▶ Series 600/R608, page 7.200

- 1 Numerous interior separation possibilities
- 2 Wide, rounded plastic crossbars - cable friendly
- 3 Lateral glide surfaces for side-mounted operation
- 4 Closed and open styles can be combined
- 5 Hinged snap-open removable lids along outer radius
- 6 Removable lids along inner radius
- 7 Dirt-repellent exterior
- 8 E-Chains® also available with reverse bending radius "RBR"



Order example complete E-Chain®

Please indicate chain-lengths or number of links Example: 2 m or 14 links

2 m 1640.30.300.0



E-Chain®

with 2 separators 6411 assembled every 2" link



Interior separation

1 set 16000.1.12



Mounting bracket



Unsupported length

FL_G = with straight upper run

FL_B = with permitted sag

Further information ► **Design, page 1.12**

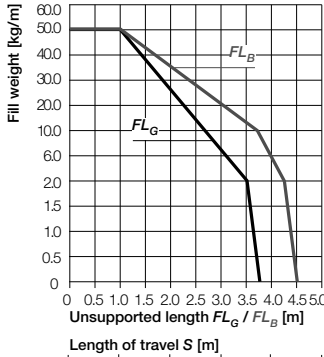
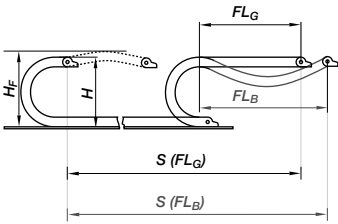

- S = Length of travel
 - R = Bending radius
 - H = Nominal clearance height
 - H_F = Required clearance height
 - H_{R1} = Trough inner height
 - D = Overlength E-Chain" radius in final position
 - $K = \pi \cdot R + \text{"safety"}$
 - D_2 = Over length - long travels, gliding
 - K_2 = "Further add-on
 - H_2 = "Mounting height
- *If the mounting bracket location is set lower

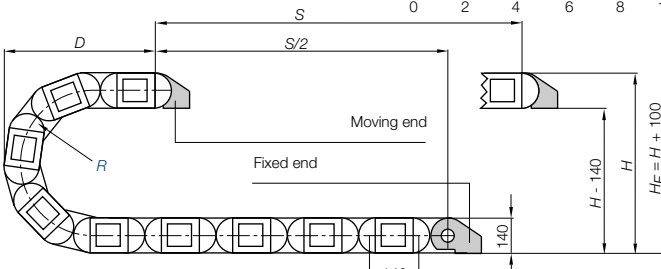

Pitch = 143 mm/link Links/m = 7 (1001 mm) Chain length = $S/2 + K$

R	200	250	300	350	400	450	500	550	600
H	545	645	747	845	945	1045	1145	1245	1345
D	415	465	515	565	615	665	715	765	815
K	920	1080	1240	1400	1560	1720	1870	2020	2175
H ₂	325	325	325	325	325	325	325	325	325
D ₂ *25	900	1000	1100	1250	1450	1600	1700	1900	2050
K ₂	1573	1716	1859	2288	2574	2860	3146	3432	3861

Other installation methods

- Vertical, hanging ≤ 100 m
- Vertical, standing ≤ 5 m
- Side mounted, un supp. ≤ 2 m
- Rotary requires further calculation
- Unsupported length of upper run = upon request

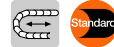

Short travels - unsupported

Unsupported E-Chains® feature positive camber over short travels. This must be accounted for when specifying the clearance height H_F . Please consult igus® if space is particularly restricted.

The required clearance height:
 $H_F = H + 100$ mm
(with 5,0 kg/m fill weight)

Long travel lengths from 10 m to max. 400 m Chain length = $S/2 + K_2$

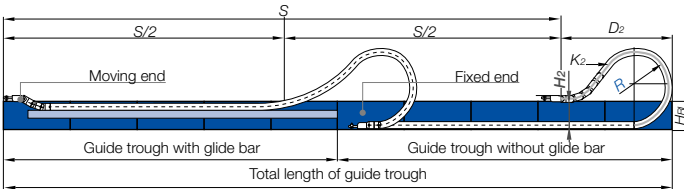

In case of travels between 4 and 10 m we recommend a longer unsupported length.



Gliding, long travel applications (max. 400 m)

In this case the E-Chain® upper run will be introduced in a guide trough on the lower run. We recommend to realize the engineering of such a plant by our technicians.

Technical Data

Speed / acceleration FL_G	max. 20 [m/s] / max. 200 [m/s ²]
Speed / acceleration FL_B	max. 3 [m/s] / max. 6 [m/s ²]
Gliding speed / acceleration (maximum)	max. 10 [m/s] / max. 50 [m/s ²]
Material - permitted temperature °C	igumid G / -40° up to +120° C
Flammability class, igumid G	VDE 0304 IIC UL94 HB



Details of material properties
► page 1.38

112

System E4/light
Inner height: 112 mm

Phone +49- (0) 22 03-96 49-800
Fax +49- (0) 22 03-96 49-222



► page 7.15

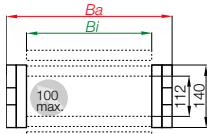

Part No. structure

1640. 30. 300. 0



Series 1640 - E-Chain® with crossbars every link

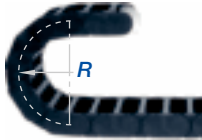

- Crossbars every link
- For rigid hydraulic hoses
- For applications particularly demanding
- Can be opened from two sides



Phone+49- (0) 22 03-96 49-800
Fax +49- (0) 22 03-96 49-222

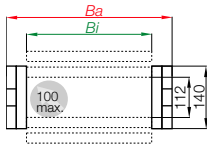

Part No. structure

1608. 30. 300. 0



Series R1608 - Fully enclosed E-Tube

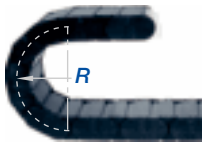

- Fully enclosed
- Excellent cable protection against dirt
- Protection against hot chips
- Lids along the entire inner radius are completely removable. Lids along the entire outer radius are single sided snap-open with a hinge on the other side to keep them attached to the chain or completely removable.



igus® GmbH
51147 Cologne

Internet: www.igus.eu
E-mail: info@igus.de

Part No.	<i>Bi</i>	<i>Ba</i>	1640	R1608
	[mm]	[mm]	[kg/m]	[kg/m]
1640.05.....	50	84	≈ 5,10	-
1640.06.....	65	99	≈ 5,18	-
1640.07.....	75	109	≈ 5,27	-
1640.08.....	87	121	≈ 5,31	-
1640.10.....	100	134	≈ 5,36	-
1640.11.....	112	146	≈ 5,45	-
1640.12.....	125	159	≈ 5,54	-
1640.13.....	137	171	≈ 5,63	-
1640.15.....	150	184	≈ 5,67	-
1640.16.....	162	196	≈ 5,74	-
1640.17.....	175	209	≈ 5,81	-
1640.18.....	187	221	≈ 5,88	-
1640/1608.20.....	200	234	≈ 5,89	upon request
1640.21.....	212	246	≈ 5,96	-
1640.22.....	225	259	≈ 6,01	-
1640.23.....	237	271	≈ 6,09	-
1640/1608.25.....	250	284	≈ 6,15	upon request
1640.26.....	262	296	≈ 6,20	-
1640.27.....	275	309	≈ 6,27	-
1640.28.....	287	321	≈ 6,29	-
1640/1608.30.....	300	334	≈ 6,34	upon request
1640.31.....	312	346	≈ 6,41	-
1640.32.....	325	359	≈ 6,48	-
1640.33.....	337	371	≈ 6,59	-
1640/1608.35.....	350	384	≈ 6,61	upon request
1640.36.....	362	396	≈ 6,67	-
1640.37.....	375	409	≈ 6,71	-
1640.38.....	387	421	≈ 6,76	-
1640/1608.40.....	400	434	≈ 6,89	upon request
1640.41.....	412	446	≈ 6,99	-
1640.42.....	425	459	≈ 7,08	-
1640.43.....	437	471	≈ 7,13	-
1640.45.....	450	484	≈ 7,17	-
1640.46.....	462	496	≈ 7,18	-
1640.47.....	475	509	≈ 7,22	-
1640.48.....	487	521	≈ 7,27	-
1640.50.....	500	534	≈ 7,35	-
1640.51.....	512	546	≈ 7,36	-
1640.52.....	525	559	≈ 7,39	-
1640.53.....	537	571	≈ 7,49	-
1640.55.....	550	584	≈ 7,80	-
1640.60.....	600	634	≈ 7,92	-

Available bending radii

R [mm] 200* 250 300 350 400 450 500 550 600

Supplement Part No. with required radius. Example: 1640.30.300.0

0 = standard color, other colors ▶ page 1.39 · Pitch = 143 mm/link - Links/m = 7

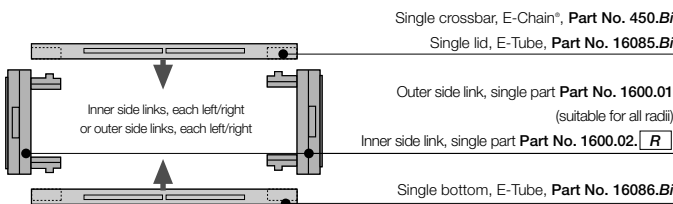

*not available for R1608



Extender crossbar for large diameter hoses ▶ page 7.96

Part No. E-Chain® links, single parts

Inner side link

Outer side link



System E4/light
Inner height: 112 mm

Phone +49- (0) 22 03-96 49-800
Fax +49- (0) 22 03-96 49-222



▶ page 7.15



Vertical separators are used if a vertical subdivision is required. In the standard configuration, a separator is mounted at every second E-Chain® link.

Note: Observe a lateral spacing of at least 33 mm (E-Tube) and 16 mm (E-Chain®)!

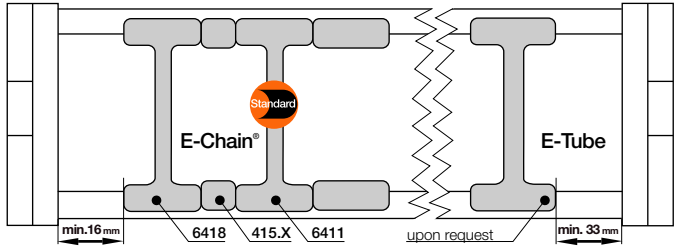

Vertical separator
6401



Spacer
405.XX



Locking separator
6408

Vertical separator for E-Chains®	
unassembled	6401
assembled	6411



Spacer*	
for E-Chains®	
unassembled	405.XX
assembled	415.XX



Locking separator for E-Chains®	
unassembled	6408
assembled	6418



*For side-mounted applications

Option 1: Vertical separators and spacers

● **Standard separator 6401 for E-Chains®** offers safe stability due to its wide base design, also when used with thick cables or hoses.

● Separators (e.g. "side mounted") for E-Chains® can be fixed in their position with **spacers 405.XX**. The available inner height will be reduced by 2 mm, per spacer and side. To avoid this, the parts can be assembled on outside of the crossbar (not for long travels) **XX = width of the spacer** (available 10, 15, 20, 30 and 40 mm)

Additionally:

● **Locking separator 6408 for E-Chains®** - with increased retention force for applications exposed to very high humidity or extreme loads. The extra retention force is achieved by asymmetric claws for the crossbar. Ensure proper alignment.

● **Vertical separator for E-Tubes R1608** upon request.

Phone +49- (0) 22 03-96 49-800
Fax +49- (0) 22 03-96 49-222

igus® GmbH
51147 Cologne

Internet: www.igus.eu
E-mail: info@igus.de

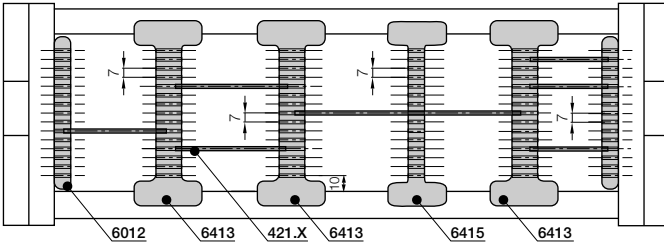

For use with many cables of differing diameters. E-Chains® and E-Tubes can be subdivided both vertically and horizontally. The shelves can be arranged elevator-shifted with different bottoms

Option 2: Shelves

● Side plates 6002, middle plates 6403 for E-Chains®, middle plates 6003 for E-Tubes and shelves 420.X form the basic pattern of a shelf system. Shelves of various widths can be arranged at 15 different heights (in 7 mm increments).

● The unilateral open, slotted separators 6405 (for E-Chains®) and 6005 (for E-Tubes) can be retrofitted into an existing interior separation system without a need for dismantling the interior separators. During an installation of open slotted separators, the top and bottom notches cannot be occupied by shelves.



Side plate for E-Chains®/E-Tubes
unassembled 6002
assembled 6012

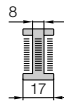

Middle plate for E-Chains®
unassembled 6403
assembled 6413



Middle plate for E-Tubes
unassembled 6003
assembled 6013



Open slotted separator for E-Chains®
unassembled 6405
assembled 6415



Open slotted separator for E-Tubes
unassembled 6005
assembled 6015

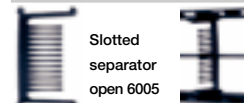
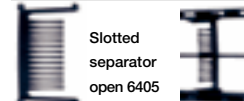

Width X [mm]	Part No. unassembled	Part No. assembled
018	420.18	421.18
023	420.23	421.23
025	420.25	421.25
028	420.28	421.28
033	420.33	421.33
043	420.43	421.43
050	420.50	421.50
062	420.62	421.62

Width X [mm]	Part No. unassembled	Part No. assembled
075	420.75	421.75
088	420.88	421.88
100	420.100	421.100
125	420.125	421.125
150	420.150	421.150
175	420.175	421.175
187	420.187	421.187
200	420.200	421.200

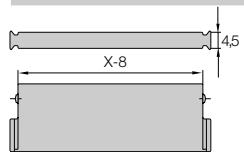

Additional elements for interior separation

Rollclip - minimizes abrasion of particularly sensitive hoses - simply clamped onto the opening crossbar. The movable rollers compensate for relative movement between the chain and hose.



Rollclip
unassembled 489.27
assembled 490.27

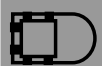



Extension links - for extremely wide E-Chains® up to 3,0 m

- For applications in which particularly high fill weights necessitate extremely wide E-Chains® (up to 3000 mm)
- The extension link design allows virtually limitless side-by-side attachment of chains
- The unsupported length of a chain can be increased when additional loads are required
- Extension links can be used with E-Chains®, E-Tubes or as a combination of both
- They are suitable for unsupported and gliding applications in a guide trough
- E-Chains® with extension links are attached with KMA or steel mounting brackets

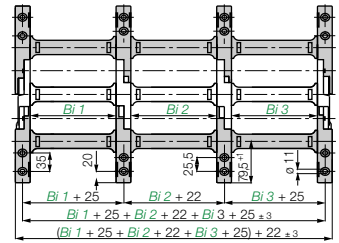
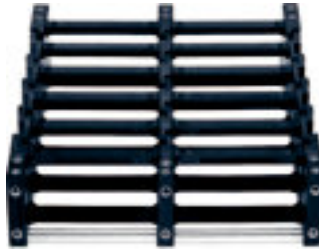

Part No. structure
1640.10 /20 /10. .0
1640.Bi1/Bi2/Bi3. .0



Extender crossbars - careful guide of hoses applications

- Suitable for hoses with a maximum outer diameter of 300 mm
- Gliding operation with crossbars assembled along the outer radius and a special guide trough
- Gliding operation not guaranteed with crossbars assembled along the inner radius
- The extender crossbar can either be attached to the side links directly or can be used in combination with two stranded snap-open crossbars

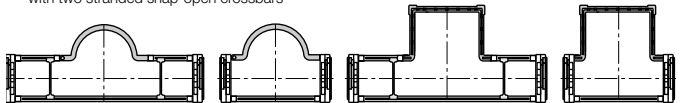

Round extender crossbar with snap-open crossbars Attached directly to the side link Square extender crossbar with snap-open crossbars Attached directly to the side link

Consult igus® for your extender crossbar applications. We are happy to assist you with your design layout

Part No.	Max Ø [mm] hose	Form	Installation side link	Combination with snap-open crossb.
450.15.RHD115	115	○	-	+
450.17.RD115	115	○	+	-
450.25.D150	150	□	+	-
450.30.D200	200	□	+	-
450.35.D250	250	□	+	-
450.40.D300	300	□	+	-
450.20.HD150	150	□	-	+
450.25.HD200	200	□	-	+
450.30.HD250	250	□	-	+

○ = round □ = square + = yes / - = no



E4 clip-on cable binder

- For side-mounted applications
- Serves as a clip-on, lateral guide for hoses and cables on E-Chains®
- The loops can be adjusted as required
- Compatible with many E4 E-Chains®
- Stylish and economical
- One clip and one locking band are needed for each chain link
- Call us if you have any questions on project planning

Part No.	Form
450.B12	Locking clip, comprising a locking element
450.B12.200	Locking band, comprising a locking element and band; 12 x 1,5 x 200 mm

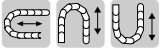

Option steel - pivoting

- For pivoting connections
- One part (two-piece) for all chain widths
- Electrically conductive

Moving end
16000.1

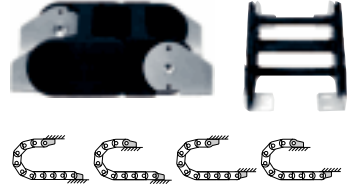
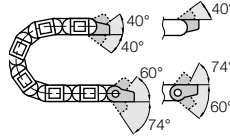

Fixed end
16000.2

Possible installation conditions -
Further installation angles ► installation sketch

Moving end
16000.1

Fixed end
16000.2

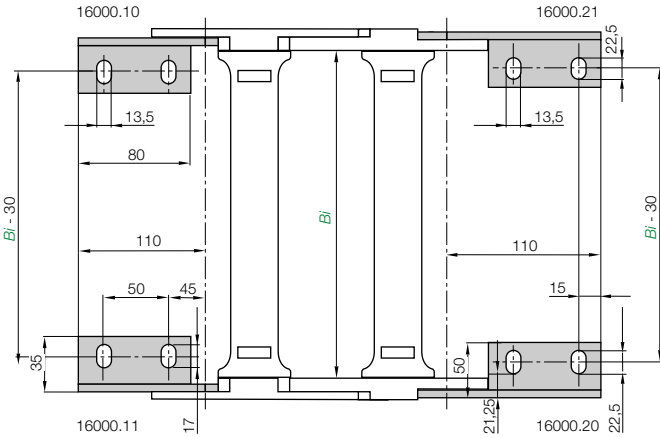

Part No.	Mounting bracket
16000.[1].12	Full attachment set (both sides) for E-Chain®, ending with outer side link
16000.[3].12	Full attachment set (both sides) for E-Chain®, beginning with outer side link (moving end), ending with inner side link (fixed end)
16000.1	Mounting bracket set moving end (one side) for outer side link
16000.2	Mounting bracket set fixed end (one side) for inner side link

Note mounting brackets:

Depending on the E-Chain® length, the carrier will end with outer or inner side links. For the best appearance, make sure the chain ends with outer side link whenever possible. An odd number of links will always end with outer side links.

E4.1 | Series 1640-R1608 | Accessories | Strain Relief

Tiewrap plate	No. of teeth	Dim. C [mm]	Dim. B [mm]	Center bore
3050.ZB	5	50	30	-
3075.ZB	7	75	55	-
3100.ZB	10	100	80	-
3115.ZB	11	115	95	-
3125.ZB	12	125	105	-
3150.ZB	15	150	130	-
3175.ZB	17	175	155	-
3200.ZB	20	200	180	+
3225.ZB	22	225	205	+
3250.ZB	25	250	230	+

(- = no / + = yes)

Tiewrap plate as individual part

As individual component screwed on KMA. Can be plugged in the mounting brackets. **Details ► chapter 10**

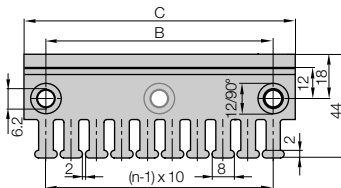

Single tiewrap plate



Shown assembled



- B_a = Outer width E-Chains® / E-Tube
- B_i = Inner width E-Chains® / E-Tube
- h_a = Outer height E-Chains® / E-Tube
- H_{Ri} = Inner trough height
- H_{Ra} = Outer trough height
- B_{Ri} = Inner trough width ▶ depends on dim. B_a
- B_{Ra} = Outer trough width
- n_{Mon} = Number of installation sets (left/right)
- n_{Ri} = Number of trough sets (left/right)
- $H_{Ri} \geq 2 \cdot h_a$
- $B_{Ri} \geq B_a + 5$
- = Guide trough set ● = Glide bar
- = Installation set ● = C-profile

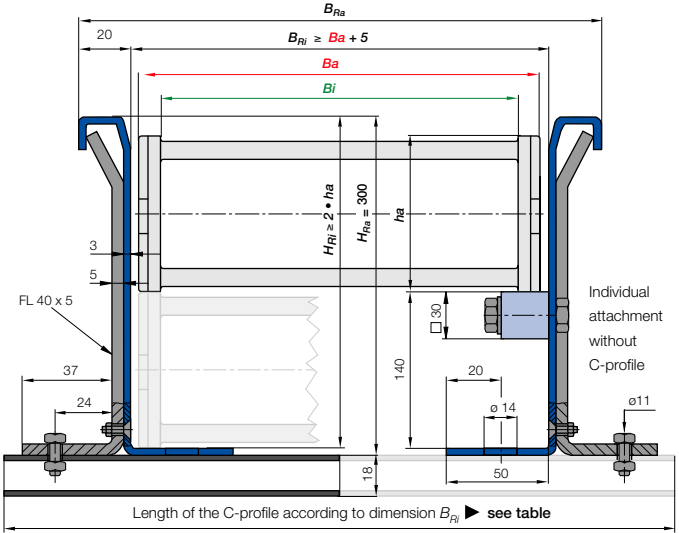

Installation set with C-profile

1640.12.300.0 ▶ Order example

	Part No.	Installation set
.05	89	-
.06	104	98.50.225
.07	114	98.50.250
.08	125	98.50.250
.10	139	98.50.275
.11	151	98.50.275
.12	164	98.50.300
.13	176	98.50.300
.15	189	98.50.325
.16	201	98.50.325
.17	214	98.50.350
.18	226	98.50.350
.20	239	98.50.375
.21	251	98.50.375
.22	264	98.50.400
.23	276	98.50.400
.25	289	98.50.425
.26	301	98.50.425
.27	314	98.50.450
.28	326	98.50.450
.30	339	98.50.475
.31	351	98.50.475
.32	364	98.50.500
.33	376	98.50.500
.35	389	98.50.525
.36	401	98.50.525
.37	414	98.50.550
.38	426	98.50.550
.40	439	98.50.575
.41	451	98.50.575
.42	464	98.50.600
.43	476	98.50.600
.45	489	98.50.625
.46	501	98.50.625
.47	514	98.50.650
.48	526	98.50.650
.50	539	98.50.675
.51	551	98.50.675
.52	564	98.50.700
.53	576	98.50.700
.55	589	98.50.725
.60	639	98.50.775

Guide troughs are used with applications where the upper run of the E-Chain® glides on the lower run. If usingigus® steel guide troughs, the following components are required:

- Guide trough without glide bars
Part No. 98.30
- Guide trough with glide bars
Part No. 98.31
- Installation sets as end connectors
Part No. 98.50.XX

XX indicates the length of the C-profile on which the guide trough is mounted. The values and part numbers are specified in the table on the left. Standard length of the trough components and glide bars is 2 m. The required overall length of the guide trough directly correlates to the length of travel. Special dimensions are available for confined spaces.



Illustration top: Guide trough with and without glide bar. Illustration bottom: installation set



Order example: Length of travel 30 m - Center mounted for Series 1640.12.300.0 with $B_{Ri} = 164$

- Guide trough set (set of 2 trough side parts, incl. glide strips) **without** glide bar
Order text: 16 m Guide trough without glide bar (8 x 2 m sections) Part No. 98.30
- Guide trough set (set of 2 trough side parts, incl. glide strips) **with** glide bar
Order text: 16 m Guide trough with glide bar (8 x 2 m sections) Part No. 98.31
- Installation set "Basic" complete (Guide trough-sets + 1)
Order text: 17 Installation sets (with C-profile) Part No. 98.50.300

Principle sketch: Number of installation sets to be installed = **Number of trough sections + 1**

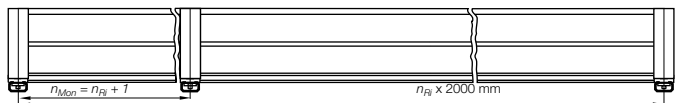

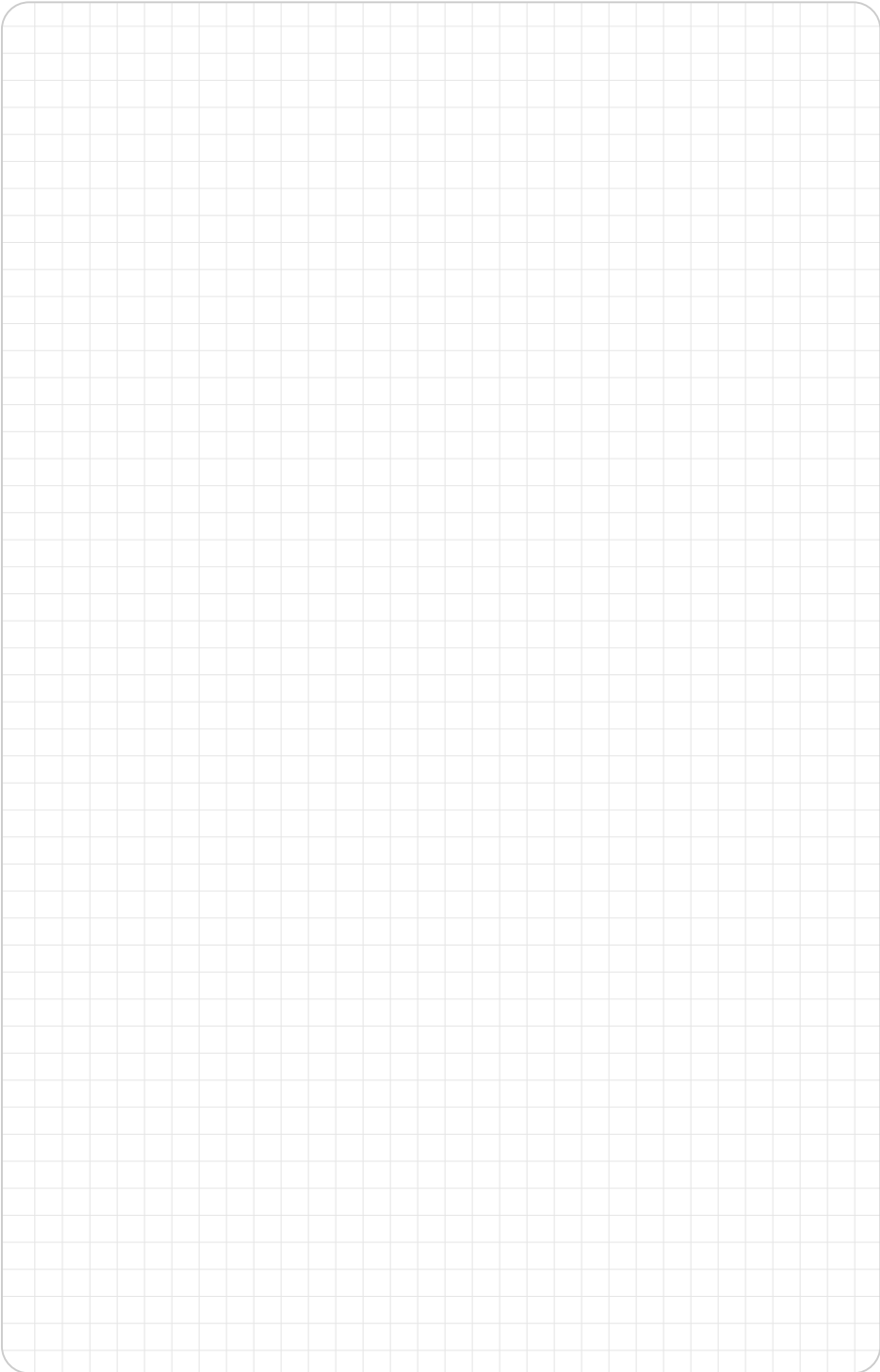

System E4/light
Inner height: 112 mm

Phone +49- (0) 22 03-96 49-800
Fax +49- (0) 22 03-96 49-222



▶ chapter 9



▶ page 7.15



Price index



ESD classification:
Electrically conductive ESD/ATEX
version upon request



Opening E-Chains: Remove crossbars and clips - Insert screwdriver into the slot, push down, release by lever action. Repeat action for the other side



You can find an assembly video on the
web ► www.igus.de/en/800_assembly



When to use the Series 800:

- If a particularly big and stable E-Chain® is required
- At very high speeds and/or accelerations
- For long travels
- For high additional loads



When not to use it:

- If a lighter, less stable E-Chain® with identical inner height is required
- Series 840, page 7.106

- ❶ Each chain link is made more rigid due to four opening crossbars, and consequently provides a great unsupported length
- ❷ Crossbars are removable along both radii
- ❸ Stop dog with "brake" for noise reduction
- ❹ Optimized glide pads with lateral wear allowance
- ❺ Wide, rounded plastic crossbars - cable friendly
- ❻ The biggest igus® polymer E-Chain®
- ❼ Dirt-repellent exterior
- ❽ E-Chains® also available with reverse bending radius "RBR"
- ❾ Undercut for more stability

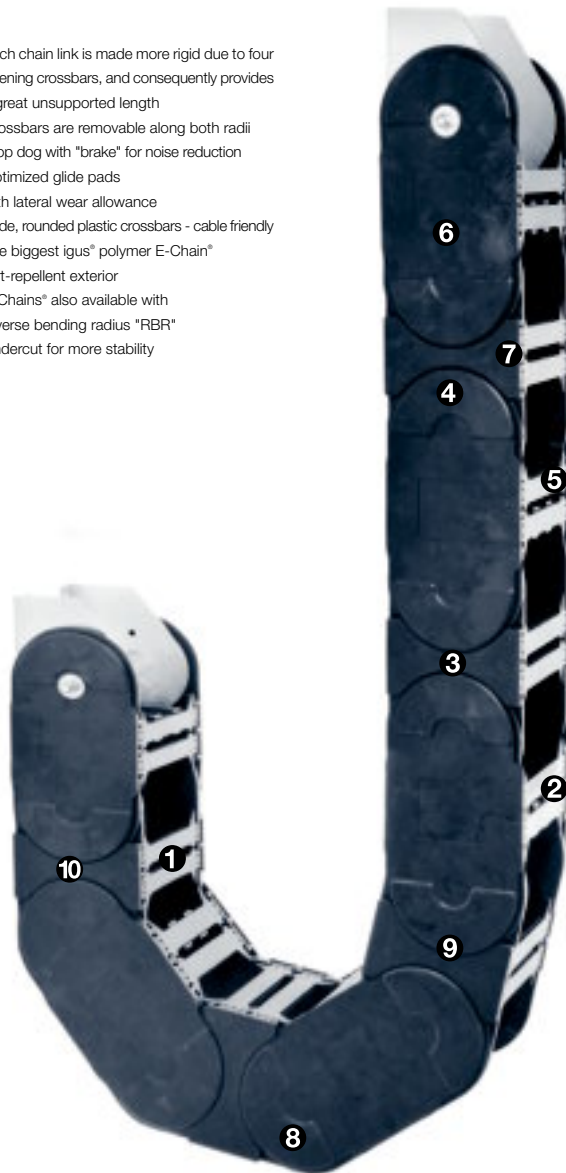

Order example complete E-Chain®

Please indicate chain-lengths or number of links **Example:** 5 m or 20 links

5 m **800.30.350.0**



E-Chain®

with 2 separators **8011** assembled every 2nd link



Interior separation

1 set **8000.1.12**



Mounting bracket



Unsupported length

FL_G = with straight upper run

FL_B = with permitted sag

Further information ► **Design, page 1.12**

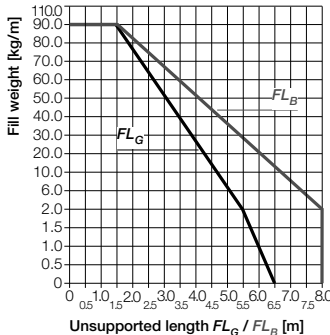
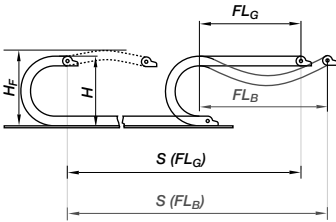

- S = Length of travel
 - R = Bending radius
 - H = Nominal clearance height
 - H_F = Required clearance height
 - H_{R1} = Trough inner height
 - D = Overlength E-Chain" radius in final position
 - $K = \pi \cdot R + \text{"safety"}$
 - D_2 = Over length - long travels, gliding
 - K_2 = "Further add-on
 - H_2 = "Mounting height
- *if the mounting bracket location is set lower

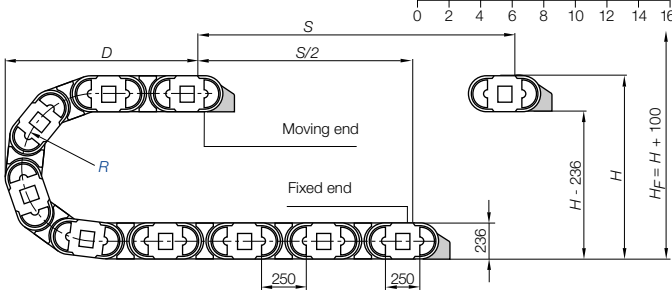

Pitch = 250 mm/link Links/m = 4 (1000 mm) Chain length = $S/2 + K$

R	325	350	400	450	500	600	750	1000
H	886	936	1036	1136	1236	1436	1736	2236
D	725	750	800	850	900	1000	1150	1400
K	1525	1600	1760	1915	2075	2385	2860	3645
H_2	*	*	*	*	*	*	*	*
D_2^{*25}	*	*	*	*	*	*	*	*
K_2	*	*	*	*	*	*	*	*

*upon request

Other installation methods

- Vertical, hanging ≤ 120 m
- Vertical, standing ≤ 6 m
- Side mounted, unsp. ≤ 6 m
- Rotary requires further calculation
- Unsupported length of upper run = upon request

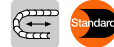

Short travels - unsupported

Unsupported E-Chains" feature positive camber over short travels. This must be accounted for when specifying the clearance height H_F . Please consult igus" if space is particularly restricted.

The required clearance height:
 $H_F = H + 100$ mm
 (with 5,0 kg/m fill weight)

Long travel lengths from 10 m to max. 450 m Chain length = $S/2 + K_2$

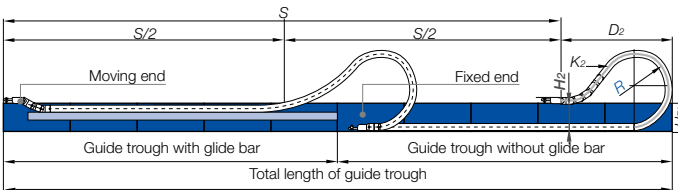

In case of travels between 4 and 10 m we recommend a longer unsupported length.



Gliding, long travel applications (max. 450 m)

In this case the E-Chain" upper run will be introduced in a guide trough on the lower run. We recommend to realize the engineering of such a plant by our technicians.

Speed / acceleration FL_G	max. 20 [m/s] / max. 200 [m/s ²]
Speed / acceleration FL_B	max. 3 [m/s] / max. 6 [m/s ²]
Gliding speed / acceleration (maximum)	max. 10 [m/s] / max. 50 [m/s ²]
Material - permitted temperature °C	igumid G / -40° up to +120° C
Flammability class, igumid G	VDE 0304 IIC UL94 HB

Technical Data



Details of material properties

► page 1.38

200

System E4/00
Inner height: 200 mm

Phone +49- (0) 22 03-96 49-800
Fax +49- (0) 22 03-96 49-222



► page 7.123

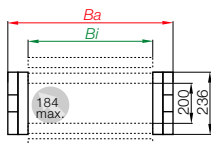

Part No. structure

800. 30. 350. 0



Series 800 - E-Chain® with crossbars every link



- E-Chains® of this size are basically used with crossbars every link
- Robust version
- Can be opened from two sides
- Removable crossbars



Part No.	<i>Bj</i> [mm]	<i>Ba</i> [mm]	Weight [kg/m]
800.20. <input type="text"/> .0	200	260	≈ 15,09
800.25. <input type="text"/> .0	250	310	≈ 15,50
800.30. <input type="text"/> .0	300	360	≈ 15,89
800.32. <input type="text"/> .0	325	385	≈ 16,05
800.35. <input type="text"/> .0	350	410	≈ 16,22
800.40. <input type="text"/> .0	400	460	≈ 16,74
800.45. <input type="text"/> .0	450	510	≈ 16,88
800.50. <input type="text"/> .0	500	560	≈ 17,23
800.55. <input type="text"/> .0	550	610	≈ 17,63
800.60. <input type="text"/> .0	600	660	≈ 18,19

Available bending radii

R [mm]
Supplement Part No. with required radius. Example: 800.30. .0

0 = standard color, other colors ► page 1.39 · Pitch = 250 mm/link - Links/m = 4

 Phone +49- (0) 22 03-96 49-800
 Fax +49- (0) 22 03-96 49-222

 igus® GmbH
 51147 Cologne

Part No. E-Chain® links, single parts

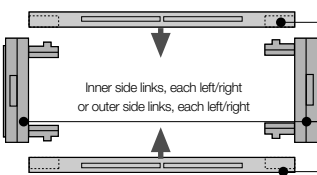
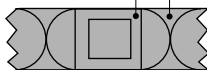
 Inner side link
 Outer side link
Single crossbar, E-Chain®, Part No. 850.*Bj*Outer side link, single part Part No. 800.01
(suitable for all radii)

Inner side link, single part Part No. 800.02

Single crossbar, E-Chain®, Part No. 850.*Bj*
 Internet: www.igus.eu
 E-mail: info@igus.de

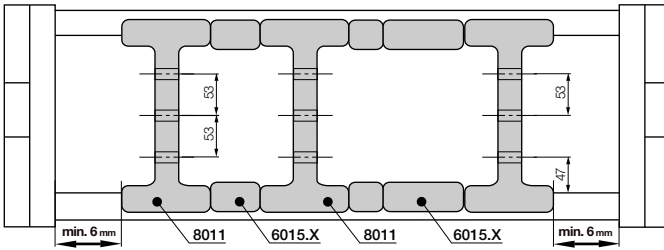

Vertical separators are used if a vertical subdivision is required. In the standard configuration, a separator is mounted at every second E-Chain® link. **Note:** Observe a lateral spacing of at least 6 mm!

Vertical separators and spacers

● Standard separator 8001 for E-Chains® offers safe stability due to its wide base design, also when used with thick cables or hoses.



Vertical separator for E-Chains*	
unassembled	8001
assembled	8011

● Separators (e.g. "side mounted") for E-Chains® can be fixed in their position with spacers 6005.XX. The available inner height will be reduced by 2 mm, per spacer and side. To avoid this, the parts can be assembled on outside of the crossbar (not for long travels) XX = width of the spacer (available 10, 15, 20 mm)



Spacer* for E-Chains*	
unassembled	6005.XX
assembled	6015.XX

*For side-mounted applications



Vertical separator 8001



Spacer 6005.XX

System E4/00
Inner height: 200 mm

Phone +49- (0) 22 03-96 49-800
Fax +49- (0) 22 03-96 49-222

Modular E4 shelving system safeguards large cables - Series 800

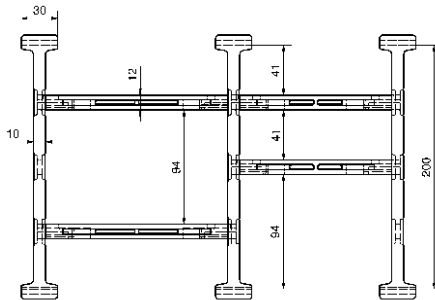

- Easy assembly
- Robust, also for large cable diameters
- Modular
- Widths from 50 to 600 mm

Part No. unassembled	Part No. assembled	Snap in tab	Part No. separator	Part No. crossbar	Width [mm]
8001H1	8011H1	single-sided	8001	450.XX	50-600
8001H2	8011H2	double-sided	8001	450.XX	50-600



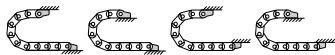

Possible installation conditions -

Further installation angles ► installation sketch

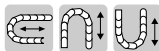
**Option steel - pivoting**

- For pivoting connections
- One part (two-piece) for all chain widths
- Electrically conductive

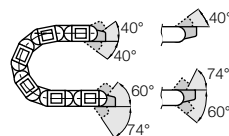
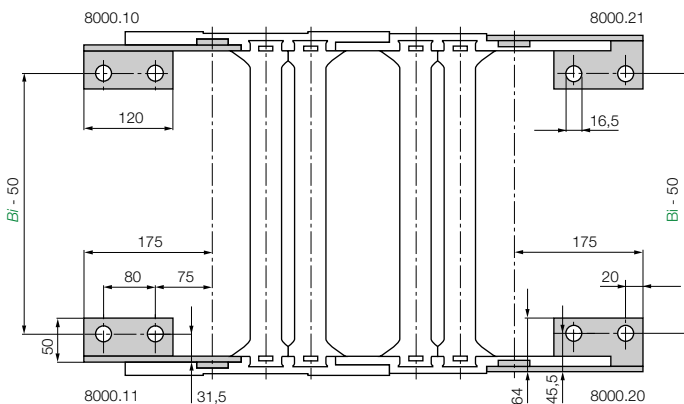
Moving end
8000.1Fixed end
8000.2Moving end
8000.1Fixed end
8000.2**Note mounting brackets:**

Depending on the E-Chain® length, the carrier will end with outer or inner side links. For the best appearance, make sure the chain ends with outer side link whenever possible. An odd number of links will always end with outer side links.

Part No. Mounting bracket

8000.1.12 Full attachment set (both sides) for E-Chain®, ending with outer side link

8000.3.12 Full attachment set (both sides) for E-Chain®, beginning with outer side link (moving end), ending with inner side link (fixed end)

8000.1 Mounting bracket set **moving end** (one side) for outer side link8000.2 Mounting bracket set **fixed end** (one side) for inner side link

E4.1 | Series 800 | Accessories | Strain Relief



Single tie-wrap plate



Shown assembled

Tie-wrap plate as individual part

As individual component screwed on KMA. Can be plugged in the mounting brackets. **Details ► chapter 10**

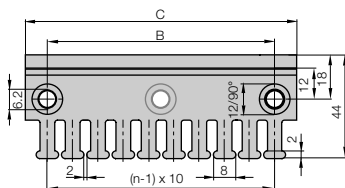

Tie-wrap plate	No. of teeth n	Dim. C [mm]	Dim. B [mm]	Center bore
3050.ZB	5	50	30	-
3075.ZB	7	75	55	-
3100.ZB	10	100	80	-
3115.ZB	11	115	95	-
3125.ZB	12	125	105	-
3150.ZB	15	150	130	-
3175.ZB	17	175	155	-
3200.ZB	20	200	180	+
3225.ZB	22	225	205	+
3250.ZB	25	250	230	+

Phone +49- (0) 22 03-96 49-800
Fax +49- (0) 22 03-96 49-222igus® GmbH
51147 CologneInternet: www.igus.eu
E-mail: info@igus.de

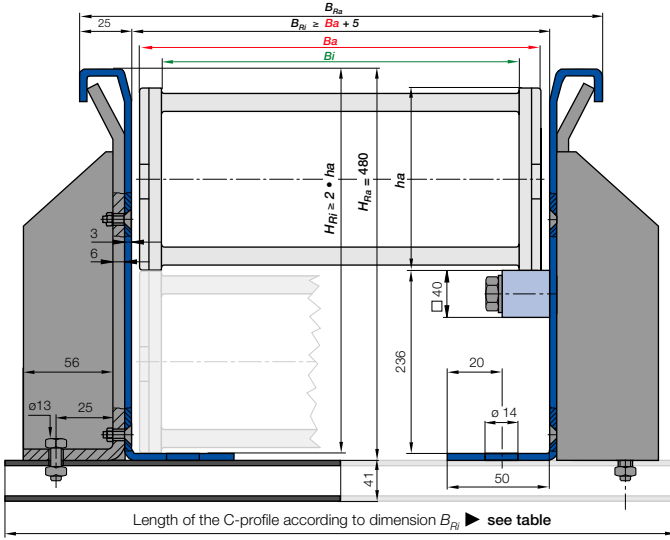

Guide troughs are used with applications where the upper run of the E-Chain® glides on the lower run. If using igus® steel guide troughs, the following components are required:

- **Guide trough without glide bars**
Part No. 90.30
- **Guide trough with glide bars**
Part No. 90.31
- **Installation sets as end connectors**
Part No. 90.50.XX

.XX indicates the length of the C-profile on which the guide trough is mounted. The values and part numbers are specified in the table on the left. Standard length of the trough components and glide bars is 2 m. The required overall length of the guide trough directly correlates to the length of travel. Special dimensions are available for confined spaces.

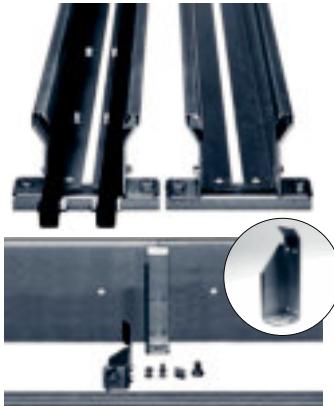

Illustration top: Guide trough with and without glide bar.

Illustration bottom: assembly kit with specially strengthened installation angle bracket for 90.30 and 90.31

- Ba** = Outer width E-Chains® / E-Tube
- Bi** = Inner width E-Chains® / E-Tube
- ha** = Outer height E-Chains® / E-Tube
- H_{Ri}** = Inner trough height
- H_{Ra}** = Outer trough height
- B_{Ri}** = Inner trough width ▶ depends on dim. Ba
- B_{Ra}** = Outer trough width
- n_{Mon}** = Number of installation sets (left/right)
- n_{Ri}** = Number of trough sets (left/right)
- ! **H_{Ri} ≥ 2 • ha**
- ! **B_{Ri} ≥ Ba + 5**
- = Guide trough set
- = Installation set
- = Glide bar
- = C-profile

Installation set with C-profile

800.20.325.0 ▶ Order example

B _{Ri}	Part No.	Installation set
.20	265	90.50.450
.25	315	90.50.500
.30	365	90.50.550
.32	390	90.50.575
.35	415	90.50.600
.40	465	90.50.650
.45	515	90.50.700
.50	565	90.50.750
.55	615	90.50.800
.60	665	90.50.850

Order example: Length of travel 30 m - Center mounted for Series 800.20.325.0 with B_{Ri} = 265

- Guide trough set (set of 2 trough side parts, incl. glide strips) **without** glide bar
Order text: 16 m Guide trough without glide bar (8 x 2 m sections) Part No. 90.30
- Guide trough set (set of 2 trough side parts, incl. glide strips) **with** glide bar
Order text: 16 m Guide trough with glide bar (8 x 2 m sections) Part No. 90.31
- Installation set "Basic" complete (Guide trough-sets + 1)
Order text: 17 Installation sets (with C-profile) Part No. 90.50.450

Principle sketch: Number of installation sets to be installed = **Number of trough sections + 1**

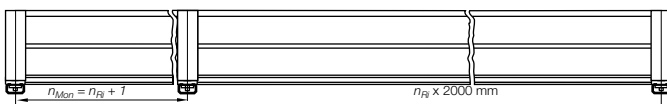



Price index



ESD classification:
Electrically conductive ESD/ATEX
version upon request



Opening E-Chains®: Remove crossbars and clips - Insert screwdriver into the slot, push down, release by lever action. Repeat action for the other side



When to use the Series 840:

- If a particularly big and stable E-Chain® is required
- At very high speeds and/or accelerations
- For long travels
- For high additional loads



When not to use it:

- If a more stable E-Chain® with identical inner height is required
- Series 800, page 7.100

- ❶ Each chain link is made more rigid due to four opening crossbars, and consequently provides a great unsupported length
- ❷ Crossbars are removable along both radii
- ❸ Stop dog with "brake" for noise reduction
- ❹ Optimized glide pads with lateral wear allowance
- ❺ Wide, rounded plastic crossbars - cable friendly
- ❻ Dirt-repellent exterior
- ❼ E-Chains® also available with reverse bending radius "RBR"
- ❽ E-Chain® available with reverse bending radii
- ❾ Undercut for more stability

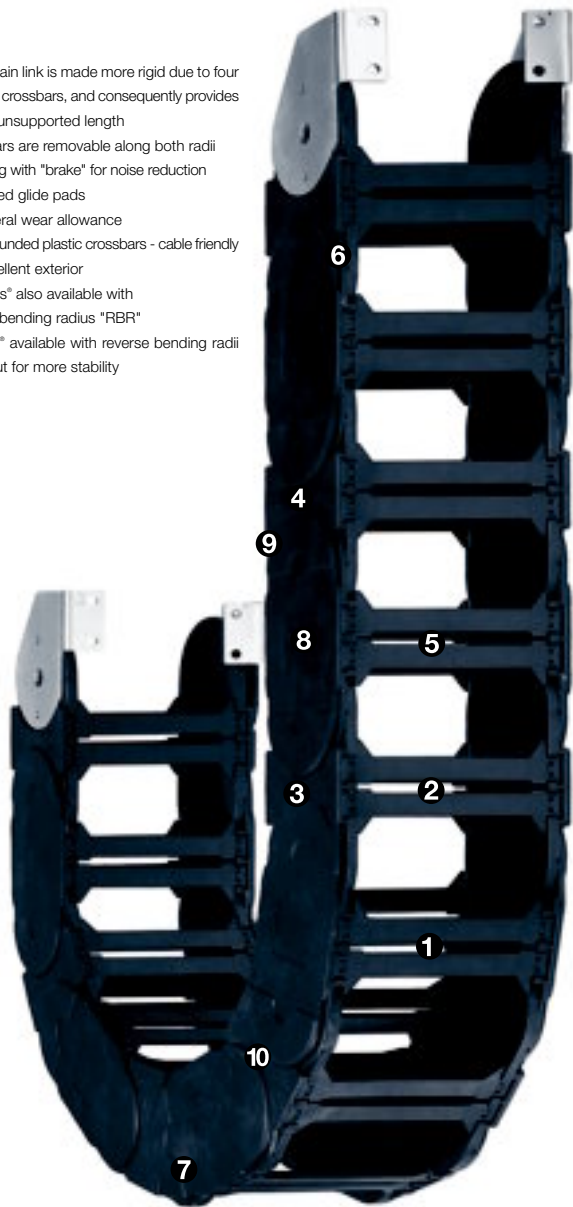

Order example complete E-Chain®

Please indicate chain-lengths or number of links Example: 7 m or 28 links

7 m 840.30.350.0



E-Chain®

with 2 separators 8411 assembled every 2nd link



Interior separation

1 set 8000.1.12



Mounting bracket



Unsupported length

FL_G = with straight upper run

FL_B = with permitted sag

Further information ► **Design, page 1.12**

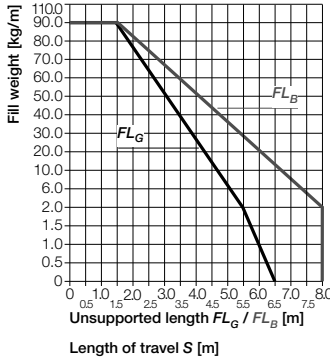
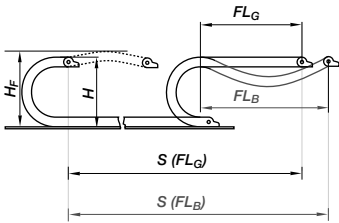

- S = Length of travel
 - R = Bending radius
 - H = Nominal clearance height
 - H_F = Required clearance height
 - H_{R1} = Trough inner height
 - D = Overlength E-Chain® radius in final position
 - $K = \pi \cdot R + \text{"safety"}$
 - D_2 = Over length - long travels, gliding
 - K_2 = *Further add-on
 - H_2 = *Mounting height
- *If the mounting bracket location is set lower

Other installation methods

- Vertical, hanging ≤ 120 m
- Vertical, standing ≤ 6 m
- Side mounted, un supp. ≤ 6 m
- Rotary requires further calculation
- Unsupported length of upper run = upon request

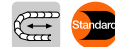

Short travels - unsupported

Unsupported E-Chains® feature positive camber over short travels. This must be accounted for when specifying the clearance height H_F . Please consult igus® if space is particularly restricted.

The required clearance height:
 $H_F = H + 100$ mm
 (with 5,0 kg/m fill weight)

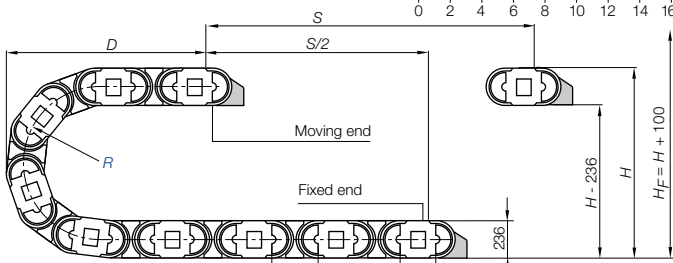

Pitch = 250 mm/link Links/m = 4 (1000 mm) Chain length = $S/2 + K$

R	325	350	400	450	500	600	750	1000
H	886	936	1036	1136	1236	1436	1736	2236
D	725	750	800	850	900	1000	1150	1400
K	1525	1600	1760	1915	2075	2385	2860	3645
H_2	*	*	*	*	*	*	*	*
D_2^{*25}	*	*	*	*	*	*	*	*
K_2	*	*	*	*	*	*	*	*

*upon request

Long travel lengths from 10 m to max. 450 m Chain length = $S/2 + K_2$

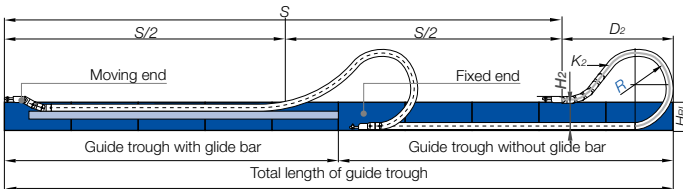

In case of travels between 4 and 10 m we recommend a longer unsupported length.



Gliding, long travel applications (max. 450 m)

In this case the E-Chain® upper run will be introduced in a guide trough on the lower run. We recommend to realize the engineering of such a plant by our technicians.

Speed / acceleration FL_G	max. 20 [m/s] / max. 200 [m/s ²]
Speed / acceleration FL_B	max. 3 [m/s] / max. 6 [m/s ²]
Gliding speed / acceleration (maximum)	max. 10 [m/s] / max. 50 [m/s ²]
Material - permitted temperature °C	igumid G / -40° up to +120° C
Flammability class, igumid G	VDE 0304 IIC UL94 HB

Technical Data



Details of material properties

► page 1.38

204

System E4/00
Inner height: 204 mm

Phone +49- (0) 22 03-96 49-800
Fax +49- (0) 22 03-96 49-222

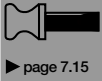
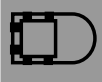

► page 7.15

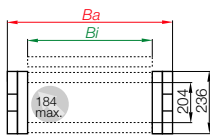

Part No. structure

840. 30. 350. 0



Series 840 - E-Chain® with crossbars every link

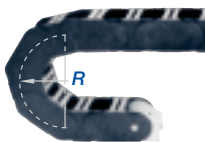

- E-Chains® of this size are basically used with crossbars every link
- Robust version
- Can be opened from two sides
- Removable crossbars



Phone +49- (0) 22 03-96 49-800
 Fax +49- (0) 22 03-96 49-222

igus® GmbH
 51147 Cologne

Internet: www.igus.eu
 E-mail: info@igus.de

Part No.	Bi [mm]	Ba [mm]	Weight [kg/m]
840.13. <input type="text"/> .0	100	160	≈ 13,84
840.15. <input type="text"/> .0	113	173	≈ 13,87
840.16. <input type="text"/> .0	125	185	≈ 13,95
840.17. <input type="text"/> .0	138	198	≈ 14,04
840.18. <input type="text"/> .0	150	210	≈ 14,13
840.20. <input type="text"/> .0	163	223	≈ 14,17
840.21. <input type="text"/> .0	175	235	≈ 14,22
840.22. <input type="text"/> .0	188	248	≈ 14,27
840.23. <input type="text"/> .0	200	260	≈ 14,35
840.25. <input type="text"/> .0	213	273	≈ 14,43
840.26. <input type="text"/> .0	225	285	≈ 14,49
840.27. <input type="text"/> .0	238	298	≈ 14,57
840.28. <input type="text"/> .0	250	310	≈ 14,61
840.30. <input type="text"/> .0	263	323	≈ 14,72
840.31. <input type="text"/> .0	275	335	≈ 14,75
840.32. <input type="text"/> .0	288	348	≈ 14,82
840.33. <input type="text"/> .0	300	360	≈ 14,91
840.35. <input type="text"/> .0	313	373	≈ 15,06
840.36. <input type="text"/> .0	325	385	≈ 15,09
840.37. <input type="text"/> .0	338	398	≈ 15,11
840.38. <input type="text"/> .0	350	410	≈ 15,15
840.40. <input type="text"/> .0	363	423	≈ 15,34
840.41. <input type="text"/> .0	375	435	≈ 15,39
840.42. <input type="text"/> .0	388	448	≈ 15,50
840.43. <input type="text"/> .0	400	460	≈ 15,57
840.45. <input type="text"/> .0	413	473	≈ 15,63
840.46. <input type="text"/> .0	425	485	≈ 15,69
840.47. <input type="text"/> .0	438	498	≈ 15,72
840.48. <input type="text"/> .0	450	510	≈ 15,80
840.50. <input type="text"/> .0	463	523	≈ 15,87
840.51. <input type="text"/> .0	475	535	≈ 15,91
840.52. <input type="text"/> .0	488	548	≈ 15,93
840.53. <input type="text"/> .0	500	560	≈ 16,00
840.55. <input type="text"/> .0	513	573	≈ 16,31
840.60. <input type="text"/> .0	563	623	≈ 16,47

Available bending radii

R [mm]

Supplement Part No. with required radius. Example: 840.30. .0

0 = standard color, other colors ▶ page 1.39 · Pitch = 250 mm/link - Links/m = 4

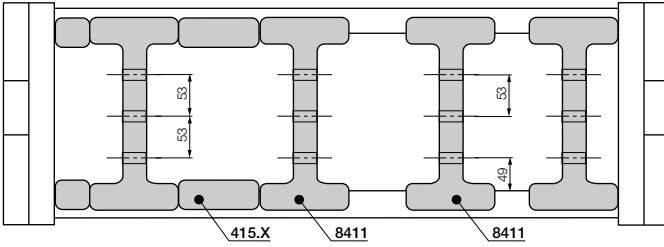

Vertical separators are used if a vertical subdivision is required. In the standard configuration, a separator is mounted at every second E-Chain® link.

Vertical separators and spacers

● Standard separator 8401 for E-Chains® offers safe stability due to its wide base design, also when used with thick cables or hoses.

● Separators (e.g. "side mounted") for E-Chains® can be fixed in their position with spacers 405.XX. The available inner height will be reduced by 2 mm, per spacer and side. To avoid this, the parts can be assembled on outside of the crossbar (not for long travels) **XX = width of the spacer** (available 10, 15, 20, 30 and 40 mm)



Vertical separator for E-Chains*	
unassembled	8401
assembled	8411



Spacer* for E-Chains*	
unassembled	405.XX
assembled	415.XX

*For side-mounted applications



Vertical separator 8401



Spacer 405.XX

System E4/00
Inner height: 204 mm

Phone +49- (0) 22 03-96 49-800
Fax +49- (0) 22 03-96 49-222



► page 7.15

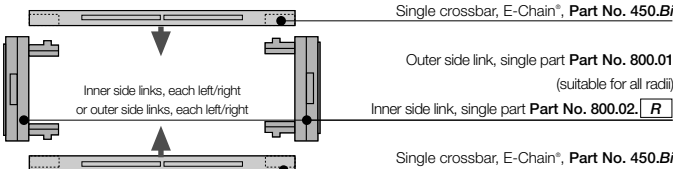

Part No. E-Chain® links, single parts

Inner side link
Outer side link

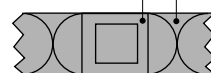

E4.1 | Series 840 | Accessories | Mounting Brackets, Steel

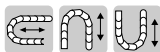

Option steel - pivoting

- For pivoting connections
- One part (two-piece) for all chain widths
- Electrically conductive

Moving end
8000.1

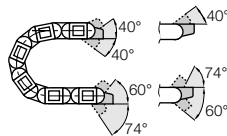

Fixed end
8000.2



Possible installation conditions -
Further installation angles ► installation sketch

Moving end
8000.1

Fixed end
8000.2

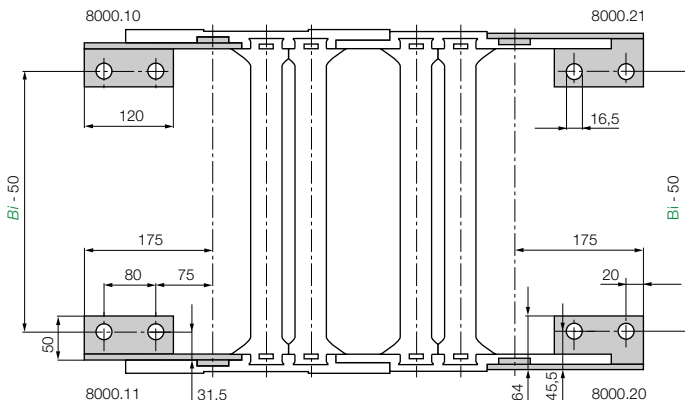

Part No. Mounting bracket

- 8000.1.12 Full attachment set (both sides) for E-Chain®, ending with outer side link
- 8000.3.12 Full attachment set (both sides) for E-Chain®, beginning with outer side link (moving end), ending with inner side link (fixed end)
- 8000.1 Mounting bracket set **moving end** (one side) for outer side link
- 8000.2 Mounting bracket set **fixed end** (one side) for inner side link

Note mounting brackets:

Depending on the E-Chain® length, the carrier will end with outer or inner side links. For the best appearance, make sure the chain ends with outer side link whenever possible. An odd number of links will always end with outer side links.

E4.1 | Series 840 | Accessories | Strain Relief



Tiewrap plate as individual part

As individual component screwed on KMA. Can be plugged in the mounting brackets. **Details ► chapter 10**

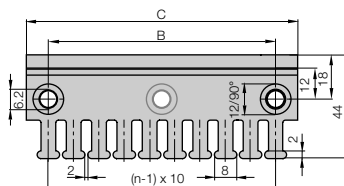
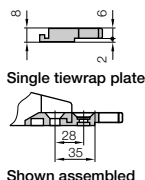

Tiewrap plate	No. of teeth n	Dim. C [mm]	Dim. B [mm]	Center bore
3050.ZB	5	50	30	-
3075.ZB	7	75	55	-
3100.ZB	10	100	80	-
3115.ZB	11	115	95	-
3125.ZB	12	125	105	-
3150.ZB	15	150	130	-
3175.ZB	17	175	155	-
3200.ZB	20	200	180	+
3225.ZB	22	225	205	+
3250.ZB	25	250	230	+

(- = no / + = yes)

Phone +49- (0) 22 03-96 49-800
Fax +49- (0) 22 03-96 49-222

igus® GmbH
51147 Cologne

Internet: www.igus.eu
E-mail: info@igus.de

Price index

 Very high fill weights
 possible > 100 kg/m

 Very huge interior
 (inner height 350 mm,
 inner width up to 1000 mm)

- 1 The world's largest* all-plastic E-Chain®
(*issue 10/2008, available from 2009)
- 2 Predestined to carry thick,
heavy and stiff cables and hoses
- 3 Ideal for rough use on oil platforms, in steel plants,
or in heavy duty machinery
- 4 Maintenance-free - no grease
or oil needed to lubricate the joints
- 5 Very high stiffness, high strength at
shear forces due to the "undercut"
- 6 Modular design saves assembly time
- 7 Highly resistant to wear, corrosion and sea water
- 8 Easy lengthening and shortening
- 9 Plastic material reduces noise
- 10 Electrically insulating
- 11 Interior separation available
- 12 Stainless steel (AISI 304)
mounting brackets available
- 13 Straight run due to the inner/outer link principle
- 14 Solid crossbars made from high-tech polymer

When to use the Series E4.350:

- If a maintenance-free Offshore E-Chain® is required
- If no use of oil and grease is needed
- If electrical insulation is necessary
- If a resistance to corrosion and sea water is required
- If 100% plastics is the first choice for your application

Order example complete E-Chain®

 Please indicate chain-lengths or number of links **Example: 5 m or 10 links**

 5 m **E4.350.200.500.0**
E-Chain®

 with 2 separators **350.1** assembled every 2nd link

 Interior separation

 1 set **E4.350100.1.12**
Mounting bracket

Unsupported length

FL_G = with straight upper run

FL_B = with permitted sag

Further information ► Design, page 1.12

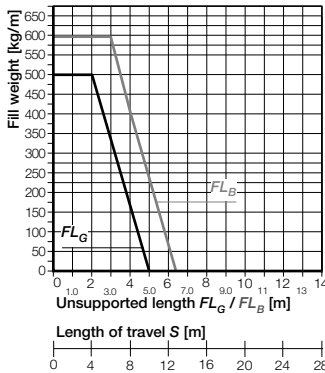
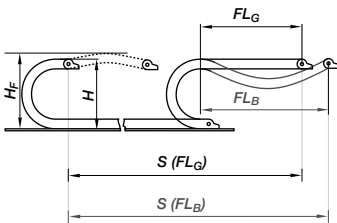

- S = Length of travel
- R = Bending radius
- H = Nominal clearance height
- H_F = Required clearance height
- H_{R1} = Trough inner height
- D = Overlength E-Chain® radius in final position
- $K = \pi \cdot R + \text{"safety"}$

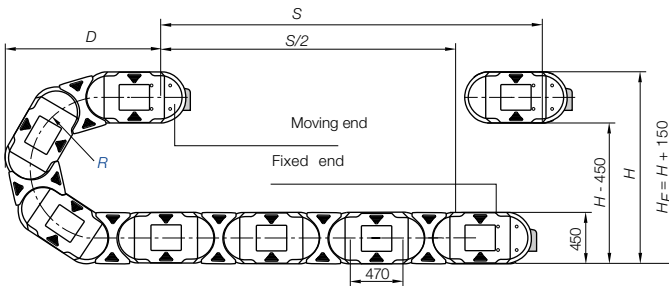

Short travels - unsupported

Unsupported E-Chains® feature positive camber over short travels. This must be accounted for when specifying the clearance height H_F . Please consult igus® if space is particularly restricted.

Pitch = 470 mm/link Links/m = 2 (940 mm) Chain length = $S/2 + K$

R	500	750	1000
H_{R1}	1450	1950	2450
D	1195	1445	1695
K	2515	3300	4085

The required clearance height:
 $H_F = H + 150 \text{ mm}$

Technical Data



Details of material properties

► page 1.38

Material - permitted temperature °C	igumid G / -40° up to +120° C
Flammability class, igumid G	VDE 0304 IIC UL94 HB



System E4.1
Inner height: 350 mm

Phone +49- (0) 22 03-96 49-800
Fax +49- (0) 22 03-96 49-222



► page 7.15

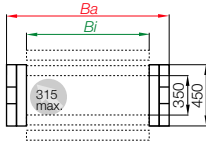

Part No. structure

E4.350.200.500.0



Series E4.350- E-Chain® with crossbars every link

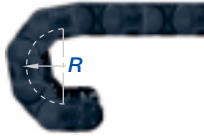

- Crossbars every link
- For rigid hydraulic hoses
- For applications particularly demanding
- Can be opened from two sides



Phone +49- (0) 22 03-96 49-800
 Fax +49- (0) 22 03-96 49-222

igus® GmbH
 51147 Cologne

Internet: www.igus.eu
 E-mail: info@igus.de

Part No.	<i>Bi</i> [mm]	<i>Ba</i> [mm]	E4.350 [kg/m]
E4.350.200. <input type="text"/> .0	200	340	upon request
E4.350.300. <input type="text"/> .0	300	440	upon request
E4.350.400. <input type="text"/> .0	400	540	upon request
E4.350.500. <input type="text"/> .0	500	640	upon request
E4.350.750. <input type="text"/> .0	750	890	upon request
E4.350.1000. <input type="text"/> .0	1000	1140	upon request

Available bending radii

R [mm]

Supplement Part No. with required radius. Example: E4.350.200..0

0 = standard color, other colors ► page 1.39 - Pitch: 111 mm/link - Links/m = 9

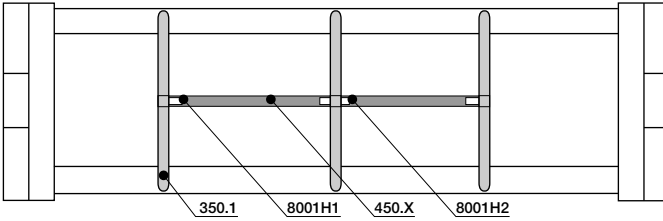

Vertical separators

- Vertical separator 350.1 for use with horizontal crossbar 450.X.

Width X [mm]	Part No. unassembled	Part No. assembled	Width X [mm]	Part No. unassembled	Part No. assembled
200	450.20	451.20	500	450.50	451.50
300	450.30	451.30	750	450.75	451.75
400	450.40	451.40	1000	450.100	451.100

Vertical separator for E-Chains*	
unassembled	350.1
assembled	351.1

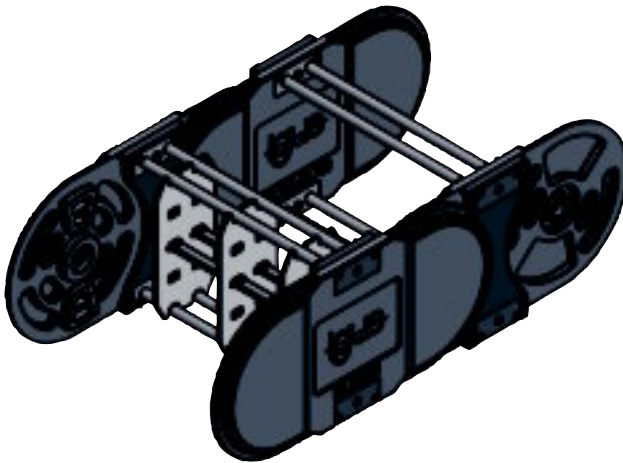

Heavy duty interior separation for cable-safe guidance

System E4.1
Inner height: 350 mm

Phone +49- (0) 22 03-96 49-800
Fax +49- (0) 22 03-96 49-222



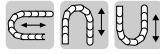

Option steel

- For pivoting connections
- One part (two-piece) for all E-Chain® widths
- Electrically conductive
- Stainless steel (AISI 304) version available

Moving end
E4.350100.1

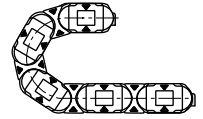

Fixed end
E4.350100.1

Dimensions and order configurations

Moving end
E4.350100.1

Fixed end
E4.350100.1

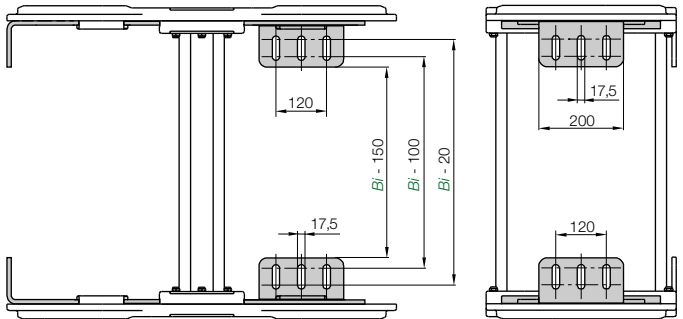

Note mounting brackets:

Depending on the E-Chain® length, the carrier will end with outer or inner side links. For the best appearance, make sure the E-Chain® ends with outer side link whenever possible. An odd number of links will always end with outer side links.

Part No.	Mounting bracket
E4.350100.1.12	Full attachment set (both sides) for E-Chain®, ending with outer side link
E4.350100.1	Mounting bracket set (one side) for outer side link

Phone +49- (0) 22 03-96 49-800
Fax +49- (0) 22 03-96 49-222

igus® GmbH
51147 Cologne

Internet: www.igus.eu
E-mail: info@igus.de



Stainless steel (AISI 304)
mounting brackets for heavy
duty applications-standard

System E4.1
Inner height: 350 mm

Phone +49- (0) 22 03-96 49-800
Fax +49- (0) 22 03-96 49-222



► page 7.15



A close-up photograph of a dark blue car wheel, showing the tire tread and the hub. A white arrow points from the left towards the center of the wheel. The background is a solid yellow color.

hooks.

claws.

E4/light

E4/light - light, stable and cost-effective

E4/light - The "light" features appear in two places: A reduced thickness of the side links (for all types), and a thinner crossbar (for some types: 14240, 14340). Weight reduction, a large interior space and price reduction result as well as a compromise in strength. E4/light E-Chains® achieve optimum price-performance solutions for many industries. Especially for unsupported short travels, hanging and short standing designs. E4/light types are often first choice.

Typical industries and applications

- Machine tools
- Material handling
- Stone cutting machines
- Woodworking machines
- General machinery
- Vehicles
- Construction machinery
- Limited long travel applications



Special equipment: Electrically conductive
ESD/ATEX version upon request



Side-mounted -
unsupported



High torsional
rigidity



System E4 -
4-piece design link

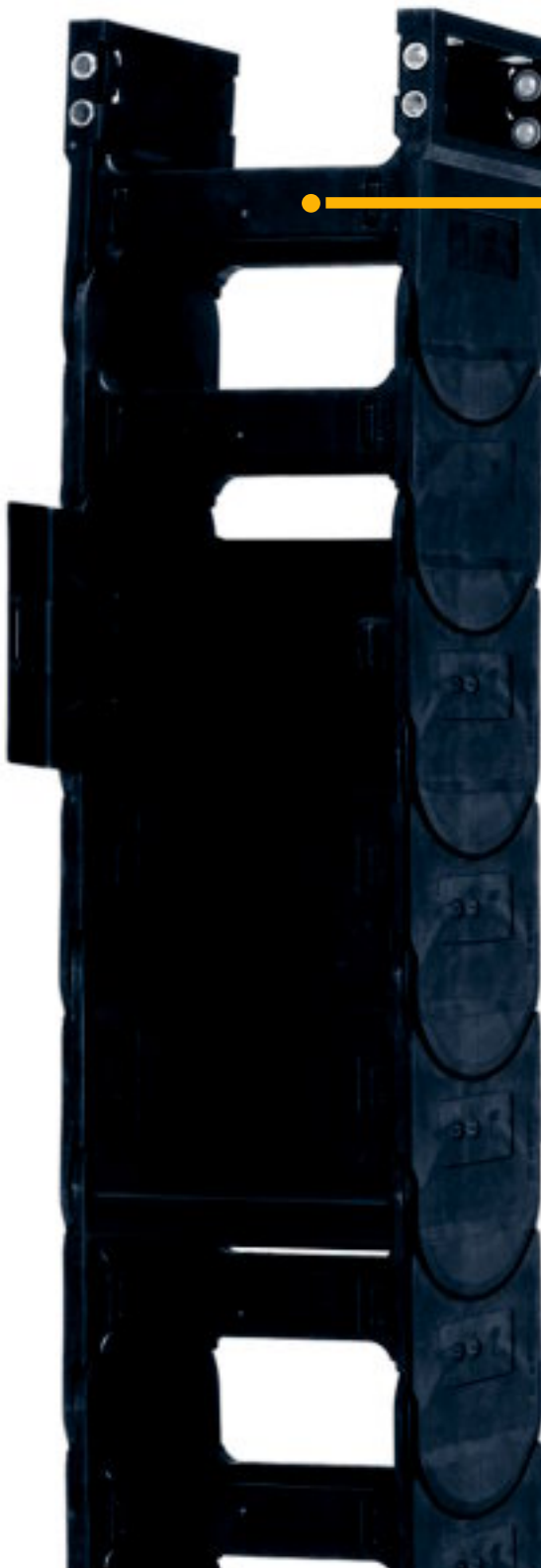



E4/light E-Chains® and E-Tubes are ideal in Machine Tools



E4/light is popular for hanging applications



With the space-saving igus® E4 Polymer E-Chains® the overall dimension for the installation for this crane system was considerably reduced

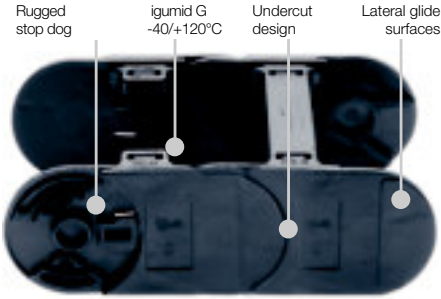

E4/light version with the approved E4/4 Series undercut design

- Low weight
- Optimized ratio of Interior and exterior dimension
- Cost-effective
- Numerous interior separation possibilities
- Broad system of modular accessories
- Narrow outer links
- Max. travel: 150 - 250 m
- You can find more technical data about the material, chemical resistance, temperatures ► **Design, from page 1.38**

Selection table

Series	Inner height <i>hi</i> [mm]	Inner width <i>Bi</i> [mm]	Outer width <i>Ba</i> [mm]	Outer height <i>ha</i> [mm]	Bending radius <i>R</i> [mm]	Unsupported length max. [m]	page
--------	--------------------------------	-------------------------------	-------------------------------	--------------------------------	---------------------------------	-----------------------------	------

Crossbars every link for particularly demanding applications



14040	56	50 - 600	76 - 626	84	135 - 500	4,0	7.124
14240	62	50 - 400	76 - 426	84	135 - 500	4,0	7.134
15050	80	50 - 600	80 - 630	108	150 - 500	4,6	7.144

Crossbars every 2nd link for almost all applications



14140	56	50 - 600	76 - 626	84	135 - 500	4,0	7.124
14340	62	50 - 400	76 - 426	84	135 - 500	4,0	7.134
15150	80	50 - 600	80 - 630	108	150 - 500	4,6	7.144

E-Tubes fully enclosed, excellent cable protection



R18840	56	75 - 462	101 - 489	84	150 - 500	4,0	7.124
R19850	80	75 - 462	105 - 493	108	200 - 500	4,6	7.144

System E4/light | E-Chains® and E-Tubes | **Assembling**



Position at one side...



...and snap in



Position opposite side, press together and snap in



Assemble crossbars - Push down and snap in by using a screwdriver



Assemble clips (E-Chains® with crossbars every other link) - Push down and snap in



Assemble E-Tube lids/bottoms - Attach to the connector at an angle - Snap in

System E4/light | E-Chains® and E-Tubes | **Separating**



Remove crossbars, clips, and lids on two adjacent chain links. Guide the screwdriver into the slot between side links and release it by levering it and separate the E-Chain®



E-Chains® | **Opening**



Remove crossbars - Insert screwdriver into the slot, push down, release by lever action

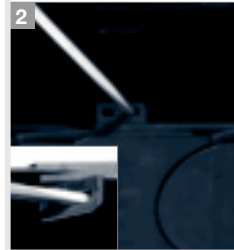

Remove clips - Insert screwdriver into the slot and push down, release by lever action

E-Tubes | **Opening**



Remove lids/bottoms - Insert screwdriver into the slot, release by lever action

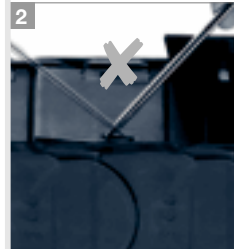

Release only one side to swivel the lid



You can find an assembly video on the web ► www.igus.de/en/e4_assembly

Price index



Series 14040 Series 14140 Series R18840



ESD classification:

Electrically conductive ESD/ATEX version upon request



High torsional rigidity



Side-mounted - unsupported



Opening E-Chains: Remove crossbars and clips - Insert screwdriver into the slot, push down, release by lever action



Remove lids/bottoms (E-Tubes) - Insert screwdriver into the slot, release by lever action



When to use the Series 14040/14140/R18840:

- For achieving simple, economical solutions
- For minimizing a chain's external width at any given internal width
- For use if Series 400 proves too large



When not to use it:

- If a quieter version is required
▶ Series E4.56, page 7.62
- If long side-mounted, unsupported length is required
▶ Series E4.56, page 7.62

- 1 Crossbars on E-Chains® are removable along both radii
- 2 Hinged snap-open removable lids along outer radius of E- Tube
- 3 Closed and open styles can be combined
- 4 Lateral glide surfaces for side-mounted operation
- 5 Wide, rounded plastic crossbars - cable friendly
- 6 Removable lids along inner radius
- 7 Locking or pivoting mounting brackets available
- 8 KMA mounting brackets with attachment points on all sides
- 9 Integrated strain relief possible
- 10 Stronger version with undercut design
- 11 E-Chains® also available with reverse bending radius "RBR"

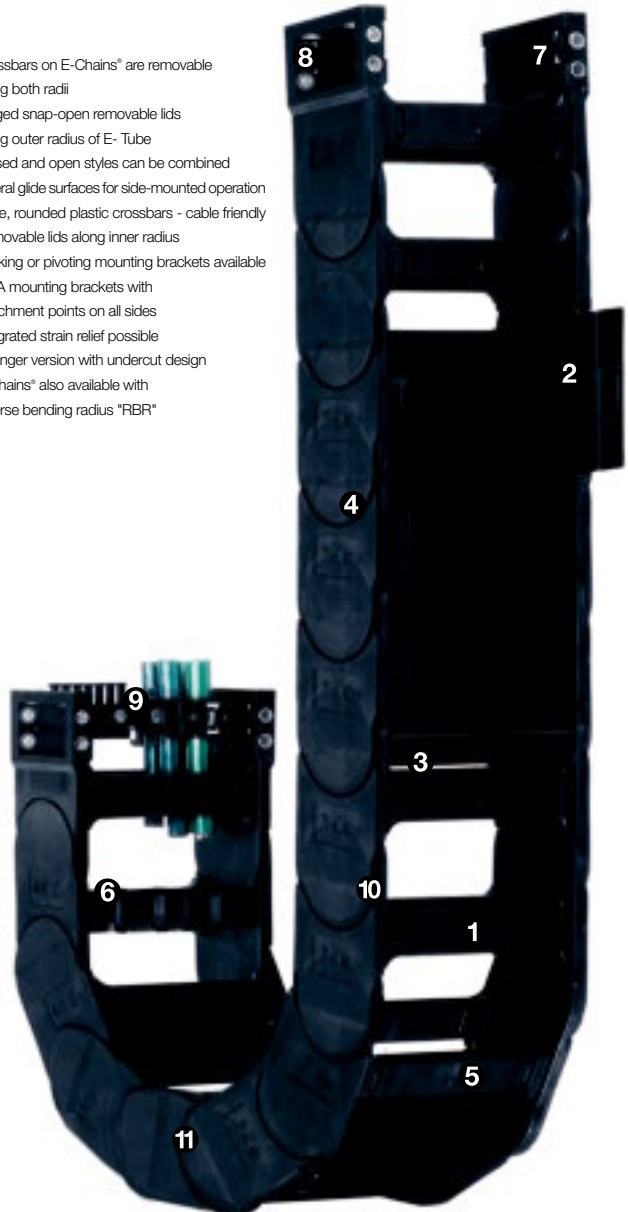

Order example complete E-Chain®

Please indicate chain-lengths or number of links Example: 5 m or 55 links

5 m 14040.30.300.0

E-Chain®

with 2 separators 411 assembled every 2nd link

Interior separation

1 set 141400.30.12.C

Mounting bracket



Unsupported length

FL_G = with straight upper run

FL_B = with permitted sag

Further information ► Design, page 1.12

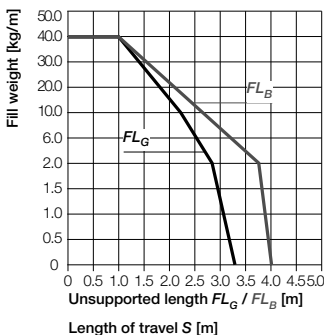
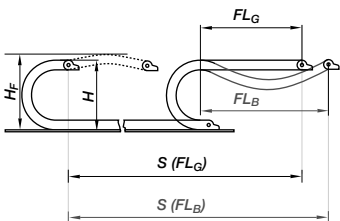

- S = Length of travel
 - R = Bending radius
 - H = Nominal clearance height
 - H_F = Required clearance height
 - H_{R1} = Trough inner height
 - D = Overlength E-Chain" radius in final position
 - $K = \pi \cdot R + \text{"safety"}$
 - D_2 = Over length - long travels, gliding
 - K_2 = "Further add-on
 - H_2 = "Mounting height
- *if the mounting bracket location is set lower

Other installation methods

- Vertical, hanging ≤ 80 m
- Vertical, standing ≤ 6 m
- Side mounted, un supp. ≤ 2 m
- Rotary requires further calculation
- Unsupported length of upper run = upon request



Short travels - unsupported

Unsupported E-Chains" feature positive camber over short travels. This must be accounted for when specifying the clearance height H_F . Please consult igus" if space is particularly restricted.

The required clearance height:

$H_F = H + 50$ mm
(with 2,0 kg/m fill weight)

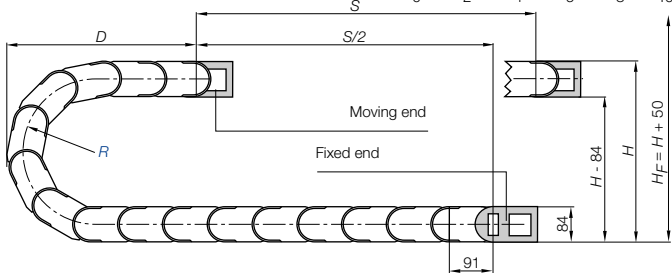

Pitch = 91 mm/link Links/m = 11 (1001 mm) Chain length = $S/2 + K$

R	135	150	175	200	250	300	400	500
H_{25}^0	360	385	435	485	585	685	885	1085
D	270	285	310	335	385	435	535	635
K	650	750	825	900	1050	1225	1450	1775
H_2	266	266	266	266	266	266	266	266
D_{25}^{+25}	390	450	530	710	920	1120	1530	1830
K_2	728	819	1001	1274	1638	1911	2548	3185

Long travel lengths from 10 m to max. 150 m Chain length = $S/2 + K_2$

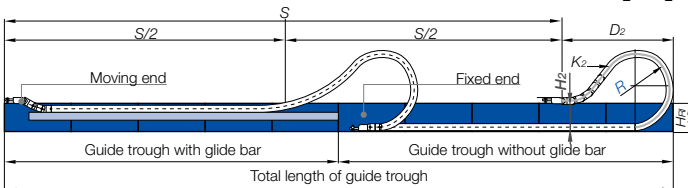

In case of travels between 4 and 10 m we recommend a longer unsupported length.



Gliding, long travel applications (max. 150 m)

In this case the E-Chain" upper run will be introduced in a guide trough on the lower run. We recommend to realize the engineering of such a plant by our technicians.

Speed / acceleration FL_G	max. 20 [m/s] / max. 200 [m/s]
Speed / acceleration FL_B	max. 3 [m/s] / max. 6 [m/s]
Gliding speed / acceleration (maximum)	max. 10 [m/s] / max. 50 [m/s]
Material - permitted temperature °C	igumid G / -40° up to +120° C
Flammability class, igumid G	VDE 0304 IIC UL94 HB

Technical Data



Details of material properties

► page 1.38

56

System E4/light
Inner height: 56 mm

Phone +49- (0) 22 03-96 49-800
Fax +49- (0) 22 03-96 49-222



► page 7.123

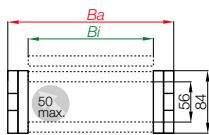

Part No. structure

14040.13.250.0



Series 14040 - E-Chain® with crossbars every link

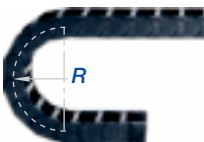

- Crossbars every link
- For rigid hydraulic hoses
- For applications particularly demanding
- Can be opened from two sides

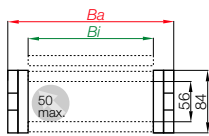

Part No. structure

14140.13.250.0



Series 14140 - E-Chain® with crossbars every 2nd link

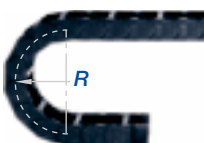

- Crossbars every 2nd link = Standard
- For nearly every situation
- Can be opened from two sides
- Easy assembly
- Stable
- Attractive price

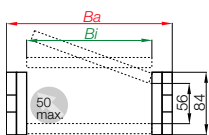

Part No. structure

18840.25.250.0



Series R18840 - Fully enclosed E-Tube



- Fully enclosed
- Excellent cable protection against dirt
- Protection against hot chips (up to 900°C)
- Lids along the entire inner radius are completely removable. Lids along the entire outer radius are single sided snap-open with a hinge on the other side to keep them attached to the chain or completely removable.



Part No.	<i>Bi</i>	<i>Ba</i>	14040	14140	R18840	
	[mm]	[mm]	[kg/m]	[kg/m]	[kg/m]	
14040/14140.05.	.0	50	76	≈ 2,66	≈ 2,48	-
14040/14140.06.	.0	65	91	≈ 2,47	≈ 2,51	-
14040/14140/18840.07.	.0*	75	101	≈ 2,75	≈ 2,25	≈ 3,20
14040/14140.08.	.0	87	113	≈ 2,84	≈ 2,44	-
14040/14140/18840.10.	.0	100	126	≈ 2,93	≈ 2,61	≈ 3,49
14040/14140.11.	.0	112	139	≈ 3,06	≈ 2,67	-
14040/14140/18840.12.	.0	125	151	≈ 3,12	≈ 2,71	≈ 3,85
14040/14140.13.	.0	137	164	≈ 3,26	≈ 2,77	-
14040/14140/18840.15.	.0	150	176	≈ 3,32	≈ 2,81	≈ 4,28
14040/14140.16.	.0	162	189	≈ 3,43	≈ 2,86	-
14040/14140/18840.17.	.0	175	201	≈ 3,54	≈ 2,92	≈ 4,54
14040/14140.18.	.0	187	214	≈ 3,65	≈ 2,97	-
14040/14140/18840.20.	.0	200	226	≈ 3,67	≈ 2,98	≈ 4,85
14040/14140.21.	.0	212	239	≈ 3,78	≈ 3,04	-
14040/14140.22.	.0	225	251	≈ 3,85	≈ 3,07	-
14040/14140.23.	.0	237	264	≈ 3,98	≈ 3,14	-
14040/14140/18840.25.	.0	250	276	≈ 4,07	≈ 3,18	≈ 5,58
14040/14140.26.	.0	262	289	≈ 4,16	≈ 3,22	-
14040/14140/18840.27.	.0	275	301	≈ 4,27	≈ 3,28	≈ 5,85
14040/14140.28.	.0	287	314	≈ 4,29	≈ 3,29	-
14040/14140/18840.30.	.0	300	326	≈ 4,51	≈ 3,40	≈ 6,24
14040/14140.31.	.0	312	339	≈ 4,57	≈ 3,42	-
14040/14140.32.	.0	325	351	≈ 4,60	≈ 3,44	-
14040/14140.33.	.0	337	364	≈ 4,77	≈ 3,53	-
14040/14140/18840.35.	.0	350	376	≈ 4,93	≈ 3,61	≈ 6,99
14040/14140.36.	.0	362	389	≈ 4,94	≈ 3,61	-
14040/14140.37.	.0	375	401	≈ 4,95	≈ 3,62	-
14040/14140.38.	.0	387	414	≈ 5,04	≈ 3,66	-
14040/14140/18840.40.	.0	400	426	≈ 5,24	≈ 3,76	≈ 7,94
14040/14140.41.	.0	412	439	≈ 5,39	≈ 3,84	-
14040/14140.42.	.0	425	451	≈ 5,54	≈ 3,92	-
14040/14140.43.	.0	437	464	≈ 5,61	≈ 3,95	-
14040/14140.45.	.0	450	476	≈ 5,68	≈ 3,98	-
14040/14140/18840.46.	.0	462	489	≈ 5,70	≈ 3,99	≈ 8,40
14040/14140.47.	.0	475	501	≈ 5,83	≈ 4,06	-
14040/14140.48.	.0	487	514	≈ 5,86	≈ 4,08	-
14040/14140.50.	.0	500	526	≈ 5,96	≈ 4,13	-
14040/14140.51.	.0	512	539	≈ 5,98	≈ 4,14	-
14040/14140.52.	.0	525	551	≈ 6,03	≈ 4,16	-
14040/14140.53.	.0	537	564	≈ 6,18	≈ 4,24	-
14040/14140.55.	.0	550	576	≈ 6,67	≈ 4,48	-
14040/14140.60.	.0	600	626	≈ 6,98	≈ 4,58	-

Hot Chips up to 850°C

E-Tubes that repel hot chips, up to 850°C. Some applications, depending on amount and size of the chips, can burn or melt the surface. That is no longer the case with the igus® "igumid HT" material. Order example:

Full E-Tube made of HT:
18840.40.150.0.HT
Lids made of HT:
18840.40.HTE.150.0

*for long travels. Upon request.
Further information:
www.igus.de/en/HT
Delivery time
up to 4 weeks!



System E4/light
Inner height: 56 mm

Phone +49- (0) 22 03-96 49-800
Fax +49- (0) 22 03-96 49-222

Available bending radii

R [mm] 135 150 175 200 250 300 400 500

Supplement Part No. with required radius. Example: 14040.30.300.0

0 = standard color, other colors ▶ page 1.39 · Pitch = 91 mm/link · Links/m = 11

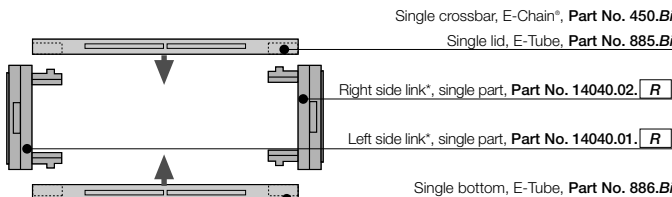

* Removable lid only, no hinged option

** not available for R18840



Extender crossbar for large diameter hoses ▶ page 7.130

Part No. E-Chain® - links, single parts

*View from the fixed point of the E-Chain®/E-Tube

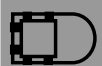

▶ page 7.123



Vertical separators are used if a vertical subdivision is required. In the standard configuration, a separator is mounted at every second link. **Note:** Observe a lateral spacing of at least 16 mm!

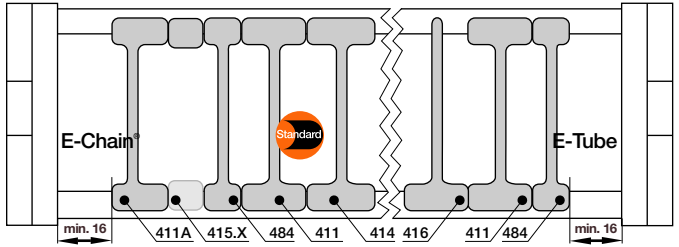

Vertical separator

401



Vertical separator

483



Spacer

405.XX



Locking separator

404



Vertical separator

406



Asymmetric separator

401A



Vertical separator

for E-Chains®/E-Tubes

unassembled 401

assembled 411



Vertical separator

for E-Chains®/E-Tubes

unassembled 483

assembled 484



Spacer*

for E-Chains®

unassembled 405.XX

assembled 415.XX



Locking separator

for E-Chains®

unassembled 404

assembled 414



Vertical separator

for E-Tubes

unassembled 406

assembled 416



Asymmetric separator

for E-Chains®

unassembled 401A

assembled 411A



*For side-mounted applications

Option 1: Vertical separators and spacers

● **Standard separator 401 for E-Chains®/E-Tubes** offers safe stability due to its broad foot design, also when used with thick cables or hoses.

● **Vertical separator 483 with a narrow foot for E-Chains® and E-Tubes** with applications where a large number of small cables need to be individually separated.

● Separators (e.g. "side mounted") for E-Chains® can be fixed in their position with **Spacers 405.XX**. The available inner height will be reduced by 2 mm, per spacer and side. To avoid this, the parts can be assembled on outside of the crossbar (not for long travels) **XX = width of the spacer** (available 10, 15, 20, 30 and 40 mm)

Additionally:

● **Locking separator for E-Chains® 404** - with increased retention force for applications exposed to very high humidity or extreme loads. The extra retention force is achieved by asymmetric claws for the crossbar. Ensure proper alignment

● **Locking separator 406 for E4-Tubes** - safe fitting locked on lid or bottom of the Tube and sideways slideable. The opposing lid or bottom can easily be opened and closed. Especially capable if many separators need to be assembled on a tight inner width.

● **Asymmetric separator 401A for E-Chains®** with an 18 mm base, for combinations between spacers of different widths and vertical separators in side-mounted applications, for instance.

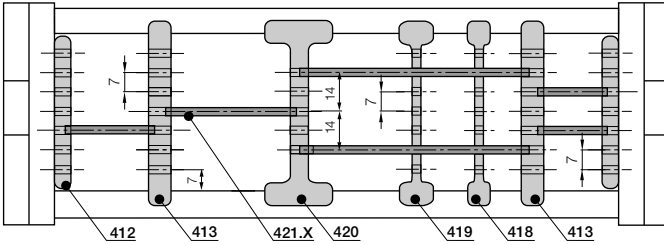

For use with many cables of differing diameters. E-Chains® and E-Tubes can be subdivided both vertically and horizontally. The shelves can be arranged elevator-shifted with different bottoms

Option 2: Shelves

● Side plates 402, middle plates 403 and shelves 420.X form the basic pattern of a shelf system. Shelves of various widths can be arranged at 7 different heights (in 7 mm increments).

● Locking vertical separator 410, slotted combined with shelves (only for E-Chains®).

● Slotted separators 408 are used for very fine subdivisions. However, they cannot be retrofitted into an existing separation system without dismantling the interior separators first.

● The unilateral open slotted separator 409 can be retrofitted into an existing interior separation system without a need for dismantling the interior separators. During an installation of open slotted separators, the top and bottom notches cannot be occupied by shelves.

Side plate for E-Chains®/E-Tubes	
unassembled	402
assembled	412

Middle plate for E-Chains®/E-Tubes	
unassembled	403
assembled	413

Locking vertical separator for E-Chains®	
unassembled	410
assembled	420

Slotted separator for E-Chains®/E-Tubes	
unassembled	408
assembled	418

Open slotted separator for E-Chains®/E-Tubes	
unassembled	409
assembled	419

Width X [mm]	Part No. unassembled	Part No. assembled	Width X [mm]	Part No. unassembled	Part No. assembled
018	420.18	421.18	075	420.75	421.75
023	420.23	421.23	088	420.88	421.88
025	420.25	421.25	100	420.100	421.100
028	420.28	421.28	125	420.125	421.125
033	420.33	421.33	150	420.150	421.150
043	420.43	421.43	175	420.175	421.175
050	420.50	421.50	187	420.187	421.187
062	420.62	421.62	200	420.200	421.200



Side plate 402

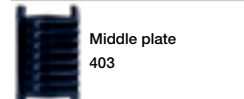

Middle plate 403

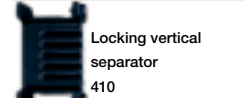

Locking vertical separator 410

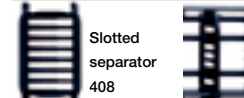

Slotted separator 408

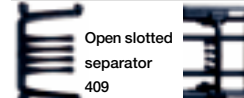

Open slotted separator 409



Shelf 420.X

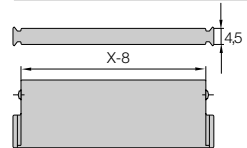

Additional elements for interior separation

Center crossbar	
unassembled	405
assembled	415

Center crossbar - for applications with a large number of thin cables. The center crossbar offers the option of subdividing the E-Chain® independently into upper and lower halves.

Rollclip	
unassembled	489.27
assembled	490.27

Rollclip - minimizes abrasion of particularly sensitive hoses - simply clamped onto the opening crossbar. The movable rollers compensate for relative movement between the chain and hose.

Roller separator	
unassembled	429
assembled	430

Roller separator - performs a similar function to the Rollclip, but doubles as a separator.





Extension links - for extremely wide E-Chains® up to 3,0 m

- For applications in which particularly high fill weights necessitate extremely wide E-Chains® (up to 3000 mm)
- The extension link design allows virtually limitless side-by-side attachment of chains
- The unsupported length of a chain can be increased when additional loads are required
- Extension links can be used with E-Chains®, E-Tubes or as a combination of both
- They are suitable for unsupported and gliding applications in a guide trough
- E-Chains® with extension links are attached with KMA or steel mounting brackets

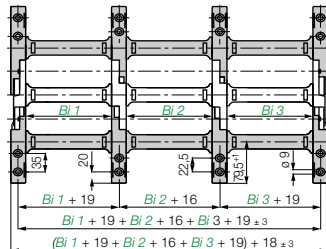

Part No. structure

14040.10 /20 /10. 0

14040.Bi1/Bi2/Bi3. 0



Extender crossbars - careful guide of hoses applications

- Suitable for hoses with a maximum outer diameter of 245 mm
- Gliding operation with crossbars assembled along the outer radius and a special guide trough
- Gliding operation not guaranteed with crossbars assembled along the inner radius
- The extender crossbar can either be attached to the side links directly or can be used in combination with two stranded snap-open crossbars

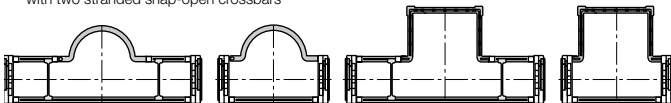

Consult igus® for your extender crossbar applications. We are happy to assist you with your design layout

Round extender crossbar with snap-open crossbars Attached directly to the side link Square extender crossbar with snap-open crossbars Attached directly to the side link

Part No.	Max Ø [mm] hose	Form	Installation side link	Combination with snap-open crossb.
450.15.RHD115	115	○	-	+
450.17.RD115	115	○	+	-
450.25.D150	150	□	+	-
450.30.D200	180	□	+	-
450.35.D250	195	□	+	-
450.40.D300	245	□	+	-
450.20.HD150	150	□	-	+
450.25.HD200	180	□	-	+
450.30.HD250	195	□	-	+

○ = round □ = square + = yes / - = no



E4 clip-on cable binder

- For side-mounted applications ● Serves as a clip-on, lateral guide for hoses and cables on E-Chains®
- The loops can be adjusted as required ● Compatible with many E4 E-Chains® ● Stylish and economical
- One clip and one locking band are needed for each chain link ● Call us if you have any questions on project planning

Part No.	Form
450.B12	Locking clip, comprising a locking element
450.B12.200	Locking band, comprising a locking element and band; 12 x 1,5 x 200 mm

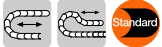

The Standard - Option KMA* - pivoting

- Recommended for unsupported and gliding applications
- Confined installation conditions
- Option - integrated C-profile strain relief device with Chainfix clip or strain relief tiwrap plates
- Corrosion resistant
- Universal mountable with attachment capability on all sides

*KMA = Polymer Metal Mounting Bracket

Moving end

141400/189400...2

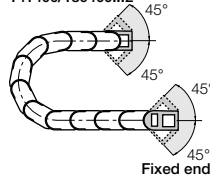

Fixed end

141400/189400...1



The attachment variants arising automatically by the choice of the KMA mounting bracket

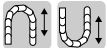
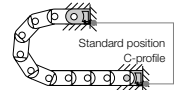

Option KMA - locking

- Recommended for vertical hanging / standing applications

Additionally:

- Universal mountable
- C-profile option
- Corrosion resistant
- Locked connections
- At very high acceleration

Moving end

140400/188400...2

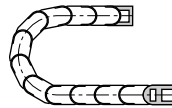

Fixed end

140400/188400...1



The attachment variants arising automatically by the choice of the KMA mounting bracket

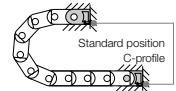

Moving end

141400/189400...2 (pivoting)
140400/188400...2 (locking)

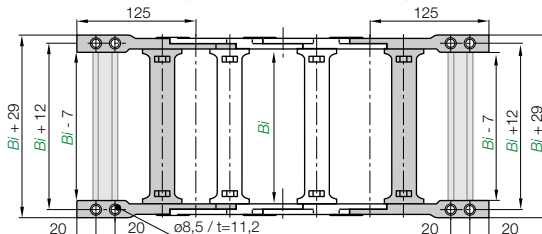

Fixed end

(pivoting) 141400/189400...1
(locking) 140400/188400...1

Dimensions and order configurations

Part No. structure (pivoting)

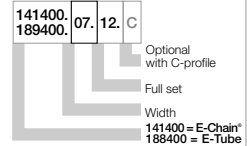

Part No. structure (locking)

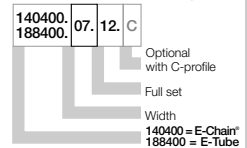

index	Part No. full set		C-profile option [mm]	Bi	index	Part No. full set		C-profile option [mm]	Bi
	pivoting	locking				pivoting	locking		
.05.	▶ 141400	140400	05.12	50	.31.	▶ 141400	140400	31.12	312
.06.	▶ 141400	140400	06.12	65	.32.	▶ 141400	140400	32.12	325
.07.	▶ 141400/189400	140400/188400	07.12	75	.33.	▶ 141400	140400	33.12	337
.08.	▶ 141400	140400	08.12	87	.35.	▶ 141400/189400	140400/188400	35.12	350
.10.	▶ 141400/189400	140400/188400	10.12	100	.36.	▶ 141400	140400	36.12	362
.11.	▶ 141400	140400	11.12	112	.37.	▶ 141400	140400	37.12	375
.12.	▶ 141400/189400	140400/188400	12.12	125	.38.	▶ 141400	140400	38.12	387
.13.	▶ 141400	140400	13.12	137	.40.	▶ 141400/189400	140400/188400	40.12	400
.15.	▶ 141400/189400	140400/188400	15.12	150	.41.	▶ 141400	140400	41.12	412
.16.	▶ 141400	140400	16.12	162	.42.	▶ 141400	140400	42.12	425
.17.	▶ 141400/189400	140400/188400	17.12	175	.43.	▶ 141400	140400	43.12	437
.18.	▶ 141400	140400	18.12	187	.45.	▶ 141400	140400	45.12	450
.20.	▶ 141400/189400	140400/188400	20.12	200	.46.	▶ 141400/189400	140400/188400	46.12	462
.21.	▶ 141400	140400	21.12	212	.47.	▶ 141400	140400	47.12	475
.22.	▶ 141400	140400	22.12	225	.48.	▶ 141400	140400	48.12	487
.23.	▶ 141400	140400	23.12	237	.50.	▶ 141400	140400	50.12	500
.25.	▶ 141400/189400	140400/188400	25.12	250	.51.	▶ 141400	140400	51.12	512
.26.	▶ 141400	140400	26.12	262	.52.	▶ 141400	140400	52.12	525
.27.	▶ 141400/189400	140400/188400	27.12	275	.53.	▶ 141400	140400	53.12	537
.28.	▶ 141400	140400	28.12	287	.55.	▶ 141400	140400	55.12	550
.30.	▶ 141400/189400	140400/188400	30.12	300	.60.	▶ 141400	140400	60.12	600

Full set, for both ends:

141400. [05. 12]

Single-part order:

141400. [05. 2]

Mounting bracket moving end

141400. [05. 1]

Mounting bracket fixed end

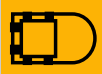



igus® Chainfix steel clamps and Chainfix stainless-steel clamps - max. pull forces, adjustable with hexagon socket. Available as single, double or triple clamps. **Details ► chapter 10**

Chainfix clamps for the C-profile

Part No. single clamps		Part No. double clamps		Part No. triple clamps		Cable
steel	stainless steel	steel	stainless steel	steel	stainless steel	ø [mm]
CFX12.1	CFX12.1.E	CFX12.2	CFX12.2.E	CFX12.3	-	06 - 12
CFX14.1	CFX14.1.E	CFX14.2	CFX14.2.E	CFX14.3	-	12 - 14
CFX16.1	CFX16.1.E	CFX16.2	CFX16.2.E	CFX16.3	-	14 - 16
CFX18.1	CFX18.1.E	CFX18.2	CFX18.2.E	CFX18.3	-	16 - 18
CFX20.1	CFX20.1.E	CFX20.2	CFX20.2.E	CFX20.3	-	18 - 20
CFX22.1	CFX22.1.E	CFX22.2	CFX22.2.E	CFX22.3	-	20 - 22
CFX26.1	CFX26.1.E	CFX26.2	CFX26.2.E	-	-	22 - 26
CFX30.1	CFX30.1.E	CFX30.2	CFX30.2.E	-	-	26 - 30
CFX34.1	CFX34.1.E	CFX34.2	CFX34.2.E	-	-	30 - 34
CFX38.1	CFX38.1.E	-	-	-	-	34 - 38
CFX42.1	CFX42.1.E	-	-	-	-	38 - 42



Chainfix Clip - Modular snap-on strain relief device for C-profile

Available for all igus® E-ChainSystems® with C-profiles and also suitable for assembly in the KMA mounting brackets and clip-on strain relief for crossbars. High pull forces, plug-in modular snap-on strain relief device. **Details ► chapter 10**

Cable ø [mm]	Part No. clamp	Part No. bottom part
04 - 08	CFC-08-M	CFC-08-C
08 - 12	CFC-12-M	CFC-12-C
12 - 16	CFC-16-M	CFC-16-C
16 - 20	CFC-20-M	CFC-20-C
20 - 24	CFC-24-M	CFC-24-C



Chainfix Nugget for the C-Profile

Strain relief for the fixation of cables up to a diameter of Ø 30 mm. Easy to assemble, without any screws and tools. Easy strain relief due to fixation with pre-harnessed cable strap, very small space requirement. **Details ► chapter 10**

Part No.	ø max. conduit [mm]	Width [mm]
CFN.20	20	10,8
CFN.30.52	30	16,8
CFN.20.N35	20	20,0

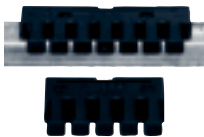

Chainfix tiwrap plates with clip-on connection for the C-profile

Can be plugged into the KMA C-profile. Easy to assemble without any screws. Easily solvable with screwdriver nevertheless safe stop. For all E-Chains® with KMA and integrated C-profile. **Details ► chapter 10**

Part No.	Width of strain relief [mm]	Number of teeth
3050.ZC	50	5
3075.ZC	75	7



Tiwrap plate as individual part

As individual component screwed on KMA. Can be plugged in the mounting brackets. **Details ► chapter 10**

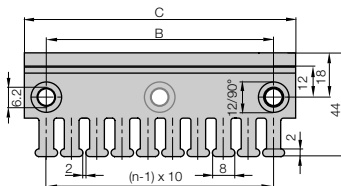
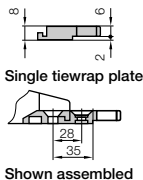

Tiwrap plate	No. of teeth n	Dim. C [mm]	Dim. B [mm]	Center bore
3050.ZB	5	50	30	-
3075.ZB	7	75	55	-
3100.ZB	10	100	80	-
3115.ZB	11	115	95	-
3125.ZB	12	125	105	-
3150.ZB	15	150	130	-
3175.ZB	17	175	155	-
3200.ZB	20	200	180	+
3225.ZB	22	225	205	+
3250.ZB	25	250	230	+

(- = no / + = yes)

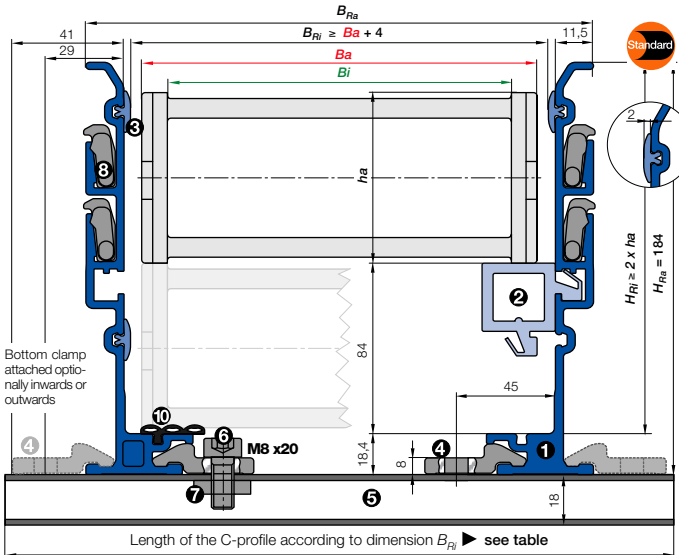

- B_a = Outer width E-Chains* / E-Tube
- B_i = Inner width E-Chains* / E-Tube
- h_a = Outer height E-Chains* / E-Tube
- H_{Ri} = Inner trough height
- H_{Ra} = Outer trough height
- B_{Ri} = Inner trough width ▶ depends on dim. B_a
- B_{Ra} = Outer trough width
- n_{Mon} = Number of installation sets (left/right)
- n_{Rl} = Number of troughs sets (left/right)
- $H_{Rl} \geq 2 \cdot h_a$
- $B_{Rl} \geq B_a + 4$
- = Guide trough set ● = Glide bar
- = Installation set "Basic" ● = C-profile

Installation set "Basic" with C-profile

Bottom Clamp attached optionally inwards or outwards

14040, 95.200.0 ▶ Order example

B_{Ri} [mm]	Part No.	
	attached inwards	attached outwards
.05	80	-
.06	95	-
.07	105	-
.08	117	960.50.175
.10	130	960.50.200
.11	143	960.50.200
.12	155	960.50.225
.13	168	960.50.225
.15	180	960.50.250
.16	193	960.50.250
.17	205	960.50.275
.18	218	960.50.275
.20	230	960.50.300
.21	243	960.50.300
.22	255	960.50.325
.23	268	960.50.325
.25	280	960.50.350
.26	293	960.50.350
.27	305	960.50.375
.28	318	960.50.375
.30	330	960.50.400
.31	343	960.50.400
.32	355	960.50.425
.33	368	960.50.425
.35	380	960.50.450
.36	393	960.50.450
.37	405	960.50.475
.38	418	960.50.475
.40	430	960.50.500
.41	443	960.50.500
.42	455	960.50.525
.43	468	960.50.525
.45	480	960.50.550
.46	493	960.50.550
.47	505	960.50.575
.48	518	960.50.575
.50	530	960.50.600
.51	543	960.50.600
.52	555	960.50.625
.53	568	960.50.625
.55	580	960.50.650
.60	630	960.50.700



- **Components, trough "Basic":** ① Trough side parts, aluminum, 2 m ② Glide bar, plastic, 2 m ③ Glide strips, plastic, 2 m (without glide strips on request) ⑩ Optional: Silencer profile, rubber
- **Components, installation set "Basic":** ④ Bottom clamp, aluminum ⑤ C-profile, steel galvanized ⑥ Screw M8 x20 ⑦ Sliding nut M8 ⑧ Interface connector, plastic

Order example: Length of travel 30 m - Center mounted for Series 14040.10.200.0 with $B_{Ri} = 130$

- Guide trough set (set of 2 trough side parts, incl. glide strips) **without** glide bar
Order text: 16 m guide trough without glide bar (8 x 2 m sections) Part No. **974.30.SL**
- Guide trough set (set of 2 trough side parts, incl. glide strips) **with** glide bar
Order text: 16 m guide trough with glide bar (8 x 2 m sections) Part No. **974.31.SL**
- Installation set "Basic" complete (guide trough-sets + 1)
Order text: 17 installation sets "Basic" Part No. **960.50.200**
- Module for the fixed end
Order text: 1 set Part No. **974.81**
- Option:** For an additional noise dampening with silencer profile, please add Index A - Example:
Part No. 974.30.SLA

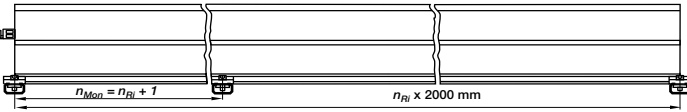

Principle sketch: Number of installation sets to be installed = Number of trough sections + 1

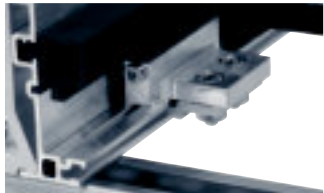

A quick fix for mounting the stationary end of an E-Chain®
 With this module for the fixed end, fast and easy mounting onto the Aluminum "SuperTrough" is now possible without any drilling. Fast mounting of the E-Chain® by clamping onto the aluminum trough

- Quick relocation of the stationary end
- No drilling necessary ▶ [page 9.16](#)

Insert for the installation set "Heavy-Duty": **974.50.XXX** instead of (960.50.XXX) on the right column "attached outwards"

Phone +49- (0) 22 03-96 49-800
 Fax +49- (0) 22 03-96 49-222

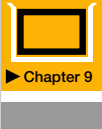

Price index



Series 14240 Series 14340



ESD classification:

Electrically conductive ESD/ATEX
version upon requestHigh torsional
rigiditySide-mounted -
unsupported

Opening E-Chains®: Remove crossbars and clips - Insert screwdriver into the slot, push down, release by lever action



When to use the Series 14240/14340:

- For achieving simple, economical solutions
- For achieving the ideal ratio between internal and external dimensions
- For use if Series 400 proves too large



When not to use it:

- If a quieter version is required
 - ▶ Series E4.56, page 7.62
- If long side-mounted, unsupported length is required
 - ▶ Series E4.56, page 7.62
- If an increased inner height is required
 - ▶ Series 15050, page 7.144

- 1 Crossbars on E-Chains® are removable along both radii
- 2 Wide, rounded plastic crossbars - cable friendly
- 3 Optimum ratio of inner height to outer height
- 4 Lateral glide surfaces for side-mounted operation
- 5 Integrated strain relief possible
- 6 Locking or pivoting mounting brackets available
- 7 KMA mounting brackets with attachment points on all sides
- 8 Stronger version with undercut design
- 9 Numerous interior separation possibilities
- 10 E-Chains® also available with reverse bending radius "RBR"

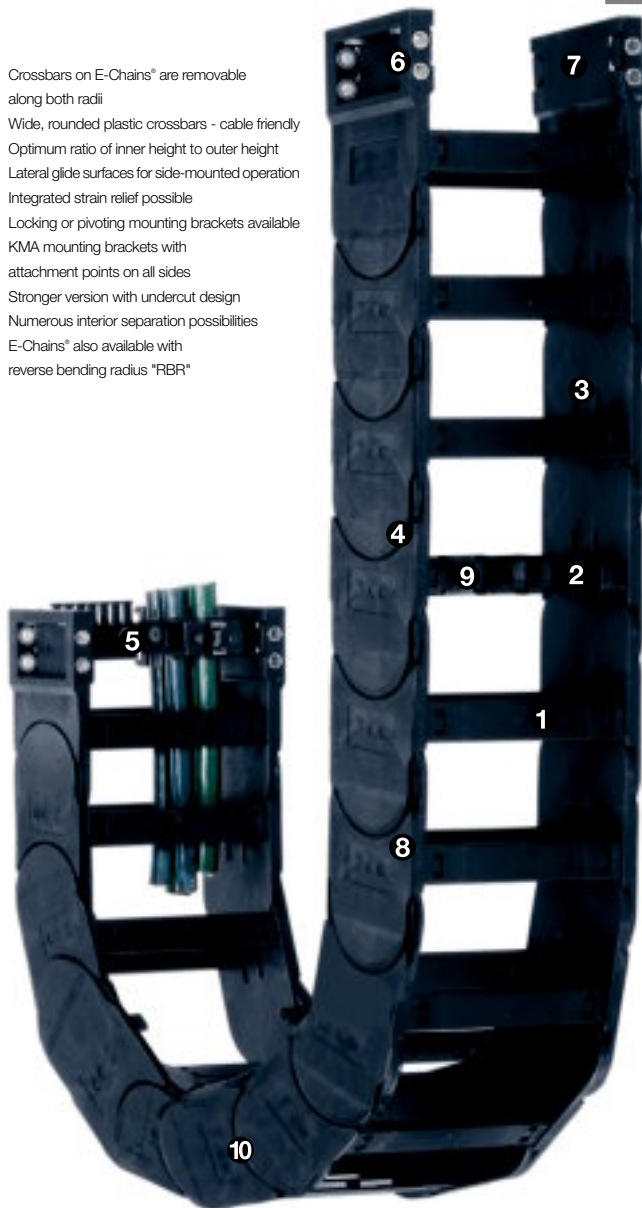

Order example complete E-Chain®

Please indicate chain-lengths or number of links Example: 6 m or 66 links

6 m 14240.30.300.0



E-Chain®

with 2 separators 417 assembled every 2nd link

Interior separation

1 set 142400.30.12.C



Mounting bracket



Unsupported length

FL_G = with straight upper run

FL_B = with permitted sag

Further information ► **Design, page 1.12**

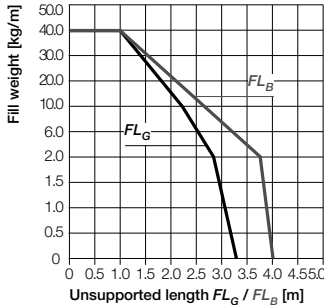
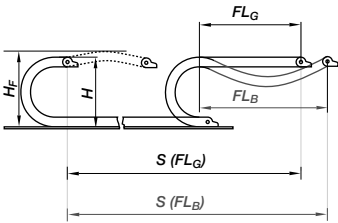

- S = Length of travel
 - R = Bending radius
 - H = Nominal clearance height
 - H_F = Required clearance height
 - H_{R1} = Trough inner height
 - D = Overlength E-Chain" radius in final position
 - $K = \pi \cdot R + \text{"safety"}$
 - D_2 = Over length - long travels, gliding
 - K_2 = "Further add-on
 - H_2 = "Mounting height
- *if the mounting bracket location is set lower

Other installation methods

- Vertical, hanging ≤ 80 m
- Vertical, standing ≤ 6 m
- Side mounted, un supp. ≤ 2 m
- Rotary requires further calculation
- Unsupported length of upper run = upon request

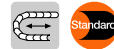

Short travels - unsupported

Unsupported E-Chains" feature positive camber over short travels. This must be accounted for when specifying the clearance height H_F . Please consult igus" if space is particularly restricted.

The required clearance height:

$H_F = H + 50$ mm
(with 2,0 kg/m fill weight)

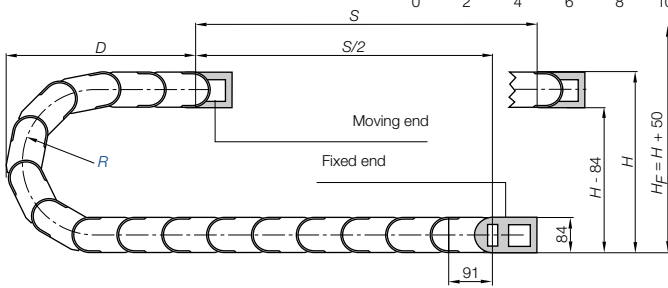

Pitch = 91 mm/link Links/m = 11 (1001 mm) Chain length = $S/2 + K$

R	135	150	175	200	250	300	400	500
$H_{2,25}^0$	360	385	435	485	585	685	885	1085
D	270	285	310	335	385	435	535	635
K	650	750	825	900	1050	1225	1450	1775
H_2	266	266	266	266	266	266	266	266
$D_{2,25}^{+25}$	390	450	550	710	920	1120	1530	1850
K_2	728	819	1001	1274	1638	1911	2548	3185

Long travel lengths from 10 m to max. 150 m Chain length = $S/2 + K_2$

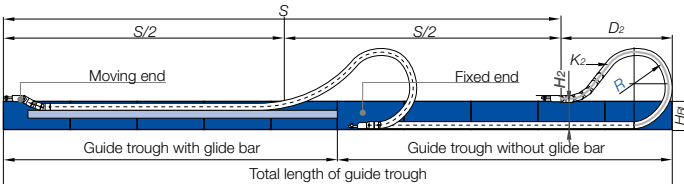

In case of travels between 4 and 10 m we recommend a longer unsupported length.



Gliding, long travel applications (max. 150 m)

In this case the E-Chain" upper run will be introduced in a guide trough on the lower run. We recommend to realize the engineering of such a plant by our technicians.

Technical Data

Speed / acceleration FL_G	max. 20 [m/s] / max. 200 [m/s]
Speed / acceleration FL_B	max. 3 [m/s] / max. 6 [m/s]
Gliding speed / acceleration (maximum)	max. 10 [m/s] / max. 50 [m/s]
Material - permitted temperature °C	igumid G / -40° up to +120° C
Flammability class, igumid G	VDE 0304 IIC UL94 HB



Details of material properties

► page 1.38



System E4/light
Inner height: 62 mm

Phone +49- (0) 22 03-96 49-800
Fax +49- (0) 22 03-96 49-222



► page 7.123

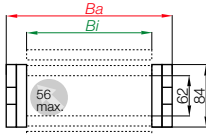

Part No. structure

14240.12.250.0



Series 14240 - E-Chain® with crossbars every link

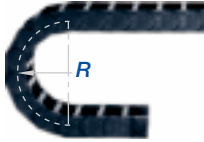

- Crossbars every link
- For rigid hydraulic hoses
- For applications particularly demanding
- Can be opened from two sides

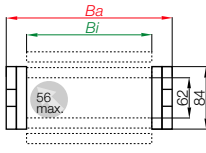

Part No. structure

14340.12.250.0



Series 14340 - E-Chain® with crossbars every 2nd link

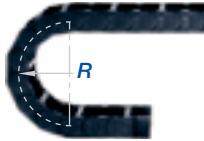

- Crossbars every 2nd link = Standard
- For nearly every situation
- Can be opened from two sides
- Easy assembly
- Stable
- Attractive price



Part No.	<i>Bi</i>	<i>Ba</i>	14240	14340
	[mm]	[mm]	[kg/m]	[kg/m]
14240/14340.05.	50	76	≈ 2,37	≈ 2,32
14240/14340.06.	68	94	≈ 2,40	≈ 2,33
14240/14340.07.	75	101	≈ 2,42	≈ 2,34
14240/14340.087.	87	114	≈ 2,47	≈ 2,36
14240/14340.10.	100	126	≈ 2,52	≈ 2,39
14240/14340.11.	108	134	≈ 2,55	≈ 2,40
14240/14340.112.	112	139	≈ 2,55	≈ 2,41
14240/14340.12.	125	151	≈ 2,62	≈ 2,44
14240/14340.137.	137	164	≈ 2,66	≈ 2,46
14240/14340.15.	150	176	≈ 2,72	≈ 2,49
14240/14340.162.	162	189	≈ 2,73	≈ 2,49
14240/14340.17.	168	194	≈ 2,79	≈ 2,52
14240/14340.18.	175	201	≈ 2,82	≈ 2,53
14240/14340.187.	187	214	≈ 2,84	≈ 2,55
14240/14340.20.	200	226	≈ 2,89	≈ 2,58
14240/14340.212.	212	239	≈ 2,95	≈ 2,60
14240/14340.23.	225	251	≈ 3,01	≈ 2,63
14240/14340.237.	237	264	≈ 3,04	≈ 2,65
14240/14340.25.	250	276	≈ 3,10	≈ 2,68
14240/14340.262.	262	289	≈ 3,11	≈ 2,69
14240/14340.28.	275	301	≈ 3,19	≈ 2,72
14240/14340.29.	287	314	≈ 3,20	≈ 2,73
14240/14340.30.	300	326	≈ 3,30	≈ 2,78
14240/14340.312.	312	339	≈ 3,31	≈ 2,79
14240/14340.325.	325	351	≈ 3,37	≈ 2,81
14240/14340.337.	337	364	≈ 3,40	≈ 2,83
14240/14340.350.	350	376	≈ 3,56	≈ 2,91
14240/14340.362.	362	389	≈ 3,61	≈ 2,93
14240/14340.375.	375	401	≈ 3,64	≈ 2,95
14240/14340.387.	387	414	≈ 3,69	≈ 2,97
14240/14340.400.	400	426	≈ 3,73	≈ 2,99

Available bending radii

R [mm] 135 150 175 200 250 300 400 500

Supplement Part No. with required radius. Example: 14240.12.250.0

0 = standard color, other colors ▶ page 1.39 · Pitch = 91 mm/link - Links/m = 11



Extender crossbar for large diameter hoses ▶ page 7.140

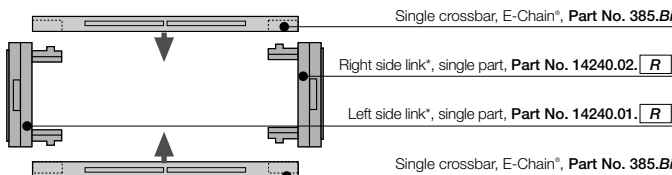

Part No. E-Chain® - links, single parts

*View from the fixed point





Vertical separators are used if a vertical subdivision is required. In the standard configuration, a separator is mounted at every second link.

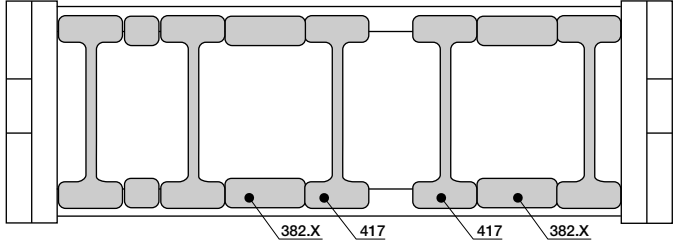

Vertical separator
407



Spacer
381.XX

Vertical separator for E-Chains®	
unassembled	407
assembled	417



Spacer* for E-Chains®	
unassembled	381.XX
assembled	382.XX



*For side-mounted applications

Option 1: Vertical separators and spacers

- Standard separator 407 for E-Chains® offers safe stability due to its wide base design, also when used with thick cables or hoses.

- Separators (e.g. "side mounted") for E-Chains® can be fixed in their position with Spacers 381.XX. The available inner height will be reduced by 2 mm, per spacer and side. To avoid this, the parts can be assembled on outside of the crossbar (not for long travels)
XX = width of the spacer (available 10, 15, 20 mm)

Phone+49- (0) 22 03-96 49-800
Fax +49- (0) 22 03-96 49-222

igus® GmbH
51147 Cologne

Internet: www.igus.eu
E-mail: info@igus.de

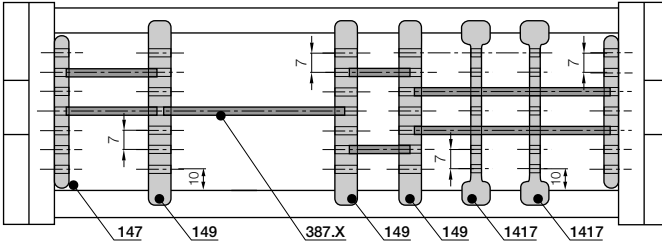

For use with many cables of differing diameters. E-Chains® and E-Tubes can be subdivided both vertically and horizontally. The shelves can be arranged elevator-shifted with different bottoms

Option 2: Shelves

● Side plates 146, middle plates 148 and shelves 386.X form the basic pattern of a shelf system. Shelves of various widths can be arranged at 7 different heights (in 7 mm increments).

● Slotted separators 1407 are used for very fine subdivisions. However, they cannot be retrofitted into an existing separation system without dismantling the interior separators first.

Side plate for E-Chains®	
unassembled	146
assembled	147

Middle plate for E-Chains®	
unassembled	148
assembled	149

Slotted separator for E-Chains®	
unassembled	1407
assembled	1417

Width X [mm]	Part No. unassembled	Part No. assembled
018	386.18	387.18
023	386.23	387.23
025	386.25	387.25
028	386.28	387.28
033	386.33	387.33
043	386.43	387.43
050	386.50	387.50
054	386.54	387.54
062	386.62	387.62

Width X [mm]	Part No. unassembled	Part No. assembled
075	386.75	387.75
087	386.87	387.87
100	386.100	387.100
108	386.108	387.108
125	386.125	387.125
150	386.150	387.150
175	386.175	387.175
200	386.200	387.200
208	386.208	387.208

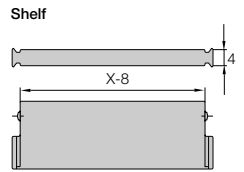
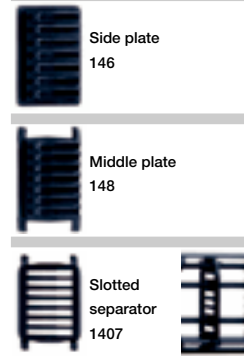

System E4/light
Inner height: 62 mm

Phone +49- (0) 22 03-96 49-800
Fax +49- (0) 22 03-96 49-222





Consult igus® for your extender crossbar applications. We are happy to assist you with your design layout

Extender crossbars - careful guide of hoses applications

- Suitable for hoses with a maximum outer diameter of 115 mm
- Gliding operation with crossbars assembled along the outer radius and a special guide trough
- Gliding operation not guaranteed with crossbars assembled along the inner radius
- The extender crossbar can either be attached to the side links directly or can be used in combination with two stranded snap-open crossbars

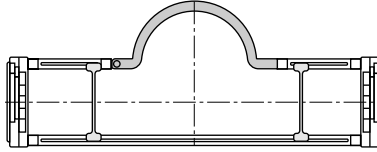

385.15RHD115 round extender crossbar combined with snap-open crossbars

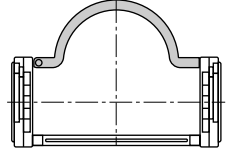

385.18RD115 round strap attached directly on the side link

Part No.	Max Ø [mm] hose	Form	Installation side link	Combination with snap-open crossb.
385.15.RHD115	115	○	-	+
385.18.RD115	115	○	+	-

○ = round + = yes / - = no



Hinged crossbars

- Typically E-Chain® crossbars are completely removable. In cases where the snap-open crossbars have to remain at the open link of the E-Chain®, a hinged design has been developed
- Length: 37,5 mm **Part No. 385.02** / snap-open crossbar (shortened): *Bi*-37,5 mm **Part No. 385.03**
- Please consult igus® for design assistance

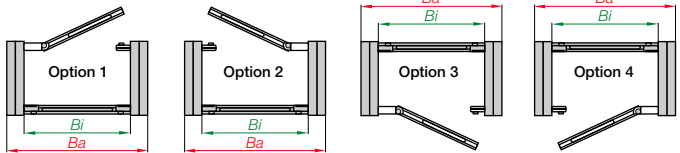
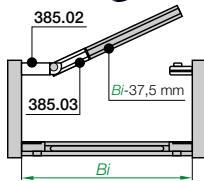

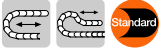

The Standard - Option KMA* - pivoting

- Recommended for unsupported and gliding applications
- Confined installation conditions
- Option - integrated C-profile strain relief device with Chainfix clip or strain relief tiwrap plates
- Corrosion resistant
- Universal mountable with attachment capability on all sides

*KMA = Polymer Metal Mounting Bracket

Moving end
143400...2

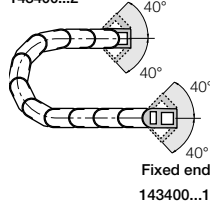

The attachment variants arising automatically by the choice of the KMA mounting bracket

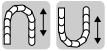
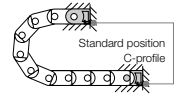

Option KMA - locking

- Recommended for vertical hanging / standing applications
- Additionally:**
- Universal mountable
 - C-profile option
 - Corrosion resistant
 - Locked connections
 - At very high acceleration

Moving end
142400...2

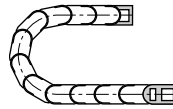

The attachment variants arising automatically by the choice of the KMA mounting bracket

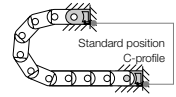

Moving end

143400...2 (pivoting)

142400...2 (locking)

Fixed end

(pivoting) 143400...1

(locking) 142400...1

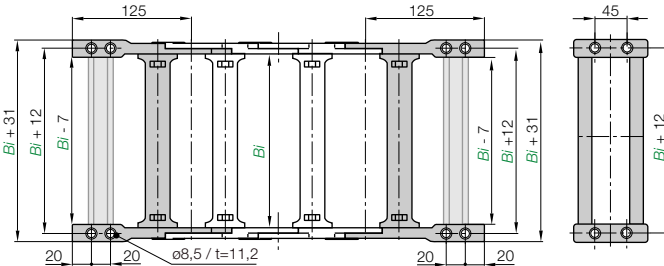

Dimensions and order configurations

Part No. structure (pivoting)

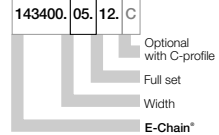

Part No. structure (locking)

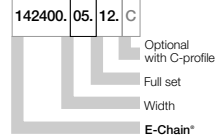

Width index	Part No. full set pivoting	Part No. full set locking	C-profile option [mm]	Width index	Part No. full set pivoting	Part No. full set locking	C-profile option [mm]
.05.	▶ 143400	142400	.05.12. 50	.23.	▶ 143400	142400	.23.12. 225
.06.	▶ 143400	142400	.06.12. 68	.237.	▶ 143400	142400	.237.12. 237
.07.	▶ 143400	142400	.07.12. 75	.25.	▶ 143400	142400	.25.12. 250
.087.	▶ 143400	142400	.087.12. 87	.262.	▶ 143400	142400	.262.12. 262
.10.	▶ 143400	142400	.10.12. 100	.28.	▶ 143400	142400	.28.12. 275
.11.	▶ 143400	142400	.11.12. 108	.29.	▶ 143400	142400	.29.12. 287
.112.	▶ 143400	142400	.112.12. 112	.30.	▶ 143400	142400	.30.12. 300
.12.	▶ 143400	142400	.12.12. 125	.312.	▶ 143400	142400	.312.12. 312
.137.	▶ 143400	142400	.137.12. 137	.325.	▶ 143400	142400	.325.12. 325
.15.	▶ 143400	142400	.15.12. 150	.337.	▶ 143400	142400	.337.12. 337
.162.	▶ 143400	142400	.162.12. 162	.350.	▶ 143400	142400	.350.12. 350
.17.	▶ 143400	142400	.17.12. 175	.362.	▶ 143400	142400	.362.12. 362
.18.	▶ 143400	142400	.18.12. 188	.375.	▶ 143400	142400	.375.12. 375
.187.	▶ 143400	142400	.187.12. 187	.387.	▶ 143400	142400	.387.12. 387
.20.	▶ 143400	142400	.20.12. 200	.400.	▶ 143400	142400	.400.12. 400
.212.	▶ 143400	142400	.212.12. 212				

Full set, for both ends:

142400. [05. 12]

Single-part order:

142400. [05. 1 2]

Mounting bracket moving end

142400. [05. 1]

Mounting bracket fixed end



igus® Chainfix steel clamps and Chainfix stainless-steel clamps - max. pull forces, adjustable with hexagon socket. Available as single, double or triple clamps. **Details ► chapter 10**

Chainfix clamps for the C-profile

Part No. single clamps		Part No. double clamps		Part No. triple clamps		Cable
steel	stainless steel	steel	stainless steel	steel	stainless steel	ø [mm]
CFX12.1	CFX12.1.E	CFX12.2	CFX12.2.E	CFX12.3	-	06 - 12
CFX14.1	CFX14.1.E	CFX14.2	CFX14.2.E	CFX14.3	-	12 - 14
CFX16.1	CFX16.1.E	CFX16.2	CFX16.2.E	CFX16.3	-	14 - 16
CFX18.1	CFX18.1.E	CFX18.2	CFX18.2.E	CFX18.3	-	16 - 18
CFX20.1	CFX20.1.E	CFX20.2	CFX20.2.E	CFX20.3	-	18 - 20
CFX22.1	CFX22.1.E	CFX22.2	CFX22.2.E	CFX22.3	-	20 - 22
CFX26.1	CFX26.1.E	CFX26.2	CFX26.2.E	-	-	22 - 26
CFX30.1	CFX30.1.E	CFX30.2	CFX30.2.E	-	-	26 - 30
CFX34.1	CFX34.1.E	CFX34.2	CFX34.2.E	-	-	30 - 34
CFX38.1	CFX38.1.E	-	-	-	-	34 - 38
CFX42.1	CFX42.1.E	-	-	-	-	38 - 42



Chainfix Clip - Modular snap-on strain relief device for C-profile

Available for all igus® E-ChainSystems® with C-profiles and also suitable for assembly in the KMA mounting brackets and clip-on strain relief for crossbars. High pull forces, plug-in modular snap-on strain relief device. **Details ► chapter 10**

Cable ø [mm]	Part No. clamp	Part No. bottom part
04 - 08	CFC-08-M	CFC-08-C
08 - 12	CFC-12-M	CFC-12-C
12 - 16	CFC-16-M	CFC-16-C
16 - 20	CFC-20-M	CFC-20-C
20 - 24	CFC-24-M	CFC-24-C



Chainfix Nugget for the C-Profile

Strain relief for the fixation of cables up to a diameter of Ø 30 mm. Easy to assemble, without any screws and tools. Easy strain relief due to fixation with pre-harnessed cable strap, very small space requirement. **Details ► chapter 10**

Part No.	ø max. conduit [mm]	Width [mm]
CFN.20	20	10,8
CFN.30.52	30	16,8
CFN.20.N35	20	20,0

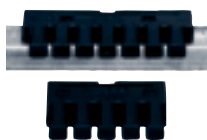

Chainfix tiwrap plates with clip-on connection for the C-profile

Can be plugged into the KMA C-profile. Easy to assemble without any screws. Easily solvable with screwdriver nevertheless safe stop. For all E-Chains® with KMA and integrated C-profile. **Details ► chapter 10**

Part No.	Width of strain relief [mm]	Number of teeth
3050.ZC	50	5
3075.ZC	75	7



Tiwrap plate as individual part

As individual component screwed on KMA. Can be plugged in the mounting brackets. **Details ► chapter 10**

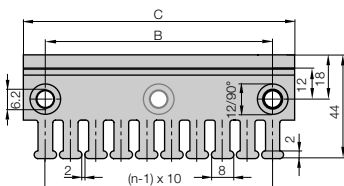
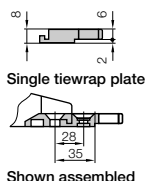

Tiwrap plate	No. of teeth n	Dim. C [mm]	Dim. B [mm]	Center bore
3050.ZB	5	50	30	-
3075.ZB	7	75	55	-
3100.ZB	10	100	80	-
3115.ZB	11	115	95	-
3125.ZB	12	125	105	-
3150.ZB	15	150	130	-
3175.ZB	17	175	155	-
3200.ZB	20	200	180	+
3225.ZB	22	225	205	+
3250.ZB	25	250	230	+

(- = no / + = yes)

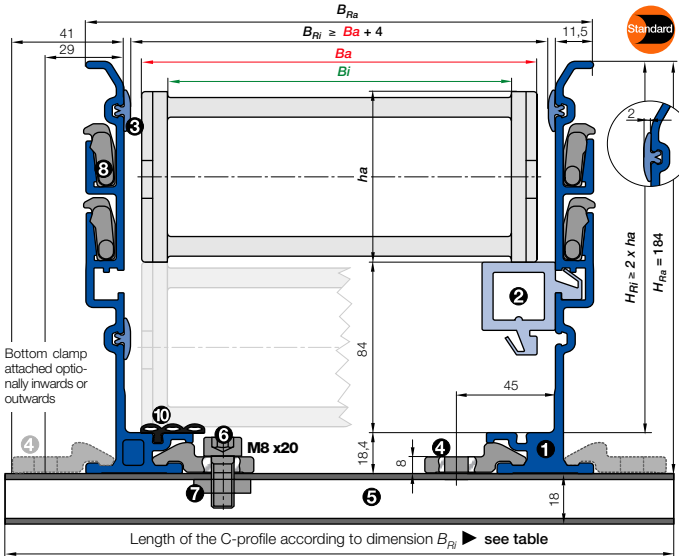

- B_a = Outer width E-Chains* / E-Tube
- B_i = Inner width E-Chains* / E-Tube
- h_a = Outer height E-Chains* / E-Tube
- H_{Ri} = Inner trough height
- H_{Ra} = Outer trough height
- B_{Ri} = Inner trough width ▶ depends on dim. B_a
- B_{Ra} = Outer trough width
- n_{Mon} = Number of installation sets (left/right)
- n_{Ri} = Number of troughs sets (left/right)
- $H_{Ri} \geq 2 \cdot h_a$
- $B_{Ri} \geq B_a + 4$
- = Guide trough set ● = Glide bar
- = Installation set "Basic" ● = C-profile

Installation set "Basic" with C-profile

Bottom Clamp attached optionally inwards or outwards ▶

14240.05.200.0 ▶ Order example

B_{Ri} [mm]	Part No.	
	attached inwards	attached outwards
.05	80	960.50.200
.06	98	960.50.225
.07	105	960.50.225
.087	118	960.50.175 960.50.250
.10	130	960.50.200 960.50.250
.11	138	960.50.200 960.50.275
.112	143	960.50.200 960.50.275
.12	155	960.50.225 960.50.275
.137	168	960.50.225 960.50.300
.15	180	960.50.250 960.50.300
.162	193	960.50.250 960.50.325
.17	198	960.50.250 960.50.325
.18	205	960.50.275 960.50.325
.187	218	960.50.275 960.50.350
.20	230	960.50.300 960.50.350
.212	243	960.50.300 960.50.375
.23	255	960.50.325 960.50.375
.237	268	960.50.325 960.50.400
.25	280	960.50.350 960.50.400
.262	293	960.50.350 960.50.425
.28	305	960.50.375 960.50.425
.29	318	960.50.375 960.50.450
.30	330	960.50.400 960.50.450
.312	343	960.50.400 960.50.475
.325	355	960.50.425 960.50.475
.337	368	960.50.425 960.50.500
.350	380	960.50.450 960.50.500
.362	393	960.50.450 960.50.525
.375	405	960.50.475 960.50.525
.387	418	960.50.475 960.50.550
.400	430	960.50.500 960.50.550



- **Components, trough "Basic":** ① Trough side parts, aluminum, 2 m ② Glide bar, plastic, 2 m ③ Glide strips, plastic, 2 m (without glide strips on request) ⑩ Optional: Silencer profile, rubber
- **Components, installation set "Basic":** ④ Bottom clamp, aluminum ⑤ C-profile, steel galvanized ⑥ Screw M8 x20 ⑦ Sliding nut M8 ⑧ Interface connector, plastic

Order example: Length of travel 30 m - Center mounted for Series 14240.10.200.0 with $B_{Ri} = 130$

- Guide trough set (set of 2 trough side parts, incl. glide strips) **without** glide bar
Order text: 16 m guide trough without glide bar (8 x 2 m sections) Part No. 974.30.SL
- Guide trough set (set of 2 trough side parts, incl. glide strips) **with** glide bar
Order text: 16 m guide trough with glide bar (8 x 2 m sections) Part No. 974.31.SL
- Installation set "Basic" complete (guide trough-sets + 1)
Order text: 17 installation sets "Basic" Part No. 960.50.200
- Module for the fixed end
Order text: 1 set Part No. 974.81
- Option: For an additional noise dampening with silencer profile, please add Index A - Example: Part No. 974.30.SLA

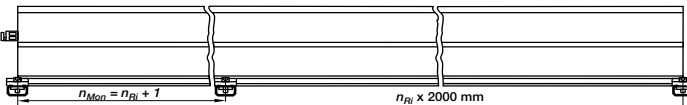

Principle sketch: Number of installation sets to be installed = Number of trough sections + 1

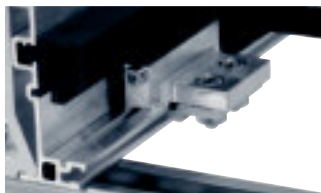

A quick fix for mounting the stationary end of an E-Chain®
With this module for the fixed end, fast and easy mounting onto the Aluminum "SuperTrough" is now possible without any drilling. Fast mounting of the E-Chain® by clamping onto the aluminum trough

- Quick relocation of the stationary end
- No drilling necessary ▶ page 9.16

Insert for the installation set "Heavy-Duty": 974.50.XXX instead of (960.50.XXX) on the right column "attached outwards"

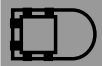

Price index



Series 15050 Series 15150 Series R19850



ESD classification:
Electrically conductive ESD/ATEX
version upon request



**High torsional
rigidity**



**Side-mounted -
unsupported**



Opening E-Chains: Remove crossbars and clips - Insert screwdriver into the slot, push down, release by lever action



Remove lids/bottoms (E-Tubes) - Insert screwdriver into the slot, release by lever action



When to use the Series 15050/15150/R19850:

- For achieving simple, economical solutions
- For minimizing a chain's external width at any given internal width
- For use if Series 5050 proves too large



When not to use it:

- If long side-mounted, unsupported length is required
- Series E4.80, page 7.76

- 1 Stronger version with undercut design
- 2 High torsional rigidity
- 3 Crossbars are removable along both radii
- 4 Hinged snap-open removable lids along outer radius
- 5 Closed and open styles can be combined
- 6 Lateral glide surfaces for side-mounted operation
- 7 Numerous interior separation possibilities
- 8 Wide, rounded plastic crossbars - cable friendly
- 9 KMA mounting brackets with attachment points on all sides
- 10 Integrated strain relief possible

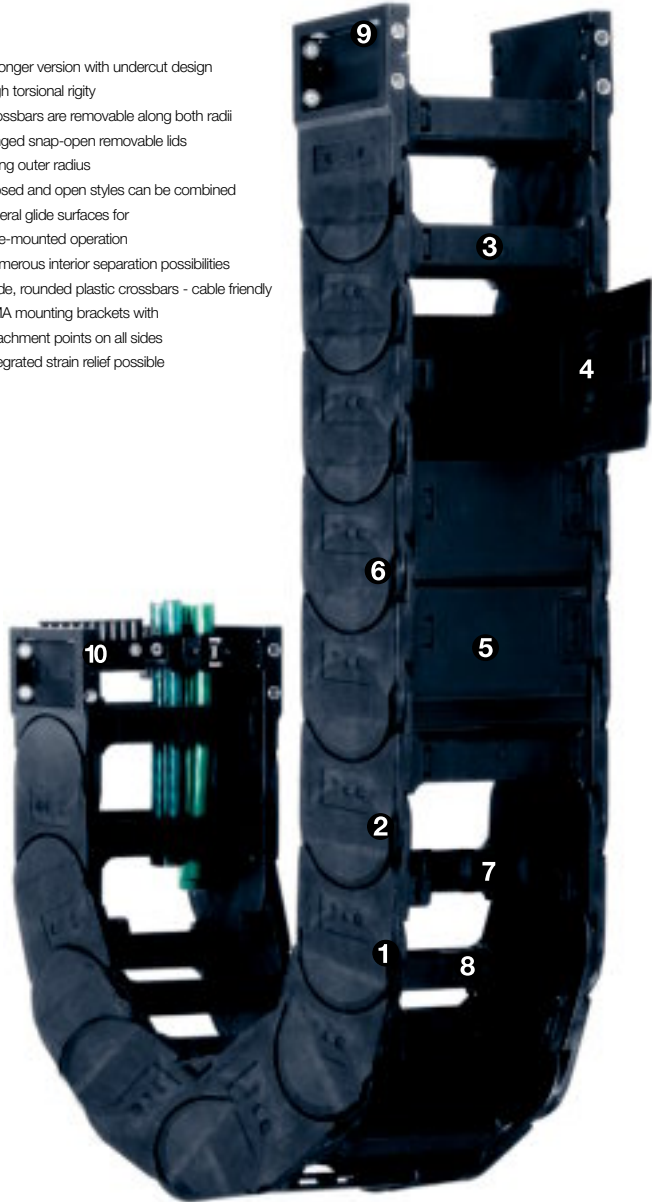

Order example complete E-Chain®

Please indicate chain-lengths or number of links **Example: 5 m or 55 links**

5 m 15050.30.300.0

 E-Chain®

with 2 separators 511 assembled every 2nd link

 Interior separation

1 set 150500.30.12C

 Mounting bracket



Unsupported length

FL_G = with straight upper run

FL_B = with permitted sag

Further information ► **Design, page 1.12**

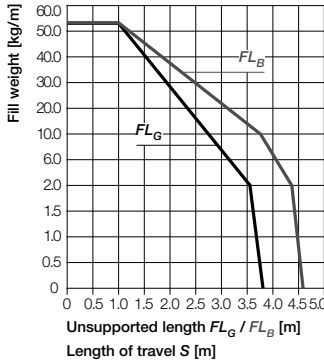
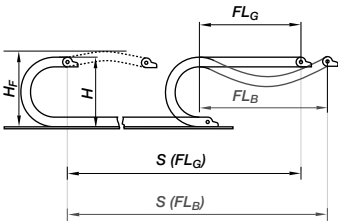

- S = Length of travel
 - R = Bending radius
 - H = Nominal clearance height
 - H_F = Required clearance height
 - H_{R1} = Trough inner height
 - D = Overlength E-Chain® radius in final position
 - $K = \pi \cdot R + \text{"safety"}$
 - D_2 = Over length - long travels, gliding
 - K_2 = *Further add-on
 - H_2 = *Mounting height
- *if the mounting bracket location is set lower

Other installation methods

- Vertical, hanging ≤ 100 m
- Vertical, standing ≤ 6 m
- Side mounted, unsp. ≤ 2 m
- Rotary requires further calculation
- Unsupported length of upper run = upon request

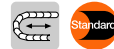

Short travels - unsupported

Unsupported E-Chains® feature positive camber over short travels. This must be accounted for when specifying the clearance height H_F . Please consult igus® if space is particularly restricted.

The required clearance height:
 $H_F = H + 60$ mm
(with 3,0 kg/m fill weight)

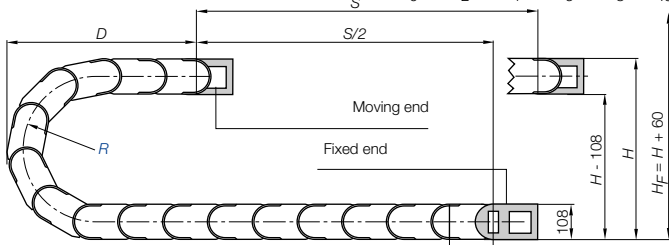

Pitch = 91 mm/link Links/m = 11 (1001 mm) Chain length = $S/2 + K$

R	150	200	250	300	350	400	500
H_{R1}^{90}	410	510	610	710	810	910	1110
D	300	350	400	450	500	550	650
K	750	900	1050	1225	1375	1450	1675
H_2	242	242	242	242	242	242	242
D_2^{+25}	550	800	950	1200	1550	1700	2175
K_2	910	1274	1638	2002	2457	2730	3458

Long travel lengths from 10 m to max. 250 m Chain length = $S/2 + K_2$

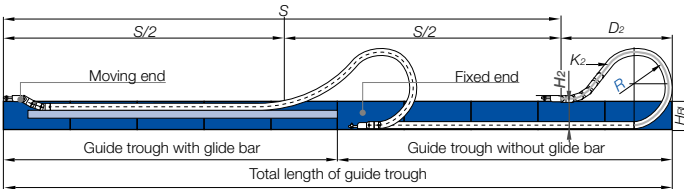

In case of travels between 4 and 10 m we recommend a longer unsupported length.



Gliding, long travel applications (max. 250 m)

In this case the E-Chain® upper run will be introduced in a guide trough on the lower run. We recommend to realize the engineering of such a plant by our technicians.

Technical Data

Speed / acceleration FL_G	max. 20 [m/s] / max. 200 [m/s²]
Speed / acceleration FL_B	max. 3 [m/s] / max. 6 [m/s²]
Gliding speed / acceleration (maximum)	max. 10 [m/s] / max. 50 [m/s²]
Material - permitted temperature °C	igumid G / -40° up to +120° C
Flammability class, igumid G	VDE 0304 IIC UL94 HB



Details of material properties
► page 1.38

80

System E4/light
Inner height: 80 mm

Phone +49- (0) 22 03-96 49-800
Fax +49- (0) 22 03-96 49-222



► page 7.123

For support of the lower run - **Support Tray tool kit** available ► page 9.70

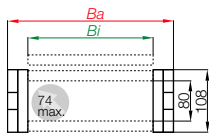

Part No. structure

15050.30.300.0



Series 15050 - E-Chain® with crossbars every link



- Crossbars every link
- For rigid hydraulic hoses
- For applications particularly demanding
- Can be opened from two sides

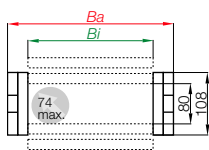

Part No. structure

15150.30.300.0



Series 15150 - E-Chain® with crossbars every 2nd link

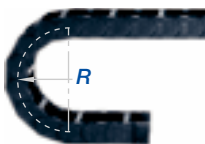

- Crossbars every 2nd link = Standard
- For nearly every situation
- Can be opened from two sides
- Easy assembly
- Stable
- Attractive price

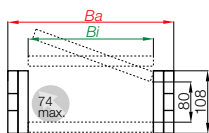

Part No. structure

19850.30.300.0



Series R19850 - Fully enclosed E-Tube

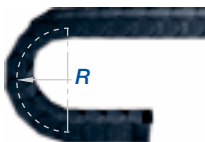

- Fully enclosed
- Excellent cable protection against dirt
- Protection against hot chips (up to 900°C)
- Lids along the entire inner radius are completely removable. Lids along the entire outer radius are single sided snap-open with a hinge on the other side to keep them attached to the chain or completely removable.



Part No.	[mm]	Bi	Ba	15050	15150	R19850
		[mm]	[mm]	[kg/m]	[kg/m]	[kg/m]
15050/15150.05	.0	50	80	≈ 3,85	≈ 3,84	-
15050/15150.06	.0	65	95	≈ 3,95	≈ 3,88	-
15050/15150/19850.07	.0	75	105	≈ 4,00	≈ 3,92	≈ 4,46
15050/15150.08	.0	87	117	≈ 4,05	≈ 3,96	-
15050/15150/19850.10	.0	100	130	≈ 4,18	≈ 4,00	≈ 4,74
15050/15150.11	.0	112	143	≈ 4,31	≈ 4,07	-
15050/15150/19850.12	.0	125	155	≈ 4,38	≈ 4,10	≈ 5,10
15050/15150.13	.0	137	168	≈ 4,51	≈ 4,17	-
15050/15150/19850.15	.0	150	180	≈ 4,58	≈ 4,20	≈ 5,53
15050/15150.16	.0	162	193	≈ 4,69	≈ 4,26	-
15050/15150.17	.0	175	205	≈ 4,80	≈ 4,31	-
15050/15150.18	.0	187	218	≈ 4,91	≈ 4,37	-
15050/15150/19850.20	.0	200	230	≈ 4,93	≈ 4,38	≈ 6,11
15050/15150.21	.0	212	243	≈ 5,04	≈ 4,43	-
15050/15150.22	.0	225	255	≈ 5,10	≈ 4,47	-
15050/15150.23	.0	237	268	≈ 5,24	≈ 4,53	-
15050/15150/19850.25	.0	250	280	≈ 5,32	≈ 4,58	≈ 6,83
15050/15150.26	.0	262	293	≈ 5,41	≈ 4,62	-
15050/15150/19850.27	.0	275	305	≈ 5,52	≈ 4,68	≈ 7,26
15050/15150.28	.0	287	318	≈ 5,54	≈ 4,69	-
15050/15150/19850.30	.0	300	330	≈ 5,76	≈ 4,80	≈ 7,49
15050/15150.31	.0	312	343	≈ 5,80	≈ 4,82	-
15050/15150.32	.0	325	355	≈ 5,85	≈ 4,84	-
15050/15150.33	.0	337	368	≈ 6,03	≈ 4,93	-
15050/15150/19850.35	.0	350	380	≈ 6,18	≈ 5,01	≈ 8,24
15050/15150.36	.0	362	393	≈ 6,19	≈ 5,02	-
15050/15150.37	.0	375	405	≈ 6,20	≈ 5,02	-
15050/15150.38	.0	387	418	≈ 6,29	≈ 5,06	-
15050/15150/19850.40	.0	400	430	≈ 6,49	≈ 5,16	≈ 9,20
15050/15150.41	.0	412	443	≈ 6,64	≈ 5,24	-
15050/15150.42	.0	425	455	≈ 6,80	≈ 5,31	-
15050/15150.43	.0	437	468	≈ 6,86	≈ 5,35	-
15050/15150.45	.0	450	480	≈ 6,93	≈ 5,38	-
15050/15150/19850.46	.0	462	493	≈ 6,95	≈ 5,39	≈ 9,66
15050/15150.47	.0	475	505	≈ 7,08	≈ 5,46	-
15050/15150.48	.0	487	518	≈ 7,16	≈ 5,49	-
15050/15150.50	.0	500	530	≈ 7,22	≈ 5,52	-
15050/15150.51	.0	512	543	≈ 7,24	≈ 5,53	-
15050/15150.52	.0	525	555	≈ 7,28	≈ 5,56	-
15050/15150.53	.0	537	568	≈ 7,44	≈ 5,63	-
15050/15150.55	.0	550	580	≈ 7,92	≈ 5,87	-
15050/15150.60	.0	600	630	≈ 8,12	≈ 5,97	-

Hot Chips up to 850°C

E-Tubes that repel hot chips, up to 850°C. Some applications, depending on amount and size of the chips, can burn or melt the surface. That is no longer the case with the igus® "igumid HT" material. Order example: Full E-Tube made of HT: **19850.40.200.0.HT**
Lids made of HT: **19850.40.HTE.200.0**

*for long travels. Upon request.
Further Information: www.igus.de/en/HT
Delivery time up to 4 weeks!

System E4/light
Inner height: 80 mm

Phone +49- (0) 22 03-96 49-800
Fax +49- (0) 22 03-96 49-222

Available bending radii

R [mm] **150*** **200** **250** **300** **350** **400** **500** *not available for R19850

Supplement Part No. with required radius. Example: 15050.30.**300**.0

0 = standard color, other colors ▶ page 1.39 · Pitch = 91 mm/link · Links/m = 11

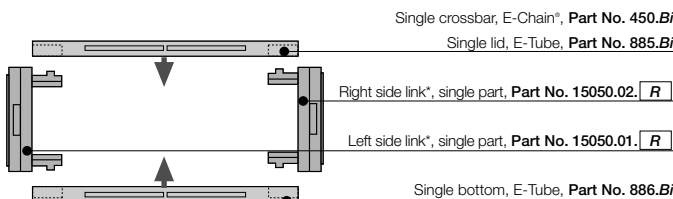

Extender crossbar for large diameter hoses ▶ page 7.150

Part No. E-Chain® - links, single parts

*View from the fixed point of the E-Chain®/E-Tube

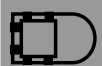

▶ page 7.123



Vertical separators are used if a vertical subdivision is required. In the standard configuration, a separator is mounted at every second link. **Note:** Observe a lateral spacing of at least 16 mm!

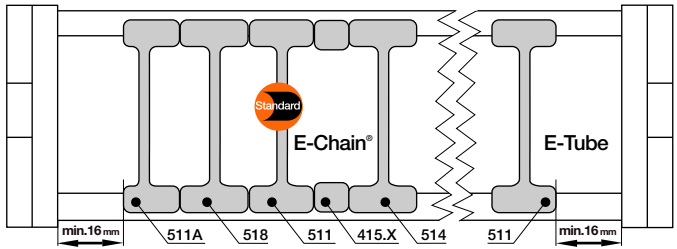

Vertical separator
501



Spacer
405.XX



Locking separator
504



Locking separator
508



Asymmetric
separator 501A

**Vertical separator
for E-Chains®/E-Tubes**

unassembled	501
assembled	511



Spacer*
for E-Chains®

unassembled	405.XX
assembled	415.XX



**Locking separator
for E-Chains®**

unassembled	504
assembled	514



**Locking separator
for E-Chains®**

unassembled	508
assembled	518



**Asymmetric separator
for E-Chains®**

unassembled	501A
assembled	511A



*For side-mounted applications

Option 1: Vertical separators and spacers

● **Standard separator 501 for E-Chains®** offers safe stability due to its broad foot design, also when used with thick cables or hoses.

● Separators (e.g. "side mounted") for E-Chains® can be fixed in their position with **spacers 405.XX**. The available inner height will be reduced by 2 mm, per spacer and side. To avoid this, the parts can be assembled on outside of the crossbar (not for long travels) **XX = width of the spacer** (available 10, 15, 20, 30 and 40 mm)

Additionally:

● **Locking separator for E-Chains® 504-** with increased retention force for applications exposed to very high humidity or extreme loads. If locking separators are used, the E-Chain® is more difficult to open

● The **locking separator for E-Chains® 508** is designed for applications exposed to extremely high humidity, for example, at composting plants. The lateral cam serves for uniform alignment of the vertical separators; if these separators are misaligned, they will inevitably get damaged on an attempt to open the E-Chain®.

● **Asymmetric separator 501A for E-Chains®** (not for E-Tubes) with an 18-mm base, for combinations between spacers of different widths and vertical separators in side-mounted applications, for instance.

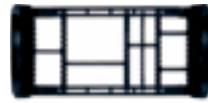
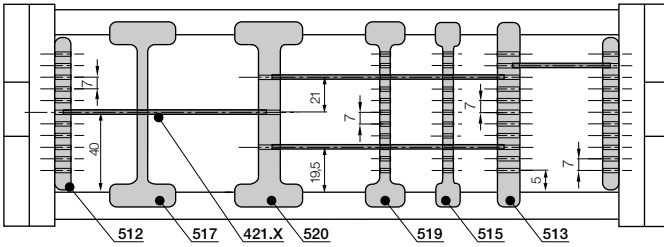

For use with many cables of differing diameters. E-Chains* and E-Tubes can be subdivided both vertically and horizontally. The shelves can be arranged elevator-shifted with different bottoms

Option 2: Shelves

● **Side plates 502, middle plates 503 and shelves 420.X** form the basic pattern of a shelf system. Shelves of various widths can be arranged at 11 different heights (in 7 mm increments).

● **Locking vertical separator 510** combined with shelves. Triple slots (only for E-Chains*).

● **Locking separator 507 slotted** - with increased retention force for applications exposed to very high humidity or extreme loads. The extra retention force is achieved by asymmetric claws for the crossbar. Ensure proper alignment.

● **Slotted separators 505** are used for very fine subdivisions. However, they cannot be retrofitted into an existing separation system without dismantling the interior separators first.

● The unilateral **open slotted separator 509** can be retrofitted into an existing interior separation system without a need for dismantling the interior separators. During an installation of open slotted separators, the top and bottom notches cannot be occupied by shelves.

Side plate for E-Chains*/E-Tubes	
unassembled	502
assembled	512

Middle plate for E-Chains*/E-Tubes	
unassembled	503
assembled	513

Locking vertical separator for E-Chains*	
unassembled	510
assembled	520

Locking separator for E-Chains*	
unassembled	507
assembled	517

Slotted separator for E-Chains*/E-Tubes	
unassembled	505
assembled	515

Open slotted separator for E-Chains*/E-Tubes	
unassembled	509
assembled	519

Width X [mm]	Part No. unassembled	Part No. assembled
018	420.18	421.18
023	420.23	421.23
025	420.25	421.25
028	420.28	421.28
033	420.33	421.33
043	420.43	421.43
050	420.50	421.50
062	420.62	421.62

Width X [mm]	Part No. unassembled	Part No. assembled
075	420.75	421.75
088	420.88	421.88
100	420.100	421.100
125	420.125	421.125
150	420.150	421.150
175	420.175	421.175
187	420.187	421.187
200	420.200	421.200



Side plate 502

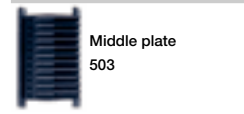

Middle plate 503

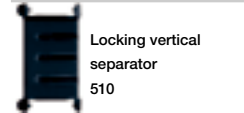

Locking vertical separator 510

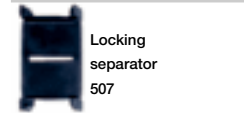

Locking separator 507

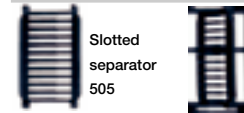

Slotted separator 505



Open slotted separator 509



Shelf 420.X

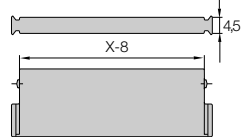

Additional elements for interior separation

Rollclip	
unassembled	489.27
assembled	490.27

Rollclip - minimizes abrasion of particularly sensitive hoses. The Rollclip is simply clamped onto the opening crossbar. The movable rollers compensate for relative movement between the chain and hose.

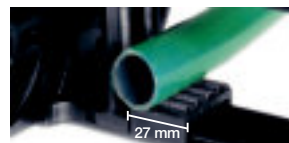

27 mm

System E4/light
Inner height: 80 mm

Phone +49- (0) 22 03-96 49-800
Fax +49- (0) 22 03-96 49-222

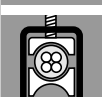



Extension links - for extremely wide E-Chains® up to 3,0 m

- For applications in which particularly high fill weights necessitate extremely wide E-Chains® (up to 3000 mm)
- The extension link design allows virtually limitless side-by-side attachment of chains
- The unsupported length of a chain can be increased when additional loads are required
- Extension links can be used with E-Chains®, E-Tubes or as a combination of both
- They are suitable for unsupported and gliding applications in a guide trough
- E-Chains® with extension links are attached with KMA or steel mounting brackets



Part No. structure

15050.10 /20 /10. .0

15050.Bi1/Bi2/Bi3. .0

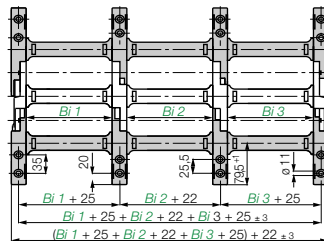
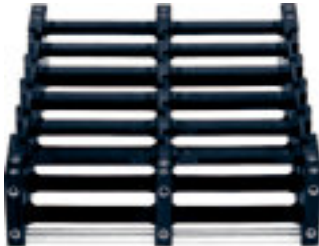

Extender crossbars - careful guide of hoses applications

- Suitable for hoses with a maximum outer diameter of 270 mm
- Gliding operation with crossbars assembled along the outer radius and a special guide trough
- Gliding operation not guaranteed with crossbars assembled along the inner radius
- The extender crossbar can either be attached to the side links directly or can be used in combination with two stranded snap-open crossbars

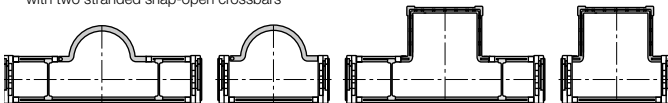

Round extender crossbar with snap-open crossbars Attached directly to the side link Square extender crossbar with snap-open crossbars Attached directly to the side link

Consult igus® for your extender crossbar applications. We are happy to assist you with your design layout

Part No.	Max Ø [mm] hose	Form	Installation side link	Combination with snap-open crossb.
450.15.RHD115	115	○	-	+
450.17.RD115	115	○	+	-
450.25.D150	150	□	+	-
450.30.D200	200	□	+	-
450.35.D250	220	□	+	-
450.40.D300	270	□	+	-
450.20.HD150	150	□	-	+
450.25.HD200	200	□	-	+
450.30.HD250	220	□	-	+

○ = round □ = square + = yes / - = no



E4 clip-on cable binder

- For side-mounted applications
- Serves as a clip-on, lateral guide for hoses and cables on E-Chains®
- The loops can be adjusted as required
- Compatible with many E4 E-Chains®
- Stylish and economical
- One clip and one locking band are needed for each chain link
- Call us if you have any questions on project planning

Part No.	Form
450.B12	Locking clip, comprising a locking element
450.B12.200	Locking band, comprising a locking element and band; 12 x 1,5 x 200 mm

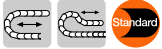

The Standard - Option KMA* - pivoting

- Recommended for unsupported and gliding applications
- Confined installation conditions
- Option - integrated C-profile strain relief device with Chainfix clip or strain relief tiwrap plates
- Corrosion resistant
- Universal mountable with attachment capability on all sides

*KMA = Polymer Metal Mounting Bracket

Moving end

150500/198500...2

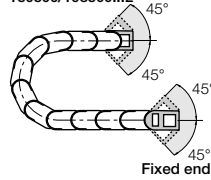

Fixed end

150500/198500...1



The attachment variants arising automatically by the choice of the KMA mounting bracket

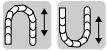
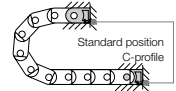

Option KMA - locking

- Recommended for vertical hanging / standing applications

Additionally:

- Universal mountable
- C-profile option
- Corrosion resistant
- Locked connections
- At very high acceleration

Moving end

151500/199500...2

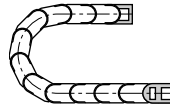

Fixed end

151500/199500...1



The attachment variants arising automatically by the choice of the KMA mounting bracket

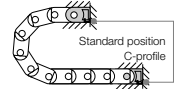

Moving end

150500/198500...2 (pivoting)

151500/199500...2 (locking)

Fixed end

(pivoting) 150500/198500...1

(locking) 151500/199500...1

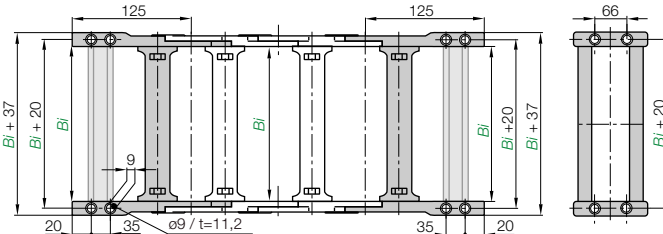

Dimensions and order configurations

Part No. structure (pivoting)

150500.07.12.C

198500.

Optional with C-profile

Full set

Width

150500 = E-Chain*

198500 = E-Tube

Part No. structure (locking)

151500.07.12.C

199500.

Optional with C-profile

Full set

Width

151500 = E-Chain*

199500 = E-Tube

Width			Part No. full set			C-profile			Width			Part No. full set			C-profile				
index	pivoting	locking	option [mm]	Bi	index	pivoting	locking	option [mm]	Bi	index	pivoting	locking	option [mm]	Bi	index	pivoting	locking	option [mm]	Bi
.05.	▶ 150500	151500	.05.12. C	50	.32.	▶ 150500	151500	32.12. C	325										
.06.	▶ 150500	151500	.06.12. C	65	.33.	▶ 150500	151500	.33.12. C	337										
.07.	▶ 150500/198500	151500/199500	.07.12. C	75	.35.	▶ 150500/198500	151500/199500	.35.12. C	350										
.10.	▶ 150500/198500	151500/199500	.10.12. C	100	.36.	▶ 150500	151500	.36.12. C	362										
.11.	▶ 150500	151500	.11.12. C	112	.37.	▶ 150500	151500	.37.12. C	375										
.12.	▶ 150500/198500	151500/199500	.12.12. C	125	.38.	▶ 150500	151500	.38.12. C	387										
.13.	▶ 150500	151500	.13.12. C	137	.40.	▶ 150500/198500	151500/199500	.40.12. C	400										
.15.	▶ 150500/198500	151500/199500	.15.12. C	150	.41.	▶ 150500	151500	.41.12. C	412										
.16.	▶ 150500	151500	.16.12. C	162	.42.	▶ 150500	151500	.42.12. C	425										
.17.	▶ 150500	151500	.17.12. C	175	.43.	▶ 150500	151500	.43.12. C	437										
.18.	▶ 150500	151500	.18.12. C	187	.45.	▶ 150500	151500	.45.12. C	450										
.20.	▶ 150500/198500	151500/199500	.20.12. C	200	.46.	▶ 150500/198500	151500/199500	.46.12. C	462										
.21.	▶ 150500	151500	.21.12. C	212	.47.	▶ 150500	151500	.47.12. C	475										
.22.	▶ 150500	151500	.22.12. C	225	.48.	▶ 150500	151500	.48.12. C	487										
.23.	▶ 150500	151500	.23.12. C	237	.50.	▶ 150500	151500	.50.12. C	500										
.25.	▶ 150500/198500	151500/199500	.25.12. C	250	.51.	▶ 150500	151500	.51.12. C	512										
.26.	▶ 150500	151500	.26.12. C	262	.52.	▶ 150500	151500	.52.12. C	525										
.27.	▶ 150500/198500	151500/199500	.27.12. C	275	.53.	▶ 150500	151500	.53.12. C	537										
.28.	▶ 150500	151500	.28.12. C	287	.55.	▶ 150500	151500	.55.12. C	550										
.30.	▶ 150500/198500	151500/199500	.30.12. C	300	.60.	▶ 150500	151500	.60.12. C	600										
.31.	▶ 150500	151500	.31.12. C	312															

Full set, for both ends:

151500. [05. 12]

Single-part order:

151500. [05. 1 2]

Mounting bracket moving end

151500. [05. 1]

Mounting bracket fixed end

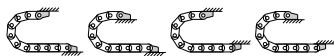

Possible installation conditions -
Further installation angles ► installation sketch

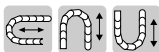

Option steel - pivoting

- For pivoting connections
- One part (two-piece) for all chain widths
- Electrically conductive

Moving end
15050.1

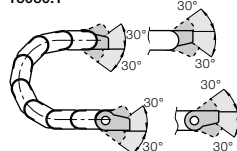

Fixed end
15050.2

Moving end
15050.1

Fixed end
15050.2

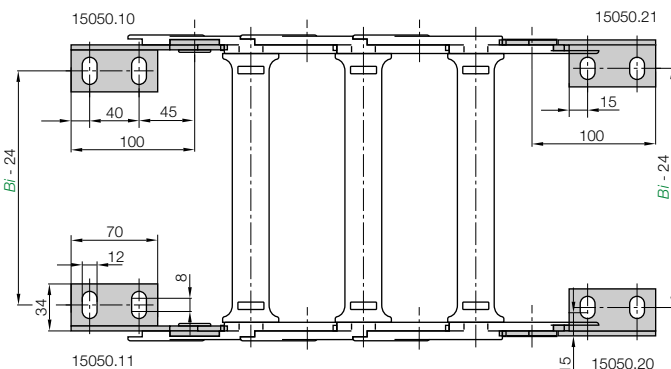

Phone +49- (0) 22 03-96 49-800
Fax +49- (0) 22 03-96 49-222

igus® GmbH
51147 Cologne

15050.12 Full set, 4 parts
2 with pin / 2 with bore

Single-part order:

15050.1 Mounting bracket

moving end, 1 part left / right

15050.2 Mounting bracket

fixed end, 1 part left / right

For E-Chain®	Part No.	Bi	For E-Chain®	Part No.	Bi
	full set	[mm]		full set	[mm]
15050-15150.05	► 15050.12	50	15050-15150.32	► 15050.12	325
15050-15150.06	► 15050.12	65	15050-15150.33	► 15050.12	337
15050-15150-19850.07	► 15050.12	75	15050-15150-19850.35	► 15050.12	350
15050-15150-19850.10	► 15050.12	100	15050-15150.36	► 15050.12	362
15050-15150.11	► 15050.12	112	15050-15150.37	► 15050.12	375
15050-15150-19850.12	► 15050.12	125	15050-15150.38	► 15050.12	387
15050-15150.13	► 15050.12	137	15050-15150-19850.40	► 15050.12	400
15050-15150-19850.15	► 15050.12	150	15050-15150.41	► 15050.12	412
15050-15150.16	► 15050.12	162	15050-15150.42	► 15050.12	425
15050-15150.17	► 15050.12	175	15050-15150.43	► 15050.12	437
15050-15150.18	► 15050.12	187	15050-15150.45	► 15050.12	450
15050-15150-19850.20	► 15050.12	200	15050-15150-19850.46	► 15050.12	462
15050-15150.21	► 15050.12	212	15050-15150.47	► 15050.12	475
15050-15150.22	► 15050.12	225	15050-15150.48	► 15050.12	487
15050-15150.23	► 15050.12	237	15050-15150.50	► 15050.12	500
15050-15150-19850.25	► 15050.12	250	15050-15150.51	► 15050.12	512
15050-15150.26	► 15050.12	262	15050-15150.52	► 15050.12	525
15050-15150-19850.27	► 15050.12	275	15050-15150.53	► 15050.12	537
15050-15150.28	► 15050.12	287	15050-15150.55	► 15050.12	550
15050-15150-19850.30	► 15050.12	300	15050-15150.60	► 15050.12	600
15050-15150.31	► 15050.12	312			

Other strain relief elements
► chapter 10

Internet: www.igus.eu
E-mail: info@igus.de

Chainfix clamps for the C-profile

Part No. single clamps		Part No. double clamps		Part No. triple clamps		Cable
steel	stainless steel	steel	stainless steel	steel	stainless steel	ø [mm]
CFX12.1	CFX12.1.E	CFX12.2	CFX12.2.E	CFX12.3	-	06 - 12
CFX14.1	CFX14.1.E	CFX14.2	CFX14.2.E	CFX14.3	-	12 - 14
CFX16.1	CFX16.1.E	CFX16.2	CFX16.2.E	CFX16.3	-	14 - 16
CFX18.1	CFX18.1.E	CFX18.2	CFX18.2.E	CFX18.3	-	16 - 18
CFX20.1	CFX20.1.E	CFX20.2	CFX20.2.E	CFX20.3	-	18 - 20
CFX22.1	CFX22.1.E	CFX22.2	CFX22.2.E	CFX22.3	-	20 - 22
CFX26.1	CFX26.1.E	CFX26.2	CFX26.2.E	-	-	22 - 26
CFX30.1	CFX30.1.E	CFX30.2	CFX30.2.E	-	-	26 - 30
CFX34.1	CFX34.1.E	CFX34.2	CFX34.2.E	-	-	30 - 34
CFX38.1	CFX38.1.E	-	-	-	-	34 - 38
CFX42.1	CFX42.1.E	-	-	-	-	38 - 42

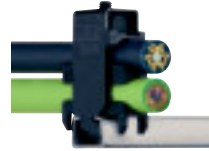

igus® Chainfix steel clamps and Chainfix stainless-steel clamps - max. pull forces, adjustable with hexagon socket. Available as single, double or triple clamps. **Details ▶ chapter 10**

System E4/light
Inner height: 80 mm

Cable ø [mm]	Part No. clamp	Part No. bottom part
04 - 08	CFC-08-M	CFC-08-C
08 - 12	CFC-12-M	CFC-12-C
12 - 16	CFC-16-M	CFC-16-C
16 - 20	CFC-20-M	CFC-20-C
20 - 24	CFC-24-M	CFC-24-C

Chainfix Clip - Modular snap-on strain relief device for C-profile

Available for all igus® E-ChainSystems® with C-profiles and also suitable for assembly in the KMA mounting brackets and clip-on strain relief for crossbars. High pull forces, plug-in modular snap-on strain relief device. **Details ▶ chapter 10**



Part No.	ø max. conduit [mm]	Width [mm]
CFN.20	20	10,8
CFN.30.52	30	16,8
CFN.20.N35	20	20,0

Chainfix Nugget for the C-Profile

Strain relief for the fixation of cables up to a diameter of Ø 30 mm. Easy to assemble, without any screws and tools. Easy strain relief due to fixation with pre-harnessed cable strap, very small space requirement. **Details ▶ chapter 10**



Part No.	Width of strain relief [mm]	Number of teeth
3050.ZC	50	5
3075.ZC	75	7

Chainfix tiwrap plates with clip-on connection for the C-profile

Can be plugged into the KMA C-profile. Easy to assemble without any screws. Easily solvable with screwdriver nevertheless safe stop. For all E-Chains® with KMA and integrated C-profile. **Details ▶ chapter 10**

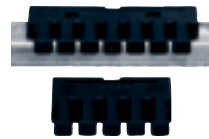

Tiewrap plate	No. of teeth n	Dim. C [mm]	Dim. B [mm]	Center bore
3050.ZB	5	50	30	-
3075.ZB	7	75	55	-
3100.ZB	10	100	80	-
3115.ZB	11	115	95	-
3125.ZB	12	125	105	-
3150.ZB	15	150	130	-
3175.ZB	17	175	155	-
3200.ZB	20	200	180	+
3225.ZB	22	225	205	+
3250.ZB	25	250	230	+

(- = no / + = yes)

Tiewrap plate as individual part

As individual component screwed on KMA. Can be plugged in the mounting brackets. **Details ▶ chapter 10**

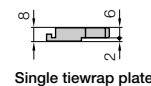
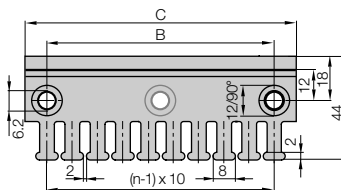

Single tiewrap plate

Shown assembled



▶ page 7.123

- B_a = Outer width E-Chains® / E-Tube
- B_i = Inner width E-Chains® / E-Tube
- h_a = Outer height E-Chains® / E-Tube
- H_{Ri} = Inner trough height
- H_{Ra} = Outer trough height
- B_{Ri} = Inner trough width ▶ depends on dim. B_a
- B_{Ra} = Outer trough width
- n_{Mon} = Number of installation sets (left/right)
- n_{Ri} = Number of troughs sets (left/right)
- $H_{Ri} \geq 2 \cdot h_a$
- $B_{Ri} \geq B_a + 4$
- = Guide trough set ● = Glide bar
- = Installation set "Basic" ● = C-profile

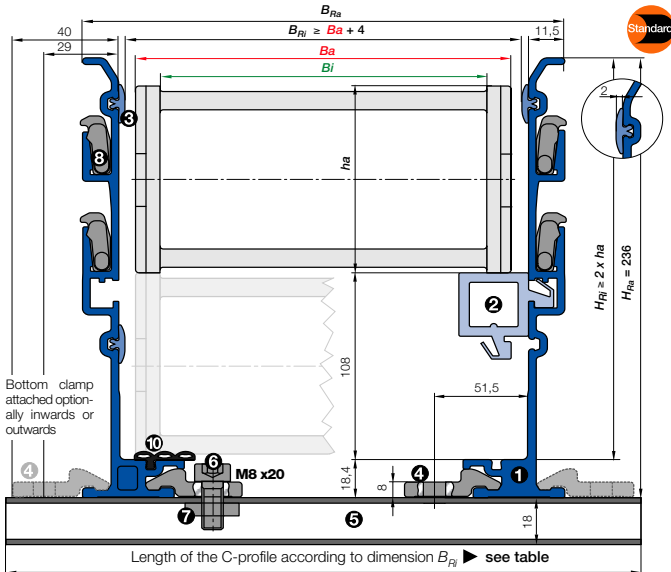

Phone+49- (0) 22 03-96 49-800
Fax +49- (0) 22 03-96 49-222

Installation set "Basic" with C-profile

Bottom Clamp attached optionally inwards or outwards

15050.30.300.0 ▶ Order example

	Part No.	
	B_{Ri} attached [mm]	attached
.06	84	-
.06	99	-
.07	109	-
.08	121	-
.10	134	-
.11	146	960.50.200
.12	159	960.50.225
.13	171	960.50.225
.15	184	960.50.250
.16	196	960.50.250
.17	209	960.50.275
.18	221	960.50.275
.20	234	960.50.300
.21	246	960.50.300
.22	259	960.50.325
.23	271	960.50.325
.25	284	960.50.350
.26	296	960.50.350
.27	309	960.50.375
.28	321	960.50.375
.30	334	960.50.400
.31	346	960.50.400
.32	359	960.50.425
.33	371	960.50.425
.35	384	960.50.450
.36	396	960.50.450
.37	409	960.50.475
.38	421	960.50.475
.40	434	960.50.500
.41	446	960.50.500
.42	459	960.50.525
.43	471	960.50.525
.45	484	960.50.550
.46	496	960.50.550
.47	509	960.50.575
.48	521	960.50.575
.50	534	960.50.600
.51	546	960.50.600
.52	559	960.50.625
.53	571	960.50.625
.55	584	960.50.650
.60	634	960.50.700



- **Components, trough "Basic":** ① Trough side parts, aluminum, 2 m ② Glide bar, plastic, 2 m ③ Glide strips, plastic, 2 m (without glide strips on request) ⑩ Optional: Silencer profile, rubber
- **Components, installation set "Basic":** ④ Bottom clamp, aluminum ⑤ C-profile, steel galvanized ⑥ Screw M8 x20 ⑦ Sliding nut M8 ⑧ Interface connector, plastic



Order example: Length of travel 30 m -
Center mounted for Series 15050.30.300.0 with $B_{Ri} = 334$

- Guide trough set (set of 2 trough side parts, incl. glide strips) **without** glide bar
Order text: 16 m guide trough without glide bar (8 x 2 m sections) **Part No. 975.30.SL**
- Guide trough set (set of 2 trough side parts, incl. glide strips) **with** glide bar
Order text: 16 m guide trough with glide bar (8 x 2 m sections) **Part No. 975.31.SL**
- Installation set "Basic" complete (guide trough-sets + 1)
Order text: 17 installation sets "Basic" **Part No. 960.50.400**
- Module for the fixed end
Order text: 1 set **Part No. 975.80**
- Option:** For an additional noise dampening with silencer profile, please add Index A - Example: **Part No. 975.30.SLA**

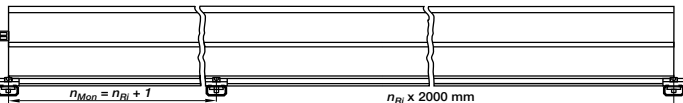

Principle sketch: Number of installation sets to be installed = Number of trough sections + 1



A quick fix for mounting the stationary end of an E-Chain®

With this module for the fixed end, fast and easy mounting onto the Aluminum "SuperTrough" is now possible without any drilling. Fast mounting of the E-Chain® by clamping onto the aluminum trough

- Quick relocation of the stationary end
- No drilling necessary ▶ page 9.16

Internet: www.igus.eu
E-mail: info@igus.de



Spray-painting robot with System E4 E-Chain® used in an ATEX version made of igumid ESD. High accelerations of up to 6 m/s² and high braking rates with a weight of the robot of approx. one ton



System E4/light
Inner height: 80 mm

Phone +49- (0) 22 03-96 49-800
Fax +49- (0) 22 03-96 49-222



► Chapter 9



► page 7.123



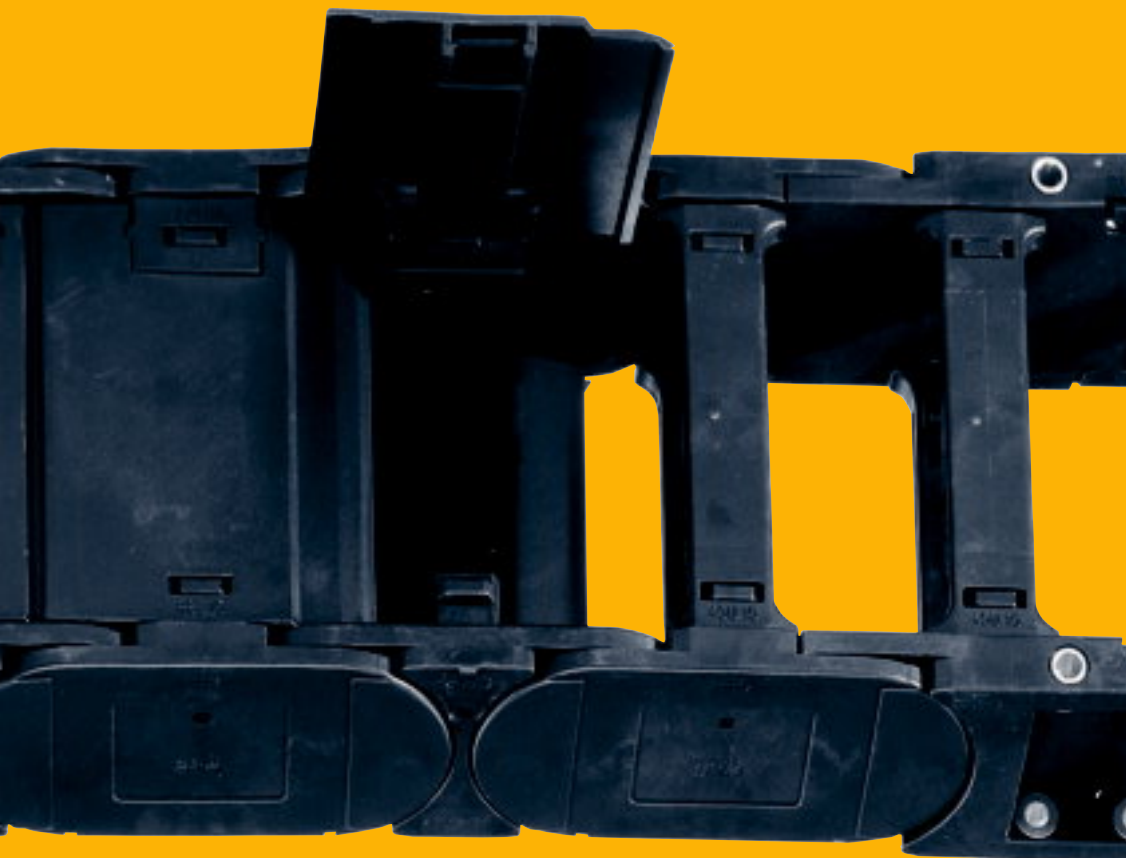

E4/00

For new designs: E4.1

E4/00 - The E4.1- predecessor for smooth running and easy assembly

E4/00 (pronounced: E4-hundred) - Its "inner link - outer link" design makes it easy to assemble and disassemble on site. The "noise buffer" design feature reduces operating noises noticeably. The system E4/00 is furthermore available from stock

Typical industries and applications

- Robotics and handling
- Material handling
- Freezing environment
- Construction machinery
- Machine tools
- Woodworking machinery
- Machines of all kinds
- Semicon
- Cleanroom
- Welding machines
- General machinery



IPA Certificate, Cleanroom ISO Class 3 (DIN 14644-1) at $v = 1$ m/s for Series 280.10.100.0 tested with igus® Chainflex® cables



ESD/ATEX upon request



Low-noise due to special rubber pads design



System E4/00 proved for long travels



System E4 - 4-piece design link





Long unsupported spans, high stability



Quiet and strong - ideal for handling applications



Sturdy design for construction machines

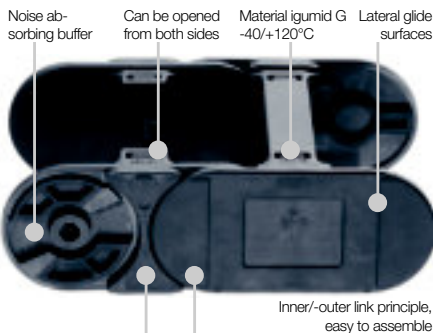

E4/00: E-Chains® with a 4-piece design link

- Lowest noise in its class
- Further noise reduction with rubber pads (Series E4/101)
- Broad application spectrum
- Numerous interior separation possibilities
- Broad system of modular accessories
- Widths up to 3000 mm using extension links
- Maximum stability in the igus® range
- Can be opened along both radii
- Max. travel: 200 - 400 m
- You can find more technical data about the material, chemical resistance, temperatures ► **Design, from page 1.38**

Selection table

Series	Inner height <i>hi</i> [mm]	Inner width <i>Bi</i> [mm]	Outer width <i>Ba</i> [mm]	Outer height <i>ha</i> [mm]	Bending radius <i>R</i> [mm]	Unsupported length max. [m]	page
--------	--------------------------------	-------------------------------	-------------------------------	--------------------------------	---------------------------------	-----------------------------	------

Crossbars every link for particularly demanding applications



220	28	40 - 300	60 - 320	42	55 - 250	2,00	7.162
280	32	50 - 400	73 - 423	54	63 - 300	3,00	7.170
380	42	50 - 400	76 - 426	64	75 - 350	3,80	7.180
400	56	50 - 600	84 - 634	84	135 - 500	4,50	7.190
600	108	200 - 600	252 - 652	140	200 - 1000	7,00	7.200
640	112	87 - 562	139 - 614	140	200 - 1000	7,00	7.208

Crossbars every 2nd link for almost all applications



290	32	50 - 400	73 - 423	54	63 - 300	3,00	7.170
390	42	50 - 400	76 - 426	64	75 - 350	3,80	7.180
410	56	50 - 600	84 - 634	84	135 - 500	4,50	7.190
601	108	200 - 600	252 - 652	140	200 - 1000	7,00	7.200

E-Tubes fully enclosed, excellent cable protection



R760	28	50 - 300	70 - 320	42	75 - 250	2,00	7.162
R770	32	50 - 300	73 - 323	54	125 - 300	3,00	7.170
R780	42	50 - 300	76 - 326	64	125 - 350	3,80	7.180
R880	56	75 - 462	109 - 497	84	150 - 500	4,50	7.190
R608	108	200 - 400	252 - 452	140	250 - 1000	7,00	7.200

System E4/00 | E-Chains® | Opening



Remove crossbars - Insert screwdriver into the slot, push down, release by lever action

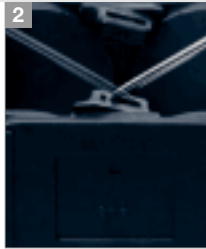

Clip demontieren - Schraubendreher ansetzen und aufhebeln

System E4/00 | E-Tubes | Opening



Remove lids/bottoms - Insert screwdriver into the slot, release by lever action

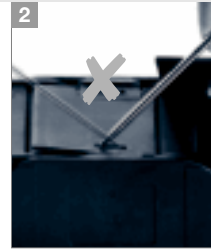

Release **only one side** to swivel the lid

System E4/00 | E-Chains® and E-Tubes | Assembling



Line up two inner side links, side by side. Attach an outer side link between

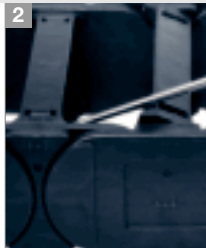

Assemble crossbars - Push down and snap in by using a screwdriver



Assemble clips (E-Chains® with crossbars every other link) - Push down and snap in

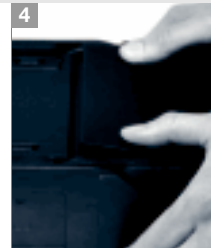

Assemble E-Tube lids/bottoms - Attach to the connector at an angle - Snap in

System E4/00 | E-Chains® and E-Tubes | Separating



Remove crossbars, clips, lids and bottoms at the outer links...



...guide the screwdriver into the slot between side links and release it by levering ...



...remove the outer links to the side...

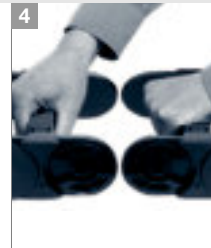

...and separate the E-Chain®

Price index



Series 220

Series R760



Low noise version E4/101
Series 221 available with
special rubber pads design



Cleanroom test
upon request



ESD classification:
Electrically conductive ESD/ATEX
version upon request



Opening E-Chains: Remove crossbars and clips - Insert screwdriver into the slot, push down, release by lever action



Remove lids/bottoms (E-Tubes) - Insert screwdriver into the slot, release by lever action



When to use the Series 220/R760:

- If a low-noise version is required
- At very high speeds and/or accelerations
- For long travels
- For high additional loads



When not to use it:

- Zig-zag lift applications
 - ▶ System E4/4, from page 7.218
- For side-mounted applications
 - ▶ System E4/4, from page 7.218
- If an extrem vibration-free E-Chain® is necessary
 - ▶ Series E6.29/R6.29, page 8.40/8.46

- ❶ Crossbars are removable along both radii
- ❷ Wide, rounded plastic crossbars - cable friendly
- ❸ Stop dog with "brake" for noise reduction
- ❹ Closed and open styles can be combined
- ❺ Hinged snap-open removable lids along outer radius of E-Tube
- ❻ Optimized glide pads
- ❼ Numerous interior separation possibilities
- ❽ KMA mounting brackets with attachment points on all sides
- ❾ Locking or pivoting mounting brackets available
- ❿ Integrated strain relief possible
- ⓫ E-Chains® also available with reverse bending radius "RBR"

Also available as
E4/00-NC without
camber: 220-NC

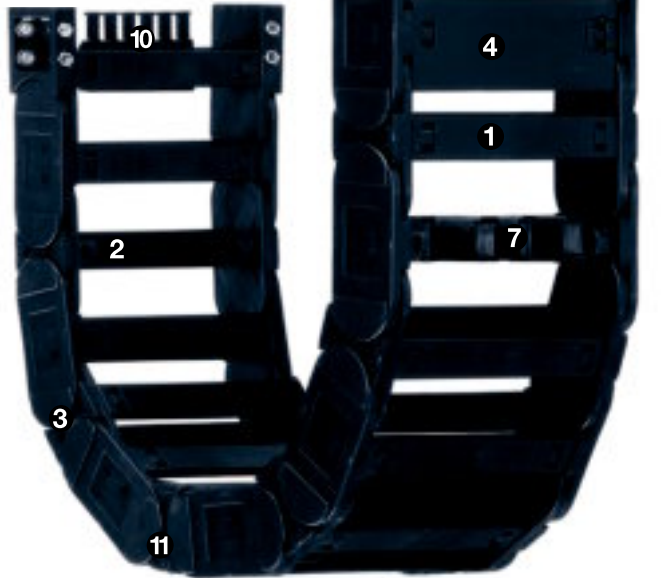

Order example complete E-Chain®

Please indicate chain-lengths or number of links Example: 3 m or 66 links

3 m 220.300.250.0

E-Chain®

with 2 separators 2211 assembled every 2" link

Interior separation

1 set 220.300.1.12

Mounting bracket



Unsupported length

FL_G = with straight upper run

FL_B = with permitted sag

Further information ► **Design, page 1.12**

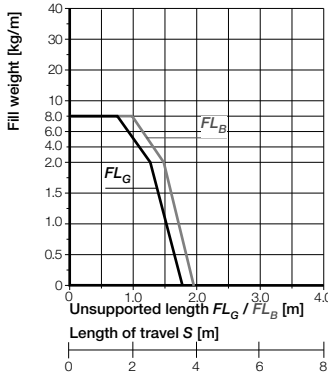
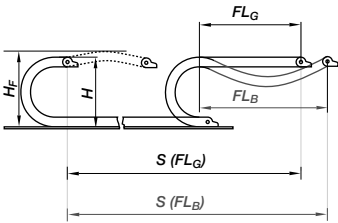

- S = Length of travel
 - R = Bending radius
 - H = Nominal clearance height
 - H_F = Required clearance height
 - H_{R1} = Trough inner height
 - D = Overlength E-Chain® radius in final position
 - $K = \pi \cdot R + \text{"safety"}$
 - D_2 = Over length - long travels, gliding
 - K_2 = *Further add-on
 - H_2 = *Mounting height
- *if the mounting bracket location is set lower

Other installation methods

- Vertical, hanging ≤ 80 m
- Vertical, standing ≤ 5 m
- Side mounted, un supp. ≤ 2 m
- Rotary requires further calculation
- Unsupported length of upper run = upon request



Short travels - unsupported

Unsupported E-Chains® feature positive camber over short travels. This must be accounted for when specifying the clearance height H_F . Please consult igus® if space is particularly restricted.

The required clearance height:
 $H_F = H + 40$ mm
(with 1,0 kg/m fill weight)

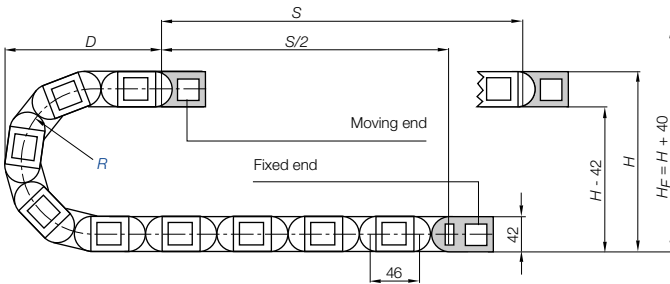

Pitch = 46 mm/link Links/m = 22 (1012 mm) Chain length = $S/2 + K$

R	055*	063*	075	100	125	150	175	200	250
H	154	170	194	244	294	344	394	444	544
D	125	133	145	170	195	220	245	270	320
K	265	290	330	410	485	565	645	725	880
H ₂	154	170	194	158	158	158	158	158	158
D ₂ *25	125	133	145	350	490	530	655	730	935
K ₂	265	290	330	598	782	920	1104	1242	1610

*not available for R760

Long travel lengths from 10 m to max. 200 m Chain length = $S/2 + K_2$

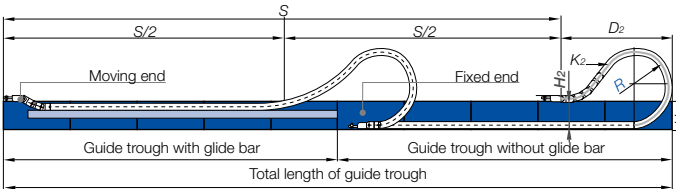

In case of travels between 4 and 10 m we recommend a longer unsupported length.



Gliding, long travel applications (max. 200 m)

In this case the E-Chain® upper run will be introduced in a guide trough on the lower run. We recommend to realize the engineering of such a plant by our technicians.

Technical Data

Speed / acceleration FL_G	max. 20 [m/s] / max. 200 [m/s]
Speed / acceleration FL_B	max. 3 [m/s] / max. 6 [m/s]
Gliding speed / acceleration (maximum)	max. 10 [m/s] / max. 50 [m/s]
Material - permitted temperature °C	igumid G / -40° up to +120° C
Flammability class, igumid G	VDE 0304 IIC UL94 HB



Details of material properties
► **page 1.38**

For support of the lower run - Support Tray tool kit available ► page 9.70

28

System E4/00
Inner height: 28 mm

Phone +49- (0) 22 03-96 49-800
Fax +49- (0) 22 03-96 49-222



► **page 7.161**

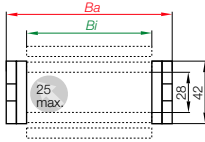

Part No. structure

220. 300. **250.** 0



Series 220 - E-Chain® with crossbars every link



- Robust solution with crossbars every link
- Can be opened from two sides
- Removable crossbars

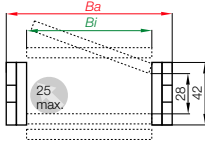

Part No. structure

760. 300. **250.** 0



Series R760 - Fully enclosed E-Tube



- Fully enclosed
- Excellent cable protection against dirt
- Protection against hot chips (up to 900°C)
- Lids along the entire inner radius are completely removable. Lids along the entire outer radius are single sided snap-open with a hinge on the other side to keep them attached to the chain or completely removable.



Low-noise! Special low-noise version with rubber pads

Series 221 - Order example 221.100.250.0

Further information:

www.igus.de or phone +49-0 22 03-96 49-800

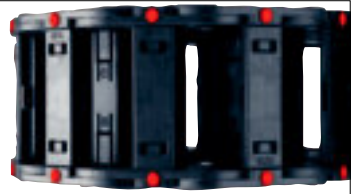

Part No.	<i>Bi</i>	<i>Ba</i>	220	R760
	[mm]	[mm]	[kg/m]	[kg/m]
220.040.....	40	60	≈ 1,06	-
220/760.050.....	50	70	≈ 1,10	≈ 1,25
220.062.....	62	82	≈ 1,14	-
220.070.....	70	90	≈ 1,18	-
220/760.075.....	75	95	≈ 1,21	≈ 1,44
220.087.....	87	107	≈ 1,27	-
220/760.100.....	100	120	≈ 1,32	≈ 1,64
220/760.125.....	125	145	≈ 1,43	≈ 1,84
220/760.150.....	150	170	≈ 1,54	≈ 2,02
220/760.175.....	175	195	≈ 1,65	≈ 2,26
220/760.200.....	200	220	≈ 1,76	≈ 2,40
220/760.225.....	225	245	≈ 1,87	≈ 2,56
220/760.250.....	250	270	≈ 1,98	≈ 2,85
220.275.....	275	295	≈ 2,09	-
220/760.300.....	300	320	≈ 2,20	≈ 3,21

Hot Chips up to 850°C

E-Tubes that repel hot chips, up to 850°C. Some applications, depending on amount and size of the chips, can burn or melt the surface. That is no longer the case with the igus® "Iguimid HT" material. Order example: **Full E-Tube made of HT: 760.050.150.0.HT**
Lids made of HT: **760.050.HTE.150.0**
*for long travels upon request
Further Information: www.igus.de/en/HT
Delivery time up to 4 weeks!

System E4/00
Inner height: 28 mm

Phone +49- (0) 22 03-96 49-800
Fax +49- (0) 22 03-96 49-222

Available bending radii

R [mm] 055° 063° 075 100 125 150 175 200 250

Supplement Part No. with required radius. Example: 220.300.250.0

0 = standard color, other colors ▶ page 1.39 · Pitch = 46 mm/link - Links/m = 22

*not available for R760

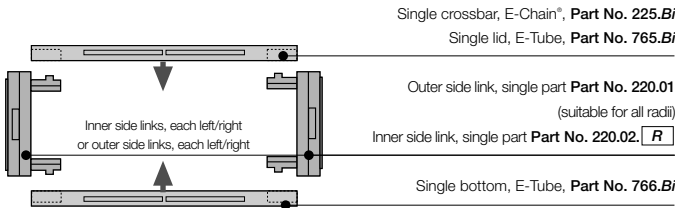

Part No. E-Chain® links, single parts

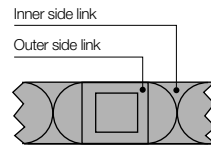

▶ page 7.161



Vertical separators are used if a vertical subdivision is required. In the standard configuration, a separator is mounted at every second link. **Note:** Observe a lateral spacing of at least 20 mm (E-Tube)!

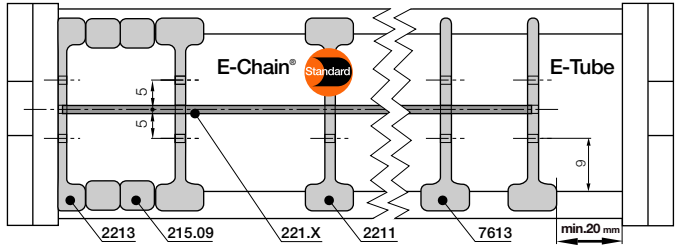

Vertical separator
2201



Vertical separator
7603



Spacer
205.09



Side plate
2203



Full-width shelf 220.X

Full-width shelf

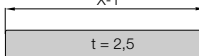

Vertical separator for E-Chains*	
unassembled	2201
assembled	2211



Vertical separator for E-Tubes	
unassembled	7603
assembled	7613

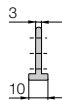

Spacer* for E-Chains*	
unassembled	205.09
assembled	215.09



Side plate for E-Chains*	
unassembled	2203
assembled	2213



*For side-mounted applications

Option 1: Vertical separators and spacers

● **Standard separator 2201 for E-Chains®** is used when vertical and horizontal separation is required. Due to its slot, it allows basic vertical/horizontal shelving arrangements.

● **Vertical separator 7603 for E-Tubes R760.**

● Separators (e.g. "side mounted") for E-Chains® can be fixed in their position with **spacers 205.09**. The available inner height will be reduced by 2 mm, per spacer and side. To avoid this, the parts can be assembled on outside of the crossbar (not for long travels)

Additionally:

● **Side plate 2203 and full-width shelf 220.X** - this option makes sense in applications with many thin cables with similar diameters. It is based upon **vertical separator 2201 (7603)** for the Series **R760 E-Tube** is put in place and the shelf is inserted into the separator's slots. If no separators are desired, **side plate 2203** must be used with the **Series 220 E-Chain®**. This solution is not available for E-Tubes.

Width X [mm]	Part No. unassembled	Part No. assembled
040	220.40	221.40
050	220.50	221.50
062	220.62	221.62
070	220.70	221.70
075	220.75	221.75
087	220.87	221.87

Width X [mm]	Part No. unassembled	Part No. assembled
100	220.100	221.100
125	220.125	221.125
150	220.150	221.150
175	220.175	221.175
200	220.200	221.200

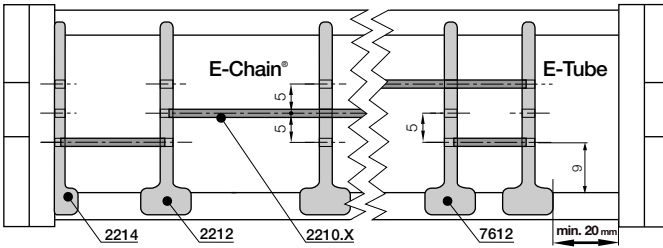

For use with many cables of differing diameters. E-Chains* and E-Tubes can be subdivided both vertically and horizontally. The shelves can be arranged elevator-shifted with different bottoms

Option 2: Shelves

● Side plates 2204, middle plates 2202 and shelves 2200.X form the basic pattern of a shelf system. Shelves of various widths can be arranged at 3 different heights (in 5 mm increments).

● A middle plate 7602 is available for the E-Tube. Side plates are not available for the E-Tube.

	Side plate for E-Chains*	
	unassembled	2204
	assembled	2214

	Middle plate for E-Chains*	
	unassembled	2202
	assembled	2212

	Middle plate for E-Tubes	
	unassembled	7602
	assembled	7612

Width X [mm]	Part No. unassembled	Part No. assembled
018	2200.18	2210.18
023	2200.23	2210.23
028	2200.28	2210.28
033	2200.33	2210.33
038	2200.38	2210.38
043	2200.43	2210.43
048	2200.48	2210.48

Width X [mm]	Part No. unassembled	Part No. assembled
058	2200.58	2210.58
068	2200.68	2210.68
073	2200.73	2210.73
088	2200.88	2210.88
099	2200.99	2210.99
124	2200.124	2210.124
149	2200.149	2210.149



Side plate 2204



Middle plate 2202



Middle plate 7602



Shelf 2200.X

Shelf

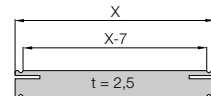

System E4/00
Inner height: 28 mm

Phone +49- (0) 22 03-96 49-800
Fax +49- (0) 22 03-96 49-222



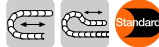

The Standard - Option KMA* - pivoting

- Recommended for unsupported and gliding applications
- Universal mountable with attachment capability on all sides
- Bolted connection outside of chain cross-section
- Confined installation conditions
- Corrosion resistant

*KMA = Polymer Metal Mounting Bracket

Moving end
2200/7600...□.2

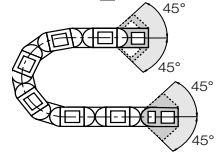

Fixed end

2200/7600...□.1

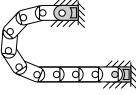

The attachment variants arising automatically by the choice of the KMA mounting bracket

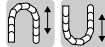

Option KMA - locking

- Recommended for vertical hanging / standing applications
- Universally mountable
- Corrosion resistant
- Locked connections
- At very high acceleration

Moving end
2300/7650...□.2

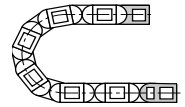

Fixed end

2300/7650...□.1

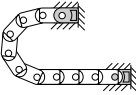

The attachment variants arising automatically by the choice of the KMA mounting bracket

Dimensions and order configurations

Part No. structure (pivoting)

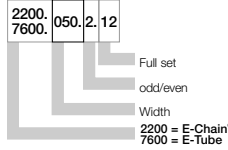

Part No. structure (locking)

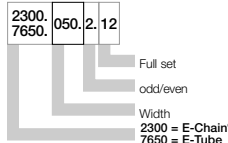

Note: The E4/00 System may end with either an inner side or an outer side link. Keep in mind that an outer side link always forms the first chain link at the moving end. The Part No. depends on an even or odd numbers of links. Please insert: **1** for odd number of links or **2** for even number of links

Full set, for both ends:

2200.040.2.12 (even)

Single-part order:

2200.040.2.2 (even)

Mounting bracket moving end

2200.040.2.1 (even)

Mounting bracket fixed end

Fixed end

2200/7600...□.1 (pivoting)

2300/7650...□.1 (locking)

Moving end

(pivoting) 2200/7600...□.2

(locking) 2300/7650...□.2

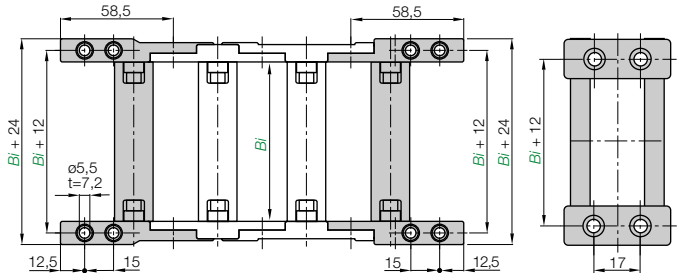

Width index			Part No. full set			Bi [mm]			
	pivoting	locking		pivoting	locking		pivoting	locking	
.040	▶ 2200	2300	.040.□.12	40	.150	▶ 2200/7600	2300/7650	.150.□.12	150
.050	▶ 2200/7600	2300/7650	.050.□.12	50	.175	▶ 2200/7600	2300/7650	.175.□.12	175
.062	▶ 2200	2300	.062.□.12	62	.200	▶ 2200/7600	2300/7650	.200.□.12	200
.070	▶ 2200	2300	.070.□.12	70	.225	▶ 2200/7600	2300/7650	.225.□.12	225
.075	▶ 2200/7600	2300/7650	.075.□.12	75	.250	▶ 2200/7600	2300/7650	.250.□.12	250
.087	▶ 2200	2300	.087.□.12	87	.275	▶ 2200	2300	.275.□.12	275
.100	▶ 2200/7600	2300/7650	.100.□.12	100	.300	▶ 2200/7600	2300/7650	.300.□.12	300
.125	▶ 2200/7600	2300/7650	.125.□.12	125					

Please insert **1** for odd number of links or **2** for even number of links

E4/00 | Series 220-R760 | Accessories | Strain Relief



Strain relief tie-wrap plate Part No. 2050.Z can be fixed on the last crossbar. **Details ▶ chapter 10**

Part No.	Width [mm]	Number of teeth
2050.Z	60	6

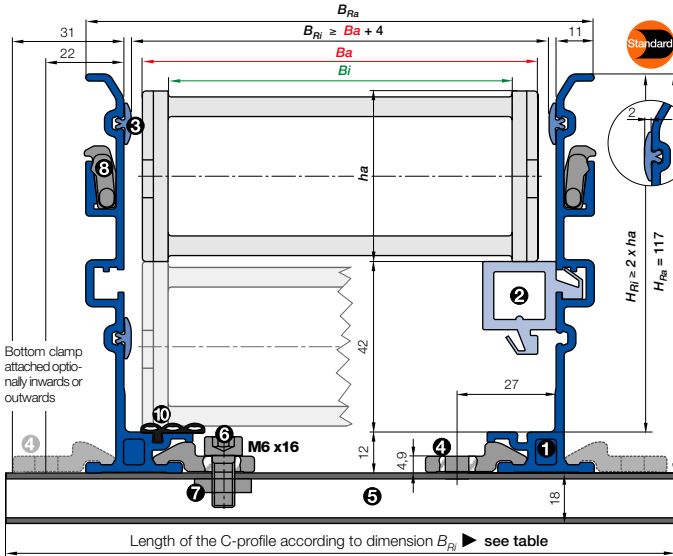

- B_a = Outer width E-Chains® / E-Tube
 - B_i = Inner width E-Chains® / E-Tube
 - h_a = Outer height E-Chains® / E-Tube
 - H_{Ri} = Inner trough height
 - H_{Ra} = Outer trough height
 - B_{Ri} = Inner trough width ▶ depends on dim. B_a
 - B_{Ra} = Outer trough width
 - n_{Mon} = Number of installation sets (left/right)
 - n_{Ri} = Number of trough sets (left/right)
 - $H_{Ri} \geq 2 \cdot h_a$
 - $B_{Ri} \geq B_a + 4$
- = Guide trough set ● = Guide bar
 - = Installation set "Basic" ● = C-profile

Installation set "Basic" with C-profile

Bottom Clamp attached optionally inwards or outwards

220.070.250.0 ▶ Order example

B_{Ri} [mm]	Part No.	
	attached inwards	attached outwards
.040	64	960.30.175
.050	74	960.30.125 960.30.175
.062	86	960.30.150 960.30.200
.070	94	960.30.150 960.30.200
.075	99	960.30.150 960.30.200
.087	111	960.30.175 960.30.225
.100	124	960.30.175 960.30.225
.125	149	960.30.200 960.30.250
.150	174	960.30.225 960.30.275
.175	199	960.30.250 960.30.300
.200	224	960.30.275 960.30.325
.225	249	960.30.300 960.30.350
.250	274	960.30.325 960.30.375
.275	299	960.30.350 960.30.400
.300	324	960.30.375 960.30.425



- **Components, trough "Basic":** ① Trough side parts, aluminum, 2 m ② Glide bar, plastic, 2 m ③ Glide strips, plastic, 2 m (without glide strips on request) ⑩ Optional: Silencer profile, rubber
- **Components, installation set "Basic":** ④ Bottom clamp, aluminum ⑤ C-profile, steel galvanized ⑥ Screw M6 x16 ⑦ Sliding nut M6 ⑧ Interface connector, plastic

Order example: Length of travel 30 m - Center mounted for Series 220.070.250.0 with $B_{Ri} = 94$

- Guide trough set (set of 2 trough side parts, incl. glide strips) **without** glide bar
Order text: 16 m guide trough without glide bar (8 x 2 m sections) Part No. 972.02.30.SL
- Guide trough set (set of 2 trough side parts, incl. glide strips) **with** glide bar
Order text: 16 m guide trough with glide bar (8 x 2 m sections) Part No. 972.02.31.SL
- Installation set "Basic" complete (guide trough-sets + 1)
Order text: 17 installation sets "Basic" Part No. 960.30.150
- Module for the fixed end
Order text: 1 set Part No. 972.82
- Option:** For an additional noise dampening with silencer profile, please add Index A - Example: **Part No. 972.02.30.SLA**

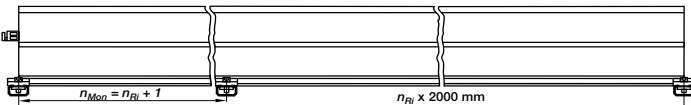

Principle sketch: Number of installation sets to be installed = Number of trough sections + 1



A quick fix for mounting the stationary end of an E-Chain®

With this module for the fixed end, fast and easy mounting onto the Aluminum "SuperTrough" is now possible without any drilling. Fast mounting of the E-Chain® by clamping onto the aluminum trough

- Quick relocation of the stationary end
- No drilling necessary

Insert for the installation set "Heavy-Duty": **972.50.XXX** instead of (960.30.XXX) on the right column "attached outwards"

Phone +49- (0) 22 03-96 49-800
Fax +49- (0) 22 03-96 49-222



Price index



Low noise version E4/101
Series 281 available with
special rubber pads design



IPA Certificate, Cleanroom ISO
Class 3 at v=1 m/s and ISO Class
4 at v=2 m/s for Series 280.10.100.0



ESD classification:
Electrically conductive ESD/ATEX
version upon request



Opening E-Chains: Remove crossbars and
clips - Insert screwdriver into the slot, push
down, release by lever action



Remove lids/bottoms (E-Tubes) - Insert screw-
driver into the slot, release by lever action



When to use the Series 280/290/R770:

- If a low-noise version is required
- At very high speeds and/or accelerations
- For long travels
- For high additional loads
- Also available without camber



When not to use it:

- If long side-mounted, unsupported length is required
▶ Series E4.32, page 7.34
- If an extrem vibration-free E-Chain[®] is necessary
▶ Series E6.35, page 8.50

- ❶ Crossbars on E-Chain[®] removable along both radii
- ❷ Numerous interior separation possibilities
- ❸ Closed and open styles can be combined
- ❹ Stop dog with "brake" for noise reduction
- ❺ Optimized glide pads
- ❻ Wide, rounded plastic crossbars - cable friendly
- ❼ Hinged snap-open removable lids along outer radius of E-Tube
- ❽ KMA mounting brackets with attachment points on all sides
- ❾ Locking or pivoting mounting brackets available
- ❿ Integrated strain relief with C-profile option
- ⓫ E-Chains[®] also available with reverse bending radius "RBR"



Also available as
E4/00-NC without
camber: 280-NC

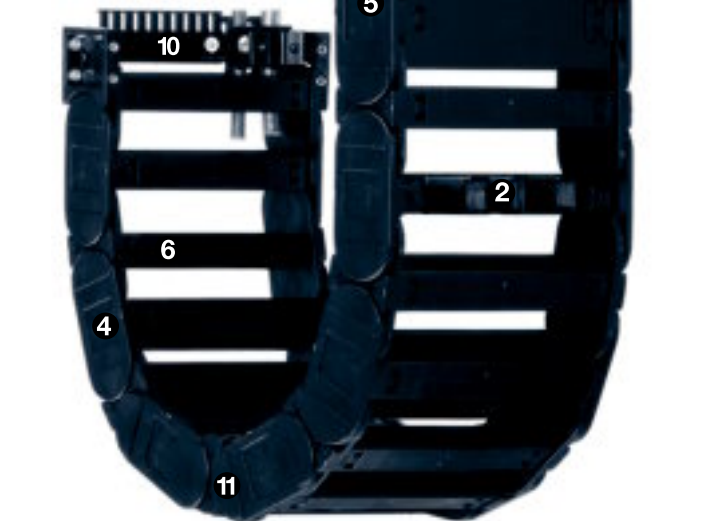

Order example complete E-Chain[®]

Please indicate chain-lengths or number of links Example: 4 m or 72 links

4 m 280.30.300.0

E-Chain[®]

with 2 separators 282 assembled every 2nd link

Interior separation

1 set 280.30.1.12.C

Mounting bracket



Unsupported length

FL_G = with straight upper run

FL_B = with permitted sag

Further information ► **Design, page 1.12**

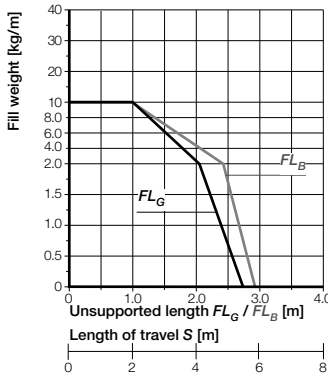
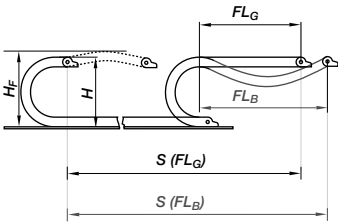

- S = Length of travel
- R = Bending radius
- H = Nominal clearance height
- H_F = Required clearance height
- H_{R1} = Trough inner height
- D = Overlength E-Chain*
radius in final position
- $K = \pi \cdot R + \text{"safety"}$
- D_2 = Over length - long travels, gliding
- K_2 = *Further add-on
- H_2 = *Mounting height
- *If the mounting bracket location is set lower

Other installation methods

- Vertical, hanging ≤ 80 m
- Vertical, standing ≤ 5 m
- Side mounted, un supp. $\leq 1,5$ m
- Rotary requires further calculation
- Unsupported length of upper run = upon request

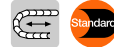

Short travels - unsupported

Unsupported E-Chains* feature positive camber over short travels. This must be accounted for when specifying the clearance height H_F . Please consult igus* if space is particularly restricted.

The required clearance height:

$H_F = H + 40$ mm
(with 2,0 kg/m fill weight)

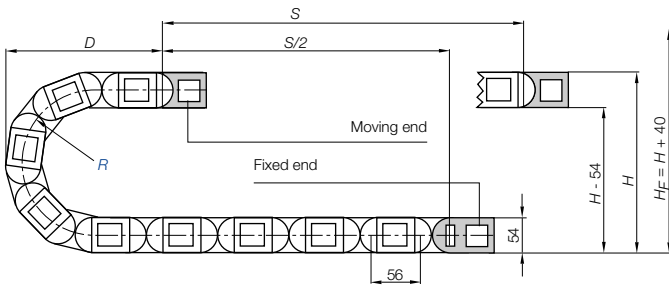

Pitch = 56 mm/link Links/m = 18 (1008 mm) Chain length = $S/2 + K$

R	063	075	100	125	150	175	200	220	250	300
$H + 20$	180	205	255	305	355	405	455	495	555	655
D	146	158	183	208	233	258	283	303	333	383
K	310	350	430	505	585	665	745	805	900	1055
H_2	180	205	166	166	166	166	166	166	166	166
$D_2 + 25$	146	158	370	470	500	655	770	900	930	1100
K_2	310	350	616	784	896	1120	1288	1456	1568	1904

Long travel lengths from 10 m to max. 200 m Chain length = $S/2 + K_2$

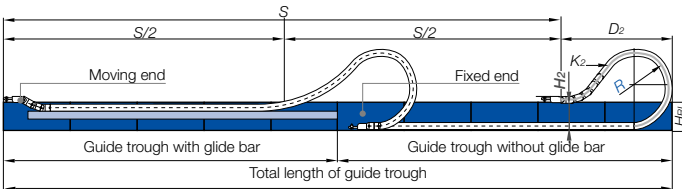

In case of travels between 4 and 10 m we recommend a longer unsupported length.



Gliding, long travel applications (max. 200 m)

In this case the E-Chain* upper run will be introduced in a guide trough on the lower run. We recommend to realize the engineering of such a plant by our technicians.

Technical Data

Speed / acceleration FL_G	max. 20 [m/s] / max. 200 [m/s ²]
Speed / acceleration FL_B	max. 3 [m/s] / max. 6 [m/s ²]
Gliding speed / acceleration (maximum)	max. 10 [m/s] / max. 50 [m/s ²]
Material - permitted temperature °C	igumid G / -40° up to +120° C
Flammability class, igumid G	VDE 0304 IIC UL94 HB



Details of material properties
► page 1.38

For support of the lower run - **Support Tray tool kit** available ► page 9.70

32

System E4/00
Inner height: 32 mm

Phone +49- (0) 22 03-96 49-800
Fax +49- (0) 22 03-96 49-222

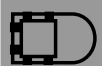

► page 7.161

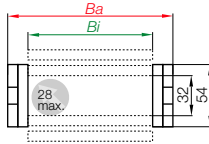

Part No. structure

280. 30. 300. 0



Series 280 - E-Chain® with crossbars every link

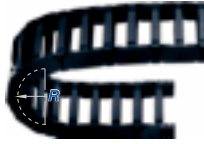

- Crossbars every link
- For rigid hydraulic hoses
- For applications particularly demanding
- Can be opened from two sides

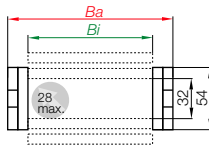

Part No. structure

290. 20. 300. 0



Standard Series 290 - E-Chain® with crossbars every 2nd link



- Crossbars every 2nd link = Standard
- For nearly every situation
- Can be opened from two sides
- Easy assembly
- Stable
- Attractive price

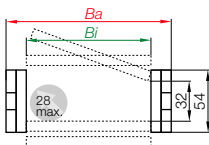

Part No. structure

770. 30. 300. 0



Series R770 - Fully enclosed E-Tube



- Fully enclosed
- Excellent cable protection against dirt
- Protection against hot chips (up to 900°C)
- Lids along the entire inner radius are completely removable. Lids along the entire outer radius are single sided snap-open with a hinge on the other side to keep them attached to the chain or completely removable.



Low-noise! Special low-noise version with rubber pads

Series 281 - Order example 281.10.250.0

Further information:

www.igus.de or phone +49-0 22 03-96 49-800

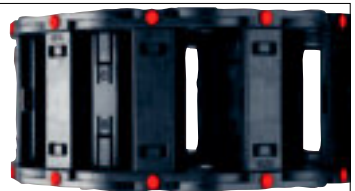

Part No.	Bi [mm]	Ba [mm]	280 [kg/m]	290 [kg/m]	R770 [kg/m]
280/290/770.05... []_0*	50	73	≈ 1,73	≈ 1,64	≈ 2,63
280/290.06... []_0	68	91	≈ 1,79	≈ 1,67	-
280/290/770.07... []_0	75	98	≈ 1,84	≈ 1,69	≈ 2,75
280/290.087... []_0	87	110	≈ 1,93	≈ 1,73	-
280/290/770.10... []_0	100	123	≈ 2,02	≈ 1,78	≈ 2,83
280/290/770.11... []_0	108	131	≈ 2,08	≈ 1,81	≈ 2,94
280/290.112... []_0	112	136	≈ 2,15	≈ 1,84	-
280/290/770.12... []_0	125	148	≈ 2,20	≈ 1,87	≈ 3,03
280/290.137... []_0	137	161	≈ 2,29	≈ 1,91	-
280/290/770.15... []_0	150	173	≈ 2,38	≈ 1,96	≈ 3,19
280/290.162... []_0	162	186	≈ 2,44	≈ 1,99	-
280/290/770.17... []_0	168	191	≈ 2,51	≈ 2,02	≈ 3,39
280/290.18... []_0	175	198	≈ 2,56	≈ 2,05	-
280/290.187... []_0	187	211	≈ 2,65	≈ 2,09	-
280/290/770.20... []_0	200	223	≈ 2,74	≈ 2,14	≈ 3,59
280/290.212... []_0	212	236	≈ 2,87	≈ 2,20	-
280/290.23... []_0	225	248	≈ 2,92	≈ 2,22	-
280/290.237... []_0	237	261	≈ 3,05	≈ 2,29	-
280/290/770.25... []_0	250	273	≈ 3,10	≈ 2,32	≈ 4,04
280/290.262... []_0	262	286	≈ 3,19	≈ 2,36	-
280/290.28... []_0	275	298	≈ 3,28	≈ 2,41	-
280/290.29... []_0	287	311	≈ 3,37	≈ 2,45	-
280/290/770.30... []_0	300	323	≈ 3,46	≈ 2,50	≈ 4,43
280/290.312... []_0	312	336	≈ 3,59	≈ 2,56	-
280/290.325... []_0	325	348	≈ 3,68	≈ 2,60	-
280/290.337... []_0	337	361	≈ 3,77	≈ 2,65	-
280/290.350... []_0	350	373	≈ 3,86	≈ 2,69	-
280/290.362... []_0	362	386	≈ 3,95	≈ 2,74	-
280/290.375... []_0	375	398	≈ 4,04	≈ 2,79	-
280/290.387... []_0	387	411	≈ 4,11	≈ 2,82	-
280/290.400... []_0	400	423	≈ 4,18	≈ 2,86	-

Available bending radii

R [mm] 063** 075** 100** 125 150 175 200 220 250 300

Supplement Part No. with required radius. Example: 280.30.300.0

0 = standard color, other colors ▶ page 1.39 · Pitch = 56 mm/link - Links/m = 18

*Removable lid only, no hinged option · **not available for R770

Hot Chips up to 850°C

E-Tubes that repel hot chips, up to 850°C. Some applications, depending on amount and size of the chips, can burn or melt the surface. That is no longer the case with the igus® "igumid HT" material. Order example: Full E-Tube made of HT:

770.30.150.0.HT
Lids made of HT:
770.30.HTE.150.0

*for long travels. Upon request
Further Information:
www.igus.de/en/HT
Delivery time
up to 4 weeks!



System E4/00
Inner height: 32 mm

Phone +49- (0) 22 03-96 49-800
Fax +49- (0) 22 03-96 49-222



Extender crossbar for large diameter hoses ▶ page 7.176

Single crossbar, E-Chain®, Part No. 385.Bi

Single lid, E-Tube, Part No. 775.Bi

Outer side link, single part Part No. 280.01

(suitable for all radii)

Inner side link, single part Part No. 280.02 [R

Single bottom, E-Tube, Part No. 776.Bi

Part No. E-Chain® links, single parts

Inner side link

Outer side link

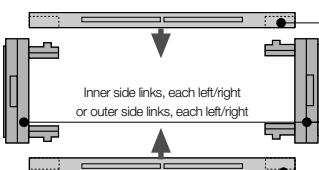
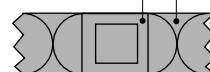

▶ page 7.161



Vertical separators are used if a vertical subdivision is required. In the standard configuration, a separator is mounted at every second link. **Note:** Observe a lateral spacing of at least 25 mm (E-Tube)!

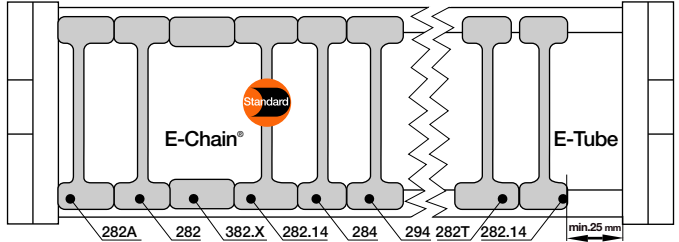

Vertical separator
281



Vertical separator
281T



Vertical separator
281.14



Vertical separator
283



Spacer
381.XX



Locking separator
293



Asymmetric
separator 281A

Vertical separator for E-Chains*	2,5
unassembled	281
assembled	282



Vertical separator for E-Tubes	2,5
unassembled	281T
assembled	282T



Vertical separator for E-Chains*/E-Tubes	2,5
unassembled	281.14
assembled	282.14



Vertical separator for E-Chains*	2,5
unassembled	283
assembled	284



Spacer*	2,5
for E-Chains*	
unassembled	381.XX
assembled	382.XX



Locking separator for E-Chains*	2,5
unassembled	293
assembled	294



Asymmetric separator for E-Chains*	2,5
unassembled	281A
assembled	282A



*For side-mounted applications

Option 1: Vertical separators and spacers

● **Standard separator 281 for E-Chains®** offers safe stability due to its broad foot design, also when used with thick cables or hoses. If the distance needed between separators is greater than this separator's dimension, we offer the **Vertical separator 281.14**.

● **Standard separator 281T for E-Chains®** offers safe stability due to its broad foot design, also when used with thick cables or hoses. If the distance needed between separators is greater than this separator's dimension, we offer the **Vertical separator 281.14**.

● **Vertical separator 283 with a narrow foot for E-Chains®** with applications where a large number of small cables need to be individually separated.

● Separators (e.g. "side mounted") for E-Chains® can be fixed in their position with **spacers 381.XX**. The available inner height will be reduced by 2 mm, per spacer and side. To avoid this, the parts can be assembled on outside of the crossbar (not for long travels)
XX = width of the spacer (available 10, 15 and 20).

Additionally:

● **Locking separator 293 for E-Chains®** - with increased retention force for applications exposed to very high humidity or extreme loads. The extra retention force is achieved by asymmetric claws for the crossbar. Ensure proper alignment (not for E-Tubes).

● **Asymmetric separator 281A for E-Chains®** (not for E-Tubes) with an 12-mm base, for combinations between spacers of different widths and vertical separators in side-mounted applications, for instance.

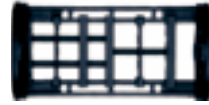
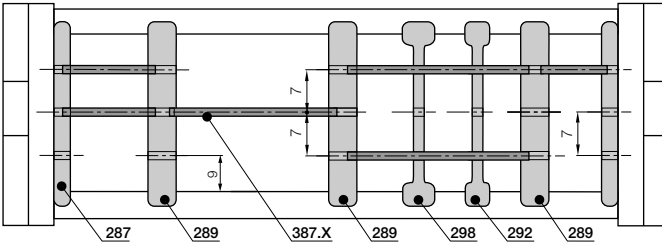

For use with many cables of differing diameters. E-Chains® and E-Tubes can be subdivided both vertically and horizontally. The shelves can be arranged elevator-shifted with different bottoms

Option 2: Shelves

● Side plates 286, middle plates 288 und shelves 386.X form the basic pattern of a shelf system. Shelves of various widths can be arranged at 3 different heights (in 7 mm increments).

● For special applications: Vertical separator with injection moulded shelf 281.S.57 (57,5 mm) or 281.S.45 (45 mm).

● Slotted separators 291 (not for E-Tubes), are used for very fine subdivisions. However, they cannot be retrofitted into an existing separation system without dismantling the interior separators first.

● The unilateral open, slotted separator 297 can be retrofitted into an existing interior separation system without a need for dismantling the interior separators. During an installation of open slotted separators, the top and bottom notches cannot be occupied by shelves.

Side plate for E-Chains®/E-Tubes	
unassembled	286
assembled	287

Middle plate for E-Chains®/E-Tubes	
unassembled	288
assembled	289

Vertical separator for E-Chains®/E-Tubes	
unassembled	281.S.57
assembled	282.S.57

Vertical separator for E-Chains®/E-Tubes	
unassembled	281.S.45
assembled	282.S.45

Slotted separator for E-Chains®	
unassembled	291
assembled	292

Open slotted separator for E-Chains®/E-Tubes	
unassembled	297
assembled	298

Width X [mm]	Part No. unassembled	Part No. assembled
018	386.18	387.18
023	386.23	387.23
025	386.25	387.25
028	386.28	387.28
033	386.33	387.33
043	386.43	387.43
050	386.50	387.50
054	386.54	387.54
062	386.62	387.62
075	386.75	387.75

Width X [mm]	Part No. unassembled	Part No. assembled
087	386.87	387.87
100	386.100	387.100
108	386.108	387.108
125	386.125	387.125
150	386.150	387.150
175	386.175	387.175
200	386.200	387.200
208	386.208	387.208
225	386.225	387.225



Side plate
286



Middle plate
288

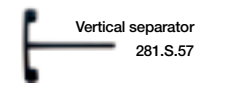

Vertical separator
281.S.57



Vertical separator
281.S.45



Slotted
separator
291

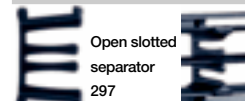

Open slotted
separator
297



Shelf 386.X

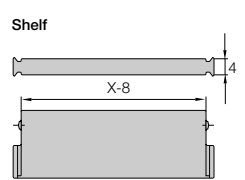

Shelf

System E4/00
Inner height: 32 mm

Phone +49- (0) 22 03-96 49-800
Fax +49- (0) 22 03-96 49-222

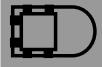



Extension links - for extremely wide E-Chains® up to 3,0 m

- For applications in which particularly high fill weights necessitate extremely wide E-Chains® (up to 3000 mm)
- The extension link design allows virtually limitless side-by-side attachment of chains
- The unsupported length of a chain can be increased when additional loads are required
- Extension links can be used with E-Chains®, E-Tubes or as a combination of both
- They are suitable for unsupported and gliding applications in a guide trough
- E-Chains® with extension links are attached with KMA or steel mounting brackets



Part No. structure
280.10 /20 /10. 200 ,0
280.Bi1/Bi2/Bi3. R ,0

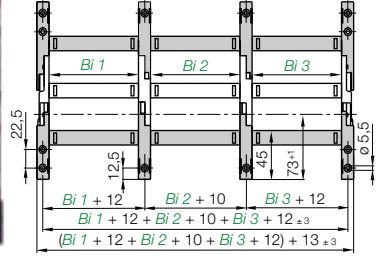

Extender crossbars - careful guide of hoses applications

- Suitable for hoses with a maximum outer diameter of 105 mm
- Gliding operation with crossbars assembled along the outer radius and a special guide trough
- Gliding operation not guaranteed with crossbars assembled along the inner radius
- The extender crossbar can either be attached to the side links directly or can be used in combination with two stranded snap-open crossbars

Consult igus® for your extender crossbar applications. We are happy to assist you with your design layout

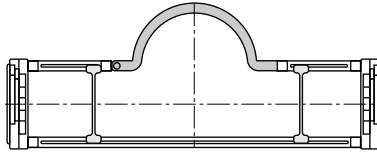

385.15RHD115 round extender crossbar combined with snap-open crossbars

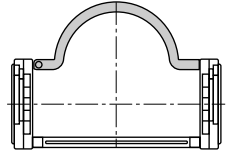

385.18RD115 round strap attached directly on the side link

Part No.	Max Ø [mm] hose	Form	Installation side link	Combination with snap-open crossb.
385.15.RHD115	105	○	-	+
385.18.RD115	105	○	+	-

○ = round + = yes / - = no



Hinged crossbars

- Typically E-Chain® crossbars are completely removable. In cases where the snap-open crossbars have to remain at the open link of the E-Chain®, a hinged design has been developed
- Length: 37,5 mm **Part No. 385.02** / snap-open crossbar (shortened): *Bi*-37,5 mm **Part No. 385.03**
- Please consult igus® for design assistance

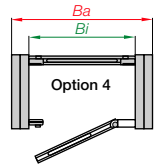
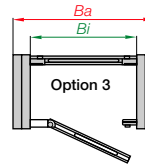
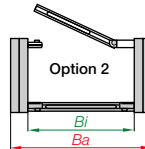
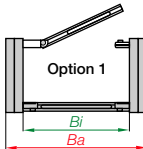
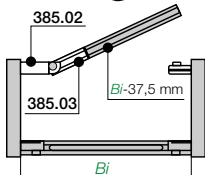

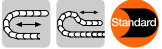

The Standard - Option KMA* - pivoting

- Recommended for unsupported and gliding applications
- Confined installation conditions
- Option - integrated C-profile strain relief device with Chainfix clip or strain relief tiwrap plates
- Corrosion resistant
- Universal mountable with attachment capability on all sides

*KMA = Polymer Metal Mounting Bracket

Moving end
2800/7700...□.2

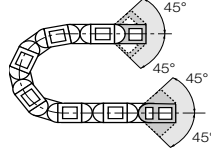

Fixed end
2800/7700...□.1



The attachment variants arising automatically by the choice of the KMA mounting bracket

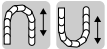
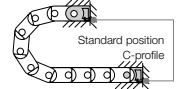

Option KMA - locking

- Recommended for vertical hanging / standing applications

Additionally:

- Universal mountable
- C-profile option
- Corrosion resistant
- Locked connections
- At very high acceleration

Moving end
2900/7750...□.2



Fixed end
2900/7750...□.1



The attachment variants arising automatically by the choice of the KMA mounting bracket

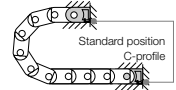

Fixed end

2800/7700...□.1 (pivoting)

2900/7750...□.1 (locking)

Moving end

(pivoting) 2800/7700...□.2

(locking) 2900/7750...□.2

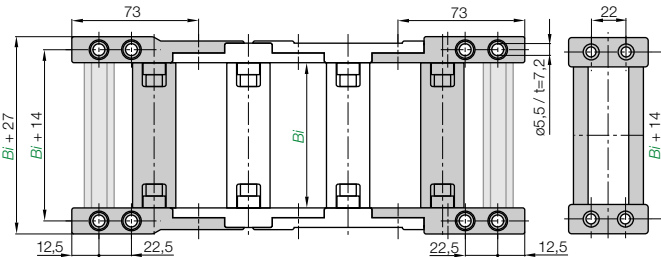

Width index	Part No. full set pivoting	locking	C-profile option [mm]	Bi	Width index	Part No. full set pivoting	locking	C-profile option [mm]	Bi
.05.	2800/7700	2900/7750	.05. □.12. □ 50	.23.	2800	2900	.23. □.12. □ 225		
.06.	2800	2900	.06. □.12. □ 68	.237.	2800	2900	.237. □.12. □ 237		
.07.	2800/7700	2900/7750	.07. □.12. □ 75	.25.	2800/7700	2900/7750	.25. □.12. □ 250		
.087.	2800	2900	.087. □.12. □ 87	.262.	2800	2900	.262. □.12. □ 262		
.10.	2800/7700	2900/7750	.10. □.12. □ 100	.28.	2800	2900	.28. □.12. □ 275		
.11.	2800/7700	2900/7750	.11. □.12. □ 108	.29.	2800	2900	.29. □.12. □ 287		
.112.	2800	2900	.112. □.12. □ 112	.30.	2800/7700	2900/7750	.30. □.12. □ 300		
.12.	2800/7700	2900/7750	.12. □.12. □ 125	.312.	2800	2900	.312. □.12. □ 312		
.137.	2800	2900	.137. □.12. □ 137	.325.	2800	2900	.325. □.12. □ 325		
.15.	2800/7700	2900/7750	.15. □.12. □ 150	.337.	2800	2900	.337. □.12. □ 337		
.162.	2800	2900	.162. □.12. □ 162	.350.	2800	2900	.350. □.12. □ 350		
.17.	2800/7700	2900/7750	.17. □.12. □ 168	.362.	2800	2900	.362. □.12. □ 362		
.18.	2800	2900	.18. □.12. □ 175	.375.	2800	2900	.375. □.12. □ 375		
.187.	2800	2900	.187. □.12. □ 187	.387.	2800	2900	.387. □.12. □ 387		
.20.	2800/7700	2900/7750	.20. □.12. □ 200	.400.	2800	2900	.400. □.12. □ 400		
.212.	2800	2900	.212. □.12. □ 212						

Please insert 1 for odd number of links or 2 for even number of links

Dimensions and order configurations

Part No. structure (pivoting)

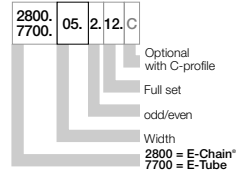

Part No. structure (locking)

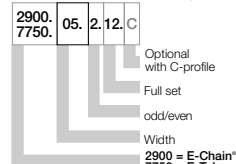

Note: The E4/00 System may end with either an inner side or an outer side link. Keep in mind that an outer side link always forms the first chain link at the moving end. The Part No. depends on an even or odd numbers of links. Please insert: 1 for odd number of links or 2 for even number of links

Full set, for both ends:
2900.05.2.12.C (even)

Single-part order:
2900.05.2.1.C (even)

Mounting bracket moving end

2900.05.2.1.C (even)

Mounting bracket fixed end



igus® Chainfix steel clamps and Chainfix stainless-steel clamps - max. pull forces, adjustable with hexagon socket. Available as single, double or triple clamps. **Details ► chapter 10**

Chainfix clamps for the C-profile

Part No. single clamps		Part No. double clamps		Part No. triple clamps		Cable
steel	stainless steel	steel	stainless steel	steel	stainless steel	ø [mm]
CFX12.1	CFX12.1.E	CFX12.2	CFX12.2.E	CFX12.3	-	06 - 12
CFX14.1	CFX14.1.E	CFX14.2	CFX14.2.E	CFX14.3	-	12 - 14
CFX16.1	CFX16.1.E	CFX16.2	CFX16.2.E	CFX16.3	-	14 - 16
CFX18.1	CFX18.1.E	CFX18.2	CFX18.2.E	CFX18.3	-	16 - 18
CFX20.1	CFX20.1.E	CFX20.2	CFX20.2.E	CFX20.3	-	18 - 20
CFX22.1	CFX22.1.E	CFX22.2	CFX22.2.E	CFX22.3	-	20 - 22
CFX26.1	CFX26.1.E	CFX26.2	CFX26.2.E	-	-	22 - 26
CFX30.1	CFX30.1.E	CFX30.2	CFX30.2.E	-	-	26 - 30
CFX34.1	CFX34.1.E	CFX34.2	CFX34.2.E	-	-	30 - 34
CFX38.1	CFX38.1.E	-	-	-	-	34 - 38
CFX42.1	CFX42.1.E	-	-	-	-	38 - 42



Chainfix Clip - Modular snap-on strain relief device for C-profile

Available for all igus® E-ChainSystems® with C-profiles and also suitable for assembly in the KMA mounting brackets and clip-on strain relief for crossbars. High pull forces, plug-in modular snap-on strain relief device. **Details ► chapter 10**

Cable ø [mm]	Part No. clamp	Part No. bottom part
04 - 08	CFC-08-M	CFC-08-C
08 - 12	CFC-12-M	CFC-12-C
12 - 16	CFC-16-M	CFC-16-C
16 - 20	CFC-20-M	CFC-20-C
20 - 24	CFC-24-M	CFC-24-C



Chainfix Nugget for the C-Profile

Strain relief for the fixation of cables up to a diameter of Ø 30 mm. Easy to assemble, without any screws and tools. Easy strain relief due to fixation with pre-harnessed cable strap, very small space requirement. **Details ► chapter 10**

Part No.	ø max. conduit [mm]	Width [mm]
CFN.20	20	10,8
CFN.30.52	30	16,8
CFN.20.N35	20	20,0

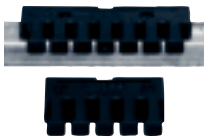

Chainfix tiwrap plates with clip-on connection for the C-profile

Can be plugged into the KMA C-profile. Easy to assemble without any screws. Easily solvable with screwdriver nevertheless safe stop. For all E-Chains® with KMA and integrated C-profile. **Details ► chapter 10**

Part No.	Width of strain relief [mm]	Number of teeth
3050.ZC	50	5
3075.ZC	75	7



Tiwrap plate as individual part

As individual component screwed on KMA. Can be plugged in the mounting brackets. **Details ► chapter 10**

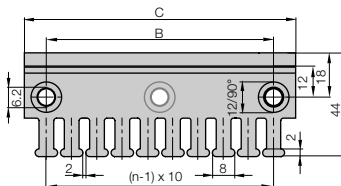
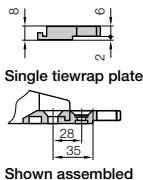

Tiwrap plate	No. of teeth n	Dim. C [mm]	Dim. B [mm]	Center bore
3050.ZB	5	50	30	-
3075.ZB	7	75	55	-
3100.ZB	10	100	80	-
3115.ZB	11	115	95	-
3125.ZB	12	125	105	-
3150.ZB	15	150	130	-
3175.ZB	17	175	155	-
3200.ZB	20	200	180	+
3225.ZB	22	225	205	+
3250.ZB	25	250	230	+

(- = no / + = yes)

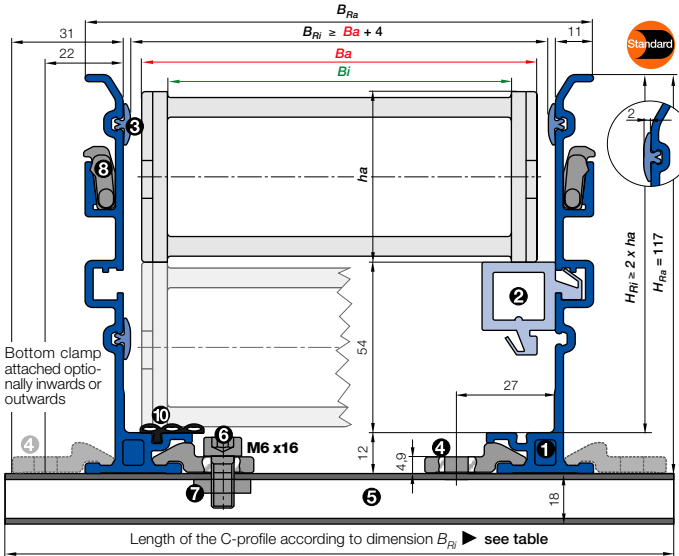

- B_a = Outer width E-Chains* / E-Tube
- B_i = Inner width E-Chains* / E-Tube
- h_a = Outer height E-Chains* / E-Tube
- H_{Ri} = Inner trough height
- H_{Ra} = Outer trough height
- B_{Ri} = Inner trough width ▶ depends on dim. B_a
- B_{Ra} = Outer trough width
- n_{Mon} = Number of installation sets (left/right)
- n_{Ri} = Number of trough sets (left/right)
- $H_{Ri} \geq 2 \cdot h_a$
- $B_{Ri} \geq B_a + 4$
- = Guide trough set ● = Glide bar
- = Installation set "Basic" ● = C-profile

Installation set "Basic" with C-profile

Bottom Clamp attached optionally inwards or outwards

280.05.200.0 ▶ Order example

B_{Ri} [mm]	Order example	
	Part No. attached inwards	Part No. attached outwards
.05	960.30.125	960.30.175
.06	960.30.150	960.30.200
.07	960.30.150	960.30.200
.08	960.30.175	960.30.225
.10	960.30.175	960.30.225
.11	960.30.200	960.30.250
.112	960.30.200	960.30.250
.12	960.30.200	960.30.250
.13	960.30.200	960.30.250
.137	960.30.225	960.30.275
.15	960.30.225	960.30.275
.162	960.30.250	960.30.300
.17	960.30.250	960.30.300
.18	960.30.250	960.30.300
.187	960.30.275	960.30.325
.20	960.30.275	960.30.325
.212	960.30.300	960.30.350
.23	960.30.300	960.30.350
.237	960.30.325	960.30.375
.25	960.30.325	960.30.375
.262	960.30.350	960.30.400
.28	960.30.350	960.30.400
.29	960.30.375	960.30.425
.30	960.30.375	960.30.425
.312	960.30.400	960.30.450
.325	960.30.400	960.30.450
.337	960.30.425	960.30.475
.350	960.30.425	960.30.475
.362	960.30.450	960.30.500
.375	960.30.450	960.30.500
.387	960.30.475	960.30.525
.400	960.30.475	960.30.525



- **Components, trough "Basic":** ① Trough side parts, aluminum, 2 m ② Glide bar, plastic, 2 m ③ Glide strips, plastic, 2 m (without glide strips on request) ⑩ Optional: Silencer profile, rubber
- **Components, installation set "Basic":** ④ Bottom clamp, aluminum ⑤ C-profile, steel galvanized ⑥ Screw M6 x 16 ⑦ Sliding nut M6 ⑧ Interface connector, plastic

Order example: Length of travel 30 m - Center mounted for Series 280.30.300.0 with $B_{Ri} = 327$

- Guide trough set (set of 2 trough side parts, incl. glide strips) **without** glide bar
Order text: 16 m guide trough without glide bar (8 x 2 m sections) Part No. 972.30.SL
- Guide trough set (set of 2 trough side parts, incl. glide strips) **with** glide bar
Order text: 16 m guide trough with glide bar (8 x 2 m sections) Part No. 972.31.SL
- Installation set "Basic" complete (guide trough-sets + 1)
Order text: 17 installation sets "Basic" Part No. 960.30.375
- Module for the fixed end
Order text: 1 set Part No. 972.80
- Option:** For an additional noise dampening with silencer profile, please add Index A - Example:
Part No. 972.30.SLA

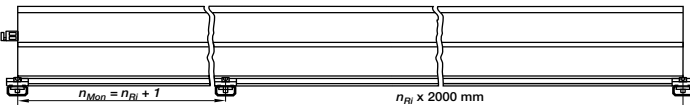

Principle sketch: Number of installation sets to be installed = Number of trough sections + 1



A quick fix for mounting the stationary end of an E-Chain*
With this module for the fixed end, fast and easy mounting onto the Aluminum "SuperTrough" is now possible without any drilling. Fast mounting of the E-Chain* by clamping onto the aluminum trough

- Quick relocation of the stationary end
- No drilling necessary ▶ page 9.16

Insert for the installation set "Heavy-Duty": **972.50.XXX** instead of (960.30.XXX) on the right column "attached outwards"

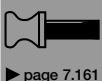

Price index



Low noise version E4/101
Series 381 available with
special rubber pads design



Cleanroom test
upon request



ESD classification:
Electrically conductive ESD/ATEX
version upon request



Opening E-Chains: Remove crossbars and
clips - Insert screwdriver into the slot, push
down, release by lever action



Remove lids/bottoms (E-Tubes) - Insert screw-
driver into the slot, release by lever action



When to use the Series 380/390/R780:

- If a low-noise version is required
- At very high speed and/or acceleration
- For long travels
- For high additional loads
- Also available without camber



When not to use it:

- If long side-mounted, unsupported
length is required
▶ Series E4.42, page 7.48
- If an extrem vibration-free E-Chain® is necessary
▶ Series E6.40, page 8.56
▶ Series R6.40, page 8.62

- ❶ Crossbars on E-Chain® removable
along both radii
- ❷ Stop dog with "brake" for noise reduction
- ❸ Closed and open styles can be combined
- ❹ Hinged snap-open removable lids
along outer radius of E-Tube
- ❺ Numerous interior separation possibilities
- ❻ Optimized glide pads
with lateral wear allowance
- ❼ Wide, rounded plastic crossbars - cable friendly
- ❽ Integrated strain relief possible
- ❾ KMA mounting brackets with
attachment points on all sides
- ❿ Locking or pivoting mounting brackets available
- ⓫ E-Chains® also available with
reverse bending radius "RBR"



Also available as
E4/00-NC without
camber: 380-NC

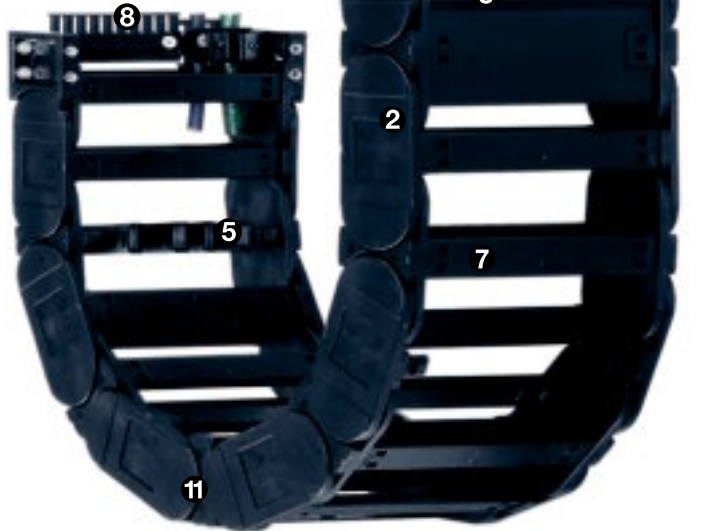

Order example complete E-Chain®

Please indicate chain-lengths or number of links Example: 5 m or 75 links

5 m 380.20.300.0

E-Chain®

with 2 separators 382 assembled every 2nd link

Interior separation

1 set 3800.20.1.12.C

Mounting bracket



Unsupported length

FL_G = with straight upper run

FL_B = with permitted sag

Further information ► **Design**, page 1.12

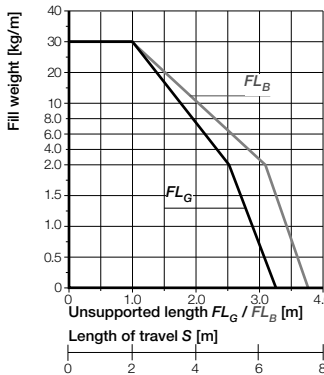
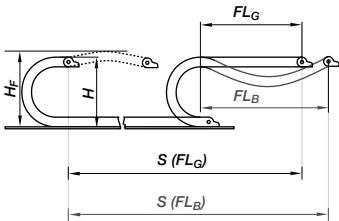

- S = Length of travel
- R = Bending radius
- H = Nominal clearance height
- H_F = Required clearance height
- H_{R1} = Trough inner height
- D = Overlength E-Chain" radius in final position
- $K = \pi \cdot R + \text{"safety"}$
- D_2 = Over length - long travels, gliding
- K_2 = "Further add-on
- H_2 = "Mounting height

*If the mounting bracket location is set lower

Other installation methods

- Vertical, hanging ≤ 100 m
- Vertical, standing ≤ 6 m
- Side mounted, unspupp. ≤ 2 m
- Rotary requires further calculation
- Unsupported length of upper run = upon request



Short travels - unsupported

Unsupported E-Chains" feature positive camber over short travels. This must be accounted for when specifying the clearance height H_F . Please consult igus" if space is particularly restricted.

The required clearance height:

$$H_F = H + 40 \text{ mm}$$

(with 2,0 kg/m fill weight)

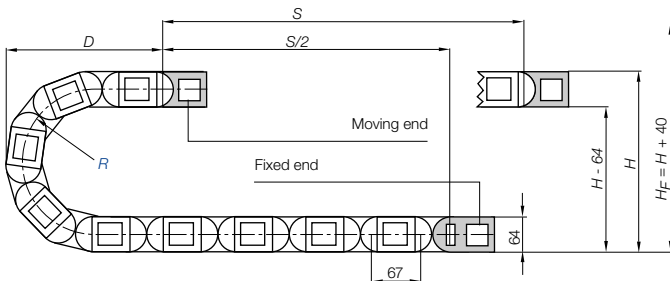

Pitch = 67 mm/link Links/m = 15 (1005 mm) Chain length = $S/2 + K$

R	075	100	115	125	150	170	200	215	250	300	350
H_{25}	215	265	295	315	365	405	465	495	565	665	765
D	174	199	214	224	249	269	299	314	349	399	449
K	370	450	500	530	610	670	765	810	920	1080	1235
H_2	215	265	295	186	186	186	186	186	186	186	186
D_{25}	174	199	214	475	570	620	780	865	1030	1150	1500
K_2	370	450	500	804	938	1072	1340	1407	1675	1943	2412

Long travel lengths from 10 m to max. 300 m Chain length = $S/2 + K_2$

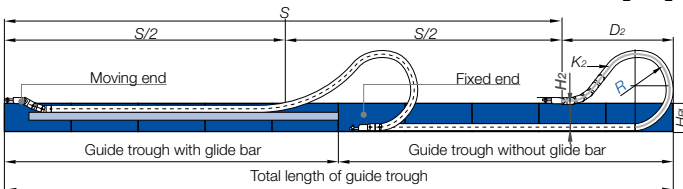

In case of travels between 4 and 10 m we recommend a longer unsupported length.



Gliding, long travel applications (max. 300 m)

In this case the E-Chain" upper run will be introduced in a guide trough on the lower run. We recommend to realize the engineering of such a plant by our technicians.

Speed / acceleration FL_G	max. 20 [m/s] / max. 200 [m/s]
Speed / acceleration FL_B	max. 3 [m/s] / max. 6 [m/s]
Gliding speed / acceleration (maximum)	max. 10 [m/s] / max. 50 [m/s]
Material - permitted temperature °C	igumid G / -40° up to +120° C
Flammability class, igumid G	VDE 0304 IIC UL94 HB

Technical Data



Details of material properties

► page 1.38

42

System E4/00
Inner height: 42 mm

Phone +49- (0) 22 03-96 49-800
Fax +49- (0) 22 03-96 49-222



► page 7.161

For support of the lower run - **Support Tray tool kit** available ► page 9.70

igus® E-ChainSystems®

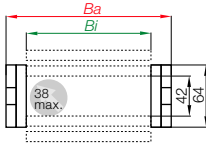

Part No. structure

380. 400. **300.** 0



Series 380 - E-Chain® with crossbars every link

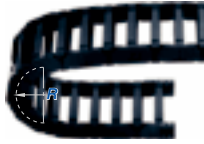

- Crossbars every link
- For rigid hydraulic hoses
- For applications particularly demanding
- Can be opened from two sides



Phone+49- (0) 22 03-96 49-800
Fax +49- (0) 22 03-96 49-222

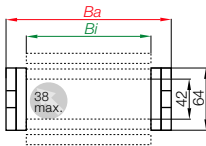

Part No. structure

390. 400. **300.** 0



Standard Series 390 - E-Chain® with crossbars every 2nd link



- Crossbars every 2nd link = Standard
- For nearly every situation
- Can be opened from two sides
- Easy assembly
- Stable
- Attractive price



igus® GmbH
51147 Cologne

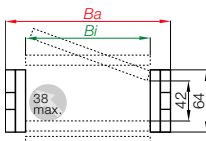

Part No. structure

780. 25. **300.** 0



Series R780 - Fully enclosed E-Tube



- Fully enclosed
- Excellent cable protection against dirt
- Protection against hot chips (up to 900°C)
- Lids along the entire inner radius are completely removable. Lids along the entire outer radius are single sided snap-open with a hinge on the other side to keep them attached to the chain or completely removable.



Internet: www.igus.eu
E-mail: info@igus.de

Low-noise! Special low-noise version with rubber pads

Series 381 - Order example: 381.15.250.0

Further information:

www.igus.de or phone +49-0 22 03-96 49-800



Part No.	Bi [mm]	Ba [mm]	380 [kg/m]	390 [kg/m]	R780 [kg/m]
380/390/780.05... □.0*	50	76	≈ 2,06	≈ 1,98	≈ 2,25
380/390.06... □.0	68	94	≈ 2,09	≈ 1,99	-
380/390/780.07... □.0	75	101	≈ 2,12	≈ 2,01	≈ 2,38
380/390.087... □.0	87	114	≈ 2,18	≈ 2,04	-
380/390/780.10... □.0	100	126	≈ 2,25	≈ 2,08	≈ 2,60
380/390/780.11... □.0	108	134	≈ 2,30	≈ 2,10	≈ 2,65
380/390.112... □.0	112	139	≈ 2,30	≈ 2,10	-
380/390/780.12... □.0	125	151	≈ 2,40	≈ 2,15	≈ 2,81
380/390.137... □.0	137	164	≈ 2,44	≈ 2,17	-
380/390/780.15... □.0	150	176	≈ 2,53	≈ 2,21	≈ 3,07
380/390.162... □.0	162	189	≈ 2,55	≈ 2,22	-
380/390/780.17... □.0	168	194	≈ 2,62	≈ 2,26	≈ 3,24
380/390.18... □.0	175	201	≈ 2,62	≈ 2,26	-
380/390.187... □.0	187	214	≈ 2,69	≈ 2,30	-
380/390/780.20... □.0	200	226	≈ 2,77	≈ 2,33	≈ 3,53
380/390.212... □.0	212	239	≈ 2,84	≈ 2,37	-
380/390.23... □.0	225	251	≈ 2,92	≈ 2,41	-
380/390.237... □.0	237	264	≈ 2,96	≈ 2,43	-
380/390/780.25... □.0	250	276	≈ 3,05	≈ 2,47	≈ 4,33
380/390.262... □.0	262	289	≈ 3,06	≈ 2,48	-
380/390.28... □.0	275	301	≈ 3,17	≈ 2,53	-
380/390.29... □.0	287	314	≈ 3,19	≈ 2,54	-
380/390/780.30... □.0	300	326	≈ 3,32	≈ 2,61	≈ 4,89
380/390.312... □.0	312	339	≈ 3,34	≈ 2,62	-
380/390.325... □.0	325	351	≈ 3,41	≈ 2,66	-
380/390.337... □.0	337	364	≈ 3,46	≈ 2,68	-
380/390.350... □.0	350	376	≈ 3,68	≈ 2,79	-
380/390.362... □.0	362	389	≈ 3,74	≈ 2,82	-
380/390.375... □.0	375	402	≈ 3,79	≈ 2,84	-
380/390.387... □.0	387	414	≈ 3,85	≈ 2,87	-
380/390.400... □.0	400	426	≈ 3,90	≈ 2,90	-

Hot Chips up to 850°C

E-Tubes that repel hot chips, up to 850°C. Some applications, depending on amount and size of the chips, can burn or melt the surface. That is no longer the case with the igus® "igumid HT" material. Order example: **Full E-Tube made of HT: 780.30.150.0.HT**
Lids made of HT: **780.30.HTE.150.0**
*for long travels. Upon request
Further Information: www.igus.de/en/HT
Delivery time up to 4 weeks!

System E4/00
Inner height: 42 mm

Phone +49- (0) 22 03-96 49-800
Fax +49- (0) 22 03-96 49-222

Available bending radii

R [mm] **075*** **100*** **115**** 125 150 170 200 215 250 300 350

Supplement Part No. with required radius. Example: 380.400.300.0

0 = standard color, other colors ▶ page 1.39 · Pitch = 67 mm/link - Links/m = 15

*Removable lid only, no hinged option · **not available for R780



Extender crossbar for large diameter hoses ▶ page 7.186

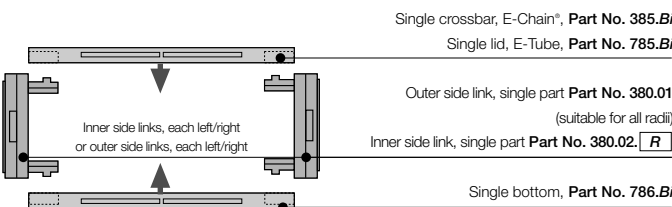

Part No. E-Chain® links, single parts

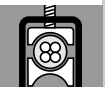
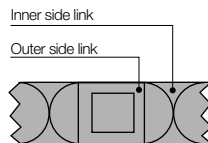

▶ page 7.161

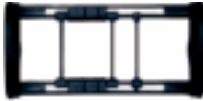

Vertical separators are used if a vertical subdivision is required. In the standard configuration, a separator is mounted at every second link. **Note:** Observe a lateral spacing of at least 25 mm (E-Tube)!

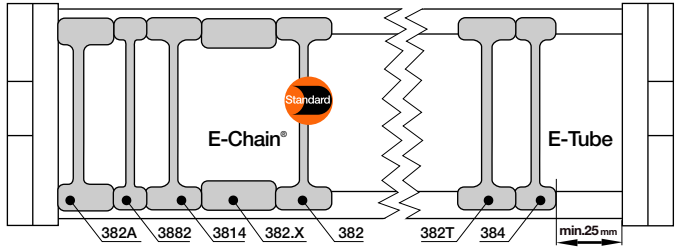

Vertical separator
381



Vertical separator
with a narrow base
3881



Vertical separator
381T



Spacer
381.XX



Locking separator
3804



Locking separator
383



Asymmetric
separator 381A

Vertical separator for E-Chains*	2,5
unassembled	381
assembled	382

Vertical separator* for E-Chains*	2,5
unassembled	3881
assembled	3882

Vertical separator for E-Tubes	3
unassembled	381T
assembled	382T

Spacer* for E-Chains*	14
unassembled	381.XX
assembled	382.XX

Locking separator for E-Chains*	2,5
unassembled	3804
assembled	3814

Locking separator for E-Tubes	2,5
unassembled	383
assembled	384

Asymmetric separator for E-Chains*	2,5
unassembled	381A
assembled	382A

*For side-mounted applications

Option 1: Vertical separators and spacers

● **Standard separator 381 for E-Chains®** offers safe stability due to its broad foot design, also when used with thick cables or hoses.

● **Vertical separator 3881 with a narrow foot (7 mm) for E-Chains®** with applications where a large number of small cables need to be individually separated.

● The **vertical separator 381T for E-Tubes** clamps to the fixed radius and remains free along the other radius to facilitate lid removal. If installing these yourself, please ensure that they are identically aligned.

● Separators (e.g. "side mounted") for E-Chains® can be fixed in their position with **spacers 381.XX**. The available inner height will be reduced by 2 mm, per spacer and side. To avoid this, the parts can be assembled on outside of the crossbar (not for long travels) **XX = width of the spacer** (available 10, 15 and 20)

Additionally:

● **Locking separator 3804 for E-Chains®** - with increased retention force for applications exposed to very high humidity or extreme loads. The extra retention force is achieved by asymmetric claws for the crossbar. Ensure proper alignment.

● **Locking separator 383 for E-Chains®** - with increased retention force for applications exposed to very high humidity or extreme loads. The extra retention force is achieved by asymmetric claws for the crossbar. Ensure proper alignment.

● **Asymmetric separator 381A for E-Chains®** (not for E-Tubes) with an 14-mm base, for combinations between spacers of different widths and vertical separators in side-mounted

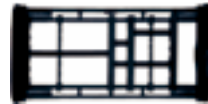
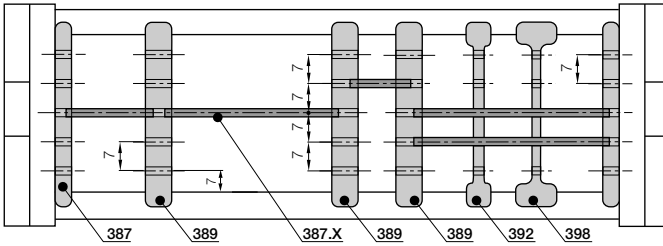

For use with many cables of differing diameters. E-Chains® and E-Tubes can be subdivided both vertically and horizontally. The shelves can be arranged elevator-shifted with different bottoms

Option 2: Shelves

● Side plates 386, middle plates 388 and shelves 386.X form the basic pattern of a shelf system. Shelves of various widths can be arranged at 5 different heights (in 7 mm increments).

● Slotted separators 391, are used for very fine subdivisions. However, they cannot be retrofitted into an existing separation system without dismantling the interior separators first.

● The unilateral open slotted separator 397 can be retrofitted into an existing interior separation system without a need for dismantling the interior separators. During an installation of open slotted separators, the top and bottom notches cannot be occupied by shelves.

Side plate for E-Chains®/E-Tubes	
unassembled	386
assembled	387

Middle plate for E-Chains®/E-Tubes	
unassembled	388
assembled	389

Slotted separator for E-Chains®/E-Tubes	
unassembled	391
assembled	392

Open slotted separator for E-Chains®/E-Tubes	
unassembled	397
assembled	398



Side plate
386



Middle plate
388

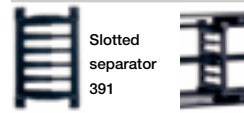

Slotted
separator
391

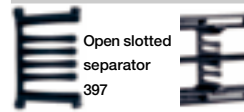

Open slotted
separator
397



Shelf 386.X

Shelf

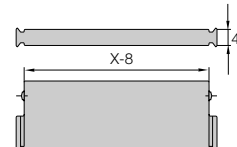

Width X [mm]	Part No. unassembled	Part No. assembled
018	386.18	387.18
023	386.23	387.23
025	386.25	387.25
028	386.28	387.28
033	386.33	387.33
043	386.43	387.43
050	386.50	387.50
054	386.54	387.54
062	386.62	387.62

Width X [mm]	Part No. unassembled	Part No. assembled
075	386.75	387.75
087	386.87	387.87
100	386.100	387.100
108	386.108	387.108
125	386.125	387.125
150	386.150	387.150
175	386.175	387.175
200	386.200	387.200
208	386.208	387.208

System E4/00
Inner height: 42 mm

Phone +49- (0) 22 03-96 49-800
Fax +49- (0) 22 03-96 49-222





Extension links - for extremely wide E-Chains® up to 3,0 m

- For applications in which particularly high fill weights necessitate extremely wide E-Chains® (up to 3000 mm)
- The extension link design allows virtually limitless side-by-side attachment of chains
- The unsupported length of a chain can be increased when additional loads are required
- Extension links can be used with E-Chains®, E-Tubes or as a combination of both
- They are suitable for unsupported and gliding applications in a guide trough
- E-Chains® with extension links are attached with KMA or steel mounting brackets



Part No. structure
380.10 / 20 / 10. 0
380.Bi1/Bi2/Bi3. 0

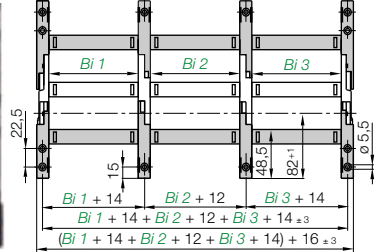
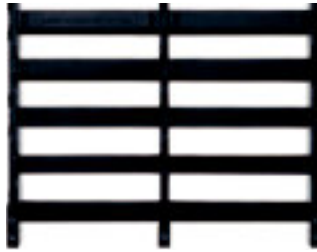

Extender crossbars - careful guide of hoses applications

- Suitable for hoses with a maximum outer diameter of 115 mm
- Gliding operation with crossbars assembled along the outer radius and a special guide trough
- Gliding operation not guaranteed with crossbars assembled along the inner radius
- The extender crossbar can either be attached to the side links directly or can be used in combination with two stranded snap-open crossbars

Consult igus® for your extender crossbar applications. We are happy to assist you with your design layout

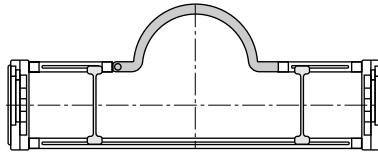

385.15RHD115 round extender crossbar combined with snap-open crossbars

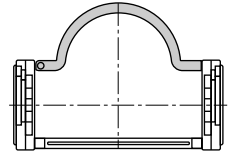

385.18RD115 round strap attached directly on the side link

Part No.	Max Ø [mm] hose	Form	Installation side link	Combination with snap-open crossb.
385.15.RHD115	115	○	-	+
385.18.RD115	115	○	+	-

○ = round + = yes / - = no



Hinged crossbars

- Typically E-Chain® crossbars are completely removable. In cases where the snap-open crossbars have to remain at the open link of the E-Chain®, a hinged design has been developed
- Length: 37,5 mm **Part No. 385.02** / snap-open crossbar (shortened): Bi-37,5 mm **Part No. 385.03**
- Please consult igus® for design assistance

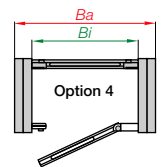
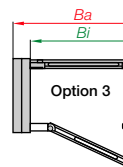
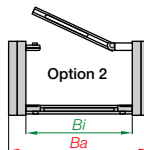
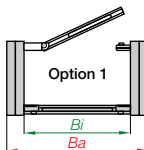
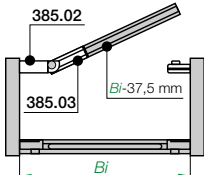

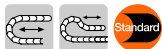

The Standard - Option KMA* - pivoting

- Recommended for unsupported and gliding applications
- Confined installation conditions
- Option - integrated C-profile strain relief device with Chainfix clip or strain relief tiwrap plates
- Corrosion resistant
- Universal mountable with attachment capability on all sides

*KMA = Polymer Metal Mounting Bracket

Moving end

3800/7800...□.2

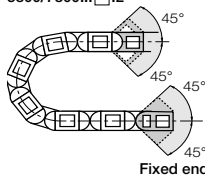

3800/7800...□.1



The attachment variants arising automatically by the choice of the KMA mounting bracket

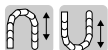
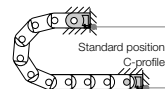

Option KMA - locking

- Recommended for vertical hanging / standing applications

Additionally:

- Universal mountable
- C-profile option
- Corrosion resistant
- Locked connections
- At very high acceleration

Moving end

3900/7900...□.2

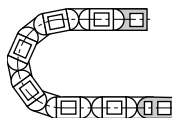

Fixed end

3900/7900...□.1



The attachment variants arising automatically by the choice of the KMA mounting bracket

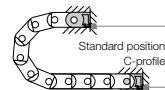

Fixed end

3800/7800...□.1 (pivoting)

3900/7900...□.1 (locking)

Moving end

(pivoting) 3800/7800...□.2

(locking) 3900/7900...□.2

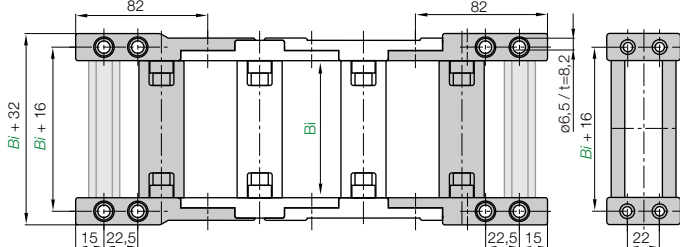

Width index	Part No. full set pivoting	locking	C-profile option [mm]	Bi	Width index	Part No. full set pivoting	locking	C-profile option [mm]	Bi
.05.	▶ 3800/7800	3900/7900	.05. □.12. □ 50		.23.	▶ 3800	3900	.23. □.12. □ 225	
.06.	▶ 3800	3900	.06. □.12. □ 68		.237.	▶ 3800	3900	.237. □.12. □ 237	
.07.	▶ 3800/7800	3900/7900	.07. □.12. □ 75		.25.	▶ 3800/7800	3900/7900	.25. □.12. □ 250	
.087.	▶ 3800	3900	.087. □.12. □ 87		.262.	▶ 3800	3900	.262. □.12. □ 262	
.10.	▶ 3800/7800	3900/7900	.10. □.12. □ 100		.28.	▶ 3800	3900	.28. □.12. □ 275	
.11.	▶ 3800/7800	3900/7900	.11. □.12. □ 108		.29.	▶ 3800	3900	.29. □.12. □ 287	
.112.	▶ 3800	3900	.112. □.12. □ 112		.30.	▶ 3800/7800	3900/7900	.30. □.12. □ 300	
.12.	▶ 3800/7800	3900/7900	.12. □.12. □ 125		.312.	▶ 3800	3900	.312. □.12. □ 312	
.137.	▶ 3800	3900	.137. □.12. □ 137		.325.	▶ 3800	3900	.325. □.12. □ 325	
.15.	▶ 3800/7800	3900/7900	.15. □.12. □ 150		.337.	▶ 3800	3900	.337. □.12. □ 337	
.162.	▶ 3800	3900	.162. □.12. □ 162		.350.	▶ 3800	3900	.350. □.12. □ 350	
.17.	▶ 3800/7800	3900/7900	.17. □.12. □ 168		.362.	▶ 3800	3900	.362. □.12. □ 362	
.18.	▶ 3800	3900	.18. □.12. □ 175		.375.	▶ 3800	3900	.375. □.12. □ 375	
.187.	▶ 3800	3900	.187. □.12. □ 187		.387.	▶ 3800	3900	.387. □.12. □ 387	
.20.	▶ 3800/7800	3900/7900	.20. □.12. □ 200		.400.	▶ 3800	3900	.400. □.12. □ 400	
.212.	▶ 3800	3900	.212. □.12. □ 212						

Please insert 1 for odd number of links or 2 for even number of links

Dimensions and order configurations

Part No. structure (pivoting)

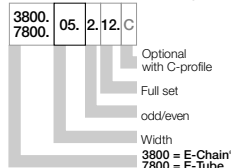

Part No. structure (locking)

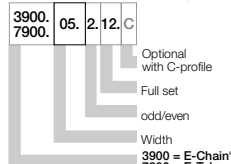

Note: The E4/00 System may end with either an inner side or an outer side link. Keep in mind that an outer side link always forms the first chain link at the moving end. The Part No. depends on an even or odd numbers of links. Please insert: 1 for odd number of links or 2 for even number of links

Full set, for both ends:
3800. 05. 2. 12. C (even)

Single-part order:
3800. 05. 2. 1. C (even)

Mounting bracket moving end

3800. 05. 2. 1. C (even)

Mounting bracket fixed end





igus® Chainfix steel clamps and Chainfix stainless-steel clamps - max. pull forces, adjustable with hexagon socket. Available as single, double or triple clamps. **Details ► chapter 10**

Chainfix clamps for C-profile

Part No. single clamps		Part No. double clamps		Part No. triple clamps		Cable
steel	stainless steel	steel	stainless steel	steel	stainless steel	ø [mm]
CFX12.1	CFX12.1.E	CFX12.2	CFX12.2.E	CFX12.3	-	06 - 12
CFX14.1	CFX14.1.E	CFX14.2	CFX14.2.E	CFX14.3	-	12 - 14
CFX16.1	CFX16.1.E	CFX16.2	CFX16.2.E	CFX16.3	-	14 - 16
CFX18.1	CFX18.1.E	CFX18.2	CFX18.2.E	CFX18.3	-	16 - 18
CFX20.1	CFX20.1.E	CFX20.2	CFX20.2.E	CFX20.3	-	18 - 20
CFX22.1	CFX22.1.E	CFX22.2	CFX22.2.E	CFX22.3	-	20 - 22
CFX26.1	CFX26.1.E	CFX26.2	CFX26.2.E	-	-	22 - 26
CFX30.1	CFX30.1.E	CFX30.2	CFX30.2.E	-	-	26 - 30
CFX34.1	CFX34.1.E	CFX34.2	CFX34.2.E	-	-	30 - 34
CFX38.1	CFX38.1.E	-	-	-	-	34 - 38
CFX42.1	CFX42.1.E	-	-	-	-	38 - 42



Chainfix Clip - Modular snap-on strain relief device for C-profile

Available for all igus® E-ChainSystems® with C-profiles and also suitable for assembly in the KMA mounting brackets and clip-on strain relief for crossbars. High pull forces, plug-in modular snap-on strain relief device. **Details ► chapter 10**

Cable ø [mm]	Part No. clamp	Part No. bottom part
04 - 08	CFC-08-M	CFC-08-C
08 - 12	CFC-12-M	CFC-12-C
12 - 16	CFC-16-M	CFC-16-C
16 - 20	CFC-20-M	CFC-20-C
20 - 24	CFC-24-M	CFC-24-C



Chainfix Nugget for the C-Profile

Strain relief for the fixation of cables up to a diameter of Ø 30 mm. Easy to assemble, without any screws and tools. Easy strain relief due to fixation with pre-harnessed cable strap, very small space requirement. **Details ► chapter 10**

Part No.	ø max. conduit [mm]	Width [mm]
CFN.20	20	10,8
CFN.30.52	30	16,8
CFN.20.N35	20	20,0

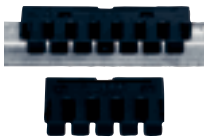

Chainfix tiwrap plates with clip-on connection for the C-profile

Can be plugged into the KMA C-profile. Easy to assemble without any screws. Easily solvable with screwdriver nevertheless safe stop. For all E-Chains® with KMA and integrated C-profile. **Details ► chapter 10**

Part No.	Width of strain relief [mm]	Number of teeth
3050.ZC	50	5
3075.ZC	75	7



Tiwrap plate as individual part

As individual component screwed on KMA. Can be plugged in the mounting brackets. **Details ► chapter 10**

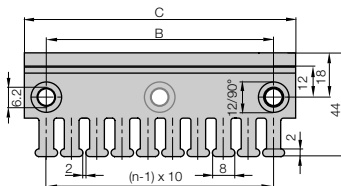
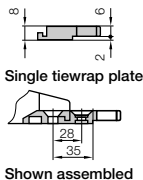

Tiwrap plate	No. of teeth n	Dim. C [mm]	Dim. B [mm]	Center bore
3050.ZB	5	50	30	-
3075.ZB	7	75	55	-
3100.ZB	10	100	80	-
3115.ZB	11	115	95	-
3125.ZB	12	125	105	-
3150.ZB	15	150	130	-
3175.ZB	17	175	155	-
3200.ZB	20	200	180	+
3225.ZB	22	225	205	+
3250.ZB	25	250	230	+

(- = no / + = yes)

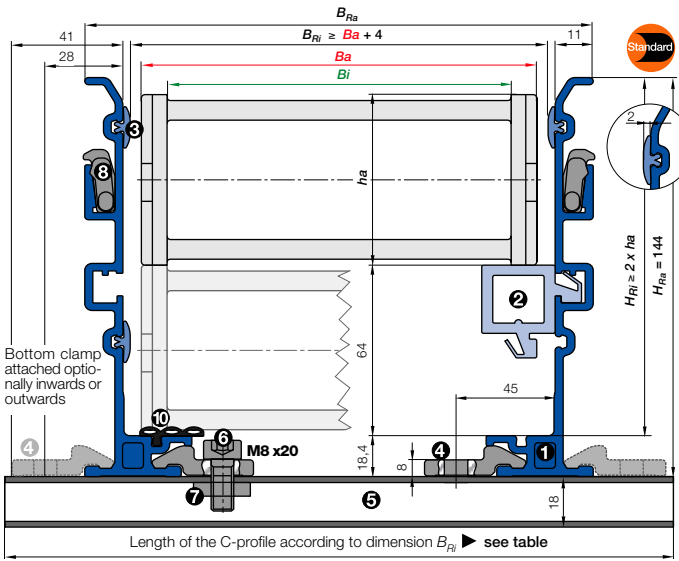

- Ba** = Outer width E-Chains* / E-Tube
- Bi** = Inner width E-Chains* / E-Tube
- ha** = Outer height E-Chains* / E-Tube
- H_{Ri}** = Inner trough height
- H_{Ra}** = Outer trough height
- B_{Ri}** = Inner trough width ▶ depends on dim. Ba
- B_{Ra}** = Outer trough width
- n_{Mon}** = Number of installation sets (left/right)
- n_{Ri}** = Number of trough sets (left/right)
- H_{Ri} ≥ 2 • ha**
- B_{Ri} ≥ Ba + 4**
- = Guide trough set ● = Glide bar
- = Installation set "Basic" ● = C-profile

Installation set "Basic" with C-profile

Bottom Clamp attached optionally inwards or outwards

380.05.300.0 ▶ Order example

B _{Ri} [mm]	Part No.	
	attached inwards	attached outwards
.05 80	-	960.40.200
.06 98	-	960.40.225
.07 105	-	960.40.225
.087 118	960.40.175	960.40.250
.10 130	960.40.200	960.40.250
.11 138	960.40.200	960.40.275
.112 143	960.40.200	960.40.275
.12 155	960.40.225	960.40.275
.137 168	960.40.225	960.40.300
.15 180	960.40.250	960.40.300
.162 193	960.40.250	960.40.325
.17 198	960.40.250	960.40.325
.18 205	960.40.275	960.40.325
.187 218	960.40.275	960.40.350
.20 230	960.40.300	960.40.350
.212 243	960.40.300	960.40.375
.23 255	960.40.325	960.40.375
.237 268	960.40.325	960.40.400
.25 280	960.40.350	960.40.400
.262 293	960.40.350	960.40.425
.28 305	960.40.375	960.40.425
.29 318	960.40.375	960.40.450
.30 330	960.40.400	960.40.450
.312 343	960.40.400	960.40.475
.325 355	960.40.425	960.40.475
.337 368	960.40.425	960.40.500
.350 380	960.40.450	960.40.500
.362 393	960.40.450	960.40.525
.375 406	960.40.475	960.40.525
.387 418	960.40.475	960.40.550
.400 430	960.40.500	960.40.550



- **Components, trough "Basic":** ① Trough side parts, aluminum, 2 m ② Glide bar, plastic, 2 m ③ Glide strips, plastic, 2 m (without glide strips on request) ⑩ Optional: Silencer profile, rubber
- **Components, installation set "Basic":** ④ Bottom clamp, aluminum ⑤ C-profile, steel galvanized ⑥ Screw M8 x 20 ⑦ Sliding nut M8 ⑧ Interface connector, plastic

Order example: Length of travel 30 m - Center mounted for Series 380.20.300.0 with B_{Ri} = 230

- Guide trough set (set of 2 trough side parts, incl. glide strips) **without** glide bar
Order text: 16 m guide trough without glide bar (8 x 2 m sections) Part No. 973.30.SL
- Guide trough set (set of 2 trough side parts, incl. glide strips) **with** glide bar
Order text: 16 m guide trough with glide bar (8 x 2 m sections) Part No. 973.31.SL
- Installation set "Basic" complete (guide trough-sets + 1)
Order text: 17 installation sets "Basic" Part No. 960.40.300
- Module for the fixed end
Order text: 1 set Part No. 973.81
- Option:** For an additional noise dampening with silencer profile, please add Index A - Example:
Part No. 973.30.SLA

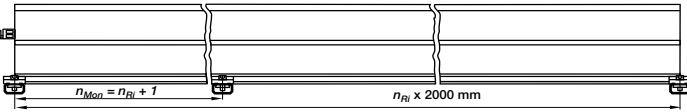

Prinzipzeichnung: Anzahl der zu montierenden Montagesets "Basic" = Anzahl der Rinnenstücke + 1

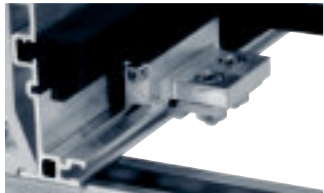

A quick fix for mounting the stationary end of an E-Chain*
 With this module for the fixed end, fast and easy mounting onto the Aluminum "SuperTrough" is now possible without any drilling. Fast mounting of the E-Chain* by clamping onto the aluminum trough
 ● Quick relocation of the stationary end ● No drilling necessary ▶ **page 9.16**

Insert for the installation set "Heavy-Duty": **973.50.XXX** instead of (960.40.XXX) on the right column "attached outwards"

Phone +49- (0) 22 03-96 49-800
 Fax +49- (0) 22 03-96 49-222

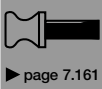

Price index



Low noise version E4/101
Series 401 available with
special rubber pads design



Cleanroom test
upon request



ESD classification:
Electrically conductive ESD/ATEX
version upon request



Opening E-Chains: Remove crossbars and clips - Insert screwdriver into the slot, push down, release by lever action



Remove lids/bottoms (E-Tubes) - Insert screwdriver into the slot, release by lever action



When to use the Series 400/410/R880:

- If a low-noise version is required
- At very high speeds and/or accelerations
- For long travels
- For high additional loads
- Also available without camber



When not to use it:

- If long side-mounted, unsupported length is required
▶ Series E4.56, page 7.62
- If an extrem vibration-free E-Chain[®] is necessary
▶ Series E6.52, page 8.66

- ❶ Crossbars on E-Chain[®] removable along both radii
- ❷ Closed and open styles can be combined
- ❸ Numerous interior separation possibilities
- ❹ Hinged snap-open removable lids along outer radius
- ❺ Stop dog with "brake" for noise reduction
- ❻ Wide, rounded plastic crossbars
- ❼ Optimized glide pads with lateral wear allowance
- ❽ KMA mounting brackets with attachment points on all sides
- ❾ Locking or pivoting mounting brackets available
- ❿ Integrated strain relief possible
- ⓫ Dirt-repellent exterior
- ⓬ E-Chains[®] also available with reverse bending radius "RBR"

Also available as
E4/00-NC without
camber: 400-NC



Order example complete E-Chain[®]

Please indicate chain-lengths or number of links Example: 3 m or 33 links

3 m 400.30.300.0

E-Chain[®]

with 2 separators 411 assembled every 2nd link

Interior separation

1 set 4000.30.1.12.C

Mounting bracket



Unsupported length

FL_G = with straight upper run

FL_B = with permitted sag

Further information ► **Design, page 1.12**

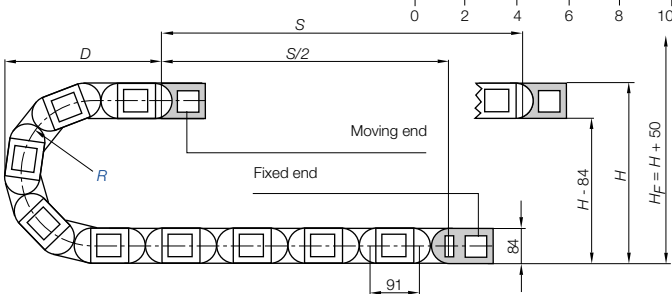
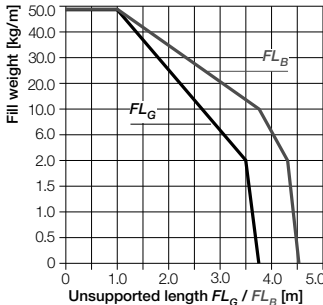
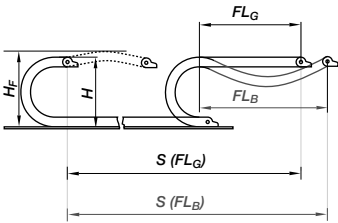

Pitch = 91 mm/link Links/m = 11 (1001 mm) Chain length = $S/2 + K$

R	135	150	175	200	240	250	300	350	400	500
H₂^{0/25}	360	385	435	485	565	585	685	785	885	1085
D	270	285	310	335	375	385	435	485	535	635
K	650	750	825	900	1020	1050	1225	1340	1450	1775
H₂	360	266	266	266	266	266	266	266	266	266
D₂⁺²⁵	270	480	600	730	950	920	1180	1440	1530	1900
K₂	650	819	1092	1274	1547	1547	2002	2275	2548	3276

- S** = Length of travel
 - R** = Bending radius
 - H** = Nominal clearance height
 - H_F** = Required clearance height
 - H_R** = Trough inner height
 - D** = Overlength E-Chain* radius in final position
 - K** = $\pi \cdot R$ + "safety"
 - D₂** = Over length - long travels, gliding
 - K₂** = *Further add-on
 - H₂** = *Mounting height
- *if the mounting bracket location is set lower

Other installation methods

- Vertical, hanging ≤ 100 m
- Vertical, standing ≤ 6 m
- Side mounted, un supp. $\leq 2,5$ m
- Rotary requires further calculation
- Unsupported length of upper run = upon request

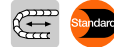

Short travels - unsupported

Unsupported E-Chains* feature positive camber over short travels. This must be accounted for when specifying the clearance height H_F . Please consult igus* if space is particularly restricted.

The required clearance height:
 $H_F = H + 50$ mm
(with 3,0 kg/m fill weight)

Long travel lengths from 10 m to max. 400 m Chain length = $S/2 + K_2$

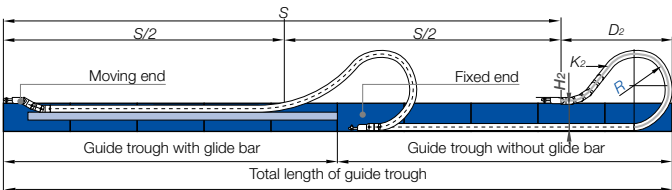

In case of travels between 4 and 10 m we recommend a longer unsupported length.



Gliding, long travel applications (max. 400 m)

In this case the E-Chain* upper run will be introduced in a guide trough on the lower run. We recommend to realize the engineering of such a plant by our technicians.

Speed / acceleration FL_G	max. 20 [m/s] / max. 200 [m/s ²]
Speed / acceleration FL_B	max. 3 [m/s] / max. 6 [m/s ²]
Gliding speed / acceleration (maximum)	max. 10 [m/s] / max. 50 [m/s ²]
Material - permitted temperature °C	igumid G / -40° up to +120° C
Flammability class, igumid G	VDE 0304 IIC UL94 HB

Technical Data



Details of material properties

► **page 1.38**

56
System E4/00
Inner height: 56 mm

Phone +49- (0) 22 03-96 49-800
Fax +49- (0) 22 03-96 49-222

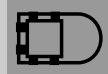

► **page 7.161**

For support of the lower run - Support Tray tool kit available ► page 9.70

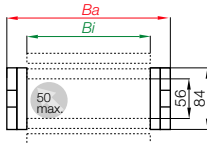

Part No. structure

400. 13. 250. 0



Series 400 - E-Chain® with crossbars every link

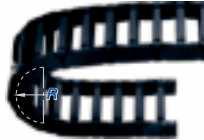

- Crossbars every link
- For rigid hydraulic hoses
- For applications particularly demanding
- Can be opened from two sides

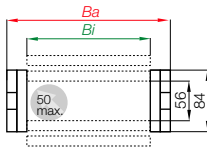

Part No. structure

410. 13. 250. 0



Series 410 - E-Chain® with crossbars every 2nd link

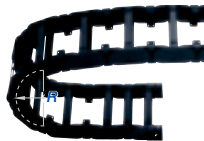

- Crossbars every 2nd link = Standard
- For nearly every situation
- Can be opened from two sides
- Easy assembly
- Stable
- Attractive price

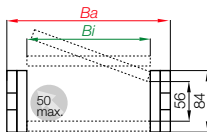

Part No. structure

880. 25. 250. 0



Series R880 - Fully enclosed E-Tube



- Fully enclosed
- Excellent cable protection against dirt
- Protection against hot chips (up to 900°C)
- Lids along the entire inner radius are completely removable. Lids along the entire outer radius are single sided snap-open with a hinge on the other side to keep them attached to the chain or completely removable.



Low-noise! Special low-noise version with rubber pads

Series 401 - Order example: 401.22.250.0

Further information:

www.igus.de or phone +49-0 22 03-96 49-800

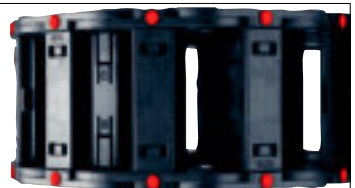

Part No.	Bi [mm]	Ba [mm]	400 [kg/m]	410 [kg/m]	R880 [kg/m]
400/410.05.....	50	84	≈ 3,44	≈ 3,12	-
400/410.06.....	65	99	≈ 3,50	≈ 3,20	-
400/410/880.07.....	75	109	≈ 3,53	≈ 3,44	≈ 3,98
400/410.08.....	87	121	≈ 3,56	≈ 3,48	-
400/410/880.10.....	100	134	≈ 3,71	≈ 3,53	≈ 4,27
400/410.11.....	112	147	≈ 3,84	≈ 3,60	-
400/410/880.12.....	125	159	≈ 3,91	≈ 3,63	≈ 4,63
400/410.13.....	137	172	≈ 4,04	≈ 3,70	-
400/410/880.15.....	150	184	≈ 4,10	≈ 3,73	≈ 5,06
400/410.16.....	162	197	≈ 4,21	≈ 3,78	-
400/410.17.....	175	209	≈ 4,32	≈ 3,84	-
400/410.18.....	187	222	≈ 4,43	≈ 3,89	-
400/410/880.20.....	200	234	≈ 4,46	≈ 3,91	≈ 5,63
400/410.21.....	212	247	≈ 4,57	≈ 3,96	-
400/410.22.....	225	259	≈ 4,63	≈ 3,99	-
400/410.23.....	237	272	≈ 4,76	≈ 4,06	-
400/410/880.25.....	250	284	≈ 4,85	≈ 4,10	≈ 6,36
400/410.26.....	262	297	≈ 4,94	≈ 4,15	-
400/410/880.27.....	275	309	≈ 5,05	≈ 4,20	≈ 6,72
400/410.28.....	287	322	≈ 5,07	≈ 4,21	-
400/410/880.30.....	300	334	≈ 5,29	≈ 4,32	≈ 7,02
400/410.31.....	312	347	≈ 5,29	≈ 4,32	-
400/410.32.....	325	359	≈ 5,38	≈ 4,37	-
400/410.33.....	337	372	≈ 5,56	≈ 4,46	-
400/410/880.35.....	350	384	≈ 5,71	≈ 4,53	≈ 7,72
400/410.36.....	362	397	≈ 5,71	≈ 4,53	-
400/410.37.....	375	409	≈ 5,73	≈ 4,54	-
400/410.38.....	387	422	≈ 5,82	≈ 4,59	-
400/410/880.40.....	400	434	≈ 6,02	≈ 4,69	≈ 8,72
400/410.41.....	412	447	≈ 6,17	≈ 4,76	-
400/410.42.....	425	459	≈ 6,33	≈ 4,84	-
400/410.43.....	437	472	≈ 6,39	≈ 4,87	-
400/410.45.....	450	484	≈ 6,46	≈ 4,91	-
400/410/880.46.....	462	497	≈ 6,48	≈ 4,92	≈ 9,19
400/410.47.....	475	509	≈ 6,61	≈ 4,98	-
400/410.48.....	487	522	≈ 6,65	≈ 5,01	-
400/410.50.....	500	534	≈ 6,74	≈ 5,05	-
400/410.51.....	512	547	≈ 6,77	≈ 5,06	-
400/410.52.....	525	559	≈ 6,81	≈ 5,08	-
400/410.53.....	537	572	≈ 6,96	≈ 5,16	-
400/410.55.....	550	584	≈ 7,45	≈ 5,40	-
400/410.60.....	600	634	≈ 7,65	≈ 5,50	-

Hot Chips up to 850°C

E-Tubes that repel hot chips, up to 850°C. Some applications, depending on amount and size of the chips, can burn or melt the surface. That is no longer the case with the igus® "igumid HT" material. Order example: Full E-Tube made of HT: **880.40.150.0.HT**
Lids made of HT: **880.40.HTE.150.0**
*for long travels upon request
Further Information: www.igus.de/en/HT
Delivery time up to 4 weeks!

System E4/00
Inner height: 56 mm

Phone +49- (0) 22 03-96 49-800
Fax +49- (0) 22 03-96 49-222

Available bending radii

R [mm] 135** 150 175 200 240 250 300 350 400 500

Supplement Part No. with required radius. Example: 400.30.300.0

0 = standard color, other colors ▶ page 1.39 · Pitch = 91 mm/link · Links/m = 11

Single crossbar, E-Chain®, Part No. 450.Bi

Single lid, E-Tube, Part No. 885.Bi

Outer side link, single part Part No. 400.01

(suitable for all radii)

Inner side link, single part Part No. 400.02. R

Single bottom, E-Tube, Part No. 886.Bi

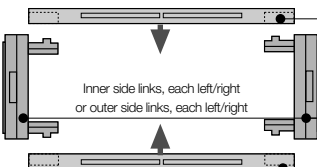

* Removable lid only, no hinged option

** not available for R880



Extender crossbar for large diameter hoses ▶ page 7.196

Part No. E-Chain® links, single parts

Inner side link

Outer side link

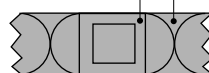

▶ page 7.161



Vertical separators are used if a vertical subdivision is required. In the standard configuration, a separator is mounted at every second link. **Note:** Observe a lateral spacing of at least 32 mm (E-Tube) and 16 mm (E-Chain)!

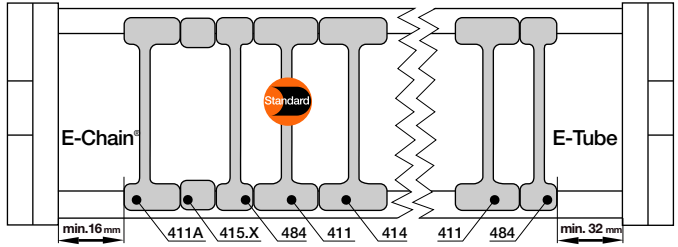

Vertical separator
401



Vertical separator
483



Spacer
405.XX



Locking separator
404



Vertical separator
406



Asymmetric
separator 401A



Vertical separator for E-Chains®/E-Tubes	
unassembled	401
assembled	411



Vertical separator for E-Chains®/E-Tubes	
unassembled	483
assembled	484



Spacer® for E-Chains®	
unassembled	405.XX
assembled	415.XX



Locking separator for E-Chains®	
unassembled	404
assembled	414



Vertical separator for E-Tubes	
unassembled	406
assembled	416



Asymmetric separator for E-Chains®	
unassembled	401A
assembled	411A



*For side-mounted applications

Option 1: Vertical separators and spacers

● **Standard separator 401** for E-Chains®/E-Tubes offers safe stability due to its broad foot design, also when used with thick cables or hoses.

● **Vertical separator 483** with a narrow foot for E-Chains® and E-Tubes with applications where a large number of small cables need to be individually separated.

● Separators (e.g. "side mounted") for E-Chains® can be fixed in their position with **Spacers 405.XX**. The available inner height will be reduced by 2 mm, per spacer and side. To avoid this, the parts can be assembled on outside of the crossbar (not for long travels)
XX = width of the spacer (available 10, 15, 20, 30 and 40 mm)

Additionally:

● **Locking separator for E-Chains® 404** - with increased retention force for applications exposed to very high humidity or extreme loads. The extra retention force is achieved by asymmetric claws for the crossbar. Ensure proper alignment

● **Locking separator 406** for E4-Tubes - safe fitting locked on lid or bottom of the Tube and sideways slideable. The opposing lid or bottom can easily be opened and closed. Especially capable if many separators need to be assembled on a tight inner width

● **Asymmetric separator 401A** for E-Chains® with an 18-mm base, for combinations between spacers of different widths and vertical separators in side-mounted applications, for instance.

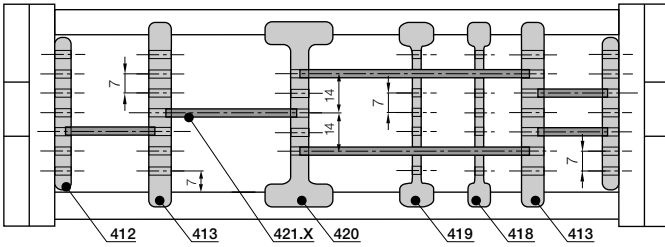

For use with many cables of differing diameters. E-Chains[®] and E-Tubes can be subdivided both vertically and horizontally. The shelves can be arranged elevator-shifted with different bottoms

Option 2: Shelves

● Side plates 402, middle plates 403 and shelves 420.X form the basic pattern of a shelf system. Shelves of various widths can be arranged at 7 different heights (in 7 mm increments).

● Locking vertical separator 410, slotted combined with shelves (only for E-Chains[®]).

● Slotted separators 408, are used for very fine subdivisions. However, they cannot be retrofitted into an existing separation system without dismantling the interior separators first.

● The unilateral open slotted separator 409 can be retrofitted into an existing interior separation system without a need for dismantling the interior separators. During an installation of open slotted separators, the top and bottom notches cannot be occupied by shelves.

Side plate for E-Chains [®] /E-Tubes	
unassembled	402
assembled	412

Middle plate for E-Chains [®] /E-Tubes	
unassembled	403
assembled	413

Locking vertical separator for E-Chains [®]	
unassembled	410
assembled	420

Slotted separator for E-Chains [®] /E-Tubes	
unassembled	408
assembled	418

Open slotted separator for E-Chains [®] /E-Tubes	
unassembled	409
assembled	419

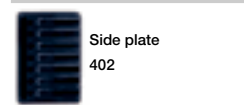

Side plate 402

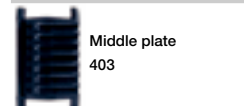

Middle plate 403

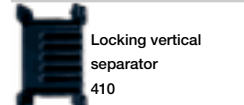

Locking vertical separator 410



Slotted separator 408

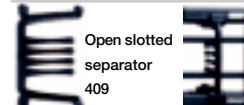

Open slotted separator 409



Shelf 420.X

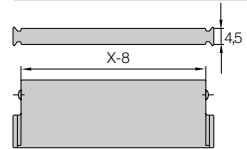

Width X [mm]	Part No. unassembled	Part No. assembled
018	420.18	421.18
023	420.23	421.23
025	420.25	421.25
028	420.28	421.28
033	420.33	421.33
043	420.43	421.43
050	420.50	421.50
062	420.62	421.62

Width X [mm]	Part No. unassembled	Part No. assembled
075	420.75	421.75
088	420.88	421.88
100	420.100	421.100
125	420.125	421.125
150	420.150	421.150
175	420.175	421.175
187	420.187	421.187
200	420.200	421.200

Additional elements for interior separation

Center crossbar	
unassembled	405
assembled	415

Center crossbar - was developed for applications with a large number of thin cables. The center crossbar offers the option of subdividing the E-Chain[®] independently into upper and lower halves.

Rollclip	
unassembled	489.27
assembled	490.27

Rollclip - minimizes abrasion of particularly sensitive hoses. The Rollclip is simply clamped onto the opening crossbar. The movable rollers compensate for relative movement between the chain and hose.

Roller separator	
unassembled	429
assembled	430

Roller separator - performs a similar function to the Rollclip, but doubles as a separator.

System E4/00
Inner height: 56 mm

Phone +49- (0) 22 03-96 49-800
Fax +49- (0) 22 03-96 49-222

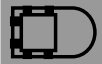



Extension links - for extremely wide E-Chains® up to 3,0 m

- For applications in which particularly high fill weights necessitate extremely wide E-Chains® (up to 3000 mm)
- The extension link design allows virtually limitless side-by-side attachment of chains
- The unsupported length of a chain can be increased when additional loads are required
- Extension links can be used with E-Chains®, E-Tubes or as a combination of both
- They are suitable for unsupported and gliding applications in a guide trough
- E-Chains® with extension links are attached with KMA or steel mounting brackets

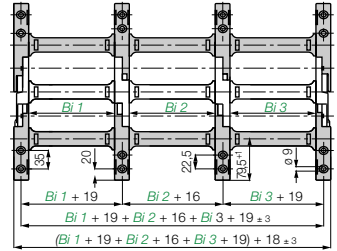

Part No. structure
400.10 /20 /10. 0
400.Bi1/Bi2/Bi3. 0



Extender crossbars - careful guide of hoses applications

- Suitable for hoses with a maximum outer diameter of 245 mm
- Gliding operation with crossbars assembled along the outer radius and a special guide trough
- Gliding operation not guaranteed with crossbars assembled along the inner radius
- The extender crossbar can either be attached to the side links directly or can be used in combination with two stranded snap-open crossbars

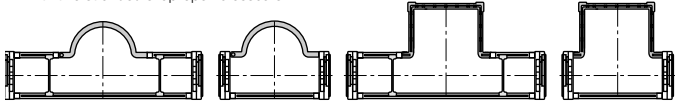

Round extender crossbar with snap-open crossbars Attached directly to the side link Square extender crossbar with snap-open crossbars Attached directly to the side link

Consult igus® for your extender crossbar applications. We are happy to assist you with your design layout

Part No.	Max Ø [mm] hose	Form	Installation side link	Combination with snap-open crossb.
450.15.RHD115	115	○	-	+
450.17.RD115	115	○	+	-
450.25.D150	150	□	+	-
450.30.D200	180	□	+	-
450.35.D250	195	□	+	-
450.40.D300	245	□	+	-
450.20.HD150	150	□	-	+
450.25.HD200	180	□	-	+
450.30.HD250	195	□	-	+

○ = round □ = square + = yes / - = no



E4 clip-on cable binder

- For side-mounted applications
- Serves as a clip-on, lateral guide for hoses and cables on E-Chains®
- The loops can be adjusted as required
- Compatible with many E4 E-Chains®
- Stylish and economical
- One clip and one locking band are needed for each chain link
- Call us if you have any questions on project planning

Part No.	Form
450.B12	Locking clip, comprising a locking element
450.B12.200	Locking band, comprising a locking element and band; 12 x 1,5 x 200 mm

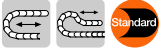

The Standard - Option KMA* - pivoting

- Recommended for unsupported and gliding applications
- Confined installation conditions
- Option - integrated C-profile strain relief device with Chainfix clip or strain relief tiwrap plates
- Corrosion resistant
- Universal mountable with attachment capability on all sides

*KMA = Polymer Metal Mounting Bracket

Moving end
4000/8800... [] .2

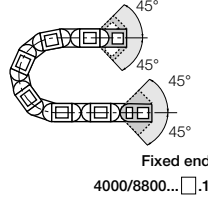

The attachment variants arising automatically by the choice of the KMA mounting bracket

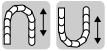
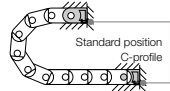

Option KMA - locking

- Recommended for vertical hanging / standing applications
- Additionally:**
- Universal mountable
 - C-profile option
 - Corrosion resistant
 - Locked connections
 - At very high acceleration

Moving end
4100/8900... [] .2

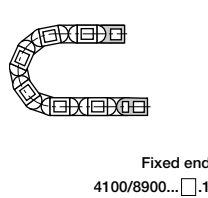

The attachment variants arising automatically by the choice of the KMA mounting bracket

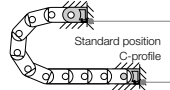

Fixed end
4000/8800... [] .1 (pivoting)
4100/8900... [] .1 (locking)

Moving end
(pivoting) 4000/8800... [] .2
(locking) 4100/8900... [] .2

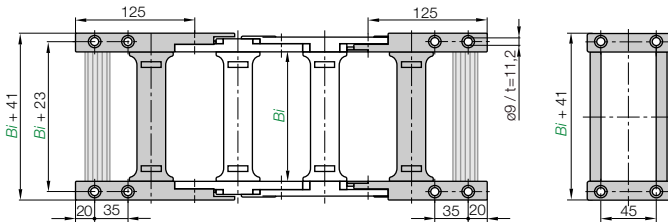

Width index	Part No. full set		C-profile option [mm]	Bi	Width index	Part No. full set		C-profile option [mm]	Bi
	pivoting	locking				pivoting	locking		
.05.	4000	4100	.05. [] .12 []	50	.32.	4000	4100	.32. [] .12 []	325
.06.	4000	4100	.06. [] .12 []	65	.33.	4000	4100	.33. [] .12 []	337
.07.	4000/8800	4100/8900.07. [] .12 []	75		.35.	4000/8800	4100/8900.35. [] .12 []	350	
.10.	4000/8800	4100/8900.10. [] .12 []	100		.36.	4000	4100	.36. [] .12 []	362
.11.	4000	4100	.11. [] .12 []	112	.37.	4000	4100	.37. [] .12 []	375
.12.	4000/8800	4100/8900.12. [] .12 []	125		.38.	4000	4100	.38. [] .12 []	387
.13.	4000	4100	.13. [] .12 []	137	.40.	4000/8800	4100/8900.40. [] .12 []	400	
.15.	4000/8800	4100/8900.15. [] .12 []	150		.41.	4000	4100	.41. [] .12 []	412
.16.	4000	4100	.16. [] .12 []	162	.42.	4000	4100	.42. [] .12 []	425
.17.	4000	4100	.17. [] .12 []	175	.43.	4000	4100	.43. [] .12 []	437
.18.	4000	4100	.18. [] .12 []	187	.45.	4000	4100	.45. [] .12 []	450
.20.	4000/8800	4100/8900.20. [] .12 []	200		.46.	4000/8800	4100/8900.46. [] .12 []	462	
.21.	4000	4100	.21. [] .12 []	212	.47.	4000	4100	.47. [] .12 []	475
.22.	4000	4100	.22. [] .12 []	225	.48.	4000	4100	.48. [] .12 []	487
.23.	4000	4100	.23. [] .12 []	237	.50.	4000	4100	.50. [] .12 []	500
.25.	4000/8800	4100/8900.25. [] .12 []	250		.51.	4000	4100	.51. [] .12 []	512
.26.	4000	4100	.26. [] .12 []	262	.52.	4000	4100	.52. [] .12 []	525
.27.	4000/8800	4100/8900.27. [] .12 []	275		.53.	4000	4100	.53. [] .12 []	537
.28.	4000	4100	.28. [] .12 []	287	.55.	4000	4100	.55. [] .12 []	550
.30.	4000/8800	4100/8900.30. [] .12 []	300		.60.	4000	4100	.60. [] .12 []	600
.31.	4000	4100	.31. [] .12 []	312					

Please insert [1] for odd number of links or [2] for even number of links

Dimensions and order configurations

Part No. structure (pivoting)

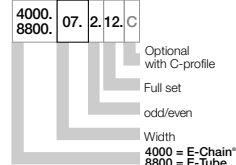

Part No. structure (locking)

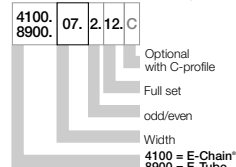

Note: The E4/00 System may end with either an inner side or an outer side link. Keep in mind that an outer side link always forms the first chain link at the moving end. The Part No. depends on an even or odd numbers of links. Please insert: [1] for odd number of links or [2] for even number of links

Full set, for both ends:

[4000.05.2.12.C] (even)

Single-part order:

[4000.05.2.12.C] (even)

Mounting bracket moving end

[4000.05.2.1.C] (even)

Mounting bracket fixed end





igus® Chainfix steel clamps and Chainfix stainless-steel clamps - max. pull forces, adjustable with hexagon socket. Available as single, double or triple clamps. **Details ► chapter 10**

Chainfix clamps for the C-profile

Part No. single clamps		Part No. double clamps		Part No. triple clamps		Cable
steel	stainless steel	steel	stainless steel	steel	stainless steel	ø [mm]
CFX12.1	CFX12.1.E	CFX12.2	CFX12.2.E	CFX12.3	-	06 - 12
CFX14.1	CFX14.1.E	CFX14.2	CFX14.2.E	CFX14.3	-	12 - 14
CFX16.1	CFX16.1.E	CFX16.2	CFX16.2.E	CFX16.3	-	14 - 16
CFX18.1	CFX18.1.E	CFX18.2	CFX18.2.E	CFX18.3	-	16 - 18
CFX20.1	CFX20.1.E	CFX20.2	CFX20.2.E	CFX20.3	-	18 - 20
CFX22.1	CFX22.1.E	CFX22.2	CFX22.2.E	CFX22.3	-	20 - 22
CFX26.1	CFX26.1.E	CFX26.2	CFX26.2.E	-	-	22 - 26
CFX30.1	CFX30.1.E	CFX30.2	CFX30.2.E	-	-	26 - 30
CFX34.1	CFX34.1.E	CFX34.2	CFX34.2.E	-	-	30 - 34
CFX38.1	CFX38.1.E	-	-	-	-	34 - 38
CFX42.1	CFX42.1.E	-	-	-	-	38 - 42



Chainfix Clip - Modular snap-on strain relief device for C-profile

Available for all igus® E-ChainSystems® with C-profiles and also suitable for assembly in the KMA mounting brackets and clip-on strain relief for crossbars. High pull forces, plug-in modular snap-on strain relief device. **Details ► chapter 10**

Cable ø [mm]	Part No. clamp	Part No. bottom part
04 - 08	CFC-08-M	CFC-08-C
08 - 12	CFC-12-M	CFC-12-C
12 - 16	CFC-16-M	CFC-16-C
16 - 20	CFC-20-M	CFC-20-C
20 - 24	CFC-24-M	CFC-24-C



Chainfix Nugget for the C-Profile

Strain relief for the fixation of cables up to a diameter of Ø 30 mm. Easy to assemble, without any screws and tools. Easy strain relief due to fixation with pre-harnessed cable strap, very small space requirement. **Details ► chapter 10**

Part No.	ø max. conduit [mm]	Width [mm]
CFN.20	20	10,8
CFN.30.52	30	16,8
CFN.20.N35	20	20,0

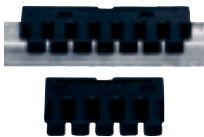

Chainfix tiwrap plates with clip-on connection for the C-profile

Can be plugged into the KMA C-profile. Easy to assemble without any screws. Easily solvable with screwdriver nevertheless safe stop. For all E-Chains® with KMA and integrated C-profile. **Details ► chapter 10**

Part No.	Width of strain relief [mm]	Number of teeth
3050.ZC	50	5
3075.ZC	75	7



Tiwrap plate as individual part

As individual component screwed on KMA. Can be plugged in the mounting brackets. **Details ► chapter 10**

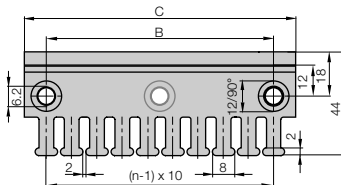
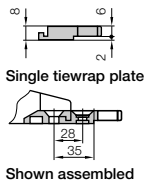

Tiwrap plate	No. of teeth	Dim. C [mm]	Dim. B [mm]	Center bore
3050.ZB	5	50	30	-
3075.ZB	7	75	55	-
3100.ZB	10	100	80	-
3115.ZB	11	115	95	-
3125.ZB	12	125	105	-
3150.ZB	15	150	130	-
3175.ZB	17	175	155	-
3200.ZB	20	200	180	+
3225.ZB	22	225	205	+
3250.ZB	25	250	230	+

(- = no / + = yes)

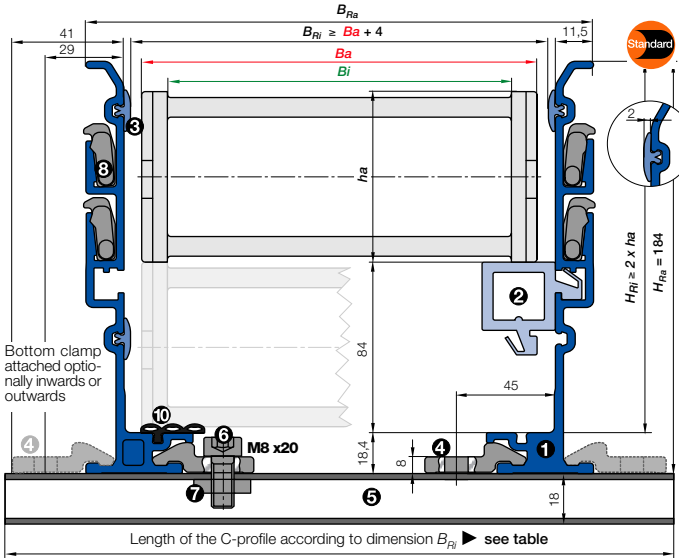

- B_a** = Outer width E-Chains* / E-Tube
- B_i** = Inner width E-Chains* / E-Tube
- h_a** = Outer height E-Chains* / E-Tube
- H_{ri}** = Inner trough height
- H_{Ra}** = Outer trough height
- B_{Ri}** = Inner trough width ▶ depends on dim. B_a
- B_{Ra}** = Outer trough width
- n_{Mon}** = Number of installation sets (left/right)
- n_{Ri}** = Number of trough sets (left/right)
- H_{Ri} ≥ 2 • h_a**
- B_{Ri} ≥ B_a + 4**
- = Guide trough set ● = Glide bar
- = Installation set "Basic" ● = C-profile

Installation set "Basic" with C-profile

Bottom Clamp attached optionally inwards or outwards

400.05.200.0 ▶ Order example

B _{Ri} [mm]	Part No.	
	attached inwards	attached outwards
.05	88	-
.06	103	-
.07	113	-
.08	125	960.50.175
.10	138	960.50.200
.11	151	960.50.225
.12	163	960.50.225
.13	176	960.50.225
.15	188	960.50.250
.16	201	960.50.250
.17	213	960.50.275
.18	226	960.50.275
.20	238	960.50.300
.21	251	960.50.300
.22	263	960.50.325
.23	276	960.50.325
.25	288	960.50.350
.26	301	960.50.350
.27	313	960.50.375
.28	326	960.50.375
.30	338	960.50.400
.31	351	960.50.400
.32	363	960.50.425
.33	376	960.50.425
.35	388	960.50.450
.36	401	960.50.450
.37	413	960.50.475
.38	426	960.50.475
.40	438	960.50.500
.41	451	960.50.500
.42	463	960.50.525
.43	476	960.50.525
.45	488	960.50.550
.46	501	960.50.550
.47	513	960.50.575
.48	526	960.50.575
.50	538	960.50.600
.51	551	960.50.600
.52	563	960.50.625
.53	576	960.50.625
.55	588	960.50.650
.60	638	960.50.700



- **Components, trough "Basic":** ① Trough side parts, aluminum, 2 m ② Glide bar, plastic, 2 m ③ Glide strips, plastic, 2 m (without glide strips on request) ⑩ Optional: Silencer profile, rubber
- **Components, installation set "Basic":** ④ Bottom clamp, aluminum ⑤ C-profile, steel galvanized ⑥ Screw M8 x 20 ⑦ Sliding nut M8 ⑧ Interface connector, plastic

Order example: Length of travel 30 m - Center mounted for Series 400.10.200.0 with B_{Ri} = 138

- Guide trough set (set of 2 trough side parts, incl. glide strips) **without** glide bar
Order text: 16 m guide trough without glide bar (8 x 2 m sections) **Part No. 974.30.SL**
- Guide trough set (set of 2 trough side parts, incl. glide strips) **with** glide bar
Order text: 16 m guide trough with glide bar (8 x 2 m sections) **Part No. 974.31.SL**
- Installation set "Basic" complete (guide trough-sets + 1)
Order text: 17 installation sets "Basic" **Part No. 960.50.200**
- Module for the fixed end
Order text: 1 set **Part No. 974.80**
- Option:** For an additional noise dampening with silencer profile, please add Index A - Example: **Part No. 974.30.SLA**

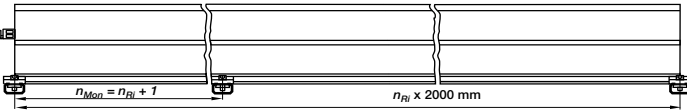

Principle sketch: Number of installation sets to be installed = Number of trough sections + 1

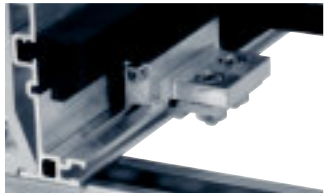

A quick fix for mounting the stationary end of an E-Chain®
 With this module for the fixed end, fast and easy mounting onto the Aluminum "SuperTrough" is now possible without any drilling. Fast mounting of the E-Chain® by clamping onto the aluminum trough
 ● Quick relocation of the stationary end ● No drilling necessary ▶ [page 9.16](#)

Insert for the installation set "Heavy-Duty": **974.50.XXX** instead of (960.50.XXX) on the right column "attached outwards"

Phone +49- (0) 22 03-96 49-800
 Fax +49- (0) 22 03-96 49-222

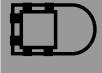

▶ [chapter 10](#)



▶ [chapter 9](#)



▶ [page 7.161](#)

Price Index



This E4 Series is a
"Low-noise-Version"



Cleanroom test
upon request



ESD classification:
Electrically conductive ESD/ATEX
version upon request



Opening E-Chains: Remove crossbars and clips - Insert screwdriver into the slot, push down, release by lever action



Remove lids/bottoms (E-Tubes) - Insert screwdriver into the slot, release by lever action



When to use the Series 600/601/R608:

- If a low-noise version is required
- At very high speeds and/or accelerations
- For long travels
- For high additional loads



When not to use it:

- If a simple and low-cost solution is required
▶ Series 1640, page 7.90
- If an increased inner height is required
▶ Series 640, page 7.208

- ❶ Crossbars on E-Chain® removable along both radii
- ❷ Hinged snap-open removable lids along outer radius
- ❸ Stop dog with "brake" for noise reduction
- ❹ Wide, rounded plastic crossbars - cable friendly
- ❺ Optimized glide pads with lateral wear allowance
- ❻ Numerous interior separation possibilities
- ❼ Closed and open styles can be combined
- ❽ Dirt-repellent exterior
- ❾ E-Chains® also available with reverse bending radius "RBR"

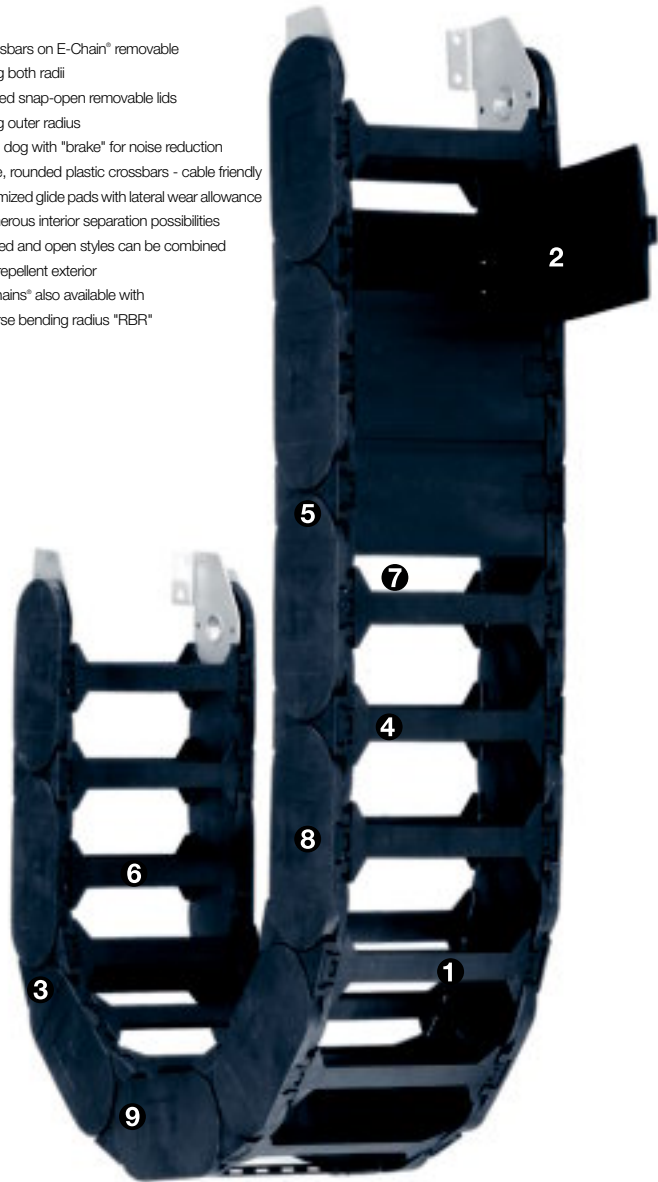

Order example complete E-Chain®

Please indicate chain-lengths or number of links Example: 6 m or 42 links

6 m 600.30.300.0



E-Chain®

with 2 separators 6011 assembled every 2" link



Interior separation

1 set 6000.1.12



Mounting bracket



Unsupported length

FL_G = with straight upper run

FL_B = with permitted sag

Further information ► **Design, page 1.12**

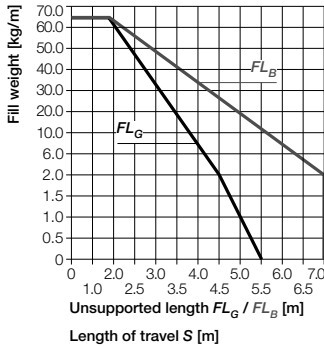
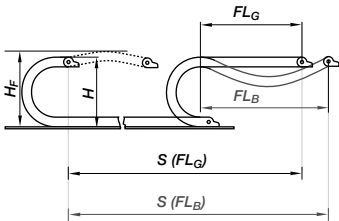

- S = Length of travel
- R = Bending radius
- H = Nominal clearance height
- H_F = Required clearance height
- H_{R1} = Trough inner height
- D = Overlength E-Chain" radius in final position
- $K = \pi \cdot R + \text{"safety"}$
- D_2 = Over length - long travels, gliding
- K_2 = "Further add-on
- H_2 = "Mounting height

*if the mounting bracket location is set lower

Other installation methods

- Vertical, hanging ≤ 120 m
- Vertical, standing ≤ 6 m
- Side mounted, un supp. ≤ 6 m
- Rotary requires further calculation
- Unsupported length of upper run = upon request

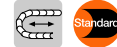

Short travels - unsupported

Unsupported E-Chains" feature positive camber over short travels. This must be accounted for when specifying the clearance height H_F . Please consult igus" if space is particularly restricted.

The required clearance height:
 $H_F = H + 100$ mm
(with 5,0 kg/m fill weight)

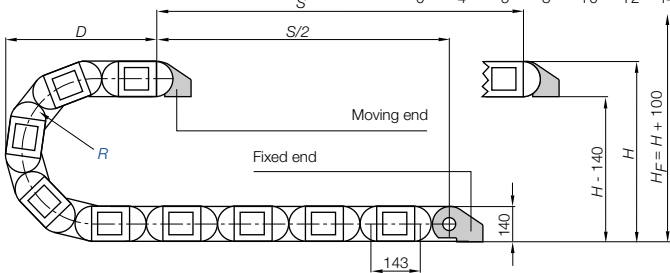

Pitch = 143 mm/link Links/m = 7 (1001 mm) Chain length = $S/2 + K$

R	200	250	300	350	400	450	500	550	600	750	1000
H	545	645	745	845	945	1045	1145	1245	1345	1645	2145
D	415	465	515	565	615	665	715	765	815	965	1215
K	920	1080	1240	1400	1560	1720	1870	2020	2175	2660	3435
H ₂	325	325	325	325	325	325	325	325	325	325	-
D ₂ *25	900	1000	1100	1250	1450	1600	1700	1900	2050	2850	-
K ₂	1573	1716	1859	2288	2574	2860	3146	3432	3861	5005	-

Long travel lengths from 10 m to max. 450 m Chain length = $S/2 + K_2$

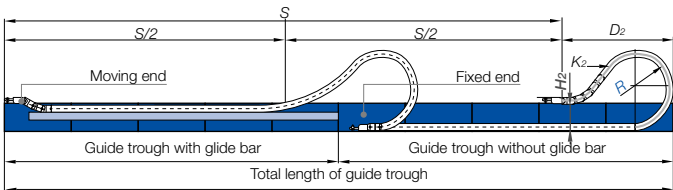

In case of travels between 4 and 10 m we recommend a longer unsupported length.



Gliding, long travel applications (max. 450 m)

In this case the E-Chain" upper run will be introduced in a guide trough on the lower run. We recommend to realize the engineering of such a plant by our technicians.

Speed / acceleration FL_G	max. 20 [m/s] / max. 200 [m/s ²]
Speed / acceleration FL_B	max. 3 [m/s] / max. 6 [m/s ²]
Gliding speed / acceleration (maximum)	max. 10 [m/s] / max. 50 [m/s ²]
Material - permitted temperature °C	igumid G / -40° up to +120° C
Flammability class, igumid G	VDE 0304 IIC UL94 HB

Technical Data



Details of material properties

► page 1.38

108

System E4/00
Inner height: 108 mm

Phone +49- (0) 22 03-96 49-800
Fax +49- (0) 22 03-96 49-222



► page 7.161

igus® E-ChainSystems®

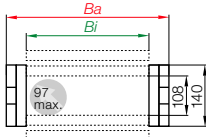

Part No. structure

600. 30. 300. 0



Series 600 - E-Chain® with crossbars every link

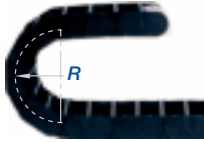

- Crossbars every link
- For rigid hydraulic hoses
- For applications particularly demanding
- Can be opened from two sides



Phone+49- (0) 22 03-96 49-800
Fax +49- (0) 22 03-96 49-222

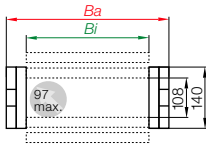

Part No. structure

601. 30. 300. 0



Series 601 - E-Chain® with crossbars every 2nd link

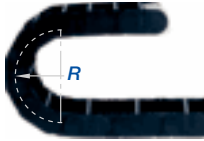

- Crossbars every 2nd link = Standard
- For nearly every situation
- Can be opened from two sides
- Easy assembly
- Stable
- Attractive price



igus® GmbH
51147 Cologne

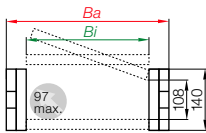

Part No. structure

608. 30. 300. 0



Series R608 - Fully enclosed E-Tube

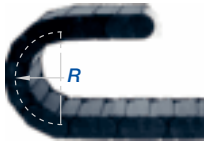

- Fully enclosed
- Excellent cable protection against dirt
- Protection against hot chips (up to 900°C)
- Lids along the entire inner radius are completely removable. Lids along the entire outer radius are single sided snap-open with a hinge on the other side to keep them attached to the chain or completely removable.



Internet: www.igus.eu
E-mail: info@igus.de

Part No.	<i>Bi</i> [mm]	<i>Ba</i> [mm]	600 [kg/m]	601 [kg/m]	R608 [kg/m]
600/601/608.20... <input type="text"/> .0	200	252	≈ 8,75	≈ 7,99	**
600/601/608.25... <input type="text"/> .0	250	302	≈ 9,11	≈ 8,17	**
600/601/608.30... <input type="text"/> .0	300	352	≈ 9,45	≈ 8,34	**
600/601.32... <input type="text"/> .0	320	372	≈ 9,59	≈ 8,41	-
600/601/608.35... <input type="text"/> .0	350	402	≈ 9,74	≈ 8,48	**
600/601/608.40... <input type="text"/> .0	400	452	≈ 10,19	≈ 8,71	**
600/601.45... <input type="text"/> .0	450	502	≈ 10,32	≈ 8,77	-
600/601.50... <input type="text"/> .0	500	552	≈ 10,63	≈ 8,93	-
600/601.55... <input type="text"/> .0	550	602	≈ 10,98	≈ 9,10	-
600/601.60... <input type="text"/> .0	600	652	≈ 11,47	≈ 9,35	-

Hot Chips up to 850°C

E-Tubes that repel hot chips, up to 850°C. Some applications, depending on amount and size of the chips, can burn or melt the surface. That is no longer the case with the igus® "igumid HT" material. Order example: Full E-Tube made of HT: **608.40.250.0.HT**
Lids made of HT: **608.40.HTE.250.0**
*for long travels upon request
Further Information: www.igus.de/en/HT
Delivery time up to 4 weeks!



Extension links for extremely wide E-Chains®
► upon request

Available bending radii

R [mm] *

Supplement Part No. with required radius. Example: 600.30..0

0 = standard color, other colors ► page 1.39 · Pitch = 143 mm/link - Links/m = 7

*not available for R608 **upon request

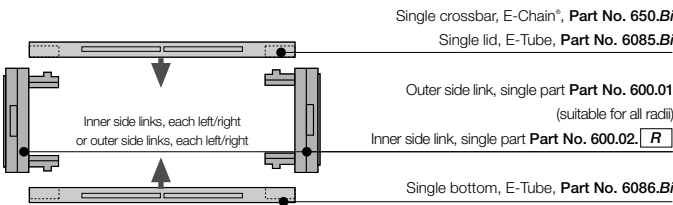

Part No. E-Chain® links, single parts

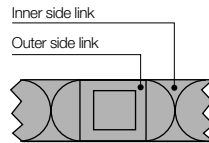

System E4/00
Inner height: 108 mm

Phone +49- (0) 22 03-96 49-800
Fax +49- (0) 22 03-96 49-222



► page 7.161



Vertical separators are used if a vertical subdivision is required. In the standard configuration, a separator is mounted at every second link. **Note:** Observe a lateral spacing of at least 32 mm (E-Tube) and 6 mm (E-Chain)!

Exception: Minimum spacing
Locking separator 6008 = 23 mm

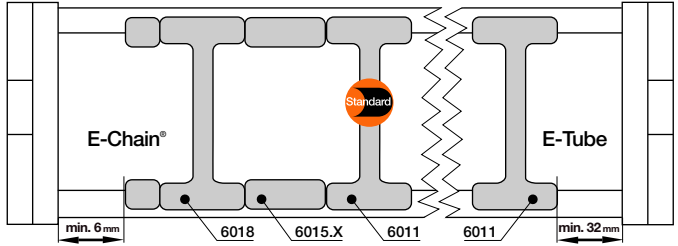

Vertical separator
6001



Spacer
6005.XX



Locking separator
6008

Vertical separator for E-Chains®/E-Tubes

unassembled	6001
assembled	6011



Spacer*, for E-Chains®

unassembled	6005.XX
assembled	6015.XX



Locking separator for E-Chains®

unassembled	6008
assembled	6018

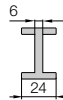

*For side-mounted applications

Option 1: Vertical separators and spacers

- **Standard separator 6001** for E-Chains® and E-Tubes offers safe stability due to its wide base design, also when used with thick cables or hoses.

- Separators (e.g. "side mounted") for E-Chains® can be fixed in their position with **Spacers 6005.XX**. The available inner height will be reduced by 2 mm, per spacer and side. To avoid this, the parts can be assembled on outside of the crossbar (not for long travels) **XX = width of the spacer** (available 10, 15, 20 mm)

Additionally:

- **Locking separator 6008** for E-Chains® - with increased retention force for applications exposed to very high humidity or extreme loads. The extra retention force is achieved by asymmetric claws for the crossbar. Ensure proper alignment.

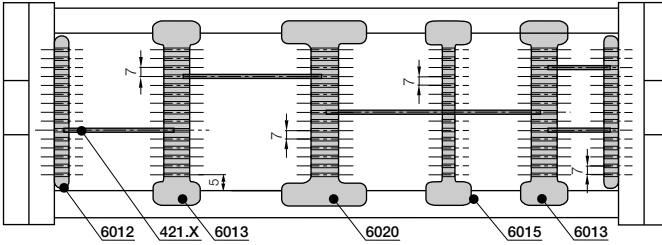

For use with many cables of differing diameters. E-Chains® and E-Tubes can be subdivided both vertically and horizontally. The shelves can be arranged elevator-shifted with different bottoms

Option 2: Shelves

● Side plates 6002, middle plates 6003 and shelves 420.X form the basic pattern of a shelf system. Shelves of various widths can be arranged at 15 different heights (in 7 mm increments).

● Locking vertical separator 6010 combined with shelves. Triple slots (only for E-Chains®).

● Slotted separators 6004 are used for very fine subdivisions. However, they cannot be retrofitted into an existing separation system without dismantling the interior separators first.

● The unilateral open slotted separator 6005 can be retrofitted into an existing interior separation system without a need for dismantling the interior separators. During an installation of open slotted separators, the top and bottom notches cannot be occupied by shelves.

4,5
15,5

Side plate for E-Chains®/E-Tubes

unassembled	6002
assembled	6012

8
17

Middle plate for E-Chains®/E-Tubes

unassembled	6003
assembled	6013

8
24

Locking vertical separator for E-Chains®

unassembled	6010
assembled	6020

6
24

Slotted separator for E-Chains®/E-Tubes

unassembled	6004
assembled	6014

4
14

Open slotted separator for E-Chains®/E-Tubes

unassembled	6005
assembled	6015

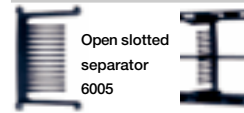
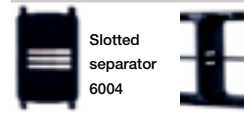

Width X [mm]	Part No. unassembled	Part No. assembled
018	420.18	421.18
023	420.23	421.23
025	420.25	421.25
028	420.28	421.28
033	420.33	421.33
043	420.43	421.43
050	420.50	421.50
062	420.62	421.62

Width X [mm]	Part No. unassembled	Part No. assembled
075	420.75	421.75
088	420.88	421.88
100	420.100	421.100
125	420.125	421.125
150	420.150	421.150
175	420.175	421.175
187	420.187	421.187
200	420.200	421.200

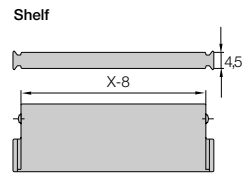

System E4/00
Inner height: 108 mm

Phone +49- (0) 22 03-96 49-800
Fax +49- (0) 22 03-96 49-222

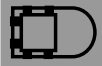

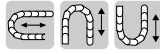

Option steel - pivoting

- For pivoting connections
- One part (two-piece) for all chain widths
- Electrically conductive

Moving end
6000.1

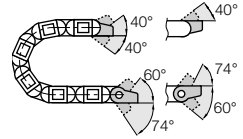

Fixed end
6000.2

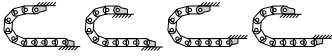

Possible installation conditions -
Further installation angles ► installation sketch

Dimensions and order configurations

Moving end
6000.1

Fixed end
6000.2

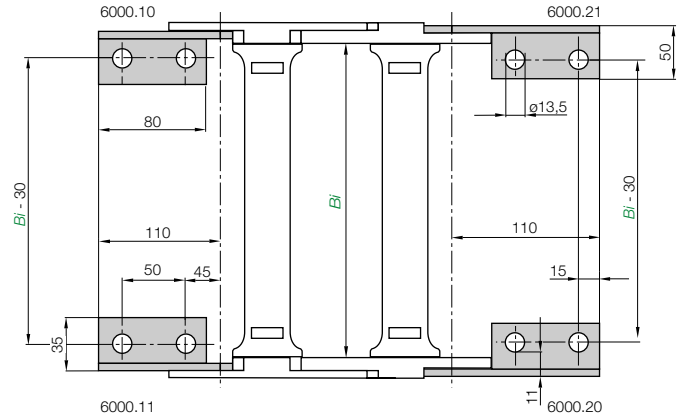

Note mounting brackets:
Depending on the E-Chain® length, the carrier will end with outer or inner side links. For the best appearance, make sure the chain ends with outer side link whenever possible. An odd number of links will always end with outer side links.

Part No.	Mounting bracket
6000.1.12	Full attachment set (both sides) for E-Chain®, ending with outer side link
6000.3.12	Full attachment set (both sides) for E-Chain®, beginning with outer side link (moving end), ending with inner side link (fixed end)
6000.1	Mounting bracket set moving end (one side) for outer side link
6000.2	Mounting bracket set fixed end (one side) for inner side link

Phone+49- (0) 22 03-96 49-800
Fax +49- (0) 22 03-96 49-222

igus® GmbH
51147 Cologne

Internet: www.igus.eu
E-mail: info@igus.de

E4/00 | Series 600-601·R608 | Accessories | Strain Relief



Tiewrap plate as individual part

As individual component screwed on KMA. Can be plugged in the mounting brackets. **Details ► chapter 10**

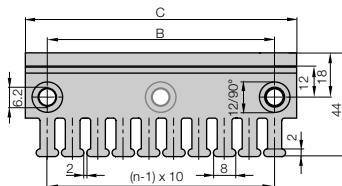
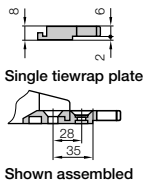

Tiewrap plate	No. of teeth n	Dim. C [mm]	Dim. B [mm]	Center bore
3050.ZB	5	50	30	-
3075.ZB	7	75	55	-
3100.ZB	10	100	80	-
3115.ZB	11	115	95	-
3125.ZB	12	125	105	-
3150.ZB	15	150	130	-
3175.ZB	17	175	155	-
3200.ZB	20	200	180	+
3225.ZB	22	225	205	+
3250.ZB	25	250	230	+

(- = no / + = yes)

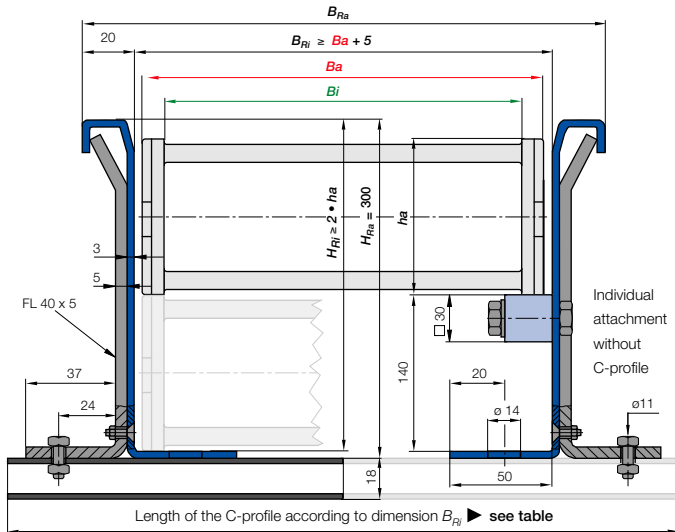

- B_a = Outer width E-Chains* / E-Tube
- B_i = Inner width E-Chains* / E-Tube
- h_a = Outer height E-Chains* / E-Tube
- H_{Ri} = Inner trough height
- H_{Ra} = Outer trough height
- B_{Ri} = Inner trough width ▶ depends on dim. B_a
- B_{Ra} = Outer trough width
- n_{Mon} = Number of installation sets (left/right)
- n_{Ri} = Number of trough sets (left/right)
- $H_{Ri} \geq 2 \cdot h_a$
- $B_{Ri} \geq B_a + 5$
- = Guide trough set ● = Glide bar
- = Installation set ● = C-profile

Installation set with C-profile

600.20.300.0 ▶ Order example

B_{Ri}	Part No.	Installation set
.20	257	98.50.375
.25	307	98.50.425
.30	357	98.50.475
.32	377	98.50.500
.35	407	98.50.525
.40	457	98.50.575
.45	507	98.50.625
.50	557	98.50.675
.55	607	98.50.725
.60	657	98.50.775

Guide troughs are used with applications where the upper run of the E-Chain™ glides on the lower run. If using igus® steel guide troughs, the following components are required:

- **Guide trough without glide bars**
Part No. 98.30
- **Guide trough with glide bars**
Part No. 98.31
- **Installation sets as end connectors**
Part No. 98.50.XX

.XX indicates the length of the C-profile on which the guide trough is mounted. The values and part numbers are specified in the table on the left. Standard length of the trough components and glide bars is 2 m. The required overall length of the guide trough directly correlates to the length of travel. Special dimensions are available for confined spaces.

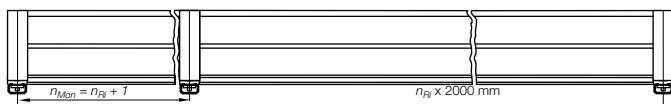

Illustration top: Guide trough with and without glide bar. Illustration bottom: installation set

Order example: Length of travel 30 m - Center mounted for Series 600.30.300.0 with $B_{Ri} = 357$

- Guide trough set (set of 2 trough side parts, incl. glide strips) **without** glide bar
Order text: 16 m Guide trough without glide bar (8 x 2 m sections) Part No. **98.30**
- Guide trough set (set of 2 trough side parts, incl. glide strips) **with** glide bar
Order text: 16 m Guide trough with glide bar (8 x 2 m sections) Part No. **98.31**
- Installation set "Basic" complete (Guide trough-sets + 1)
Order text: 17 Installation sets (with C-profile) Part No. **98.50.475**

Principle sketch: Number of installation sets to be installed = **Number of trough sections + 1**





Price index

 This E4 Series is a
 "Low-noise-Version"

 Cleanroom test
 upon request

 ESD classification:
 Electrically conductive ESD/ATEX
 version upon request

Opening E-Chains: Remove crossbars and clips - Insert screwdriver into the slot, push down, release by lever action. Repeat action for the other side



When to use the Series 640:

- If a low-noise version is required
- At very high speeds and/or accelerations
- For long travels
- For high additional loads



When not to use it:

- If a simple and low-cost solution is required
 - ▶ Series 1640, page 7.90
- If higher stability is required
 - ▶ Series 600/601/R608, page 7.200
- If an enclosed solution is required
 - ▶ Series R608, page 7.200

- ① Optimum ratio of inner height to outer height
- ② Numerous interior separation possibilities
- ③ Stop dog with "brake" for noise reduction
- ④ Wide, rounded plastic crossbars - cable friendly
- ⑤ Optimized glide pads with lateral wear allowance
- ⑥ Dirt-repellent exterior
- ⑦ E-Chains® also available with reverse bending radius "RBR"
- ⑧ Crossbars are removable along both radii

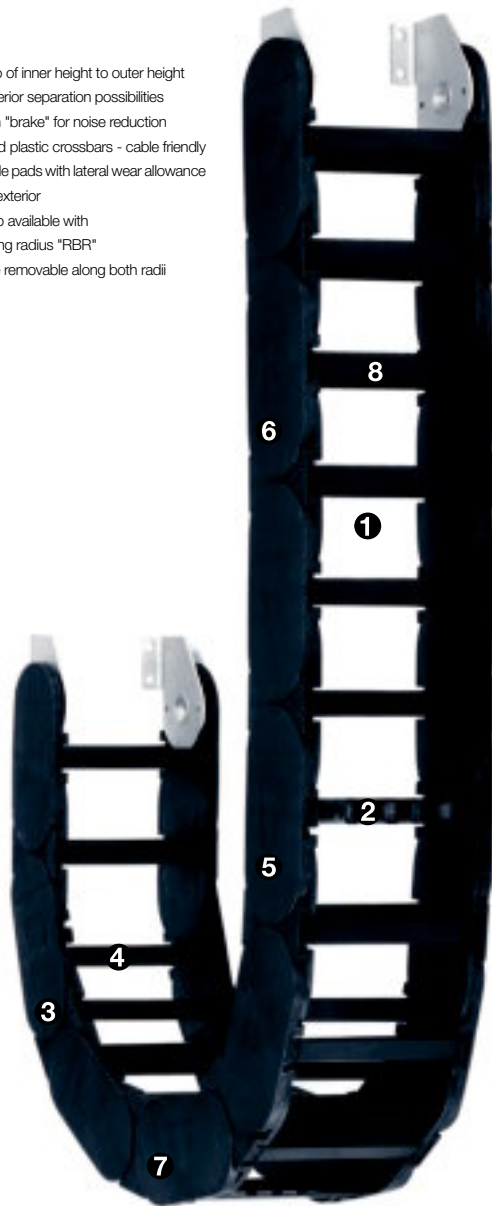

Order example complete E-Chain®

Please indicate chain-lengths or number of links Example: 4 m or 28 links

4 m 640.33.300.0



E-Chain®

with 2 separators 6411 assembled every 2" link



Interior separation

1 set 6000.1.12



Mounting bracket



Unsupported length

FL_G = with straight upper run

FL_B = with permitted sag

Further information ► **Design, page 1.12**

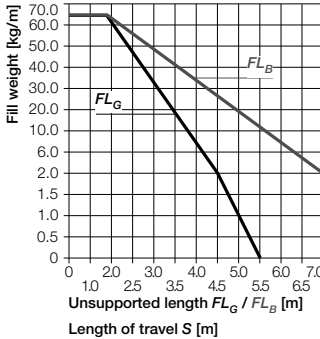
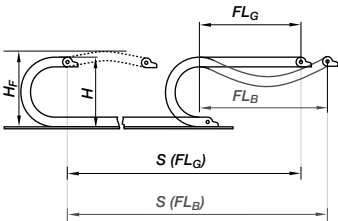

- S = Length of travel
- R = Bending radius
- H = Nominal clearance height
- H_F = Required clearance height
- H_{R1} = Trough inner height
- D = Overlength E-Chain" radius in final position
- $K = \pi \cdot R + \text{"safety"}$
- D_2 = Over length - long travels, gliding
- K_2 = "Further add-on
- H_2 = "Mounting height

*If the mounting bracket location is set lower

Other installation methods

- Vertical, hanging ≤ 120 m
- Vertical, standing ≤ 6 m
- Side mounted, un supp. ≤ 4 m
- Rotary requires further calculation
- Unsupported length of upper run = upon request

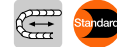

Short travels - unsupported

Unsupported E-Chains" feature positive camber over short travels. This must be accounted for when specifying the clearance height H_F . Please consult igus" if space is particularly restricted.

The required clearance height:

$H_F = H + 100$ mm
(with 5,0 kg/m fill weight)

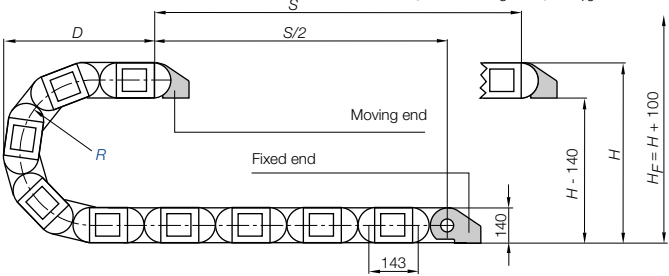

Pitch = 143 mm/link Links/m = 7 (1001 mm) Chain length = $S/2 + K$

R	200	250	300	350	400	450	500	550	600	750	1000
H	545	645	745	845	945	1045	1145	1245	1345	1645	2145
D	415	465	515	565	615	665	715	765	815	965	1215
K	920	1080	1240	1400	1560	1720	1870	2020	2175	2660	3435
H ₂	325	325	325	325	325	325	325	325	325	325	-
D ₂ *25	800	900	1100	1200	1430	1580	1700	1850	2050	2850	-
K ₂	1287	1430	1859	2145	2574	2860	3146	3432	3861	5005	-

Long travel lengths from 10 m to max. 450 m Chain length = $S/2 + K_2$

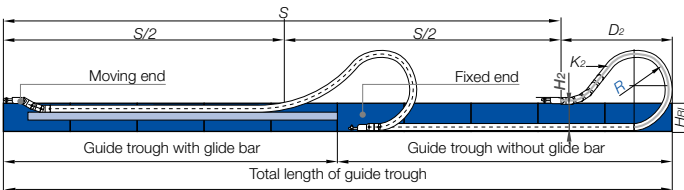

In case of travels between 4 and 10 m we recommend a longer unsupported length.



Gliding, long travel applications (max. 450 m)

In this case the E-Chain" upper run will be introduced in a guide trough on the lower run. We recommend to realize the engineering of such a plant by our technicians.

Technical Data

Speed / acceleration FL_G	max. 20 [m/s] / max. 200 [m/s ²]
Speed / acceleration FL_B	max. 3 [m/s] / max. 6 [m/s ²]
Gliding speed / acceleration (maximum)	max. 10 [m/s] / max. 50 [m/s ²]
Material - permitted temperature °C	igumid G / -40° up to +120° C
Flammability class, igumid G	VDE 0304 IIC UL94 HB



Details of material properties
► page 1.38

112
System E4/00
Inner height: 112 mm

Phone +49- (0) 22 03-96 49-800
Fax +49- (0) 22 03-96 49-222

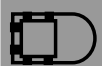

► page 7.161

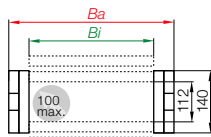

Part No. structure

640. 33. 300. 0



Series 640 - E-Chain® with crossbars every link

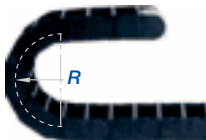

- Crossbars every link
- For rigid hydraulic hoses
- For applications particularly demanding
- Can be opened from two sides



Part No.	<i>Bi</i> [mm]	<i>Ba</i> [mm]	Weight [kg/m]
640.12. [] .0	87	139	≈ 7,57
640.13. [] .0	99	152	≈ 7,66
640.15. [] .0	112	164	≈ 7,70
640.16. [] .0	124	177	≈ 7,77
640.17. [] .0	137	189	≈ 7,84
640.18. [] .0	149	202	≈ 7,91
640.20. [] .0	162	214	≈ 7,92
640.21. [] .0	174	227	≈ 7,99
640.22. [] .0	187	239	≈ 8,04
640.23. [] .0	199	252	≈ 8,12
640.25. [] .0	212	264	≈ 8,18
640.26. [] .0	224	277	≈ 8,23
640.27. [] .0	237	289	≈ 8,30
640.28. [] .0	249	302	≈ 8,32
640.30. [] .0	262	314	≈ 8,39
640.31. [] .0	274	327	≈ 8,46
640.32. [] .0	287	339	≈ 8,51
640.33. [] .0	300	352	≈ 8,62
640.35. [] .0	312	364	≈ 8,68
640.36. [] .0	324	377	≈ 8,72
640.37. [] .0	337	389	≈ 8,74
640.38. [] .0	349	402	≈ 8,79
640.40. [] .0	362	414	≈ 8,92
640.41. [] .0	374	427	≈ 9,02
640.42. [] .0	387	439	≈ 9,11
640.43. [] .0	399	452	≈ 9,16
640.45. [] .0	412	464	≈ 9,20
640.46. [] .0	424	477	≈ 9,21
640.47. [] .0	437	489	≈ 9,26
640.48. [] .0	449	502	≈ 9,30
640.50. [] .0	462	514	≈ 9,38
640.51. [] .0	474	527	≈ 9,39
640.52. [] .0	487	539	≈ 9,42
640.53. [] .0	499	552	≈ 9,52
640.55. [] .0	512	564	≈ 9,83
640.60. [] .0	562	614	≈ 9,95

Available bending radii

R [mm]

Supplement Part No. with required radius. Example: 640.33.[300].0

0 = standard color, other colors ▶ page 1.39 - Pitch = 143 mm/link - Links/m = 7

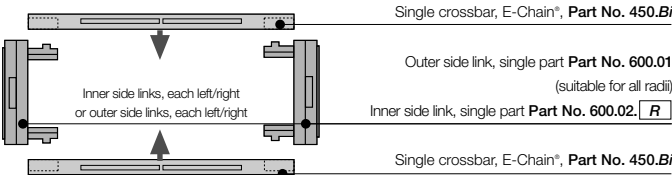

Part No. E-Chain® links, single parts

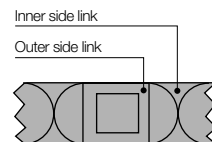

System E4/00
Inner height: 112 mm

Phone +49- (0) 22 03-96 49-800
Fax +49- (0) 22 03-96 49-222



▶ page 7.161



Vertical separators are used if a vertical subdivision is required. In the standard configuration, a separator is mounted at every second link.

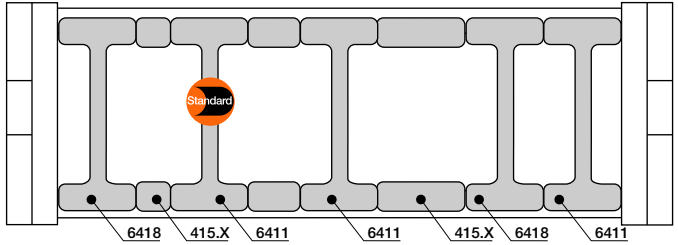

Vertical separator
6401



Spacer
405.XX



Locking separator
6408

Vertical separator for E-Chains®

unassembled	6401
assembled	6411



Spacer* for E-Chains®

unassembled	405.XX
assembled	415.XX



Locking separator for E-Chains®

unassembled	6408
assembled	6418



*For side-mounted applications

Option 1: Vertical separators and spacers

- **Standard separator 6401** for E-Chains® offers safe stability due to its wide base design, also when used with thick cables or hoses.

- Separators (e.g. "side mounted") for E-Chains® can be fixed in their position with **Spacers 405.XX**. The available inner height will be reduced by 2 mm, per spacer and side. To avoid this, the parts can be assembled on outside of the crossbar (not for long travels)
XX = width of the spacer (available 10, 15, 20, 30, 40 mm)

Additionally:

- The **Locking separator for E-Chains® 6408** is designed for applications exposed to extremely high humidity, for example, at composting plants. The lateral cam serves for uniform alignment of the vertical separators; if these separators are misaligned, they will inevitably get damaged on an attempt to open the E-Chain®.

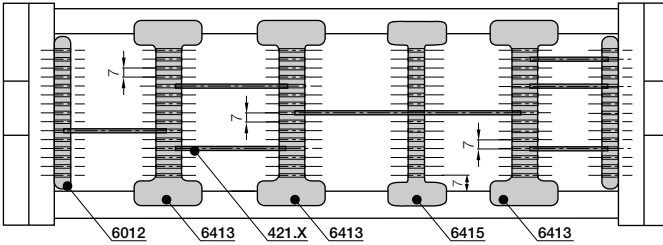

For use with many cables of differing diameters. E-Chains[®] and E-Tubes can be subdivided both vertically and horizontally. The shelves can be arranged elevator-shifted with different bottoms

Option 2: Shelves

● Side plates 6002, middle plates 6403 and shelves 420.X form the basic pattern of a shelf system. Shelves of various widths can be arranged at 15 different heights (in 7 mm increments).

● The unilateral open slotted separator 6405 can be retrofitted into an existing interior separation system without a need for dismantling the interior separators. During an installation of open slotted separators, the top and bottom notches cannot be occupied by shelves.

	Side plate for E-Chains[®]	
	unassembled	6002
	assembled	6012

	Middle plate for E-Chains[®]	
	unassembled	6403
	assembled	6413

	Open slotted separator for E-Chains[®]	
	unassembled	6405
	assembled	6415

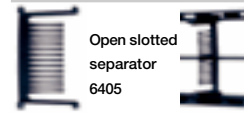

Width X [mm]	Part No. unassembled	Part No. assembled
018	420.18	421.18
023	420.23	421.23
025	420.25	421.25
028	420.28	421.28
033	420.33	421.33
043	420.43	421.43
050	420.50	421.50
062	420.62	421.62

Width X [mm]	Part No. unassembled	Part No. assembled
075	420.75	421.75
088	420.88	421.88
100	420.100	421.100
125	420.125	421.125
150	420.150	421.150
175	420.175	421.175
187	420.187	421.187
200	420.200	421.200

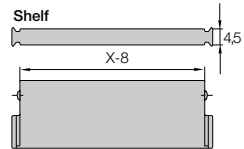

Additional elements for interior separation

	Rollclip	
	unassembled	489.27
	assembled	490.27

Rollclip - minimizes abrasion of particularly sensitive hoses. The Rollclip is simply clamped onto the opening crossbar. The movable rollers compensate for relative movement between the chain and hose.



System E4/00
Inner height: 112 mm

Phone +49- (0) 22 03-96 49-800
Fax +49- (0) 22 03-96 49-222





Consult igus® for your extender crossbar applications. We are happy to assist you with your design layout

Extender crossbars - careful guide of hoses applications

- Suitable for hoses with a maximum outer diameter of 300 mm
- Gliding operation with crossbars assembled along the outer radius and a special guide trough
- Gliding operation not guaranteed with crossbars assembled along the inner radius
- The extender crossbar can either be attached to the side links directly or can be used in combination with two stranded snap-open crossbars

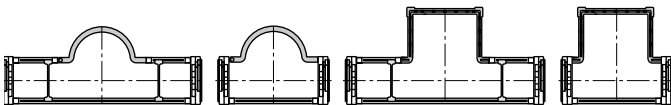

Round extender crossbar with snap-open crossbars

Attached directly to the side link

Square extender crossbar with snap-open crossbars

Attached directly to the side link

Part No.	Max Ø [mm] hose	Form	Installation side link	Combination with snap-open crossb.
450.15.RHD115	115	○	-	+
450.17.RD115	115	○	+	-
450.25.D150	150	□	+	-
450.30.D200	200	□	+	-
450.35.D250	250	□	+	-
450.40.D300	300	□	+	-
450.20.HD150	150	□	-	+
450.25.HD200	200	□	-	+
450.30.HD250	250	□	-	+

○ = round □ = square + = yes / - = no

Phone +49- (0) 22 03-96 49-800
Fax +49- (0) 22 03-96 49-222

igus® GmbH
51147 Cologne



E4 clip-on cable binder

- For side-mounted applications
- Serves as a clip-on, lateral guide for hoses and cables on E-Chains®
- The loops can be adjusted as required
- Compatible with many E4 E-Chains®
- Stylish and economical
- One clip and one locking band are needed for each chain link
- Call us if you have any questions on project planning

Part No.	Form
450.B12	Locking clip, comprising a locking element
450.B12.200	Locking band, comprising a locking element and band; 12 x 1,5 x 200 mm

Internet: www.igus.eu
E-mail: info@igus.de



Option steel - pivoting

- For pivoting connections
- One part (two-piece) for all chain widths
- Electrically conductive

Moving end
6000.1

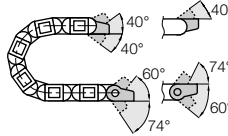

Fixed end
6000.2

Possible installation conditions -
Further installation angles ► installation sketch

Moving end
6000.1

Fixed end
6000.2

Dimensions and order configurations

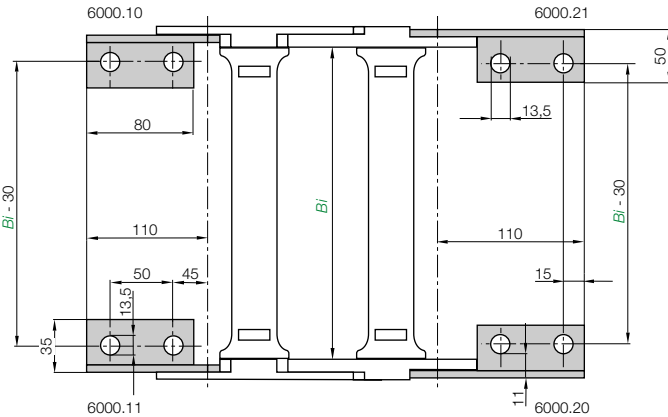

Part No. Mounting bracket

6000.1	1.12	Full attachment set (both sides) for E-Chain®, ending with outer side link
6000.3	1.12	Full attachment set (both sides) for E-Chain®, beginning with outer side link (moving end), ending with inner side link (fixed end)
6000.1		Mounting bracket set moving end (one side) for outer side link
6000.2		Mounting bracket set fixed end (one side) for inner side link

Note mounting brackets:

Depending on the E-Chain® length, the carrier will end with outer or inner side links. For the best appearance, make sure the chain ends with outer side link whenever possible. An odd number of links will always end with outer side links.

E4/00 | Series 640 | Accessories | Strain Relief

Tiewrap plate	No. of teeth	Dim. C [mm]	Dim. B [mm]	Center bore
3050.ZB	5	50	30	-
3075.ZB	7	75	55	-
3100.ZB	10	100	80	-
3115.ZB	11	115	95	-
3125.ZB	12	125	105	-
3150.ZB	15	150	130	-
3175.ZB	17	175	155	-
3200.ZB	20	200	180	+
3225.ZB	22	225	205	+
3250.ZB	25	250	230	+

Tiewrap plate as individual part

As individual component screwed on KMA. Can be plugged in the mounting brackets. **Details ► chapter 10**

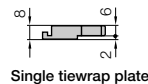
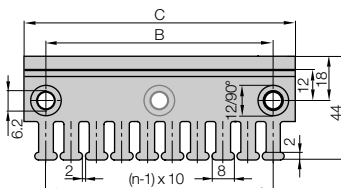

Single tiewrap plate

Shown assembled

Phone +49- (0) 22 03-96 49-800
Fax +49- (0) 22 03-96 49-222



► chapter 10



► page 7.161

- Ba** = Outer width E-Chains® / E-Tube
 - Bi** = Inner width E-Chains® / E-Tube
 - ha** = Outer height E-Chains® / E-Tube
 - H_{Ri}** = Inner trough height
 - H_{Ra}** = Outer trough height
 - B_{Ri}** = Inner trough width ▶ depends on dim. Ba
 - B_{Ra}** = Outer trough width
 - n_{Mon}** = Number of installation sets (left/right)
 - n_{Ri}** = Number of trough sets (left/right)
 - H_{Ri} ≥ 2 • ha**
 - B_{Ri} ≥ Ba + 5**
- = Guide trough set ● = Glide bar
 - = Installation set ● = C-profile

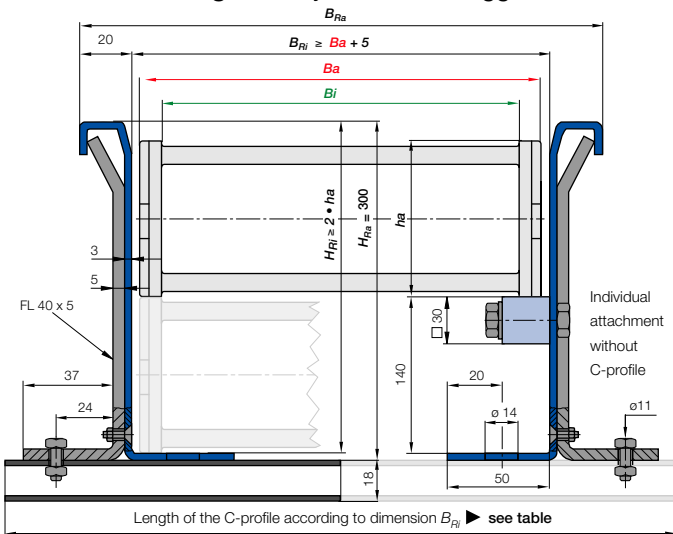

Installation set with C-profile

640.12.300.0 ▶ Order example

	Part No.	Installation set
.12	144	98.50.275
.13	157	98.50.275
.15	169	98.50.300
.16	182	98.50.300
.17	194	98.50.325
.18	207	98.50.325
.20	219	98.50.350
.21	232	98.50.350
.22	244	98.50.375
.23	257	98.50.375
.25	269	98.50.400
.26	282	98.50.400
.27	294	98.50.425
.28	307	98.50.425
.30	319	98.50.450
.31	332	98.50.450
.32	344	98.50.475
.33	357	98.50.475
.35	369	98.50.500
.36	382	98.50.500
.37	394	98.50.525
.38	407	98.50.525
.40	419	98.50.550
.41	432	98.50.550
.42	444	98.50.575
.43	457	98.50.575
.45	469	98.50.600
.46	482	98.50.600
.47	494	98.50.625
.48	507	98.50.625
.50	519	98.50.650
.51	532	98.50.650
.52	544	98.50.675
.53	557	98.50.675
.55	569	98.50.700
.60	619	98.50.750

Guide troughs are used with applications where the upper run of the E-Chain® glides on the lower run. If using igus® steel guide troughs, the following components are required:

- **Guide trough without glide bars**
Part No. 98.30
- **Guide trough with glide bars**
Part No. 98.31
- **Installation sets as end connectors**
Part No. 98.50.XX

XX indicates the length of the C-profile on which the guide trough is mounted. The values and part numbers are specified in the table on the left. Standard length of the trough components and glide bars is 2 m. The required overall length of the guide trough directly correlates to the length of travel. Special dimensions are available for confined spaces.



Illustration top: Guide trough with and without glide bar. Illustration bottom: installation set

Order example: Length of travel 30 m - Center mounted for Series 640.33.300.0 with B_{Ri} = 357

- Guide trough set (set of 2 trough side parts, incl. glide strips) **without** glide bar
Order text: 16 m Guide trough without glide bar (8 x 2 m sections) Part No. 98.30
- Guide trough set (set of 2 trough side parts, incl. glide strips) **with** glide bar
Order text: 16 m Guide trough with glide bar (8 x 2 m sections) Part No. 98.31
- Installation set "Basic" complete (Guide trough-sets + 1)
Order text: 17 Installation sets (with C-profile) Part No. 98.50.475

Principle sketch: Number of installation sets to be installed = **Number of trough sections + 1**



Phone+49- (0) 22 03-96 49-800
 Fax +49- (0) 22 03-96 49-222

igus® GmbH
 51147 Cologne

Internet: www.igus.eu
 E-mail: info@igus.de

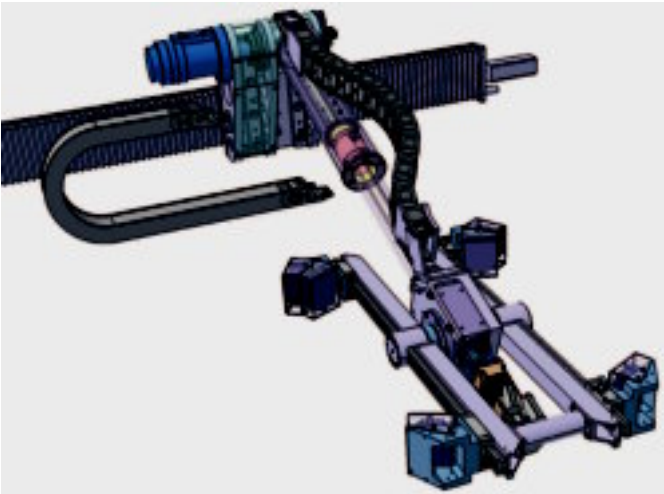

Friction welding machine - Special E4/00 version bend in two directions

System E4/00
Inner height: 112 mm

Phone +49- (0) 22 03-96 49-800
Fax +49- (0) 22 03-96 49-222



► chapter 9



► page 7.161





E4/4

For new designs: E4.1

E4/4 - The E4.1 predecessor for long travels and side-mounted applications

System E4/4 (pronounced: E-4-4) come out to solve applications in two areas: The extreme long travels and the free-hanging side mounted situations. The famous undercut between two links is one feature to make that possible. Push-forces and rigidity are increased - tolerance against dirt and debris rises. Special "Roller-links" establishes E4/4 as the true long-travel specialist. The undercut design also enables the excellent ESD/ATEX performance. The chain links are tightly linked to each other, so that electricity can flow through them when in contact with each other (Please note: This is valid only for the special conductive material igumid ESD and is not applicable for the standard series in this catalog)

Typical industries and applications

- Unsupported, side mounted applications
- Cranes: RTG, Quay cranes, many more
- Compost plants
- Construction machines
- Gypsum plants, concrete plants, chemical plants
- Agricultural plants
- ESD applications
- Heavy machinery
- Steel plants
- Shipyards
- General machinery



ATEX/ESD: Excellent performance with the special material igumid ESD (upon request) "Rear grip" achieves long-term electrical conductivity



Side-mounted - unsupported



High torsional rigidity



System E4/4 approved with long travels



System E4 - 4-piece E-Chain® links





Many successful Rol E-Chain® applications, i.e. one of the igus® longest travels at the moment on 2 ship unloaders in Malaysia, both equipped with a Rol E-Chain® at 441,3 m travel length

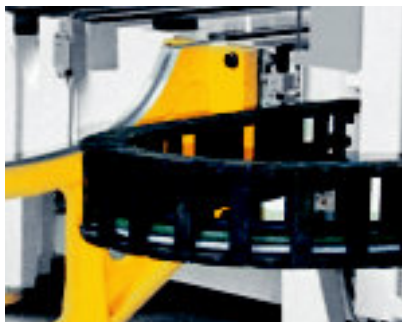

Special case: Side-mounted, unsupported - undercut design offers stability



200 m travels and more possible

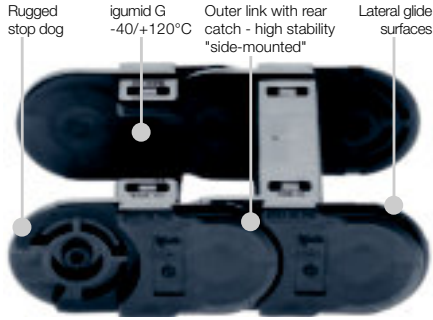

- Best unsupported lengths "side-mounted"
- Rol E-Chain™ links available
- For very long travels up to 150 - 250 m
- High torsional rigidity
- Good for tough environments with dirt and debris
- ESD Version available
- Interior separation tool box available
- You can find more technical data about the material, chemical resistance, temperatures ► **Design, from page 1.38**

Selection table

Series	Inner height <i>hi</i> [mm]	Inner width <i>Bi</i> [mm]	Outer width <i>Ba</i> [mm]	Outer height <i>ha</i> [mm]	Bending radius <i>R</i> [mm]	Unsupported length max. [m]	page
--------	--------------------------------	-------------------------------	-------------------------------	--------------------------------	---------------------------------	-----------------------------	------

Crossbars every link
 for particularly demanding applications

2828	32	50 - 400	74 - 424	54	63 - 300	3,00	7.224
3838	42	50 - 400	77 - 427	64	75 - 350	3,80	7.236
4040	56	50 - 600	86 - 636	84	135 - 500	4,50	7.248
4040HD	56	50 - 600	104 - 654	84	135 - 300	4,50	7.260
5050	80	50 - 600	100 - 650	108	150 - 1000	6,00	7.268
5050HD	80	50 - 600	110 - 660	108	200 - 500	6,00	7.280

Crossbars every 2nd link
 for almost all applications

2928	32	50 - 400	74 - 424	54	63 - 300	3,00	7.224
3938	42	50 - 400	77 - 427	64	75 - 350	3,80	7.236
4140	56	50 - 600	86 - 636	84	135 - 500	4,50	7.248
5150	80	50 - 600	100 - 650	108	150 - 1000	6,00	7.268

E-Tubes

 fully enclosed,
 excellent cable protection

R7728	32	50 - 300	74 - 324	54	125 - 300	3,00	7.224
R7838	42	50 - 300	77 - 327	64	125 - 350	3,80	7.236
R8840	56	75 - 462	111 - 499	84	150 - 500	4,50	7.248
R8840HD	56	75 - 462	129 - 516	84	150 - 300	4,50	7.260
R9850	80	75 - 462	125 - 513	108	200 - 1000	6,00	7.268
R9850HD	80	75 - 462	135 - 522	108	200 - 500	6,00	7.280

System E4/4 | E-Chains® and E-Tubes | **Assembling**



Remove crossbars at connection point. Slide side links into each other - Press together



Join the side links - join the second side link by pressing from the top



Join the side links together on the opposite side by applying pressure to the outer link



Assemble crossbars - Push down and snap in by using a screwdriver



Assemble clips (E-Chains® with crossbars every other link) - Push down and snap in



Assemble E-Tube lids/bottoms - Attach to the connector at an angle - Snap in

System E4/4 | E-Chains® and E-Tubes | **Separating**



Remove crossbars, clips, and lids on two adjacent chain links. Guide the screwdriver into the slot between side links and release it by levering it and separate the E-Chain®



E-Chains® | Opening



Remove crossbars - Insert screwdriver into the slot, push down, release by lever action



Remove clips - Insert screwdriver into the slot and push down, release by lever action

E-Tube | Opening



Remove lids/bottoms - Insert screwdriver into the slot, release by lever action

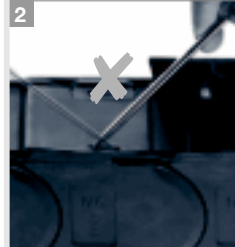

Release only **one side** to swivel the lid

Price index

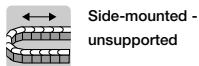

Side-mounted -
unsupported



ESD classification:
Electrically conductive ESD/ATEX
version upon request



High torsional
rigidity



Opening E-Chains: Remove crossbars and clips - Insert screwdriver into the slot, push down, release by lever action



Remove lids/bottoms (E-Tubes) - Insert screwdriver into the slot, release by lever action



When to use the Series 2828/2928/R7728:

- When high torsional or shearing forces are expected
- For side-mounted applications involving large unsupported lengths
- For long-term operation in very moist environments
- Also available as Rol E-Chain®



When not to use it:

- If a quieter version is required
- ▶ Series E4.32, page 7.34

- 1 High side-mount stability due to undercut
- 2 High torsional rigidity
- 3 Crossbars on E-Chains® are removable along both radii
- 4 Closed and open styles can be combined
- 5 Removable lids along inner radius
- 6 Hinged snap-open removable lids along outer radius of E-Tube
- 7 Lateral glide surfaces for side-mounted operation
- 8 Wide, rounded plastic crossbars - cable friendly
- 9 KMA mounting brackets with attachment points on all sides
- 10 Locking or pivoting mounting brackets available
- 11 E-Chain® also available with reverse bending radii



Rol E-Chain® Series 2828R/7728R available upon request

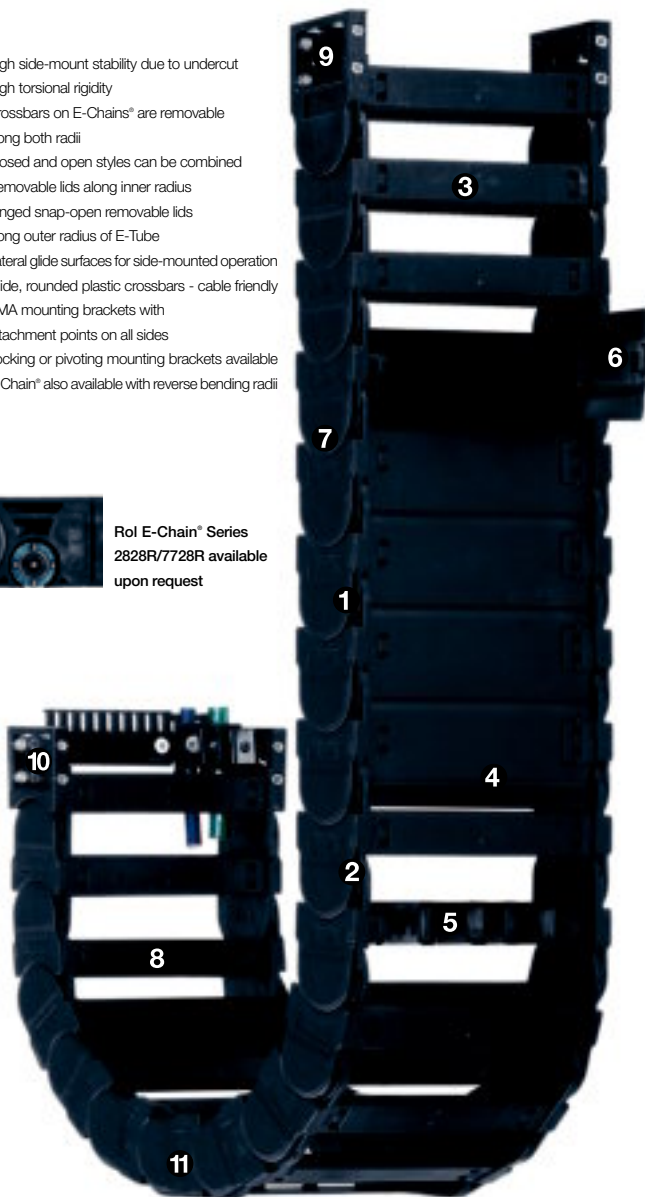

Order example complete E-Chain®

Please indicate chain-lengths or number of links Example: 3 m or 54 links

3 m 2828.30.300.0



E-Chain®

with 2 separators 282 assembled every 2nd link



Interior separation

1 set 28280.30.12C



Mounting bracket



Unsupported length

FL_G = with straight upper run

FL_B = with permitted sag

Further information ► **Design, page 1.12**

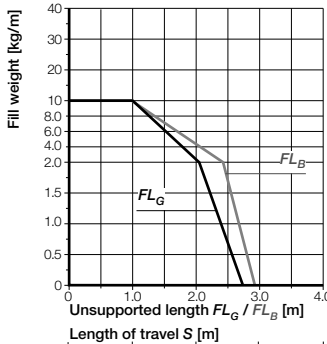
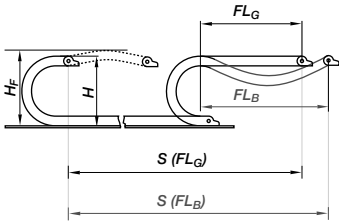

- S = Length of travel
 - R = Bending radius
 - H = Nominal clearance height
 - H_F = Required clearance height
 - H_{R1} = Trough inner height
 - D = Overlength E-Chain® radius in final position
 - $K = \pi \cdot R + \text{"safety"}$
 - D_2 = Over length - long travels, gliding
 - K_2 = *Further add-on
 - H_2 = *Mounting height
- *if the mounting bracket location is set lower

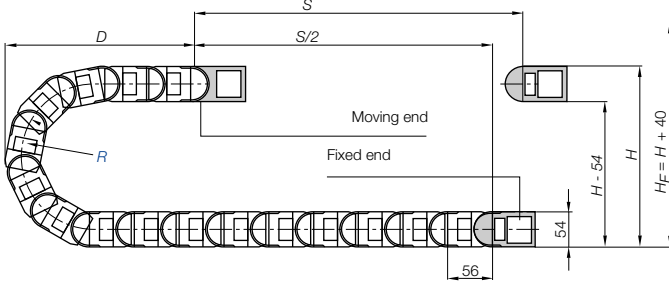

Pitch = 56 mm/link Links/m = 18 (1008 mm) Chain length = $S/2 + K$

R	063	075	100	125	150	175	200	220	250	300
H_{20}	180	205	255	305	355	405	455	495	555	655
D	130	150	175	200	225	250	275	295	325	375
K	340	380	465	550	620	700	780	850	940	1110
H_2	180	205	166	166	166	166	166	166	166	166
D_{20}	130	150	370	445	625	655	770	870	930	1240
K_2	340	380	616	784	1008	1064	1288	1456	1568	1960

Other installation methods

- Vertical, hanging ≤ 70 m
- Vertical, standing ≤ 5 m
- Side mounted, un supp. ≤ 2 m
- Rotary requires further calculation
- Unsupported length of upper run = upon request



Short travels - unsupported

Unsupported E-Chains® feature positive camber over short travels. This must be accounted for when specifying the clearance height H_F . Please consult igus® if space is particularly restricted.

The required clearance height:
 $H_F = H + 40$ mm
(with 2,0 kg/m fill weight)

Long travel lengths from 10 m to max. 200 m Chain length = $S/2 + K_2$

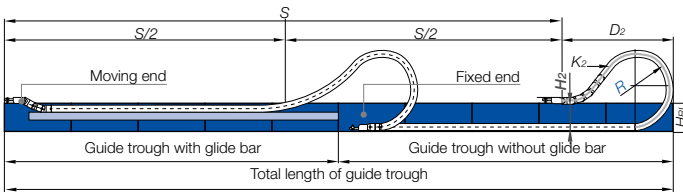

In case of travels between 4 and 10 m we recommend a longer unsupported length.



Gliding, long travel applications (max. 200 m)

In this case the E-Chain® upper run will be introduced in a guide trough on the lower run. We recommend to realize the engineering of such a plant by our technicians.

Speed / acceleration FL_G	max. 20 [m/s] / max. 200 [m/s]
Speed / acceleration FL_B	max. 3 [m/s] / max. 6 [m/s]
Gliding speed / acceleration (maximum)	max. 10 [m/s] / max. 50 [m/s]
Material - permitted temperature °C	igumid G / -40° up to +120° C
Flammability class, igumid G	VDE 0304 IIC UL94 HB

Technical Data



Details of material properties

► page 1.38



System E4/4
Inner height: 32 mm

Phone +49- (0) 22 03-96 49-800
Fax +49- (0) 22 03-96 49-222



► page 7.223

For support of the lower run - **Support Tray tool kit** available ► page 9.70

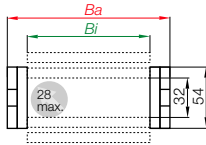

Part No. structure

2828. 30. 300. 0



Series 2828 - E-Chain® with crossbars every link

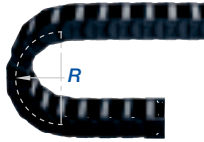

- Crossbars every link
- For rigid hydraulic hoses
- For applications particularly demanding
- Can be opened from two sides

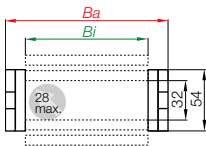

Part No. structure

2928. 30. 300. 0



Series 2928 - E-Chain® with crossbars every 2nd link

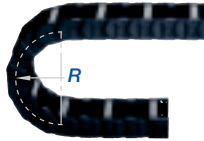

- Crossbars every 2nd link = Standard
- For nearly every situation
- Can be opened from two sides
- Easy assembly
- Stable
- Attractive price

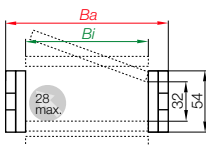

Part No. structure

7728. 30. 300. 0



Series R7728 - Fully enclosed E-Tube

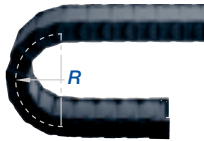

- Fully enclosed
- Excellent cable protection against dirt
- Protection against hot chips (up to 900°C)
- Lids along the entire inner radius are completely removable. Lids along the entire outer radius are single sided snap-open with a hinge on the other side to keep them attached to the chain or completely removable.



Rol instead of gliding: Rol E-Chain®

Special solution for long travels. 75% less drive power (gliding application) with igus® Rol E-Chain®.

Series 2828R - Order example 2828R.30.220.0

Further information: www.igus.de/en/role or phone: +49-0 22 03-96 49-800



Part No.	<i>Bi</i> [mm]	<i>Ba</i> [mm]	2828 [kg/m]	2928 [kg/m]	R7728 [kg/m]
2828/2928/7728.05... <input type="checkbox"/> .0*	50	74	≈ 1,73	≈ 1,64	≈ 2,63
2828/2928.06... <input type="checkbox"/> .0	68	92	≈ 1,79	≈ 1,67	-
2828/2928/7728.07... <input type="checkbox"/> .0	75	99	≈ 1,84	≈ 1,69	≈ 2,75
2828/2928.087... <input type="checkbox"/> .0	87	111	≈ 1,93	≈ 1,73	-
2828/2928/7728.10... <input type="checkbox"/> .0	100	124	≈ 2,02	≈ 1,78	≈ 2,83
2828/2928/7728.11... <input type="checkbox"/> .0	108	132	≈ 2,08	≈ 1,81	≈ 2,94
2828/2928.112... <input type="checkbox"/> .0	112	137	≈ 2,15	≈ 1,84	-
2828/2928/7728.12... <input type="checkbox"/> .0	125	149	≈ 2,20	≈ 1,87	≈ 3,03
2828/2928.137... <input type="checkbox"/> .0	137	162	≈ 2,29	≈ 1,91	-
2828/2928/7728.15... <input type="checkbox"/> .0	150	174	≈ 2,38	≈ 1,96	≈ 3,19
2828/2928.162... <input type="checkbox"/> .0	162	187	≈ 2,44	≈ 1,99	-
2828/2928/7728.17... <input type="checkbox"/> .0	168	192	≈ 2,51	≈ 2,02	≈ 3,39
2828/2928.18... <input type="checkbox"/> .0	175	199	≈ 2,56	≈ 2,05	-
2828/2928.187... <input type="checkbox"/> .0	187	212	≈ 2,65	≈ 2,09	-
2828/2928/7728.20... <input type="checkbox"/> .0	200	224	≈ 2,74	≈ 2,14	≈ 3,59
2828/2928.212... <input type="checkbox"/> .0	212	237	≈ 2,87	≈ 2,20	-
2828/2928.23... <input type="checkbox"/> .0	225	249	≈ 2,92	≈ 2,22	-
2828/2928.237... <input type="checkbox"/> .0	237	262	≈ 3,05	≈ 2,29	-
2828/2928/7728.25... <input type="checkbox"/> .0	250	274	≈ 3,10	≈ 2,32	≈ 4,04
2828/2928.262... <input type="checkbox"/> .0	262	286	≈ 3,19	≈ 2,36	-
2828/2928.28... <input type="checkbox"/> .0	275	299	≈ 3,28	≈ 2,41	-
2828/2928.29... <input type="checkbox"/> .0	287	312	≈ 3,37	≈ 2,45	-
2828/2928/7728.30... <input type="checkbox"/> .0	300	324	≈ 3,46	≈ 2,50	≈ 4,43
2828/2928.312... <input type="checkbox"/> .0	312	337	≈ 3,59	≈ 2,56	-
2828/2928.325... <input type="checkbox"/> .0	325	349	≈ 3,68	≈ 2,60	-
2828/2928.337... <input type="checkbox"/> .0	337	362	≈ 3,77	≈ 2,65	-
2828/2928.350... <input type="checkbox"/> .0	350	374	≈ 3,86	≈ 2,69	-
2828/2928.362... <input type="checkbox"/> .0	362	387	≈ 3,95	≈ 2,74	-
2828/2928.375... <input type="checkbox"/> .0	375	399	≈ 4,04	≈ 2,79	-
2828/2928.387... <input type="checkbox"/> .0	387	412	≈ 4,11	≈ 2,82	-
2828/2928.400... <input type="checkbox"/> .0	400	424	≈ 4,18	≈ 2,86	-

Available bending radii **not available for R7728 · *Removable lid only, no hinged option

R [mm] 063** 075** 100** 125 150 175 200 220 250 300

Supplement Part No. with required radius. Example: 2828.30.300.0

0 = standard color, other colors ▶ page 1.39 · Pitch = 56 mm/link · Links/m = 18

Hot Chips up to 850°C

E-Tubes that repel hot chips, up to 850°C. Some applications, depending on amount and size of the chips, can burn or melt the surface. That is no longer the case with the igus® "igumid HT" material. Order example:

Full E-Tube made of HT:

7728.30.150.0.HT

Lids made of HT:
7728.30.HTE.150.0

*for long travels. Upon request

Further Information:
www.igus.de/en/HT

Delivery time
up to 4 weeks!



Extender crossbar for large diameter hoses ▶ page 7.230

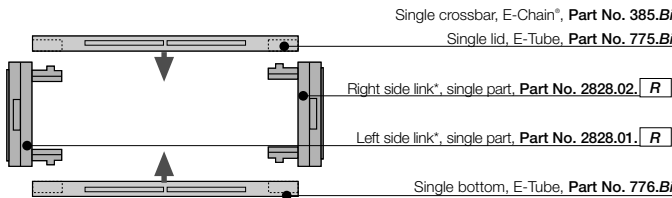

Part No. E-Chain® - links, single parts

*View from the fixed point of the E-Chain®/E-Tube

System E4/4
Inner height: 32 mm

Phone +49- (0) 22 03-96 49-800
Fax +49- (0) 22 03-96 49-222



▶ page 7.223



Vertical separators are used if a vertical subdivision is required. In the standard configuration, a separator is mounted at every second link. **Note:** Observe a lateral spacing of at least 25 mm (E-Tube)

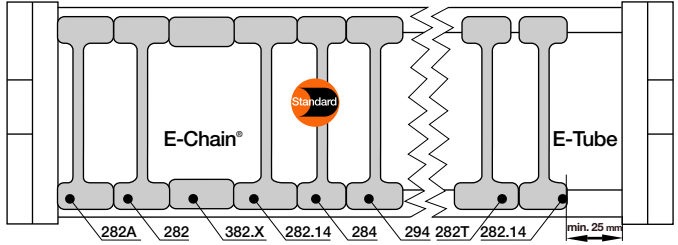

Vertical separator
281



Vertical separator
281T



Vertical separator
281.14



Vertical separator
283



Spacer
381.XX



Locking separator
293



Asymmetric
separator 281A

Vertical separator for E-Chains*	2,5
unassembled	281
assembled	282



Vertical separator for E-Tubes	2,5
unassembled	281T
assembled	282T



Vertical separator for E-Chains*/E-Tubes	2,5
unassembled	281.14
assembled	282.14



Vertical separator for E-Chains*	2,5
unassembled	283
assembled	284



Spacer*	2,5
for E-Chains*	XX
unassembled	381.XX
assembled	382.XX



Locking separator for E-Chains*	2,5
unassembled	293
assembled	294



Asymmetric separator for E-Chains*	2,5
unassembled	281A
assembled	282A



*For side-mounted applications

Option 1: Vertical separators and spacers

● **Standard separator 281 for E-Chains®** offers safe stability due to its broad foot design, also when used with thick cables or hoses. If the distance needed between separators is greater than this separator's dimension, we offer the **Vertical separator 281.14**.

● **Standard separator 281 for E-Chains®** offers safe stability due to its broad foot design, also when used with thick cables or hoses. If the distance needed between separators is greater than this separator's dimension, we offer the **Vertical separator 281.14**.

● **Vertical separator 283 with a narrow foot for E-Chains®** with applications where a large number of small cables need to be individually separated.

● Separators (e.g. "side mounted") for E-Chains® can be fixed in their position with **spacers 381.XX**. The available inner height will be reduced by 2 mm, per spacer and side. To avoid this, the parts can be assembled on outside of the crossbar (not for long travels) **XX = width of the spacer** (available 10, 15, 20).

Additionally

● **Locking separator 293 for E-Chains®** - with increased retention force for applications exposed to very high humidity or extreme loads. The extra retention force is achieved by asymmetric claws for the crossbar. Ensure proper alignment (not for E-Tubes).

● **Asymmetric separator 281A for E-Chains®** (not for E-Tubes) with an 12-mm base, for combinations between spacers of different widths and vertical separators in side-mounted applications, for instance.

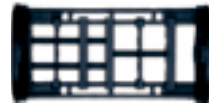
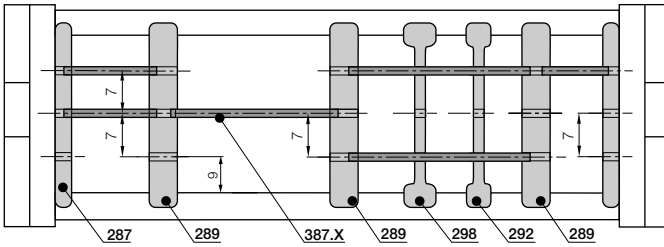

For use with many cables of differing diameters. E-Chains[®] and E-Tubes can be subdivided both vertically and horizontally. The shelves can be arranged elevator-shifted with different bottoms

Option 2: Shelves

● Side plates 286, middle plates 288 and shelves 386.X form the basic pattern of a shelf system. Shelves of various widths can be arranged at 3 different heights (in 7 mm increments).

● For special applications: Vertical separator with injection moulded shelf 281.S.57 (57,5 mm) or 281.S.45 (45 mm)

● Slotted separators 291 (not for E-Tubes), are used for very fine subdivisions. However, they cannot be retrofitted into an existing separation system without dismantling the interior separators first.

● The unilateral open slotted separator 297 can be retrofitted into an existing interior separation system without a need for dismantling the interior separators. During an installation of open slotted separators, the top and bottom notches cannot be occupied by shelves.

Side plate for E-Chains [®] /E-Tubes	
unassembled	286
assembled	287

Middle plate for E-Chains [®] /E-Tubes	
unassembled	288
assembled	289

Vertical separator for E-Chains [®] /E-Tubes	
unassembled	281.S.57
assembled	282.S.57

Vertical separator for E-Chains [®] /E-Tubes	
unassembled	281.S.45
assembled	282.S.45

Slotted separator for E-Chains [®]	
unassembled	291
assembled	292

Open slotted separator for E-Chains [®] /E-Tubes	
unassembled	297
assembled	298

Width X [mm]	Part No. unassembled	Part No. assembled
018	386.18	387.18
023	386.23	387.23
025	386.25	387.25
028	386.28	387.28
033	386.33	387.33
043	386.43	387.43
050	386.50	387.50
054	386.54	387.54
062	386.62	387.62
075	386.75	387.75

Width X [mm]	Part No. unassembled	Part No. assembled
087	386.87	387.87
100	386.100	387.100
108	386.108	387.108
125	386.125	387.125
150	386.150	387.150
175	386.175	387.175
200	386.200	387.200
208	386.208	387.208
225	386.225	387.225



Side plate
286



Middle plate
288

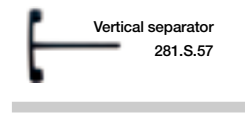

Vertical separator
281.S.57

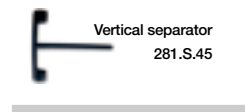

Vertical separator
281.S.45

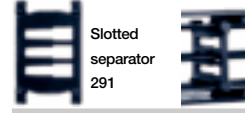

Slotted
separator
291



Open slotted
separator
297

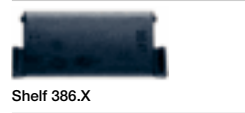

Shelf 386.X

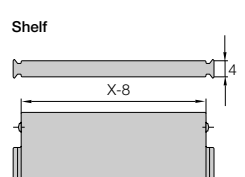

Shelf

System E4/4
Inner height: 32 mm

Phone +49- (0) 22 03-96 49-800
Fax +49- (0) 22 03-96 49-222





Extension links - for extremely wide E-Chains® up to 3,0 m

- For applications in which particularly high fill weights necessitate extremely wide E-Chains® (up to 3000 mm)
- The extension link design allows virtually limitless side-by-side attachment of chains
- The unsupported length of a chain can be increased when additional loads are required
- Extension links can be used with E-Chains®, E-Tubes or as a combination of both
- They are suitable for unsupported and gliding applications in a guide trough
- E-Chains® with extension links are attached with KMA or steel mounting brackets



Part No. structure
2828.10 /20 /10. [200].0
2828.Bi1/Bi2/Bi3. [R].0

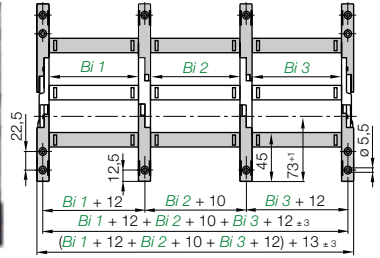
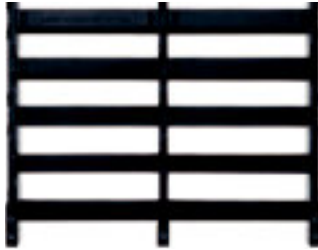

Consult igus® for your extender crossbar applications. We are happy to assist you with your design layout

Extender crossbars - careful guide of hoses applications

- Suitable for hoses with a maximum outer diameter of 105 mm
- Gliding operation with crossbars assembled along the outer radius and a special guide trough
- Gliding operation not guaranteed with crossbars assembled along the inner radius
- The extender crossbar can either be attached to the side links directly or can be used in combination with two stranded snap-open crossbars

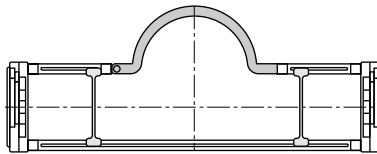

385.15RHD115 round extender crossbar combined with snap-open crossbars

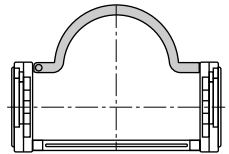

385.18RD115 round strap assembled directly on the side section

Part No.	Max Ø [mm] hose	Form	Installation side link	Combination with snap-open crossb.
385.15.RHD115	105	○	-	+
385.18.RD115	105	○	+	-

○ = round + = yes / - = no

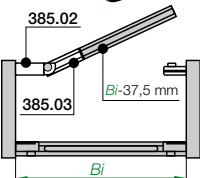

Hinged crossbars

- Typically E-Chain® crossbars are completely removable. In cases where the snap-open crossbars have to remain at the open link of the E-Chain®, a hinged design has been developed
- Length: 37,5 mm **Part No. 385.02** / snap-open crossbar (shortened): Bi-37,5 mm **Part No. 385.03**
- Please consult igus® for design assistance

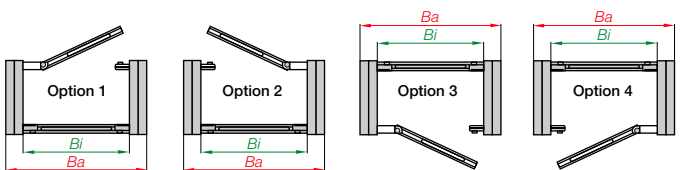

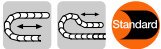

The Standard - Option KMA* - pivoting

- Recommended for unsupported and gliding applications
- Confined installation conditions
- Option - integrated C-profile strain relief device with Chainfix clip or strain relief tiwrap plates
- Corrosion resistant
- Universal mountable with attachment capability on all sides

*KMA = Polymer Metal Mounting Bracket

Moving end
28280/77280...1

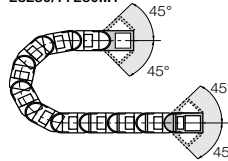

Fixed end
28280/77280...2



The attachment variants arising automatically by the choice of the KMA mounting bracket

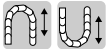
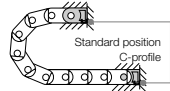

Option KMA - locking

- Recommended for vertical hanging / standing applications

Additionally:

- Universal mountable
- C-profile option
- Corrosion resistant
- Locked connections
- At very high acceleration

Moving end
29280/78280...1

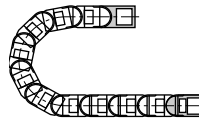

Fixed end
29280/78280...2



The attachment variants arising automatically by the choice of the KMA mounting bracket

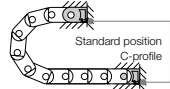

Fixed end

28280/77280...2 (pivoting)
29280/78280...2 (locking)

Moving end

(pivoting) 28280/77280...1
(locking) 29280/78280...1

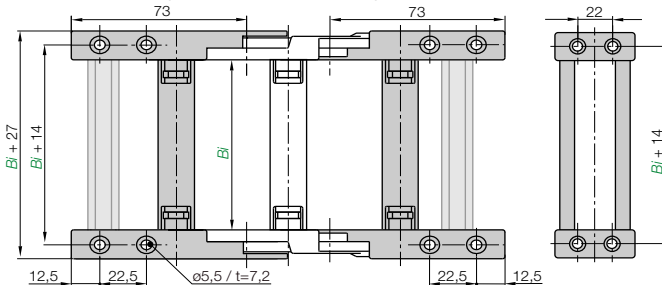

Dimensions and order configurations

Part No. structure (pivoting)

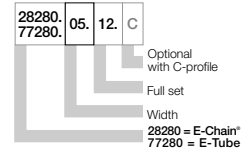

Part No. structure (locking)

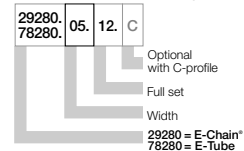

Width index	Part No. full set		C-profile option [mm]		Width index	Part No. full set		C-profile option [mm]	
	pivoting	locking	C-profile	option [mm]		pivoting	locking	option	option [mm]
.05.	▶ 28280/77280	29280/78280	.05.12.C	50	.23.	▶ 28280	29280	.23.12.C	225
.06.	▶ 28280	29280	.06.12.C	68	.237.	▶ 28280	29280	.237.12.C	237
.07.	▶ 28280/77280	29280/78280	.07.12.C	75	.25.	▶ 28280/77280	29280/78280	.25.12.C	250
.087.	▶ 28280	29280	.087.12.C	87	.262.	▶ 28280	29280	.262.12.C	262
.10.	▶ 28280/77280	29280/78280	.10.12.C	100	.28.	▶ 28280	29280	.28.12.C	275
.11.	▶ 28280/77280	29280/78280	.11.12.C	108	.29.	▶ 28280	29280	.29.12.C	287
.112.	▶ 28280	29280	.112.12.C	112	.30.	▶ 28280/77280	29280/78280	.30.12.C	300
.12.	▶ 28280/77280	29280/78280	.12.12.C	125	.312.	▶ 28280	29280	.312.12.C	312
.137.	▶ 28280	29280	.137.12.C	137	.325.	▶ 28280	29280	.325.12.C	325
.15.	▶ 28280/77280	29280/78280	.15.12.C	150	.337.	▶ 28280	29280	.337.12.C	337
.162.	▶ 28280	29280	.162.12.C	162	.350.	▶ 28280	29280	.350.12.C	350
.17.	▶ 28280/77280	29280/78280	.17.12.C	168	.362.	▶ 28280	29280	.362.12.C	362
.18.	▶ 28280	29280	.18.12.C	175	.375.	▶ 28280	29280	.375.12.C	375
.187.	▶ 28280	29280	.187.12.C	187	.387.	▶ 28280	29280	.387.12.C	387
.20.	▶ 28280/77280	29280/78280	.20.12.C	200	.400.	▶ 28280	29280	.400.12.C	400
.212.	▶ 28280	29280	.212.12.C	212					

Full set, for both ends:

28280.[05].[12]

Single-part order:

28280.[05].[1]

Mounting bracket moving end

28280.[05].[2]

Mounting bracket fixed end

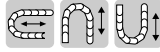

Option steel - pivoting

- For pivoting connections
- One part (two-piece) for all chain widths
- Electrically conductive

Moving end
28280.1

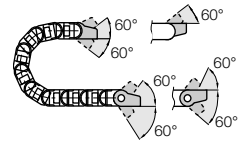

Fixed end
28280.2

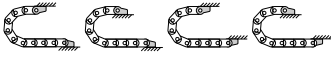

Possible installation conditions -

Further installation angles ► installation sketch

Phone +49- (0) 22 03-96 49-800
Fax +49- (0) 22 03-96 49-222

igus® GmbH
51147 Cologne

Internet: www.igus.eu
E-mail: info@igus.de

Moving end
28280.1

Fixed end
28280.2

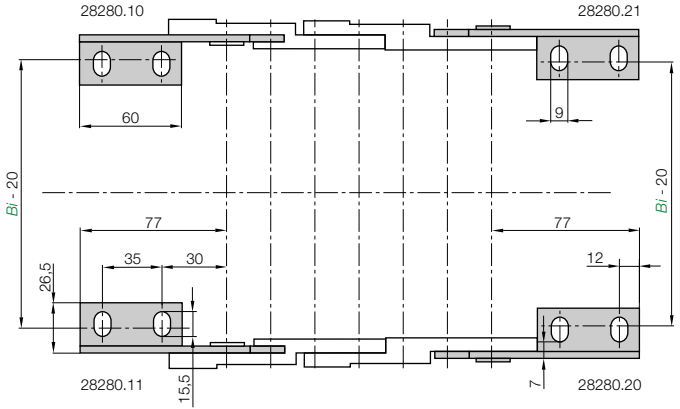

For	Part No.	Bi	For	Part No.	Bi
E-Chain®	full set	[mm]	E-Chain®	full set	[mm]
2828-2928-7728.05 ►	28280.12	50	2828-2928.23 ►	28280.12	225
2828-2928.06 ►	28280.12	68	2828-2928.237 ►	28280.12	237
2828-2928-7728.07 ►	28280.12	75	2828-2928-7728.25 ►	28280.12	250
2828-2928.087 ►	28280.12	87	2828-2928.262 ►	28280.12	262
2828-2928-7728.10 ►	28280.12	100	2828-2928.28 ►	28280.12	275
2828-2928-7728.11 ►	28280.12	108	2828-2928.29 ►	28280.12	287
2828-2928.112 ►	28280.12	112	2828-2928-7728.30 ►	28280.12	300
2828-2928-7728.12 ►	28280.12	125	2828-2928.312 ►	28280.12	312
2828-2928.137 ►	28280.12	137	2828-2928.325 ►	28280.12	325
2828-2928-7728.15 ►	28280.12	150	2828-2928.337 ►	28280.12	337
2828-2928.162 ►	28280.12	162	2828-2928.350 ►	28280.12	350
2828-2928-7728.17 ►	28280.12	168	2828-2928.362 ►	28280.12	362
2828-2928.18 ►	28280.12	175	2828-2928.375 ►	28280.12	375
2828-2928.187 ►	28280.12	187	2828-2928.387 ►	28280.12	387
2828-2928-7728.20 ►	28280.12	200	2828-2928.400 ►	28280.12	400
2828-2928.212 ►	28280.12	212			

28280.12 Full set, 4 parts
2 with pin / 2 with bore

Single-part order:

- 28280.1 Mounting bracket moving end, 1 part left / right
- 28280.2 Mounting bracket fixed end, 1 part left / right

Other strain relief elements
► chapter 10

Chainfix clamps for the C-profile

Part No. single clamps		Part No. double clamps		Part No. triple clamps		Cable
steel	stainless steel	steel	stainless steel	steel	stainless steel	ø [mm]
CFX12.1	CFX12.1.E	CFX12.2	CFX12.2.E	CFX12.3	-	06 - 12
CFX14.1	CFX14.1.E	CFX14.2	CFX14.2.E	CFX14.3	-	12 - 14
CFX16.1	CFX16.1.E	CFX16.2	CFX16.2.E	CFX16.3	-	14 - 16
CFX18.1	CFX18.1.E	CFX18.2	CFX18.2.E	CFX18.3	-	16 - 18
CFX20.1	CFX20.1.E	CFX20.2	CFX20.2.E	CFX20.3	-	18 - 20
CFX22.1	CFX22.1.E	CFX22.2	CFX22.2.E	CFX22.3	-	20 - 22
CFX26.1	CFX26.1.E	CFX26.2	CFX26.2.E	-	-	22 - 26
CFX30.1	CFX30.1.E	CFX30.2	CFX30.2.E	-	-	26 - 30
CFX34.1	CFX34.1.E	CFX34.2	CFX34.2.E	-	-	30 - 34
CFX38.1	CFX38.1.E	-	-	-	-	34 - 38
CFX42.1	CFX42.1.E	-	-	-	-	38 - 42

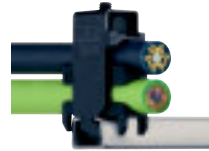

igus® Chainfix steel clamps and Chainfix stainless-steel clamps - max. pull forces, adjustable with hexagon socket. Available as single, double or triple clamps. **Details ▶ chapter 10**

System E4/4
Inner height: 32 mm

Cable ø [mm]	Part No. clamp	Part No. bottom part
04 - 08	CFC-08-M	CFC-08-C
08 - 12	CFC-12-M	CFC-12-C
12 - 16	CFC-16-M	CFC-16-C
16 - 20	CFC-20-M	CFC-20-C
20 - 24	CFC-24-M	CFC-24-C

Chainfix Clip - Modular snap-on strain relief device for C-profile

Available for all igus® E-ChainSystems® with C-profiles and also suitable for assembly in the KMA mounting brackets and clip-on strain relief for crossbars. High pull forces, plug-in modular snap-on strain relief device. **Details ▶ chapter 10**



Part No.	ø max. conduit [mm]	Width [mm]
CFN.20	20	10,8
CFN.30.52	30	16,8
CFN.20.N35	20	20,0

Chainfix Nugget for the C-Profile

Strain relief for the fixation of cables up to a diameter of Ø 30 mm. Easy to assemble, without any screws and tools. Easy strain relief due to fixation with pre-hressed cable strap, very small space requirement. **Details ▶ chapter 10**



Part No.	Width of strain relief [mm]	Number of teeth
3050.ZC	50	5
3075.ZC	75	7

Chainfix tiwrap plates with clip-on connection for the C-profile

Can be plugged into the KMA C-profile. Easy to assemble without any screws. Easily solvable with screwdriver nevertheless safe stop. For all E-Chains® with KMA and integrated C-profile. **Details ▶ chapter 10**

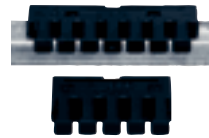

Tiewrap plate	No. of teeth n	Dim. C [mm]	Dim. B [mm]	Center bore
3050.ZB	5	50	30	-
3075.ZB	7	75	55	-
3100.ZB	10	100	80	-
3115.ZB	11	115	95	-
3125.ZB	12	125	105	-
3150.ZB	15	150	130	-
3175.ZB	17	175	155	-
3200.ZB	20	200	180	+
3225.ZB	22	225	205	+
3250.ZB	25	250	230	+

(- = no / + = yes)

Tiewrap plate as individual part

As individual component screwed on KMA. Can be plugged in the mounting brackets. **Details ▶ chapter 10**

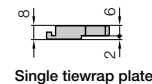
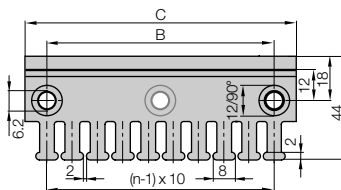

Single tiewrap plate

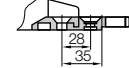

Shown assembled



▶ page 7.223

- Ba** = Outer width E-Chains® / E-Tube
 - Bi** = Inner width E-Chains® / E-Tube
 - ha** = Outer height E-Chains® / E-Tube
 - H_{Ri}** = Inner trough height
 - H_{Ra}** = Outer trough height
 - B_{Ri}** = Inner trough width ▶ depends on dim. Ba
 - B_{Ra}** = Outer trough width
 - n_{Mon}** = Number of installation sets (left/right)
 - n_{Ri}** = Number of troughs sets (left/right)
- $H_{Ri} \geq 2 \cdot ha$
 $B_{Ri} \geq Ba + 4$
- = Guide trough set
 - = Glide bar
 - = Installation set "Basic"
 - = C-profile

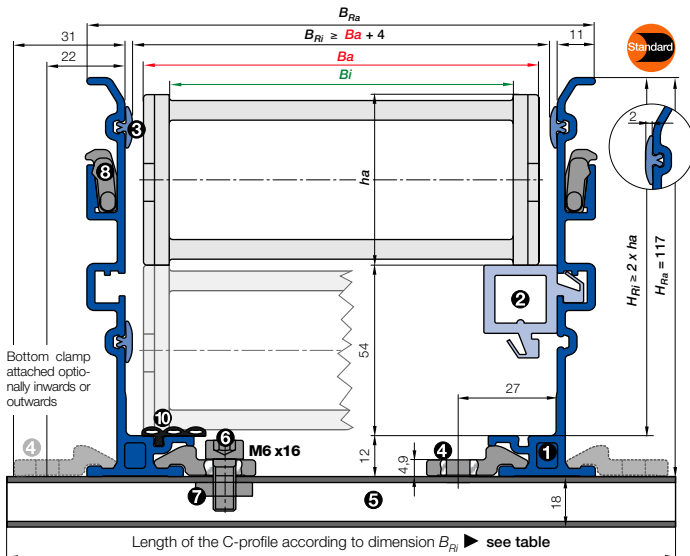

Phone+49- (0) 22 03-96 49-800
Fax +49- (0) 22 03-96 49-222

Installation set "Basic" with C-profile

Bottom Clamp attached optionally inwards or outwards

2828.05.200.0 ▶ Order example

B _{Ri} attached [mm]	Part No.	
	inwards	outwards
.05	78 960.30.125	960.30.175
.06	96 960.30.150	960.30.200
.07	103 960.30.150	960.30.200
.087	115 960.30.175	960.30.225
.10	128 960.30.175	960.30.225
.11	136 960.30.200	960.30.225
.112	141 960.30.200	960.30.250
.12	153 960.30.200	960.30.250
.137	166 960.30.225	960.30.275
.15	178 960.30.225	960.30.275
.162	191 960.30.250	960.30.300
.17	196 960.30.250	960.30.300
.18	203 960.30.250	960.30.300
.187	216 960.30.275	960.30.325
.20	228 960.30.275	960.30.325
.212	241 960.30.300	960.30.350
.23	253 960.30.300	960.30.350
.237	266 960.30.325	960.30.375
.25	278 960.30.325	960.30.375
.262	291 960.30.350	960.30.400
.28	303 960.30.350	960.30.400
.29	316 960.30.375	960.30.425
.30	328 960.30.375	960.30.425
.312	341 960.30.400	960.30.450
.325	353 960.30.400	960.30.450
.337	366 960.30.425	960.30.475
.350	378 960.30.425	960.30.475
.362	391 960.30.450	960.30.500
.375	403 960.30.450	960.30.500
.387	416 960.30.475	960.30.525
.400	428 960.30.475	960.30.525

igus® GmbH
51147 Cologne

Internet: www.igus.eu
E-mail: info@igus.de



- **Components, trough "Basic":** ① Trough side parts, aluminum, 2 m ② Glide bar, plastic, 2 m ③ Glide strips, plastic, 2 m (without glide strips on request) ⑩ Optional: Silencer profile, rubber
- **Components, installation set "Basic":** ④ Bottom clamp, aluminum ⑤ C-profile, steel galvanized ⑥ Screw M6 x 16 ⑦ Sliding nut M6 ⑧ Interface connector, plastic



Order example: Length of travel 30 m - Center mounted for Series 2828.30.300.0 with B_{Ri} = 328

- Guide trough set (set of 2 trough side parts, incl. glide strips) **without** glide bar
Order text: 16 m guide trough without glide bar (8 x 2 m sections) Part No. **972.30.SL**
- Guide trough set (set of 2 trough side parts, incl. glide strips) **with** glide bar
Order text: 16 m guide trough with glide bar (8 x 2 m sections) Part No. **972.31.SL**
- Installation set "Basic" complete (guide trough-sets + 1)
Order text: 17 installation sets "Basic" Part No. **960.30.375**
- Module for the fixed end
Order text: 1 set Part No. **972.80**
- Option:** For an additional noise dampening with silencer profile, please add Index A - Example: Part No. **972.30.SLA**

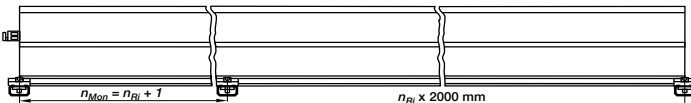

Principle sketch: Number of installation sets to be installed = Number of trough sections + 1

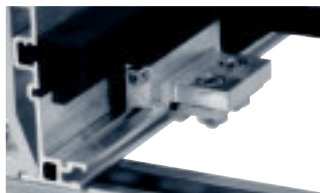

A quick fix for mounting the stationary end of an E-Chain®

With this module for the fixed end, fast and easy mounting onto the Aluminum "SuperTrough" is now possible without any drilling. Fast mounting of the E-Chain® by clamping onto the aluminum trough

- Quick relocation of the stationary end
- No drilling necessary ▶ page 9.16



High unsupported lengths and perfect suitability für circular movements (RBR-versions) are some features for the E4/4-System

System E4/4
Inner height: 32 mm

Phone +49- (0) 22 03-96 49-800
Fax +49- (0) 22 03-96 49-222



► Chapter 9



► page 7.223

Price index



Series 3838

Series 3938

Series R7838



Side-mounted -
unsupported



ESD classification:
Electrically conductive ESD/ATEX
version upon request



High torsional
rigidity



Opening E-Chains: Remove crossbars and clips - Insert screwdriver into the slot, push down, release by lever action



Remove lids/bottoms (E-Tubes) - Insert screwdriver into the slot, release by lever action



When to use the Series 3838/3938/R7838:

- When high torsional or shearing forces are expected
- For side-mounted applications involving large unsupported lengths
- For long-term operation in very moist environments
- Also available as Rol E-Chain®



When not to use it:

- If a quieter version is required
▶ Series E4.42, page 7.48

- 1 High side-mount stability due to undercut
- 2 High torsional rigidity
- 3 Closed and open styles can be combined
- 4 Hinged snap-open removable lids along outer radius of E-Tube
- 5 Removable lids along inner radius
- 6 Crossbars on E-Chains® are removable along both radii
- 7 Lateral glide surfaces for side-mounted operation
- 8 Wide, rounded plastic crossbars - cable friendly
- 9 KMA mounting brackets with attachment points on all sides
- 10 Locking or pivoting mounting brackets available
- 11 E-Chain® also available with reverse bending radii



Rol E-Chain® Series
3838R/7838R available
upon request



Order example complete E-Chain®

Please indicate chain-lengths or number of links Example: 4 m or 60 links

4 m 3838.30.300.0



E-Chain®

with 2 separators 382 assembled every 2nd link



Interior separation

1 set 38380.30.12C



Mounting bracket



Unsupported length

FL_G = with straight upper run

FL_B = with permitted sag

Further information ► Design, page 1.12

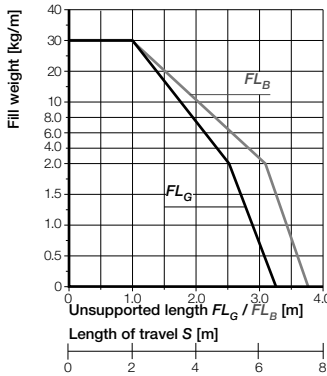
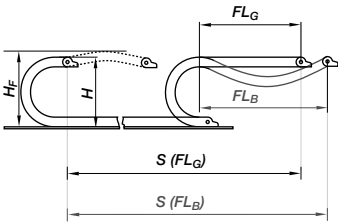

- S = Length of travel
 - R = Bending radius
 - H = Nominal clearance height
 - H_F = Required clearance height
 - H_{Ri} = Trough inner height
 - D = Overlength E-Chain" radius in final position
 - $K = \pi \cdot R + \text{"safety"}$
 - D_2 = Over length - long travels, gliding
 - K_2 = "Further add-on
 - H_2 = "Mounting height
- *if the mounting bracket location is set lower

Other installation methods

- Vertical, hanging ≤ 100 m
- Vertical, standing ≤ 6 m
- Side mounted, un supp. $\leq 2,5$ m
- Rotary requires further calculation
- Unsupported length of upper run = upon request

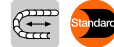

Short travels - unsupported

Unsupported E-Chains" feature positive camber over short travels. This must be accounted for when specifying the clearance height H_F . Please consult igus" if space is particularly restricted.

The required clearance height:

$$H_F = H + 40 \text{ mm}$$

(with 2,0 kg/m fill weight)

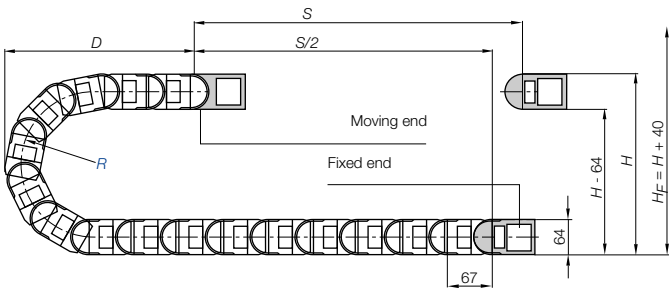

Pitch = 67 mm/link Links/m = 15 (1005 mm) Chain length = $S/2 + K$

R	075	100	115	125	150	170	200	215	250	300	350
$H_{2,25}$	215	265	295	315	365	405	465	495	565	665	765
D	174	199	214	224	249	269	299	314	349	399	449
K	370	450	500	530	610	670	765	810	920	1080	1235
H_2	215	265	186	186	186	186	186	186	186	186	186
$D_{2,25}$	174	199	435	475	570	690	780	865	1010	1150	1500
K_2	370	450	737	804	1005	1139	1340	1407	1675	1943	2412

Long travel lengths from 10 m to max. 280 m Chain length = $S/2 + K_2$

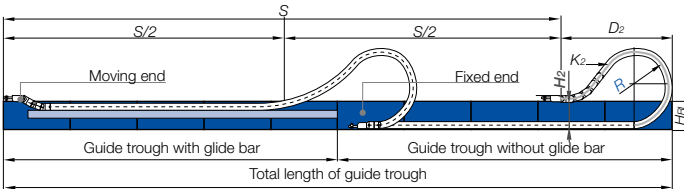

In case of travels between 4 and 10 m we recommend a longer unsupported length.



Gliding, long travel applications (max. 280 m)

In this case the E-Chain" upper run will be introduced in a guide trough on the lower run. We recommend to realize the engineering of such a plant by our technicians.

Technical Data

Speed / acceleration FL_G	max. 20 [m/s] / max. 200 [m/s]
Speed / acceleration FL_B	max. 3 [m/s] / max. 6 [m/s]
Gliding speed / acceleration (maximum)	max. 10 [m/s] / max. 50 [m/s]
Material - permitted temperature °C	igumid G / -40° up to +120° C
Flammability class, igumid G	VDE 0304 IIC UL94 HB



Details of material properties

► page 1.38

42

System E4/4
Inner height: 42 mm

Phone +49- (0) 22 03-96 49-800
Fax +49- (0) 22 03-96 49-222



► page 7.223

For support of the lower run - Support Tray tool kit available ► page 9.70

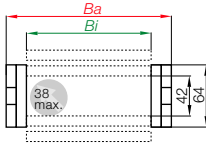

Part No. structure

3838. 400. 300. 0



Series 3838 - E-Chain® with crossbars every link

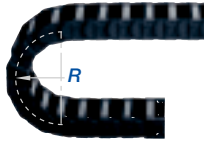

- Crossbars every link
- For rigid hydraulic hoses
- For applications particularly demanding
- Can be opened from two sides

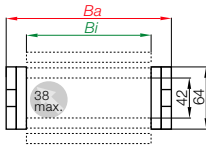

Part No. structure

3938. 400. 300. 0



Series 3938 - E-Chain® with crossbars every 2nd link

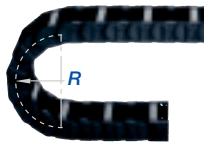

- Crossbars every 2nd link = Standard
- For nearly every situation
- Can be opened from two sides
- Easy assembly
- Stable
- Attractive price

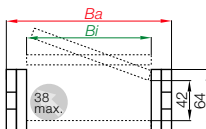

Part No. structure

7838. 25. 300. 0



Series R7838 - Fully enclosed E-Tube

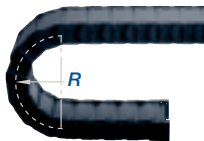

- Fully enclosed
- Excellent cable protection against dirt
- Protection against hot chips (up to 900°C)
- Lids along the entire inner radius are completely removable. Lids along the entire outer radius are single sided snap-open with a hinge on the other side to keep them attached to the chain or completely removable.



Rol instead of gliding: Rol E-Chain®

Special solution for long travels. 75% less drive power (gliding application) with igus® Rol E-Chain®.

Series 3838R - Order example - 3838R.30.250.0

Further information: www.igus.de/en/role
or phone: +49-0 22 03-96 49-800



Part No.		Bi [mm]	Ba [mm]	3838 [kg/m]	3938 [kg/m]	R7838 [kg/m]
3838/3938/7838.05.	□.0*	50	77	≈ 2,06	≈ 1,98	≈ 2,25
3838/3938.06.	□.0	68	95	≈ 2,09	≈ 1,99	-
3838/3938/7838.07.	□.0	75	102	≈ 2,12	≈ 2,01	≈ 2,38
3838/3938.087.	□.0	87	115	≈ 2,18	≈ 2,04	-
3838/3938/7838.10.	□.0	100	127	≈ 2,25	≈ 2,08	≈ 2,60
3838/3938/7838.11.	□.0	108	135	≈ 2,30	≈ 2,10	≈ 2,65
3838/3938.112.	□.0	112	140	≈ 2,30	≈ 2,10	-
3838/3938/7838.12.	□.0	125	152	≈ 2,40	≈ 2,15	≈ 2,81
3838/3938.137.	□.0	137	165	≈ 2,44	≈ 2,17	-
3838/3938/7838.15.	□.0	150	177	≈ 2,53	≈ 2,21	≈ 3,07
3838/3938.162.	□.0	162	190	≈ 2,55	≈ 2,22	-
3838/3938/7838.17.	□.0	168	195	≈ 2,62	≈ 2,26	≈ 3,24
3838/3938.18.	□.0	175	202	≈ 2,62	≈ 2,26	-
3838/3938.187.	□.0	187	215	≈ 2,69	≈ 2,30	-
3838/3938/7838.20.	□.0	200	227	≈ 2,77	≈ 2,33	≈ 3,53
3838/3938.212.	□.0	212	240	≈ 2,84	≈ 2,37	-
3838/3938.23.	□.0	225	252	≈ 2,92	≈ 2,41	-
3838/3938.237.	□.0	237	265	≈ 2,96	≈ 2,43	-
3838/3938/7838.25.	□.0	250	277	≈ 3,05	≈ 2,47	≈ 4,33
3838/3938.262.	□.0	262	290	≈ 3,06	≈ 2,48	-
3838/3938.28.	□.0	275	302	≈ 3,17	≈ 2,53	-
3838/3938.29.	□.0	287	315	≈ 3,19	≈ 2,54	-
3838/3938/7838.30.	□.0	300	327	≈ 3,32	≈ 2,61	≈ 4,89
3838/3938.312.	□.0	312	340	≈ 3,34	≈ 2,62	-
3838/3938.325.	□.0	325	352	≈ 3,41	≈ 2,66	-
3838/3938.337.	□.0	337	365	≈ 3,46	≈ 2,68	-
3838/3938.350.	□.0	350	377	≈ 3,68	≈ 2,79	-
3838/3938.362.	□.0	362	390	≈ 3,74	≈ 2,82	-
3838/3938.375.	□.0	375	402	≈ 3,79	≈ 2,84	-
3838/3938.387.	□.0	387	415	≈ 3,85	≈ 2,87	-
3838/3938.400.	□.0	400	427	≈ 3,90	≈ 2,90	-

Hot Chips up to 850°C

E-Tubes that repel hot chips, up to 850°C. Some applications, depending on amount and size of the chips, can burn or melt the surface. That is no longer the case with the igus® "igumid HT" material. Order example: Full E-Tube made of HT: **7838.30.150.0.HT**
Lids made of HT: **7838.30.HTE.150.0**

*for long travels. Upon request
Further Information: www.igus.de/en/HT
Delivery time up to 4 weeks!

System E4/4
Inner height: 42 mm

Phone +49- (0) 22 03-96 49-800
Fax +49- (0) 22 03-96 49-222

Available bending radii

R [mm] **075*** **100*** **115*** 125 150 170 200 215 250 300 350

Supplement Part No. with required radius. Example: 3838.400.300.0

0 = standard color, other colors ▶ page 1.39 · Pitch = 67 mm/link - Links/m = 15

*Removable lid only, no hinged option · **not available for R7838



Extender crossbar for large diameter hoses ▶ page 7.242

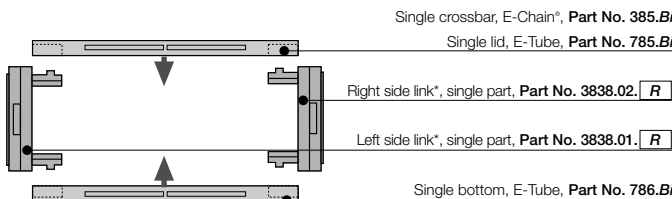

Part No. E-Chain® - links, single parts

*View from the fixed point of the E-Chain®/E-Tube



Vertical separators are used if a vertical subdivision is required. In the standard configuration, a separator is mounted at every second link. **Note:** Observe a lateral spacing of at least 25 mm (E-Tube)!

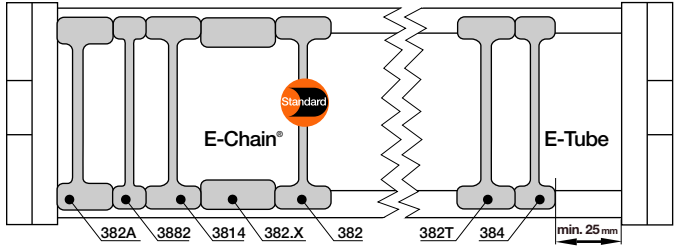

Vertical separator
381



Vertical separator
with a narrow base
3881



Vertical separator
381T



Spacer
381.XX



Locking separator
3804



Locking separator
383



Asymmetric
separator 381A

Vertical separator for E-Chains*	
unassembled	381
assembled	382



Vertical separator* for E-Chains*	
unassembled	3881
assembled	3882



Vertical separator for E-Tubes	
unassembled	381T
assembled	382T



Spacer*	
for E-Chains*	
unassembled	381.XX
assembled	382.XX



Locking separator for E-Chains*	
unassembled	3804
assembled	3814



Locking separator for E-Tubes	
unassembled	383
assembled	384



Asymmetric separator for E-Chains*	
unassembled	381A
assembled	382A



*For side-mounted applications

Option 1: Vertical separators and spacers

- **Standard separator 381 for E-Chains®** offers safe stability due to its broad foot design, also when used with thick cables or hoses.
- **Vertical separator 3881 with a narrow foot (7 mm) for E-Chains®** with applications where a large number of small cables need to be individually separated.
- The **vertical separator 381T for E-Tubes** clamps to the fixed radius and remains free along the other radius to facilitate lid removal. If installing these yourself, please ensure that they are identically aligned.
- Separators (e.g. "side mounted") for E-Chains® can be fixed in their position with **spacers 381.XX**. The available inner height will be reduced by 2 mm, per spacer and side. To avoid this, the parts can be assembled on outside of the crossbar (not for long travels) **XX = width of the spacer** (available 10, 15 and 20)

Additionally:

- **Locking separator 3804 for E-Chains®** - with increased retention force for applications exposed to very high humidity or extreme loads. The extra retention force is achieved by asymmetric claws for the crossbar. Ensure proper alignment.
- **Locking separator 383 for E-Chains®** - with increased retention force for applications exposed to very high humidity or extreme loads. The extra retention force is achieved by asymmetric claws for the crossbar. Ensure proper alignment.
- **Asymmetric separator 381A for E-Chains®** (not for E-Tubes) with an 14-mm base, for combinations between spacers of different widths and vertical separators in side-mounted

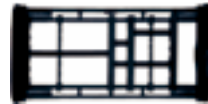
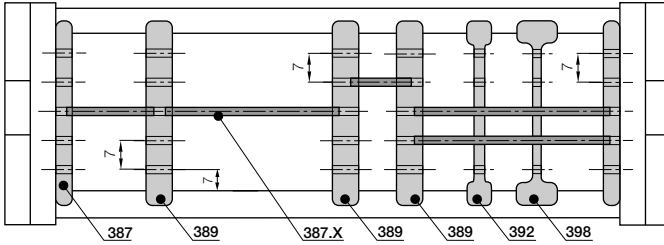

For use with many cables of differing diameters. E-Chains® and E-Tubes can be subdivided both vertically and horizontally. The shelves can be arranged elevator-shifted with different bottoms

Option 2: Shelves

● Side plates 386, middle plates 388 and shelves 386.X form the basic pattern of a shelf system. Shelves of various widths can be arranged at 5 different heights (in 7 mm increments).

● Slotted separators 391 are used for very fine subdivisions. However, they cannot be retrofitted into an existing separation system without dismantling the interior separators first.

● The unilateral open slotted separator 397 can be retrofitted into an existing interior separation system without a need for dismantling the interior separators. During an installation of open slotted separators, the top and bottom notches cannot be occupied by shelves.

Side plate for E-Chains®/E-Tubes	
unassembled	386
assembled	387

Middle plate for E-Chains®/E-Tubes	
unassembled	388
assembled	389

Slotted separator for E-Chains®/E-Tubes	
unassembled	391
assembled	392

Open slotted separator for E-Chains®/E-Tubes	
unassembled	397
assembled	398

Width X [mm]	Part No. unassembled	Part No. assembled
018	386.18	387.18
023	386.23	387.23
025	386.25	387.25
028	386.28	387.28
033	386.33	387.33
043	386.43	387.43
050	386.50	387.50
054	386.54	387.54
062	386.62	387.62

Width X [mm]	Part No. unassembled	Part No. assembled
075	386.75	387.75
087	386.87	387.87
100	386.100	387.100
108	386.108	387.108
125	386.125	387.125
150	386.150	387.150
175	386.175	387.175
200	386.200	387.200
208	386.208	387.208



Side plate 386



Middle plate 388

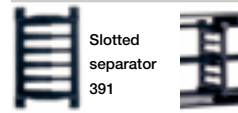

Slotted separator 391

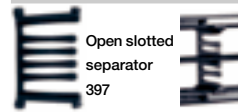

Open slotted separator 397



Shelf 386.X

Shelf

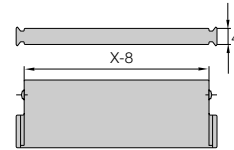

System E4/4
Inner height: 42 mm

Phone +49- (0) 22 03-96 49-800
Fax +49- (0) 22 03-96 49-222

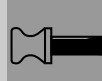



Extension links - for extremely wide E-Chains® up to 3,0 m

- For applications in which particularly high fill weights necessitate extremely wide E-Chains® (up to 3000 mm)
- The extension link design allows virtually limitless side-by-side attachment of chains
- The unsupported length of a chain can be increased when additional loads are required
- Extension links can be used with E-Chains®, E-Tubes or as a combination of both
- They are suitable for unsupported and gliding applications in a guide trough
- E-Chains® with extension links are attached with KMA or steel mounting brackets

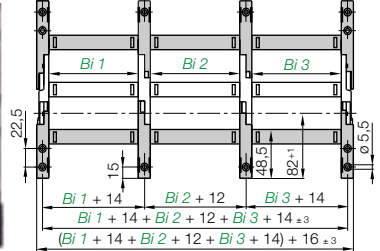
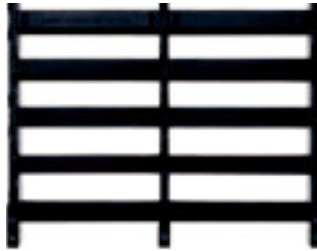

Part No. structure
3838.10 /20 /10. [200] .0
3838.Bi1/Bi2/Bi3. [R] .0



Consult igus® for your extender crossbar applications. We are happy to assist you with your design layout

Extender crossbars - careful guide of hoses applications

- Suitable for hoses with a maximum outer diameter of 115 mm
- Gliding operation with crossbars assembled along the outer radius and a special guide trough
- Gliding operation not guaranteed with crossbars assembled along the inner radius
- The extender crossbar can either be attached to the side links directly or can be used in combination with two stranded snap-open crossbars

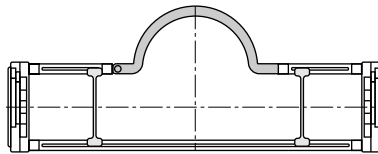

385.15RHD115 round extender crossbar combined with snap-open crossbars

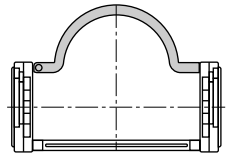

385.18RD115 round strap assembled directly on the side section

Part No.	Max Ø [mm] hose	Form	Installation side link	Combination with snap-open crossb.
385.15.RHD115	115	○	-	+
385.18.RD115	115	○	+	-

○ = round + = yes / - = no

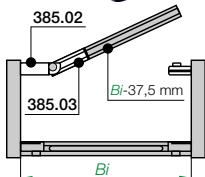

Hinged crossbars

- Typically E-Chain® crossbars are completely removable. In cases where the snap-open crossbars have to remain at the open link of the E-Chain®, a hinged design has been developed
- Length: 37,5 mm **Part No. 385.02** / snap-open crossbar (shortened): Bi-37,5 mm **Part No. 385.03**
- Please consult igus® for design assistance

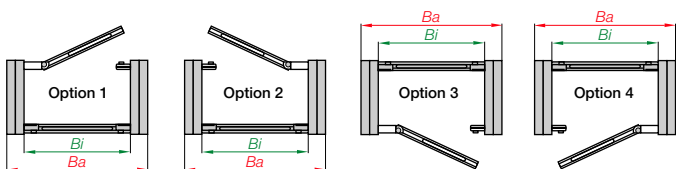

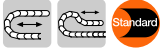

The Standard - Option KMA* - pivoting

- Recommended for unsupported and gliding applications
- Confined installation conditions
- Option - integrated C-profile strain relief device with Chainfix clip or strain relief tiwrap plates
- Corrosion resistant
- Universal mountable with attachment capability on all sides

*KMA = Polymer Metal Mounting Bracket

Moving end
38380/78380...1

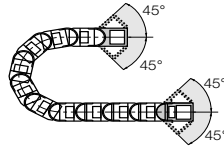

Fixed end
38380/78380...2



The attachment variants arising automatically by the choice of the KMA mounting bracket

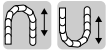
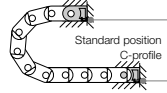

Option KMA - locking

- Recommended for vertical hanging / standing applications

Additionally:

- Universal mountable
- C-profile option
- Corrosion resistant
- Locked connections
- At very high acceleration

Moving end
39380/79380...1

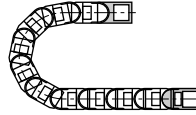

Fixed end
39380/79380...2



The attachment variants arising automatically by the choice of the KMA mounting bracket

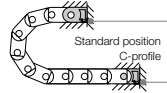

Fixed end

38380/78380...2 (pivoting)
39380/79380...2 (locking)

Moving end

(pivoting) 38380/78380...1
(locking) 39380/79380...1

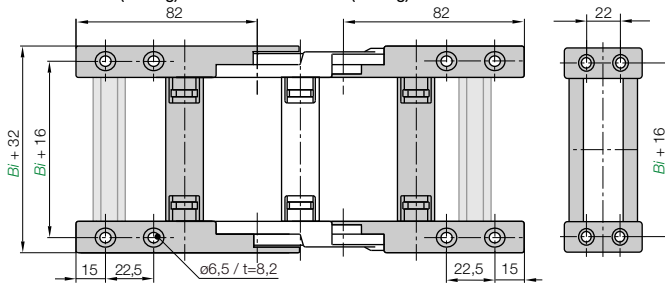

Dimensions and order configurations

Part No. structure (pivoting)

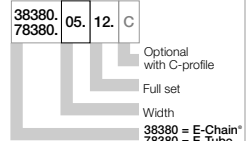

Part No. structure (locking)

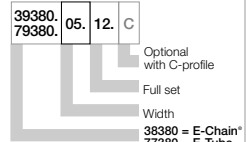

Width index	Part No. full set		C-profile option [mm]	Bi	Width index	Part No. full set		C-profile option [mm]	Bi
	pivoting	locking				pivoting	locking		
.05.	▶ 38380	▶ 78380	▶ .05.12.C	50	.23.	▶ 38380	▶ 39380	▶ .23.12.C	225
.06.	▶ 38380	▶ 39380	▶ .06.12.C	68	.237.	▶ 38380	▶ 39380	▶ .237.12.C	237
.07.	▶ 38380	▶ 78380	▶ .07.12.C	75	.25.	▶ 38380/78380	▶ 39380/79380	▶ .25.12.C	250
.087.	▶ 38380	▶ 39380	▶ .087.12.C	87	.262.	▶ 38380	▶ 39380	▶ .262.12.C	262
.10.	▶ 38380	▶ 78380	▶ .10.12.C	100	.28.	▶ 38380	▶ 39380	▶ .28.12.C	275
.11.	▶ 38380	▶ 78380	▶ .11.12.C	108	.29.	▶ 38380	▶ 39380	▶ .29.12.C	287
.112.	▶ 38380	▶ 39380	▶ .112.12.C	112	.30.	▶ 38380/78380	▶ 39380/79380	▶ .30.12.C	300
.12.	▶ 38380	▶ 78380	▶ .12.12.C	125	.312.	▶ 38380	▶ 39380	▶ .312.12.C	312
.137.	▶ 38380	▶ 39380	▶ .137.12.C	137	.325.	▶ 38380	▶ 39380	▶ .325.12.C	325
.15.	▶ 38380	▶ 78380	▶ .15.12.C	150	.337.	▶ 38380	▶ 39380	▶ .337.12.C	337
.162.	▶ 38380	▶ 39380	▶ .162.12.C	162	.350.	▶ 38380	▶ 39380	▶ .350.12.C	350
.17.	▶ 38380	▶ 78380	▶ .17.12.C	178	.362.	▶ 38380	▶ 39380	▶ .362.12.C	362
.18.	▶ 38380	▶ 39380	▶ .18.12.C	175	.375.	▶ 38380	▶ 39380	▶ .375.12.C	375
.187.	▶ 38380	▶ 39380	▶ .187.12.C	187	.387.	▶ 38380	▶ 39380	▶ .387.12.C	387
.20.	▶ 38380	▶ 78380	▶ .20.12.C	200	.400.	▶ 38380	▶ 39380	▶ .400.12.C	400
.212.	▶ 38380	▶ 39380	▶ .212.12.C	212					

Full set, for both ends:

38380.05.12

Single-part order:

38380.05.1

Mounting bracket moving end

38380.05.2

Mounting bracket fixed end





Option steel - pivoting

- For pivoting connections
- One part (two-piece) for all chain widths
- Electrically conductive

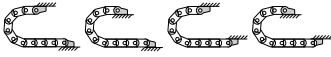

Possible installation conditions -

Further installation angles ► installation sketch

Moving end
38380.1

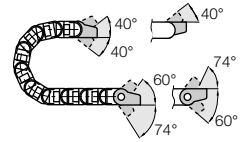

Fixed end
38380.2

Phone +49- (0) 22 03-96 49-800
Fax +49- (0) 22 03-96 49-222

igus® GmbH
51147 Cologne

Internet: www.igus.de
E-mail: info@igus.de

Moving end
38380.1

Fixed end
38380.2

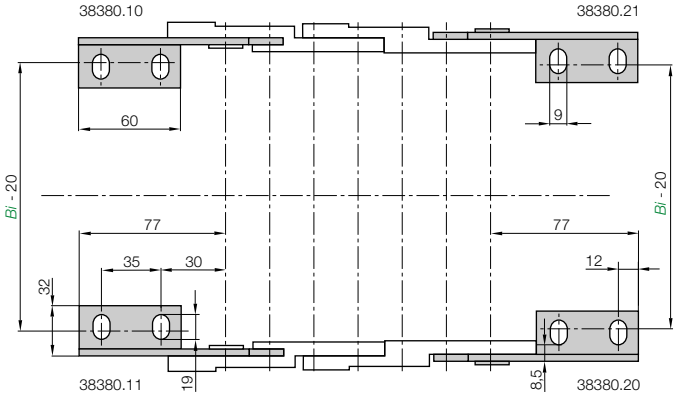

For E-Chain®	Part No. full set	Bi [mm]	For E-Chain®	Part No. full set	Bi [mm]
3838-3938-7838.05 ►	38380.12	50	3838-3938.23 ►	38380.12	225
3838-3938.06 ►	38380.12	68	3838-3938.237 ►	38380.12	237
3838-3938-7838.07 ►	38380.12	75	3838-3938-7838.25 ►	38380.12	250
3838-3938.087 ►	38380.12	87	3838-3938.262 ►	38380.12	262
3838-3938-7838.10 ►	38380.12	100	3838-3938.28 ►	38380.12	275
3838-3938-7838.11 ►	38380.12	108	3838-3938.29 ►	38380.12	287
3838-3938.112 ►	38380.12	112	3838-3938-7838.30 ►	38380.12	300
3838-3938-7838.12 ►	38380.12	125	3838-3938.312 ►	38380.12	312
3838-3938.137 ►	38380.12	137	3838-3938.325 ►	38380.12	325
3838-3938-7838.15 ►	38380.12	150	3838-3938.337 ►	38380.12	337
3838-3938.162 ►	38380.12	162	3838-3938.350 ►	38380.12	350
3838-3938-7838.17 ►	38380.12	168	3838-3938.362 ►	38380.12	362
3838-3938.18 ►	38380.12	175	3838-3938.375 ►	38380.12	375
3838-3938.187 ►	38380.12	187	3838-3938.387 ►	38380.12	387
3838-3938-7838.20 ►	38380.12	200	3838-3938.400 ►	38380.12	400
3838-3938.212 ►	38380.12	212			

38380.12 Full set, 4 parts

2 with pin / 2 with bore

Single-part order:

38380.1 Mounting bracket moving end, 1 part left / right

38380.2 Mounting bracket fixed end, 1 part left / right

Other strain relief elements

► chapter 10

Chainfix clamps for the C-profile

Part No. single clamps		Part No. double clamps		Part No. triple clamps		Cable
steel	stainless steel	steel	stainless steel	steel	stainless steel	ø [mm]
CFX12.1	CFX12.1.E	CFX12.2	CFX12.2.E	CFX12.3	-	06 - 12
CFX14.1	CFX14.1.E	CFX14.2	CFX14.2.E	CFX14.3	-	12 - 14
CFX16.1	CFX16.1.E	CFX16.2	CFX16.2.E	CFX16.3	-	14 - 16
CFX18.1	CFX18.1.E	CFX18.2	CFX18.2.E	CFX18.3	-	16 - 18
CFX20.1	CFX20.1.E	CFX20.2	CFX20.2.E	CFX20.3	-	18 - 20
CFX22.1	CFX22.1.E	CFX22.2	CFX22.2.E	CFX22.3	-	20 - 22
CFX26.1	CFX26.1.E	CFX26.2	CFX26.2.E	-	-	22 - 26
CFX30.1	CFX30.1.E	CFX30.2	CFX30.2.E	-	-	26 - 30
CFX34.1	CFX34.1.E	CFX34.2	CFX34.2.E	-	-	30 - 34
CFX38.1	CFX38.1.E	-	-	-	-	34 - 38
CFX42.1	CFX42.1.E	-	-	-	-	38 - 42



igus® Chainfix steel clamps and Chainfix stainless-steel clamps - max. pull forces, adjustable with hexagon socket. Available as single, double or triple clamps. **Details ▶ chapter 10**

System E4/4
Inner height: 42 mm

Cable ø [mm]	Part No. clamp	Part No. bottom part
04 - 08	CFC-08-M	CFC-08-C
08 - 12	CFC-12-M	CFC-12-C
12 - 16	CFC-16-M	CFC-16-C
16 - 20	CFC-20-M	CFC-20-C
20 - 24	CFC-24-M	CFC-24-C

Chainfix Clip - Modular snap-on strain relief device for C-profile

Available for all igus® E-ChainSystems® with C-profiles and also suitable for assembly in the KMA mounting brackets and clip-on strain relief for crossbars. High pull forces, plug-in modular snap-on strain relief device. **Details ▶ chapter 10**



Part No.	ø max. conduit [mm]	Width [mm]
CFN.20	20	10,8
CFN.30.52	30	16,8
CFN.20.N35	20	20,0

Chainfix Nugget for the C-Profile

Strain relief for the fixation of cables up to a diameter of Ø 30 mm. Easy to assemble, without any screws and tools. Easy strain relief due to fixation with pre-hressed cable strap, very small space requirement. **Details ▶ chapter 10**



Part No.	Width of strain relief [mm]	Number of teeth
3050.ZC	50	5
3075.ZC	75	7

Chainfix tiwrap plates with clip-on connection for the C-profile

Can be plugged into the KMA C-profile. Easy to assemble without any screws. Easily solvable with screwdriver nevertheless safe stop. For all E-Chains® with KMA and integrated C-profile. **Details ▶ chapter 10**

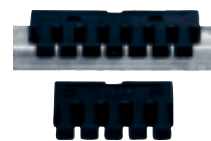

Tiewrap plate	No. of teeth n	Dim. C [mm]	Dim. B [mm]	Center bore
3050.ZB	5	50	30	-
3075.ZB	7	75	55	-
3100.ZB	10	100	80	-
3115.ZB	11	115	95	-
3125.ZB	12	125	105	-
3150.ZB	15	150	130	-
3175.ZB	17	175	155	-
3200.ZB	20	200	180	+
3225.ZB	22	225	205	+
3250.ZB	25	250	230	+

(- = no / + = yes)

Tiewrap plate as individual part

As individual component screwed on KMA. Can be plugged in the mounting brackets. **Details ▶ chapter 10**

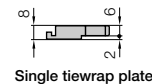
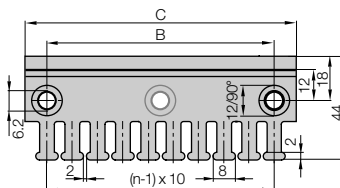

Single tiwrap plate

Shown assembled

Details about all strain relief option for this series ▶ chapter 10

Phone +49- (0) 22 03-96 49-800
Fax +49- (0) 22 03-96 49-222



▶ Chapter 10



▶ page 7.223

- B_a = Outer width E-Chains* / E-Tube
- B_i = Inner width E-Chains* / E-Tube
- h_a = Outer height E-Chains* / E-Tube
- H_{Ri} = Inner trough height
- H_{Ra} = Outer trough height
- B_{Ri} = Inner trough width ► depends on dim. B_a
- B_{Ra} = Outer trough width
- n_{Mon} = Number of installation sets (left/right)
- n_{Ri} = Number of troughs sets (left/right)
- $H_{Ri} \geq 2 \cdot h_a$
- $B_{Ri} \geq B_a + 4$
- = Guide trough set ● = Glide bar
- = Installation set "Basic" ● = C-profile

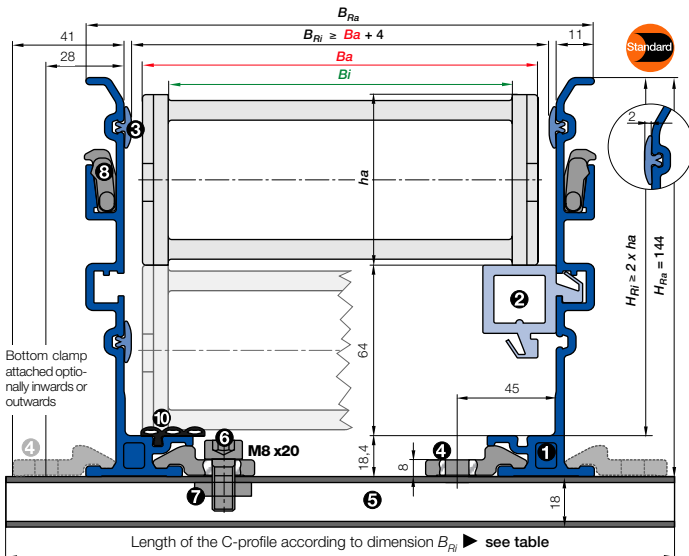

- **Components, trough "Basic":** ① Trough side parts, aluminum, 2 m ② Glide bar, plastic, 2 m ③ Glide strips, plastic, 2 m (without glide strips on request) ⑩ Optional: Silencer profile, rubber
- **Components, installation set "Basic":** ④ Bottom clamp, aluminum ⑤ C-profile, steel galvanized ⑥ Screw M8 x20 ⑦ Sliding nut M8 ⑧ Interface connector, plastic



Order example: Length of travel 30 m - Center mounted for Series 3838.20.300.0 with $B_{Ri} = 231$

- Guide trough set (set of 2 trough side parts, incl. glide strips) **without** glide bar
Order text: 16 m guide trough without glide bar (8 x 2 m sections) **Part No. 973.30.SL**
- Guide trough set (set of 2 trough side parts, incl. glide strips) **with** glide bar
Order text: 16 m guide trough with glide bar (8 x 2 m sections) **Part No. 973.31.SL**
- Installation set "Basic" complete (guide trough-sets + 1)
Order text: 17 installation sets "Basic" **Part No. 960.40.300**
- Module for the fixed end
Order text: 1 set **Part No. 973.81**
- Option:** For an additional noise dampening with silencer profile, please add Index A - Example: **Part No. 973.30.SLA**

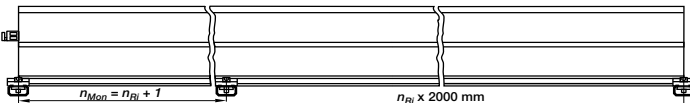

Principle sketch: Number of installation sets to be installed = **Number of trough sections + 1**



A quick fix for mounting the stationary end of an E-Chain®
With this module for the fixed end, fast and easy mounting onto the Aluminum "SuperTrough" is now possible without any drilling. Fast mounting of the E-Chain® by clamping onto the aluminum trough
● Quick relocation of the stationary end ● No drilling necessary ► **page 9.16**

Installation set "Basic" with C-profile

Bottom Clamp attached optionally inwards or outwards

3838.05.300.0 ► Order example

	Part No.	
	B_{Ri} attached inwards [mm]	attached outwards
.05	81	960.40.200
.06	99	960.40.225
.07	106	960.40.225
.087	119	960.40.175
.10	131	960.40.200
.11	139	960.40.200
.112	144	960.40.200
.12	156	960.40.225
.137	169	960.40.225
.15	181	960.40.250
.162	194	960.40.250
.17	199	960.40.250
.18	206	960.40.275
.187	219	960.40.275
.20	231	960.40.300
.212	244	960.40.300
.23	256	960.40.325
.237	269	960.40.325
.25	281	960.40.350
.262	294	960.40.350
.28	306	960.40.375
.29	319	960.40.375
.30	331	960.40.400
.312	344	960.40.400
.325	356	960.40.425
.337	369	960.40.425
.350	381	960.40.450
.362	394	960.40.450
.375	406	960.40.475
.387	419	960.40.475
.400	431	960.40.500

Insert for the installation set "Heavy-Duty": **973.50.XXX** instead of (960.40.XXX) on the right column "attached outwards"

Phone+49- (0) 22 03-96 49-800
Fax +49- (0) 22 03-96 49-222

igus® GmbH
51147 Cologne

Internet: www.igus.eu
E-mail: info@igus.de



E4/4 as ZigZag version in this crane. The E4-Series guarantee very high availability of the facility, so that the production of new truck can be started up on an average of every seven minutes

System E4/4
Inner height: 42 mm

Phone +49- (0) 22 03-96 49-800
Fax +49- (0) 22 03-96 49-222



► Chapter 9



► page 7.223

Price index

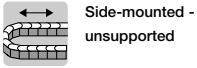

Side-mounted - unsupported



ESD classification:
Electrically conductive ESD/ATEX version upon request



High torsional rigidity



Opening E-Chains: Remove crossbars and clips - Insert screwdriver into the slot, push down, release by lever action



Remove lids/bottoms (E-Tubes) - Insert screwdriver into the slot, release by lever action



When to use the Series 4040/4140/R8840:

- When high torsional forces are expected
- For side-mounted applications involving large unsupported lengths
- For long-term operation in very moist environments
- Also available as Rol E-Chain®



When not to use it:

- If a quieter version is required
▶ Series E4.56, page 7.62
- If a simple and low-cost solution is required
▶ Series 14040/R18840, page 7.124
- When very long travels or high additional loads are involved
▶ Series 4040HD, page 7.260

- ① High side-mount stability due to undercut
- ② High torsional rigidity
- ③ Closed and open styles can be combined
- ④ Hinged snap-open removable lids of E-Tube
- ⑤ Numerous interior separation possibilities
- ⑥ Crossbars on E-Chains® are removable along both radii
- ⑦ Lateral glide surfaces for side-mounted operation
- ⑧ Wide, rounded plastic crossbars - cable friendly
- ⑨ KMA mounting brackets with attachment points on all sides
- ⑩ Mounting brackets with integrated strain relief available, locking or pivoting
- ⑪ E-Chains® also available with reverse bending radius "RBR"

! "Heavy-Duty" size available. Greater unsupported length for higher loads and travels. Also available as Rol E-Chain® version



Rol E-Chain® Series 4040R/8840R available upon request



Order example complete E-Chain®

Please indicate chain-lengths or number of links Example: 5 m or 55 links

5 m 4040.30.300.0

E-Chain®

with 2 separators 411 assembled every 2nd link

Interior separation

1 set 40400.30.12C

Mounting bracket



Unsupported length

FL_G = with straight upper run

FL_B = with permitted sag

Further information ► **Design, page 1.12**

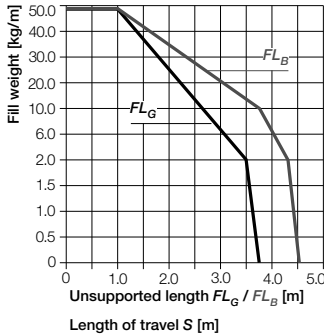
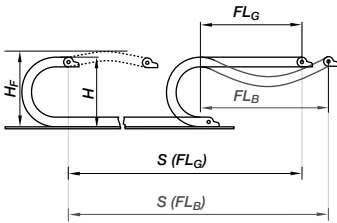

- S = Length of travel
 - R = Bending radius
 - H = Nominal clearance height
 - H_F = Required clearance height
 - H_{R1} = Trough inner height
 - D = Overlength E-Chain" radius in final position
 - $K = \pi \cdot R + \text{"safety"}$
 - D_2 = Over length - long travels, gliding
 - K_2 = "Further add-on
 - H_2 = "Mounting height
- *if the mounting bracket location is set lower

Other installation methods

- Vertical, hanging ≤ 100 m
- Vertical, standing ≤ 6 m
- Side mounted, un supp. ≤ 3 m
- Rotary requires further calculation
- Unsupported length of upper run = upon request

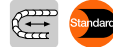

Short travels - unsupported

Unsupported E-Chains" feature positive camber over short travels. This must be accounted for when specifying the clearance height H_F . Please consult igus" if space is particularly restricted.

The required clearance height:

$H_F = H + 50$ mm
(with 3,0 kg/m fill weight)

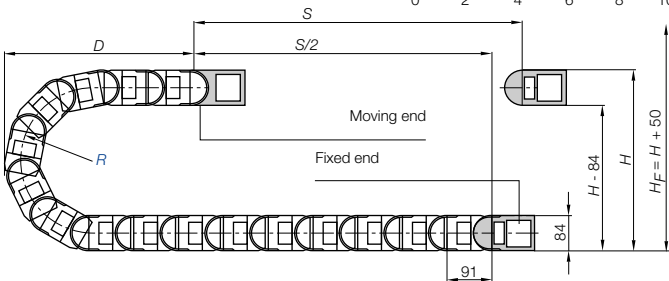

Pitch = 91 mm/link Links/m = 11 (1001 mm) Chain length = $S/2 + K$

R	135	150	175	200	240	250	300	350	400	500
$H_{2,25}$	360	385	435	485	565	585	685	785	885	1085
D	270	285	310	335	375	385	435	485	535	635
K	650	750	825	900	1020	1050	1225	1340	1450	1775
H_2	360	266	266	266	266	266	266	266	266	266
$D_{2,25}$	270	480	600	730	930	940	1180	1440	1530	1850
K_2	650	819	1092	1274	1547	1547	2002	2366	2548	3185

Long travel lengths from 10 m to max. 300 m Chain length = $S/2 + K_2$

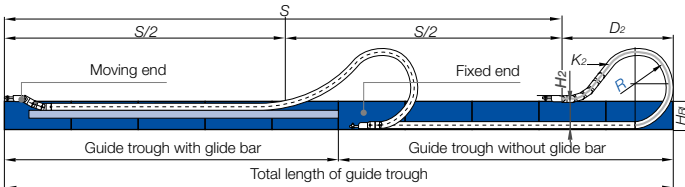

In case of travels between 4 and 10 m we recommend a longer unsupported length.



Gliding, long travel applications (max. 300 m)

In this case the E-Chain" upper run will be introduced in a guide trough on the lower run. We recommend to realize the engineering of such a plant by our technicians.

Technical Data

Speed / acceleration FL_G	max. 20 [m/s] / max. 200 [m/s ²]
Speed / acceleration FL_B	max. 3 [m/s] / max. 6 [m/s ²]
Gliding speed / acceleration (maximum)	max. 10 [m/s] / max. 50 [m/s ²]
Material - permitted temperature °C	igumid G / -40° up to +120° C
Flammability class, igumid G	VDE 0304 IIC UL94 HB



Details of material properties

► page 1.38

56

System E4/4
Inner height: 56 mm

Phone +49- (0) 22 03-96 49-800
Fax +49- (0) 22 03-96 49-222



► page 7.223

igus® E-ChainSystems®

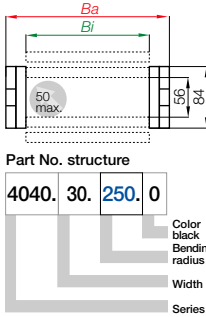

Series 4040- E-Chain® with crossbars every link

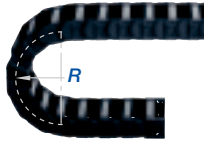

- Crossbars every link
- For rigid hydraulic hoses
- For applications particularly demanding
- Can be opened from two sides



Phone+49- (0) 22 03-96 49-800
Fax +49- (0) 22 03-96 49-222

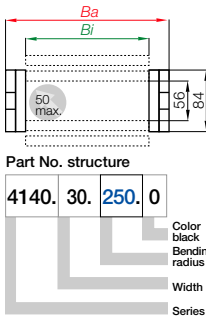

Series 4140 - E-Chain® with crossbars every 2nd link

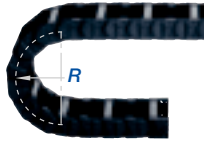

- Crossbars every 2nd link = Standard
- For nearly every situation
- Can be opened from two sides
- Easy assembly
- Stable
- Attractive price



igus® GmbH
51147 Cologne

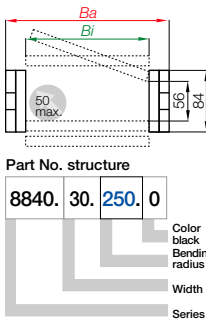

Series R8840 - Fully enclosed E-Tube

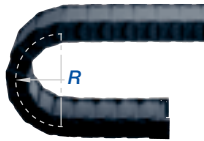

- Fully enclosed
- Excellent cable protection against dirt
- Protection against hot chips (up to 900°C)
- Lids along the entire inner radius are completely removable. Lids along the entire outer radius are single sided snap-open with a hinge on the other side to keep them attached to the chain or completely removable.



Internet: www.igus.eu
E-mail: info@igus.de

Rol instead of gliding: Rol E-Chain®

Special solution for long travels. 75% less drive power (gliding application) with igus® Rol E-Chain®.
Series 4040R - Order example 4040R.30.250.0
Further information: www.igus.de/en/role or phone: +49-0 22 03-96 49-800



Part No.	<i>Bi</i> [mm]	<i>Ba</i> [mm]	4040 [kg/m]	4140 [kg/m]	R8840 [kg/m]	
4040/4140.05.	0	50	86	≈ 3,65	≈ 3,58	-
4040/4140.06.	0	65	101	≈ 3,67	≈ 3,60	-
4040/4140/8840.07.	0*	75	111	≈ 3,78	≈ 3,70	≈ 4,24
4040/4140.08.	0	87	123	≈ 3,83	≈ 3,75	-
4040/4140/8840.10.	0	100	136	≈ 3,96	≈ 3,78	≈ 4,52
4040/4140.11.	0	112	149	≈ 4,09	≈ 3,85	-
4040/4140/8840.12.	0	125	161	≈ 4,16	≈ 3,88	≈ 4,88
4040/4140.13.	0	137	174	≈ 4,29	≈ 3,95	-
4040/4140/8840.15.	0	150	186	≈ 4,36	≈ 3,98	≈ 5,31
4040/4140.16.	0	162	199	≈ 4,47	≈ 4,04	-
4040/4140.17.	0	175	211	≈ 4,58	≈ 4,09	-
4040/4140.18.	0	187	224	≈ 4,69	≈ 4,15	-
4040/4140/8840.20.	0	200	236	≈ 4,71	≈ 4,16	≈ 5,89
4040/4140.21.	0	212	249	≈ 4,82	≈ 4,21	-
4040/4140.22.	0	225	261	≈ 4,88	≈ 4,25	-
4040/4140.23.	0	237	274	≈ 5,02	≈ 4,31	-
4040/4140/8840.25.	0	250	286	≈ 5,10	≈ 4,36	≈ 6,61
4040/4140.26.	0	262	299	≈ 5,19	≈ 4,40	-
4040/4140/8840.27.	0	275	311	≈ 5,30	≈ 4,46	≈ 6,89
4040/4140.28.	0	287	324	≈ 5,32	≈ 4,47	-
4040/4140/8840.30.	0	300	336	≈ 5,54	≈ 4,58	≈ 7,27
4040/4140.31.	0	312	349	≈ 5,58	≈ 4,60	-
4040/4140.32.	0	325	361	≈ 5,63	≈ 4,62	-
4040/4140.33.	0	337	374	≈ 5,81	≈ 4,71	-
4040/4140/8840.35.	0	350	386	≈ 5,96	≈ 4,79	≈ 8,02
4040/4140.36.	0	362	399	≈ 5,96	≈ 4,79	-
4040/4140.37.	0	375	411	≈ 5,98	≈ 4,80	-
4040/4140.38.	0	387	424	≈ 6,07	≈ 4,84	-
4040/4140/8840.40.	0	400	436	≈ 6,27	≈ 4,94	≈ 8,98
4040/4140.41.	0	412	449	≈ 6,42	≈ 5,02	-
4040/4140.42.	0	425	461	≈ 6,58	≈ 5,09	-
4040/4140.43.	0	437	474	≈ 6,64	≈ 5,13	-
4040/4140.45.	0	450	486	≈ 6,71	≈ 5,16	-
4040/4140/8840.46.	0	462	499	≈ 6,73	≈ 5,19	≈ 9,44
4040/4140.47.	0	475	511	≈ 6,86	≈ 5,24	-
4040/4140.48.	0	487	524	≈ 6,88	≈ 5,28	-
4040/4140.50.	0	500	536	≈ 7,00	≈ 5,30	-
4040/4140.51.	0	512	549	≈ 7,02	≈ 5,31	-
4040/4140.52.	0	525	561	≈ 7,06	≈ 5,34	-
4040/4140.53.	0	537	574	≈ 7,22	≈ 5,41	-
4040/4140.55.	0	550	586	≈ 7,70	≈ 5,65	-
4040/4140.60.	0	600	636	≈ 7,90	≈ 5,75	-

Available bending radii

R [mm] 135** 150 175 200 240 250 300 350 400 500

Supplement Part No. with required radius. Example: 4040.30.300.0

0 = standard color, other colors ▶ page 1.39 · Pitch = 91 mm/link · Links/m = 11

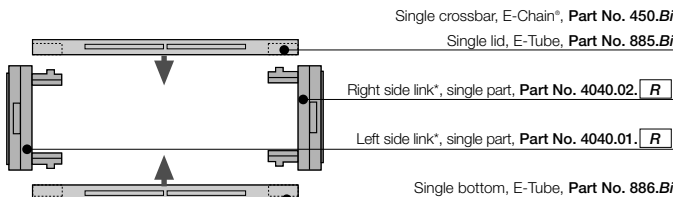

Hot Chips up to 850°C

E-Tubes that repel hot chips, up to 850°C. Some applications, depending on amount and size of the chips, can burn or melt the surface. That is no longer the case with the igus® "igumid-HT" material. Order example:

Full E-Tube made of HT:

8840.40.150.0.HT

Lids made of HT:

8840.40.HTE.150.0

for long travels upon request

Further information:

www.igus.de/en/HT

Delivery time
up to 4 weeks!

Extreme Glider...

...with up to 70% larger glide surface. For high additional loads and high gliding speeds. Gliding applications without additional elements as well as 150% more wear allowance and improvement of service life by factor 4!

Order example:

4040.35G.250.0

4040.45G.250.0

Further information:

phone +49-0 22 03-96 49-800



* Removable lid only, no hinged option

** not available for R8840



Extender crossbar for large diameter hoses ▶ page 7.254

Part No. E-Chain® - links, single parts

*View from the fixed point of the E-Chain®/E-Tube

System E4/4
Inner height: 56 mm

Phone +49- (0) 22 03-96 49-800
Fax +49- (0) 22 03-96 49-222



▶ page 7.223



Vertical separators are used if a vertical subdivision is required. In the standard configuration, a separator is mounted at every second link. **Note:** Observe a lateral spacing of at least 33 mm (E-Tube) and 16 mm (E-Chain)!

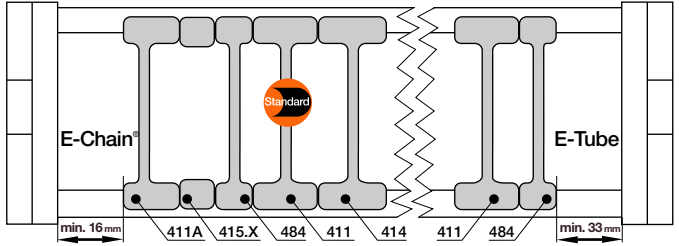

Vertical separator
401



Vertical separator
483



Spacer
405.XX



Locking separator
404



Vertical separator
406



Asymmetric
separator 401A



**Vertical separator
for E-Chains®/E-Tubes**

unassembled	401
assembled	411



**Vertical separator
for E-Chains®/E-Tubes**

unassembled	483
assembled	484



**Spacer®
for E-Chains®**

unassembled	405.XX
assembled	415.XX



**Locking separator
for E-Chains®**

unassembled	404
assembled	414



**Vertical separator
for E-Tubes**

unassembled	406
assembled	416



**Asymmetric separator
for E-Chains®**

unassembled	401A
assembled	411A



*For side-mounted applications

Option 1: Vertical separators and spacers

● **Standard separator 401 for E-Chains®/E-Tubes** offers safe stability due to its broad foot design, also when used with thick cables or hoses.

● **Vertical separator 483 with a narrow foot for E-Chains® and E-Tubes** with applications where a large number of small cables need to be individually separated.

● Separators (e.g. "side mounted") for E-Chains® can be fixed in their position with **Spacers 405.XX**. The available inner height will be reduced by 2 mm, per spacer and side. To avoid this, the parts can be assembled on outside of the crossbar (not for long travels) **XX = width of the spacer** (available 10, 15, 20, 30 and 40 mm)

Additionally:

● **Locking separator for E-Chains® 404** - with increased retention force for applications exposed to very high humidity or extreme loads. The extra retention force is achieved by asymmetric claws for the crossbar. Ensure proper alignment

● **Locking separator 406 for E4-Tubes** - safe fitting locked on lid or bottom of the Tube and sideways slideable. The opposing lid or bottom can easily be opened and closed. Especially capable if many separators need to be assembled on a tight inner width

● **Asymmetric separator 401A for E-Chains®** with an 18-mm base, for combinations between spacers of different widths and vertical separators in side-mounted applications, for instance.

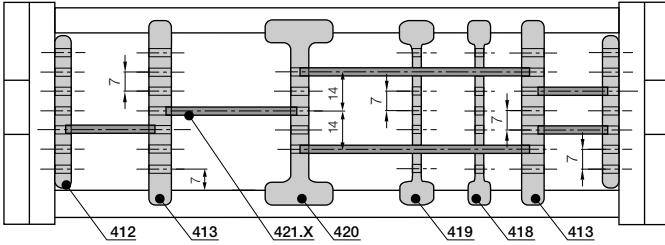

For use with many cables of differing diameters. E-Chains[®] and E-Tubes can be subdivided both vertically and horizontally. The shelves can be arranged elevator-shifted with different bottoms

Option 2: Shelves

● Side plates 402, middle plates 403 and shelves 420.X form the basic pattern of a shelf system. Shelves of various widths can be arranged at 7 different heights (in 7 mm increments).

● Locking vertical separator 410, slotted combined with shelves (only for E-Chains[®]).

● Slotted separators 408 are used for very fine subdivisions. However, they cannot be retrofitted into an existing separation system without dismantling the interior separators first.

● The unilateral open slotted separator 409 can be retrofitted into an existing interior separation system without a need for dismantling the interior separators. During an installation of open slotted separators, the top and bottom notches cannot be occupied by shelves.

Side plate for E-Chains [®] /E-Tubes		
unassembled		402
assembled		412

Middle plate for E-Chains [®] /E-Tubes		
unassembled		403
assembled		413

Locking vertical separator for E-Chains [®]		
unassembled		410
assembled		420

Slotted separator for E-Chains [®] /E-Tubes		
unassembled		408
assembled		418

Open slotted separator for E-Chains [®] /E-Tubes		
unassembled		409
assembled		419

Width X [mm]	Part No. unassembled	Part No. assembled
018	420.18	421.18
023	420.23	421.23
025	420.25	421.25
028	420.28	421.28
033	420.33	421.33
043	420.43	421.43
050	420.50	421.50
062	420.62	421.62

Width X [mm]	Part No. unassembled	Part No. assembled
075	420.75	421.75
088	420.88	421.88
100	420.100	421.100
125	420.125	421.125
150	420.150	421.150
175	420.175	421.175
187	420.187	421.187
200	420.200	421.200



Side plate 402

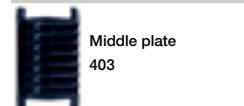

Middle plate 403



Locking vertical separator 410



Slotted separator 408

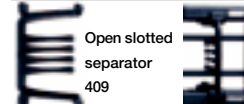

Open slotted separator 409



Shelf 420.X

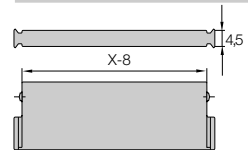

Additional elements for interior separation

Center crossbar		
unassembled		405
assembled		415

Center crossbar - was developed for applications with a large number of thin cables. The center crossbar offers the option of subdividing the E-Chain[®] independently into upper and lower halves.

Rollclip		
unassembled		489.27
assembled		490.27

Rollclip - minimizes abrasion of particularly sensitive hoses. The Rollclip is simply clamped onto the opening crossbar. The movable rollers compensate for relative movement between the chain and hose.

Roller separator		
unassembled		429
assembled		430

Roller separator - performs a similar function to the Rollclip, but doubles as a separator.

System E4/4
Inner height: 56 mm

Phone +49- (0) 22 03-96 49-800
Fax +49- (0) 22 03-96 49-222





Extension links - for extremely wide E-Chains® up to 3,0 m

- For applications in which particularly high fill weights necessitate extremely wide E-Chains® (up to 3000 mm)
- The extension link design allows virtually limitless side-by-side attachment of chains
- The unsupported length of a chain can be increased when additional loads are required
- Extension links can be used with E-Chains®, E-Tubes or as a combination of both
- They are suitable for unsupported and gliding applications in a guide trough
- E-Chains® with extension links are attached with KMA or steel mounting brackets

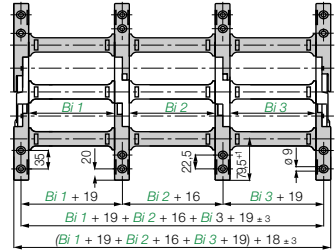

Part No. structure
4040.10 /20 /10. .0
4040.Bi1/Bi2/Bi3. .0



Extender crossbars - careful guide of hoses applications

- Suitable for hoses with a maximum outer diameter of 245 mm
- Gliding operation with crossbars assembled along the outer radius and a special guide trough
- Gliding operation not guaranteed with crossbars assembled along the inner radius
- The extender crossbar can either be attached to the side links directly or can be used in combination with two stranded snap-open crossbars

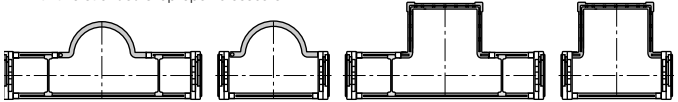

Round extender crossbar with snap-open crossbars Attached directly to the side link Square extender crossbar with snap-open crossbars Attached directly to the side link

Consult igus® for your extender crossbar applications. We are happy to assist you with your design layout

Part No.	Max Ø [mm] hose	Form	Installation side link	Combination with snap-open crossb.
450.15.RHD115	115	○	-	+
450.17.RD115	115	○	+	-
450.25.D150	150	□	+	-
450.30.D200	180	□	+	-
450.35.D250	195	□	+	-
450.40.D300	245	□	+	-
450.20.HD150	150	□	-	+
450.25.HD200	180	□	-	+
450.30.HD250	195	□	-	+

○ = round □ = square + = yes / - = no



E4 clip-on cable binder

- For side-mounted applications ● Serves as a clip-on, lateral guide for hoses and cables on E-Chains®
- The loops can be adjusted as required ● Compatible with many E4 E-Chains® ● Stylish and economical
- One clip and one locking band are needed for each chain link ● Call us if you have any questions on project planning

Part No.	Form
450.B12	Locking clip, comprising a locking element
450.B12.200	Locking band, comprising a locking element and band; 12 x 1,5 x 200 mm

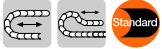

The Standard - Option KMA* - pivoting

- Recommended for unsupported and gliding applications
- Confined installation conditions
- Option - integrated C-profile strain relief device with Chainfix clip or strain relief tiwrap plates
- Corrosion resistant
- Universal mountable with attachment capability on all sides

*KMA = Polymer Metal Mounting Bracket

Moving end
40400/88400...1

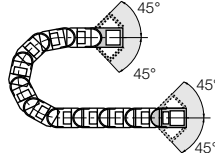

Fixed end
40400/88400...2



The attachment variants arising automatically by the choice of the KMA mounting bracket

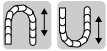
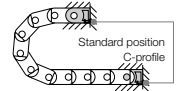

Option KMA - locking

- Recommended for vertical hanging / standing applications
- Additionally:**
- Universal mountable
 - C-profile option
 - Corrosion resistant
 - Locked connections
 - At very high acceleration

Moving end
41400/89400...1

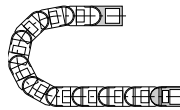

Fixed end
41400/89400...2



The attachment variants arising automatically by the choice of the KMA mounting bracket

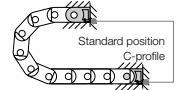

Fixed end
40400/88400...2 (pivoting)
41400/89400...2 (locking)

Moving end
(pivoting) 40400/88400...1
(locking) 41400/89400...1

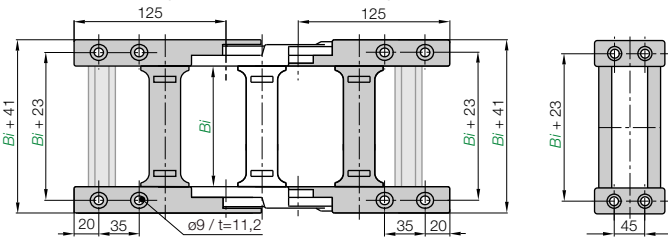

Dimensions and order configurations

Part No. structure (pivoting)

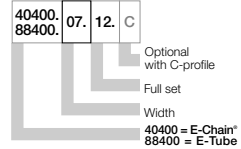

Part No. structure (locking)

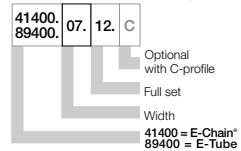

Width index	Part No. full set			C-profile option [mm]	Width index	Part No. full set			C-profile option [mm]
	pivoting	locking				pivoting	locking		
.05.	▶ 40400	41400	.05.12. [C]	50	.31.	▶ 40400	41400	.31.12. [C]	312
.06.	▶ 40400	41400	.06.12. [C]	65	.32.	▶ 40400	41400	.32.12. [C]	325
.07.	▶ 40400/88400	41400/89400	.07.12. [C]	75	.33.	▶ 40400	41400	.33.12. [C]	337
.08.	▶ 40400	41400	.08.12. [C]	87	.35.	▶ 40400/88400	41400/89400	.35.12. [C]	350
.10.	▶ 40400/88400	41400/89400	.10.12. [C]	100	.36.	▶ 40400	41400	.36.12. [C]	362
.11.	▶ 40400	41400	.11.12. [C]	112	.37.	▶ 40400	41400	.37.12. [C]	375
.12.	▶ 40400/88400	41400/89400	.12.12. [C]	125	.38.	▶ 40400	41400	.38.12. [C]	387
.13.	▶ 40400	41400	.13.12. [C]	137	.40.	▶ 40400/88400	41400/89400	.40.12. [C]	400
.15.	▶ 40400/88400	41400/89400	.15.12. [C]	150	.41.	▶ 40400	41400	.41.12. [C]	412
.16.	▶ 40400	41400	.16.12. [C]	162	.42.	▶ 40400	41400	.42.12. [C]	425
.17.	▶ 40400	41400	.17.12. [C]	175	.43.	▶ 40400	41400	.43.12. [C]	437
.18.	▶ 40400	41400	.18.12. [C]	187	.45.	▶ 40400	41400	.45.12. [C]	450
.20.	▶ 40400/88400	41400/89400	.20.12. [C]	200	.46.	▶ 40400/88400	41400/89400	.46.12. [C]	462
.21.	▶ 40400	41400	.21.12. [C]	212	.47.	▶ 40400	41400	.47.12. [C]	475
.22.	▶ 40400	41400	.22.12. [C]	225	.48.	▶ 40400	41400	.48.12. [C]	487
.23.	▶ 40400	41400	.23.12. [C]	237	.50.	▶ 40400	41400	.50.12. [C]	500
.25.	▶ 40400/88400	41400/89400	.25.12. [C]	250	.51.	▶ 40400	41400	.51.12. [C]	512
.26.	▶ 40400	41400	.26.12. [C]	262	.52.	▶ 40400	41400	.52.12. [C]	525
.27.	▶ 40400/88400	41400/89400	.27.12. [C]	275	.53.	▶ 40400	41400	.53.12. [C]	537
.28.	▶ 40400	41400	.28.12. [C]	287	.55.	▶ 40400	41400	.55.12. [C]	550
.30.	▶ 40400/88400	41400/89400	.30.12. [C]	300	.60.	▶ 40400	41400	.60.12. [C]	600

Full set, for both ends:

40400.[05].[12]

Single-part order:

40400.[05].[1]

Mounting bracket moving end

40400.[05].[2]

Mounting bracket fixed end

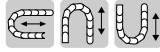

Option steel - pivoting

- For pivoting connections
- One part (two-piece) for all chain widths
- Electrically conductive

Moving end
40400.1

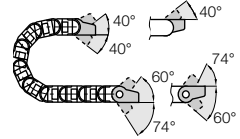

Fixed end
40400.2

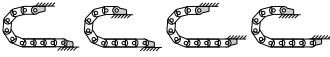

Possible installation conditions -

Further installation angles ► installation sketch

Phone +49- (0) 22 03-96 49-800
Fax +49- (0) 22 03-96 49-222

igus® GmbH
51147 Cologne

Internet: www.igus.eu
E-mail: info@igus.de

Moving end
40400.1

Fixed end
40400.2

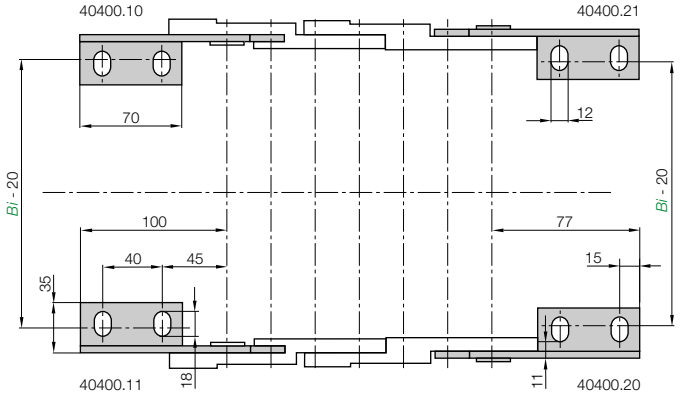

For E-Chain*	Part No. full set	Bi [mm]	For E-Chain*	Part No. full set	Bi [mm]
4040-4140.05	40400.12	50	4040-4140.31	40400.12	312
4040-4140.06	40400.12	65	4040-4140.32	40400.12	325
4040-4140-8840.07	40400.12	75	4040-4140.33	40400.12	337
4040-4140-8840.08	40400.12	87	4040-4140-8840.35	40400.12	350
4040-4140-8840.10	40400.12	100	4040-4140.36	40400.12	362
4040-4140.11	40400.12	112	4040-4140.37	40400.12	375
4040-4140-8840.12	40400.12	125	4040-4140.38	40400.12	387
4040-4140.13	40400.12	137	4040-4140-8840.40	40400.12	400
4040-4140-8840.15	40400.12	150	4040-4140.41	40400.12	412
4040-4140.16	40400.12	162	4040-4140.42	40400.12	425
4040-4140.17	40400.12	175	4040-4140.43	40400.12	437
4040-4140.18	40400.12	187	4040-4140.45	40400.12	450
4040-4140-8840.20	40400.12	200	4040-4140-8840.46	40400.12	462
4040-4140.21	40400.12	212	4040-4140.47	40400.12	475
4040-4140.22	40400.12	225	4040-4140.48	40400.12	487
4040-4140.23	40400.12	237	4040-4140.50	40400.12	500
4040-4140-8840.25	40400.12	250	4040-4140.51	40400.12	512
4040-4140.26	40400.12	262	4040-4140.52	40400.12	525
4040-4140-8840.27	40400.12	275	4040-4140.53	40400.12	537
4040-4140.28	40400.12	287	4040-4140.55	40400.12	550
4040-4140-8840.30	40400.12	300	4040-4140.60	40400.12	600

40400.12 Full set, 4 parts
2 with pin / 2 with bore

Single-part order:

40400.1 Mounting bracket
moving end, 1 part left / right

40400.2 Mounting bracket
fixed end, 1 part left / right

Chainfix clamps for the C-profile

Part No. single clamps		Part No. double clamps		Part No. triple clamps		Cable
steel	stainless steel	steel	stainless steel	steel	stainless steel	ø [mm]
CFX12.1	CFX12.1.E	CFX12.2	CFX12.2.E	CFX12.3	-	06 - 12
CFX14.1	CFX14.1.E	CFX14.2	CFX14.2.E	CFX14.3	-	12 - 14
CFX16.1	CFX16.1.E	CFX16.2	CFX16.2.E	CFX16.3	-	14 - 16
CFX18.1	CFX18.1.E	CFX18.2	CFX18.2.E	CFX18.3	-	16 - 18
CFX20.1	CFX20.1.E	CFX20.2	CFX20.2.E	CFX20.3	-	18 - 20
CFX22.1	CFX22.1.E	CFX22.2	CFX22.2.E	CFX22.3	-	20 - 22
CFX26.1	CFX26.1.E	CFX26.2	CFX26.2.E	-	-	22 - 26
CFX30.1	CFX30.1.E	CFX30.2	CFX30.2.E	-	-	26 - 30
CFX34.1	CFX34.1.E	CFX34.2	CFX34.2.E	-	-	30 - 34
CFX38.1	CFX38.1.E	-	-	-	-	34 - 38
CFX42.1	CFX42.1.E	-	-	-	-	38 - 42

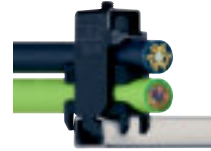

igus® Chainfix steel clamps and Chainfix stainless-steel clamps - max. pull forces, adjustable with hexagon socket. Available as single, double or triple clamps. **Details ▶ chapter 10**

System E4/4
Inner height: 56 mm

Cable ø [mm]	Part No. clamp	Part No. bottom part
04 - 08	CFC-08-M	CFC-08-C
08 - 12	CFC-12-M	CFC-12-C
12 - 16	CFC-16-M	CFC-16-C
16 - 20	CFC-20-M	CFC-20-C
20 - 24	CFC-24-M	CFC-24-C

Chainfix Clip - Modular snap-on strain relief device for C-profile

Available for all igus® E-ChainSystems® with C-profiles and also suitable for assembly in the KMA mounting brackets and clip-on strain relief for crossbars. High pull forces, plug-in modular snap-on strain relief device. **Details ▶ chapter 10**



Part No.	ø max. conduit [mm]	Width [mm]
CFN.20	20	10,8
CFN.30.52	30	16,8
CFN.20.N35	20	20,0

Chainfix Nugget for the C-Profile

Strain relief for the fixation of cables up to a diameter of Ø 30 mm. Easy to assemble, without any screws and tools. Easy strain relief due to fixation with pre-harnessed cable strap, very small space requirement. **Details ▶ chapter 10**



Part No.	Width of strain relief [mm]	Number of teeth
3050.ZC	50	5
3075.ZC	75	7

Chainfix tiwrap plates with clip-on connection for the C-profile

Can be plugged into the KMA C-profile. Easy to assemble without any screws. Easily solvable with screwdriver nevertheless safe stop. For all E-Chains® with KMA and integrated C-profile. **Details ▶ chapter 10**

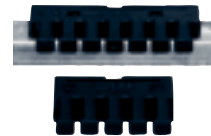

Tiewrap plate	No. of teeth n	Dim. C [mm]	Dim. B [mm]	Center bore
3050.ZB	5	50	30	-
3075.ZB	7	75	55	-
3100.ZB	10	100	80	-
3115.ZB	11	115	95	-
3125.ZB	12	125	105	-
3150.ZB	15	150	130	-
3175.ZB	17	175	155	-
3200.ZB	20	200	180	+
3225.ZB	22	225	205	+
3250.ZB	25	250	230	+

(- = no / + = yes)

Tiewrap plate as individual part

As individual component screwed on KMA. Can be plugged in the mounting brackets. **Details ▶ chapter 10**

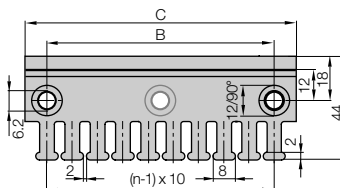

Single tiewrap plate

Shown assembled



▶ page 7.223

- Ba** = Outer width E-Chains® / E-Tube
- Bi** = Inner width E-Chains® / E-Tube
- ha** = Outer height E-Chains® / E-Tube
- H_{Ri}** = Inner trough height
- H_{Ra}** = Outer trough height
- B_{Ri}** = Inner trough width ▶ depends on dim. **Ba**
- B_{Ra}** = Outer trough width
- n_{Mon}** = Number of installation sets (left/right)
- n_{Ri}** = Number of troughs sets (left/right)
- H_{Ri} ≥ 2 • ha**
- B_{Ri} ≥ Ba + 4**
- = Guide trough set ● = Glide bar
- = Installation set "Basic" ● = C-profile

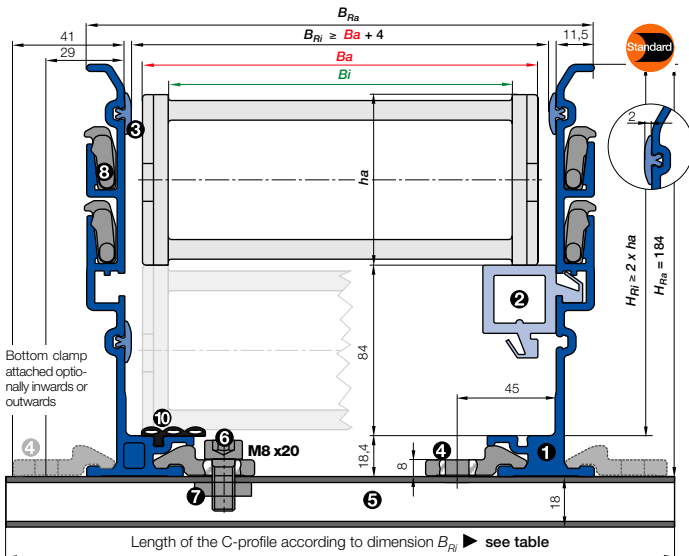

Phone +49- (0) 22 03-96 49-800
Fax +49- (0) 22 03-96 49-222

Installation set "Basic" with C-profile

Bottom Clamp attached optionally inwards or outwards

4040.05.200.0 ▶ Order example

B _{Ri} [mm]	Part No.	
	attached inwards	attached outwards
.05	90	960.50.225
.06	105	960.50.225
.07	115	960.50.250
.08	127	960.50.175
.10	140	960.50.200
.11	153	960.50.200
.12	165	960.50.225
.13	178	960.50.225
.15	190	960.50.250
.16	203	960.50.250
.17	215	960.50.275
.18	228	960.50.275
.20	240	960.50.300
.21	253	960.50.300
.22	265	960.50.325
.23	278	960.50.325
.25	290	960.50.350
.26	303	960.50.350
.27	315	960.50.375
.28	328	960.50.375
.30	340	960.50.400
.31	353	960.50.400
.32	365	960.50.425
.33	378	960.50.425
.35	390	960.50.450
.36	403	960.50.450
.37	415	960.50.475
.38	428	960.50.475
.40	440	960.50.500
.41	453	960.50.500
.42	465	960.50.525
.43	478	960.50.525
.45	490	960.50.550
.46	503	960.50.550
.47	515	960.50.575
.48	528	960.50.575
.50	540	960.50.600
.51	553	960.50.600
.52	565	960.50.625
.53	578	960.50.625
.55	590	960.50.650
.60	640	960.50.700

igus® GmbH
51147 Cologne

Internet: www.igus.eu
E-mail: info@igus.de

- **Components, trough "Basic":** ① Trough side parts, aluminum, 2 m ② Glide bar, plastic, 2 m ③ Glide strips, plastic, 2 m (without glide strips on request) ⑩ Optional: Silencer profile, rubber
- **Components, installation set "Basic":** ④ Bottom clamp, aluminum ⑤ C-profile, steel galvanized ⑥ Screw M8 x20 ⑦ Sliding nut M8 ⑧ Interface connector, plastic



Order example: Length of travel 30 m - Center mounted for Series 4040.10.200.0 with B_{Ri} = 140

- Guide trough set (set of 2 trough side parts, incl. glide strips) **without** glide bar
Order text: 16 m guide trough without glide bar (8 x 2 m sections) **Part No. 974.30.SL**
- Guide trough set (set of 2 trough side parts, incl. glide strips) **with** glide bar
Order text: 16 m guide trough with glide bar (8 x 2 m sections) **Part No. 974.31.SL**
- Installation set "Basic" complete (guide trough-sets + 1)
Order text: 17 installation sets "Basic" **Part No. 960.50.200**
- Module for the fixed end
Order text: 1 set **Part No. 974.80**
- Option:** For an additional noise dampening with silencer profile, please add Index A - Example: **Part No. 974.30.SLA**

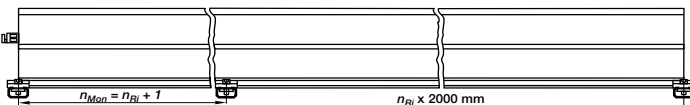

Principle sketch: Number of installation sets to be installed = Number of trough sections + 1

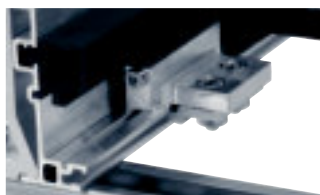

A quick fix for mounting the stationary end of an E-Chain®
With this module for the fixed end, fast and easy mounting onto the Aluminum "SuperTrough" is now possible without any drilling. Fast mounting of the E-Chain® by clamping onto the aluminum trough
● Quick relocation of the stationary end ● No drilling necessary ▶ [page 9.16](#)



The maintenance-free Serie 4040 protects the igus® Chainflex® motor and signal cables during the lifting and lowering movements of the tidal turbine and also protects them against aggressive ambient conditions. The travel distance amounts to approx. 20 m in vertical direction above and under water



Series 4040AX

Special E-Chains® for fine dust applications

For long travel applications and fine dust applications, we have developed a special E-ChainSystem® with exterior, dirt-repellent stop dogs.

- Exterior stop dogs prevent the settling of dust, dirt, chips, flour, etc.
- Mounting brackets and accessories from the serie 4040

Series 4040AX - Order example: 4040AX.30.250.0

Further information: igus.de/en/4040AX or phone +49-0 22 03-96 49-800

System E4/4
Inner height: 56 mm

Phone +49- (0) 22 03-96 49-800
Fax +49- (0) 22 03-96 49-222



▶ Chapter 9



▶ page 7.223

Price index



Series 4040HD Series R8840HD



"Heavy-Duty" version
for long travel applications



ESD classification:
Electrically conductive ESD/ATEX
version upon request



Very high torsional rigidity
and and tensile force



Opening E-Chains: Remove crossbars and clips - Insert screwdriver into the slot, push down, release by lever action



Remove lids/bottoms (E-Tubes) - Insert screwdriver into the slot, release by lever action



When to use the Series 4040HD/R8840HD:

- For high (tensile-)charges at long travel applications
- When high torsional forces are expected
- For long-term operation in very moist environments
- Also available as Rol E-Chain*



When not to use them:

- If a quieter version is required
▶ Series E4.56, page 7.62
- If a simple and low-cost solution is required
▶ Series 14040/R18840, page 7.124

- ❶ High side-mount stability due to undercut
- ❷ High torsional rigidity
- ❸ High tensile stability (20% higher tensile force than Series 4040)
- ❹ Very wide gliding surface, less wear
- ❺ Closed and open styles can be combined
- ❻ Hinged snap-open removable lids along outer radius of E-Tube
- ❼ Numerous interior separation possibilities
- ❽ Crossbars are removable along both radii
- ❾ Wide, rounded plastic crossbars - cable friendly
- ❿ Robust Steel-Mounting Brackets



Rol E-Chain® Series 4040RHHD and R8840RHHD available upon request



Order example complete E-Chain®

Please indicate chain-lengths or number of links Example: 5 m or 55 links

5 m 4040HD.30.300.0

E-Chain®

with 2 separators 411 assembled every 2nd link

Interior separation

1 set 4040HD.12.E

Mounting bracket



Unsupported length

FL_G = with straight upper run

FL_B = with permitted sag

Further information ► **Design, page 1.12**

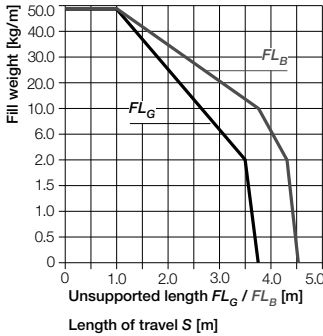
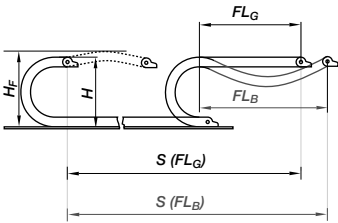

- S = Length of travel
 - R = Bending radius
 - H = Nominal clearance height
 - H_F = Required clearance height
 - H_{R1} = Trough inner height
 - D = Overlength E-Chain® radius in final position
 - $K = \pi \cdot R + \text{"safety"}$
 - D_2 = Over length - long travels, gliding
 - K_2 = *Further add-on
 - H_2 = *Mounting height
- *if the mounting bracket location is set lower

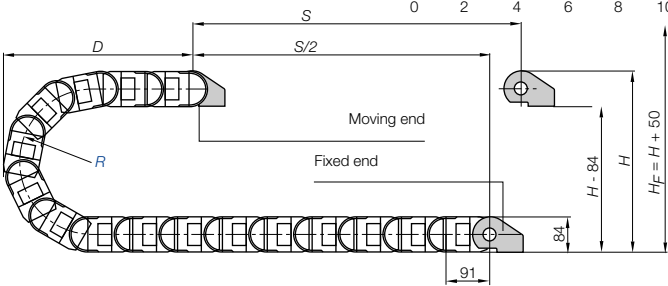

Pitch = 91 mm/Glided Links/m = 11 (1001 mm) Chain length = $S/2 + K$

R	135	150	250	300
H	354	384	584	684
D	268	283	383	433
K	610	655	970	1125
H_2	266	266	266	266
D_2	390	450	920	1180
K_2	728	819	1638	2002



Short travels - unsupported

Unsupported E-Chains® feature positive camber over short travels. This must be accounted for when specifying the clearance height H_F . Please consult igus® if space is particularly restricted.

The required clearance height:
 $H_F = H + 50$ mm
(with 3,0 kg/m fill weight)

Long travel lengths from 10 m to max. 350 m Chain length = $S/2 + K_2$

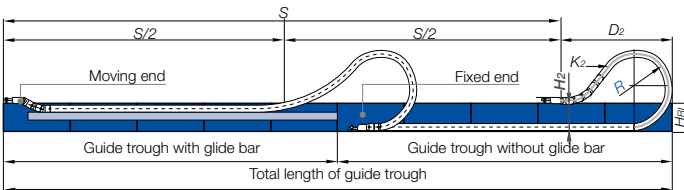

In case of travels between 4 and 10 m we recommend a longer unsupported length.



Gliding, long travel applications (max. 350 m)

In this case the E-Chain® upper run will be introduced in a guide trough on the lower run. We recommend to realize the engineering of such a plant by our technicians.

Speed / acceleration FL_G	max. 20 [m/s] / max. 200 [m/s²]
Speed / acceleration FL_B	max. 3 [m/s] / max. 6 [m/s²]
Gliding speed / acceleration (maximum)	max. 10 [m/s] / max. 50 [m/s²]
Material - permitted temperature °C	igumid G / -40° up to +120° C
Flammability class, igumid G	VDE 0304 IIC UL94 HB

Technical Data



Details of material properties
► **page 1.38**



System E4/4
Inner height: 56 mm

Phone +49- (0) 22 03-96 49-800
Fax +49- (0) 22 03-96 49-222

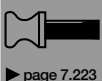

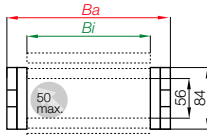

Part No. structure

4040HD. 30. 250. 0



Series 4040HD - E-Chain® with crossbars every link

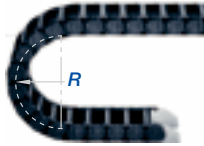

- Crossbars every link
- For highest additional loads
- For applications particularly demanding
- Can be opened from two sides



Phone+49- (0) 22 03-96 49-800
Fax +49- (0) 22 03-96 49-222

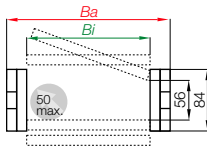

Part No. structure

8840HD. 30. 250. 0



Series R8840HD - Fully enclosed E-Tube

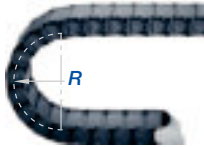

- Fully enclosed
- Excellent cable protection against dirt
- Protection against hot chips
- Lids along the entire inner radius are completely removable. Lids along the entire outer radius are single sided snap-open with a hinge on the other side to keep them attached to the chain or completely removable



igus® GmbH
51147 Cologne

Internet: www.igus.eu
E-mail: info@igus.de

Roll instead of gliding: Rol E-Chain®

Special solution for long travels. 75% less drive power (gliding application) with igus® Rol E-Chain®.
Series 4040R - Order example 4040RHD.30.250.0
Further information: www.igus.de/en/role
or phone: +49-0 22 03-96 49-800



Part No.		<i>Bi</i>	<i>Ba</i>	4040HD	R8840HD
		[mm]	[mm]	[kg/m]	[kg/m]
4040HD.05.	<input type="checkbox"/> .0	50	104	≈ 5,03	-
4040HD.06.	<input type="checkbox"/> .0	65	119	≈ 5,12	-
4040HD/8840HD.07.	<input type="checkbox"/> .0*	75	129	≈ 5,19	≈ 5,64
4040HD.08.	<input type="checkbox"/> .0	87	141	≈ 5,27	-
4040HD/8840HD.10.	<input type="checkbox"/> .0	100	154	≈ 5,36	≈ 5,93
4040HD.11.	<input type="checkbox"/> .0	112	166	≈ 5,48	-
4040HD/8840HD.12.	<input type="checkbox"/> .0	125	179	≈ 5,56	≈ 6,29
4040HD.13.	<input type="checkbox"/> .0	137	191	≈ 5,69	-
4040HD/8840HD.15.	<input type="checkbox"/> .0	150	204	≈ 5,73	≈ 6,67
4040HD.16.	<input type="checkbox"/> .0	162	216	≈ 5,84	-
4040HD.17.	<input type="checkbox"/> .0	175	229	≈ 5,97	-
4040HD.18.	<input type="checkbox"/> .0	187	241	≈ 6,09	-
4040HD/8840HD.20.	<input type="checkbox"/> .0	200	254	≈ 6,14	≈ 7,29
4040HD.21.	<input type="checkbox"/> .0	212	266	≈ 6,21	-
4040HD.22.	<input type="checkbox"/> .0	225	279	≈ 6,28	-
4040HD.23.	<input type="checkbox"/> .0	237	291	≈ 6,39	-
4040HD/8840HD.25.	<input type="checkbox"/> .0	250	304	≈ 6,50	≈ 8,02
4040HD.26.	<input type="checkbox"/> .0	262	316	≈ 6,59	-
4040HD/8840HD.27.	<input type="checkbox"/> .0	275	329	≈ 6,70	≈ 8,38
4040HD.28.	<input type="checkbox"/> .0	287	341	≈ 6,75	-
4040HD/8840HD.30.	<input type="checkbox"/> .0	300	354	≈ 6,91	≈ 8,68
4040HD.31.	<input type="checkbox"/> .0	312	366	≈ 6,94	-
4040HD.32.	<input type="checkbox"/> .0	325	379	≈ 7,05	-
4040HD.33.	<input type="checkbox"/> .0	337	391	≈ 7,17	-
4040HD/8840HD.35.	<input type="checkbox"/> .0	350	404	≈ 7,37	≈ 9,38
4040HD.36.	<input type="checkbox"/> .0	362	416	≈ 7,28	-
4040HD.37.	<input type="checkbox"/> .0	375	429	≈ 7,38	-
4040HD.38.	<input type="checkbox"/> .0	387	441	≈ 7,49	-
4040HD/8840HD.40.	<input type="checkbox"/> .0	400	454	≈ 7,76	≈ 10,38
4040HD.41.	<input type="checkbox"/> .0	412	466	≈ 7,68	-
4040HD.42.	<input type="checkbox"/> .0	425	479	≈ 7,98	-
4040HD.43.	<input type="checkbox"/> .0	437	491	≈ 7,82	-
4040HD.45.	<input type="checkbox"/> .0	450	504	≈ 8,15	-
4040HD/8840HD.46.	<input type="checkbox"/> .0	462	516	≈ 8,10	≈ 10,85
4040HD.47.	<input type="checkbox"/> .0	475	529	≈ 8,14	-
4040HD.48.	<input type="checkbox"/> .0	487	541	≈ 8,39	-
4040HD.50.	<input type="checkbox"/> .0	500	554	≈ 8,48	-
4040HD.51.	<input type="checkbox"/> .0	512	566	≈ 8,40	-
4040HD.52.	<input type="checkbox"/> .0	525	579	≈ 8,57	-
4040HD.53.	<input type="checkbox"/> .0	537	591	≈ 8,66	-
4040HD.55.	<input type="checkbox"/> .0	550	604	≈ 9,08	-
4040HD.60.	<input type="checkbox"/> .0	600	654	≈ 9,31	-

Available bending radii

R [mm] 135** 150 250 300

Supplement Part No. with required radius. Example: 4040HD.30.300.0

0 = standard color, other colors ▶ page 1.39 • Pitch = 91 mm/link • Links/m = 11

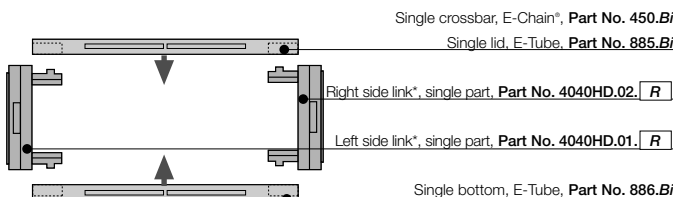

Hot Chips up to 850°C

E-Tubes that repel hot chips, up to 850°C. Some applications, depending on amount and size of the chips, can burn or melt the surface. That is no longer the case with the igus® "igumid HT" material. Order example: Full E-Tube made of HT: **8840HD.40.150.0.HT**
Lids made of HT: **8840HD.40.HTE.150.0**

*for long travels. Upon request
Further Information: www.igus.de/en/HT
Delivery time up to 4 weeks!



System E4/4
Inner height: 56 mm

Phone +49- (0) 22 03-96 49-800
Fax +49- (0) 22 03-96 49-222



* Removable lid only, no hinged option

** not available for R8840HD



Extender crossbar for large diameter hoses ▶ page 7.254

Part No. E-Chain® - links, single parts

*View from the fixed point of the E-Chain®/E-Tube



▶ page 7.223



Vertical separators are used if a vertical subdivision is required. In the standard configuration, a separator is mounted at every second link. **Note:** Observe a lateral spacing of at least 33 mm (E-Tube) and 16 mm (E-Chain)!

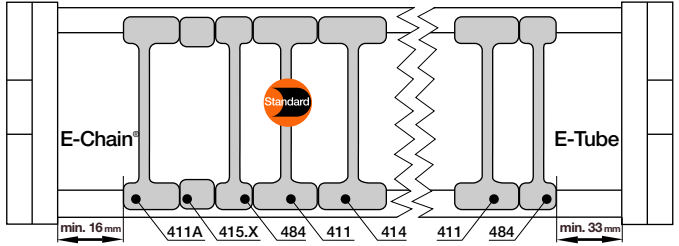

Vertical separator
401



Vertical separator
483



Spacer
405.XX



Locking separator
404



Vertical separator
406



Asymmetric
separator 401A



Vertical separator for E-Chains®/E-Tubes	
unassembled	401
assembled	411



Vertical separator for E-Chains®/E-Tubes	
unassembled	483
assembled	484



Spacer® for E-Chains®	
unassembled	405.XX
assembled	415.XX



Locking separator for E-Chains®	
unassembled	404
assembled	414



Vertical separator for E-Tubes	
unassembled	406
assembled	416



Asymmetric separator for E-Chains®	
unassembled	401A
assembled	411A



*For side-mounted applications

Option 1: Vertical separators and spacers

● **Standard separator 401** for E-Chains®/E-Tubes offers safe stability due to its broad foot design, also when used with thick cables or hoses.

● **Vertical separator 483** with a narrow foot for E-Chains® and E-Tubes with applications where a large number of small cables need to be individually separated.

● Separators (e.g. "side mounted") for E-Chains® can be fixed in their position with **Spacers 405.XX**. The available inner height will be reduced by 2 mm, per spacer and side. To avoid this, the parts can be assembled on outside of the crossbar (not for long travels) **XX = width of the spacer** (available 10, 15, 20, 30 and 40 mm)

Additionally:

● **Locking separator for E-Chains® 404** - with increased retention force for applications exposed to very high humidity or extreme loads. The extra retention force is achieved by asymmetric claws for the crossbar. Ensure proper alignment

● **Locking separator 406** for E4-Tubes - safe fitting locked on lid or bottom of the Tube and sideways slideable. The opposing lid or bottom can easily be opened and closed. Especially capable if many separators need to be assembled on a tight inner width

● **Asymmetric separator 401A** for E-Chains® with an 18-mm base, for combinations between spacers of different widths and vertical separators in side-mounted applications, for instance.

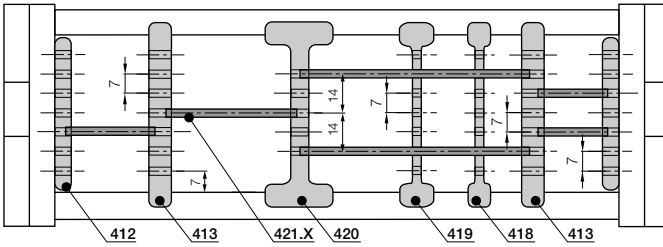

For use with many cables of differing diameters. E-Chains® and E-Tubes can be subdivided both vertically and horizontally. The shelves can be arranged elevator-shifted with different bottoms

Option 2: Shelves

● Side plates 402, middle plates 403 and shelves 420.X form the basic pattern of a shelf system. Shelves of various widths can be arranged at 7 different heights (in 7 mm increments).

● Locking vertical separator 410, slotted combined with shelves (only for E-Chains®).

● Slotted separators 408 are used for very fine subdivisions. However, they cannot be retrofitted into an existing separation system without dismantling the interior separators first.

● The unilateral open slotted separator 409 can be retrofitted into an existing interior separation system without a need for dismantling the interior separators. During an installation of open slotted separators, the top and bottom notches cannot be occupied by shelves.

Side plate for E-Chains®/E-Tubes	
unassembled	402
assembled	412

Middle plate for E-Chains®/E-Tubes	
unassembled	403
assembled	413

Locking vertical separator for E-Chains®	
unassembled	410
assembled	420

Slotted separator for E-Chains®/E-Tubes	
unassembled	408
assembled	418

Open slotted separator for E-Chains®/E-Tubes	
unassembled	409
assembled	419

Width X [mm]	Part No. unassembled	Part No. assembled
018	420.18	421.18
023	420.23	421.23
025	420.25	421.25
028	420.28	421.28
033	420.33	421.33
043	420.43	421.43
050	420.50	421.50
062	420.62	421.62

Width X [mm]	Part No. unassembled	Part No. assembled
075	420.75	421.75
088	420.88	421.88
100	420.100	421.100
125	420.125	421.125
150	420.150	421.150
175	420.175	421.175
187	420.187	421.187
200	420.200	421.200

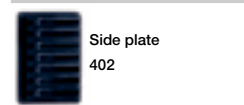

Side plate
402

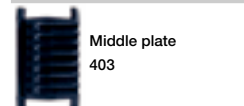

Middle plate
403



Locking vertical
separator
410



Slotted
separator
408

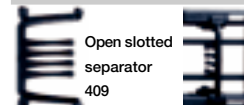

Open slotted
separator
409



Shelf 420.X

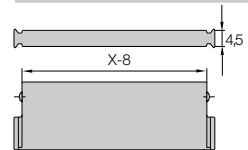

Additional elements for interior separation

Center crossbar	
unassembled	405
assembled	415

Center crossbar - was developed for applications with a large number of thin cables. The center crossbar offers the option of subdividing the E-Chain® independently into upper and lower halves.

Rollclip	
unassembled	489.27
assembled	490.27

Rollclip - minimizes abrasion of particularly sensitive hoses. The Rollclip is simply clamped onto the opening crossbar. The movable rollers compensate for relative movement between the chain and hose.

Roller separator	
unassembled	429
assembled	430

Roller separator - performs a similar function to the Rollclip, but doubles as a separator.

System E4/4
Inner height: 56 mm

Phone +49- (0) 22 03-96 49-800
Fax +49- (0) 22 03-96 49-222



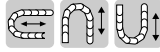

Option steel - pivoting

- For pivoting connections
- One part (two-piece) for all chain widths
- Electrically conductive

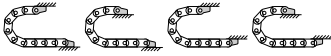

Possible installation conditions -

Further installation angles ► installation sketch

Moving end
40400HD.1.E

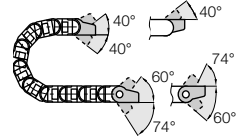

Fixed end
40400HD.2.E

Phone +49- (0) 22 03-96 49-800
Fax +49- (0) 22 03-96 49-222

igus® GmbH
51147 Cologne

Moving end
40400HD.1.E

Fixed end
40400HD.2.E

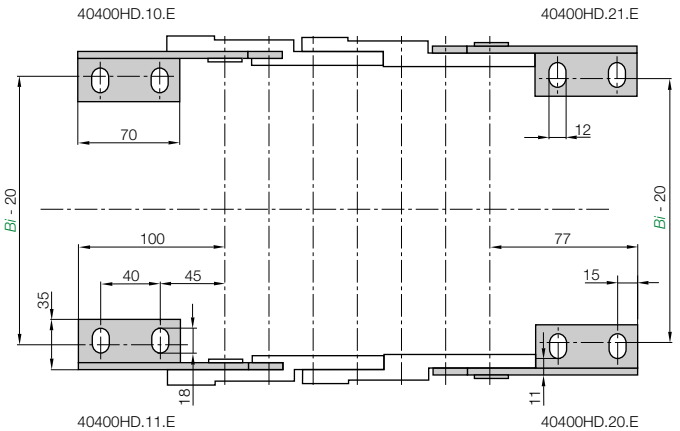

Part No.	Mounting bracket
40400HD.12.E	Full set, 4 parts, 2 with pin / 2 with bore
40400HD.1.E	Mounting bracket moving end, 1 part left / right
40400HD.2.E	Mounting bracket fixed end, 1 part left / right

E4/4 | Series 4040HD-R8840HD | Accessories | Strain Relief

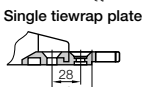
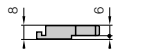

Shown assembled

Tiewrap plate as individual part

As individual component screwed on KMA. Can be plugged in the mounting brackets. **Details ► chapter 10**

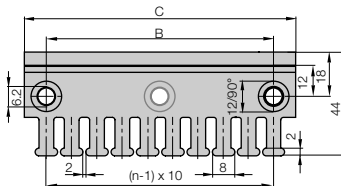

Tiewrap plate	No. of teeth n	Dim. C [mm]	Dim. B [mm]	Center bore
3050.ZB	5	50	30	-
3075.ZB	7	75	55	-
3100.ZB	10	100	80	-
3115.ZB	11	115	95	-
3125.ZB	12	125	105	-
3150.ZB	15	150	130	-
3175.ZB	17	175	155	-
3200.ZB	20	200	180	+
3225.ZB	22	225	205	+
3250.ZB	25	250	230	+

(- = no / + = yes)

Internet: www.igus.eu
E-mail: info@igus.de

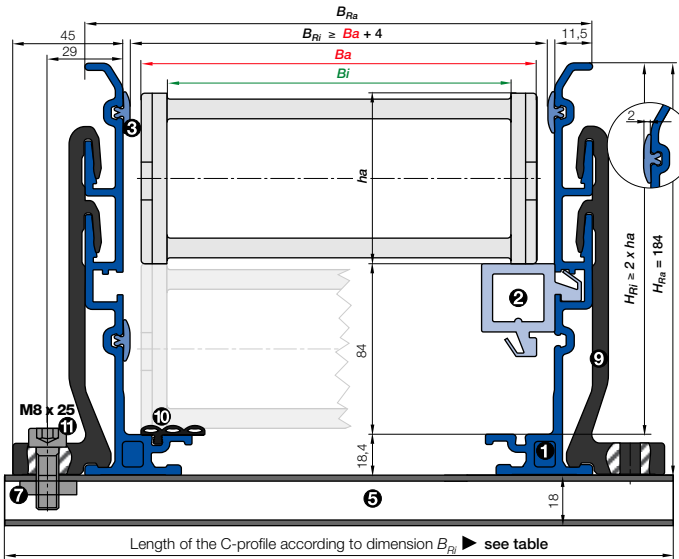

- B_a = Outer width E-Chains® / E-Tube
- B_i = Inner width E-Chains® / E-Tube
- h_a = Outer height E-Chains® / E-Tube
- H_{Ri} = Inner trough height
- H_{Ra} = Outer trough height
- B_{Mon} = Inner trough width ▶ depends on dim. B_a
- B_{Ra} = Outer trough width
- n_{Mon} = Number of installation sets (left/right)
- n_{Ri} = Number of trough sets (left/right)
- $H_{Ri} \geq 2 \cdot h_a$
- $B_{Ri} \geq B_a + 4$
- = Guide trough set ● = Glide bar
- = Installation set "Basic" ● = C-profile

Installation set Heavy-Duty with C-profile

4040HD.05.250.0 ▶ Order example

B_{Ri} [mm]	Part No. assembled
.05	108 974.50.225
.06	123 974.50.250
.07	133 974.50.250
.08	145 974.50.275
.10	158 974.50.275
.11	170 974.50.300
.12	183 974.50.300
.13	195 974.50.325
.15	208 974.50.325
.16	220 974.50.350
.17	233 974.50.350
.18	245 974.50.375
.20	258 974.50.375
.21	270 974.50.400
.22	283 974.50.400
.23	295 974.50.425
.25	308 974.50.425
.26	320 974.50.450
.27	333 974.50.450
.28	345 974.50.475
.30	358 974.50.475
.31	370 974.50.500
.32	383 974.50.500
.33	395 974.50.525
.35	408 974.50.525
.36	420 974.50.550
.37	433 974.50.550
.38	445 974.50.575
.40	458 974.50.575
.41	470 974.50.600
.42	483 974.50.600
.43	495 974.50.625
.45	508 974.50.625
.46	520 974.50.650
.47	533 974.50.650
.48	545 974.50.675
.50.^\	558 974.50.675
.51	570 974.50.700
.52	583 974.50.700
.53	595 974.50.725
.55	608 974.50.725
.60	658 974.50.775



- **Components, trough "Heavy Duty":** ① Trough side parts, aluminum, 2 m ② Glide bar, plastic, 2 m ③ Glide strips, plastic, 2 m (without glide strips on request) ⑩ Optional: Silencer profile, rubber
- **Components, installation set "Heavy Duty":** ⑤ C-profile, steel galvanized ⑦ Sliding nut M8 ⑨ Installation angle bracket "Heavy Duty", Aluminium ⑪ Screw M8 x 25

Order example: Length of travel 30 m - Center mounted for Series 4040HD.10.250.0 with $B_{Ri} = 158$

- Guide trough set (set of 2 trough side parts, incl. glide strips) **without** glide bar
Order text: 16 m guide trough without glide bar (8 x 2 m sections) **Part No. 974.30.SL**
- Guide trough set (set of 2 trough side parts, incl. glide strips) **with** glide bar
Order text: 16 m guide trough with glide bar (8 x 2 m sections) **Part No. 974.31.SL**
- Installation set "Basic" complete (guide trough-sets + 1)
Order text: 17 installation sets "Basic" **Part No. 974.50.275**
- Option: For an additional noise dampening with silencer profile, please add Index A - Example: **Part No. 974.30.SLA**

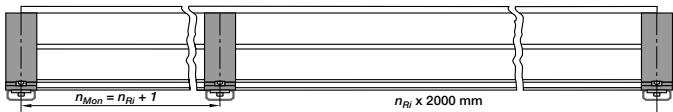

Principle sketch: Number of installation sets to be installed = **Number of trough sections + 1**

Phone +49- (0) 22 03-96 49-800
Fax +49- (0) 22 03-96 49-222

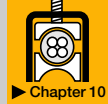
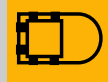

Price index

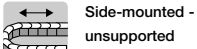

Side-mounted - unsupported



ESD classification:
Electrically conductive ESD/ATEX version upon request



High torsional rigidity



Opening E-Chains: Remove crossbars and clips - Insert screwdriver into the slot, push down, release by lever action



Remove lids/bottoms (E-Tubes) - Insert screwdriver into the slot, release by lever action



When to use the Series 5050/5150/R9850:

- When high torsional forces are expected
- For side-mounted applications involving large unsupported lengths
- Due to very dirt and dusty environment
- Also available as Rol E-Chain®



When not to use it:

- When very long travels or high additional loads are involved
▶ Series 5050HD, page 7.268
- If a simple and low-cost solution is required
▶ Series 15050/R19850, page 7.144

- 1 High side-mount stability due to undercut
- 2 High torsional rigidity
- 3 Closed and open styles can be combined
- 4 Hinged snap-open removable lids of E-Tube
- 5 Numerous interior separation possibilities
- 6 Crossbars on E-Chains® are removable along both radii
- 7 Lateral glide surfaces for side-mounted operation
- 8 Wide, rounded plastic crossbars - cable friendly
- 9 KMA mounting brackets with attachment points on all sides
- 10 Mounting brackets with integrated strain relief available, locking or pivoting
- 11 E-Chains® also available with reverse bending radius "RBR"

! "Heavy-Duty" size available. Greater unsupported length for higher loads and travels. Also available as Rol E-Chain® version



Rol E-Chain® Series 5050R/9850R available upon request

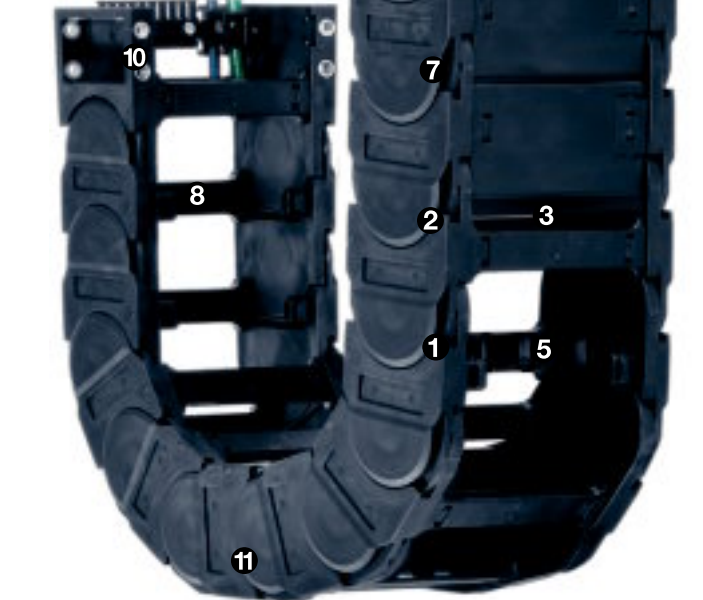

Order example complete E-Chain®

Please indicate chain-lengths or number of links Example: 5 m or 55 links

5 m 5050.30.300.0

E-Chain®

with 2 separators 511 assembled every 2nd link

Interior separation

1 set 50500.30.12C

Mounting bracket



Unsupported length

FL_G = with straight upper run

FL_B = with permitted sag

Further information ► **Design, page 1.12**

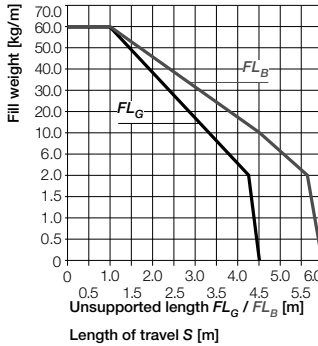
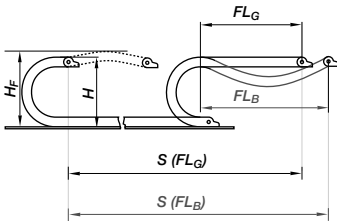

- S = Length of travel
 - R = Bending radius
 - H = Nominal clearance height
 - H_F = Required clearance height
 - H_{R1} = Trough inner height
 - D = Overlength E-Chain® radius in final position
 - $K = \pi \cdot R + \text{"safety"}$
 - D_2 = Over length - long travels, gliding
 - K_2 = *Further add-on
 - H_2 = *Mounting height
- *if the mounting bracket location is set lower

Other installation methods

- Vertical, hanging ≤ 120 m
- Vertical, standing ≤ 6 m
- Side mounted, un supp. ≤ 3 m
- Rotary requires further calculation
- Unsupported length of upper run = upon request

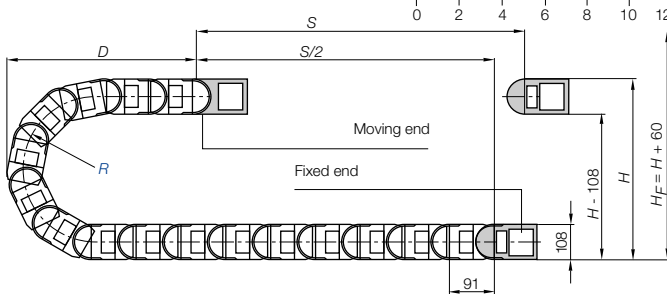

Pitch = 91 mm/link Links/m = 11 (1001 mm) Chain length = $S/2 + K$

R	150	200	250	300	350	400	500	550	600	650	1000
H_{25}	408	508	608	708	808	908	1108	1208	1308	1408	2108
D	295	345	395	445	495	545	645	695	745	795	1145
K	655	815	970	1125	1285	1440	1755	1910	2070	2225	3255
H_2	242	242	242	242	242	242	242	242	242	-	-
D_{25}	550	800	950	1200	1550	1700	2175	2355	2580	-	-
K_2	910	1274	1638	2002	2457	2730	3458	3640	4459	-	-

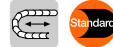

Short travels - unsupported

Unsupported E-Chains® feature positive camber over short travels. This must be accounted for when specifying the clearance height H_F . Please consult igus® if space is particularly restricted.

The required clearance height:

$H_F = H + 60$ mm
(with 3,0 kg/m fill weight)

Long travel lengths from 10 m to max. 400 m Chain length = $S/2 + K_2$

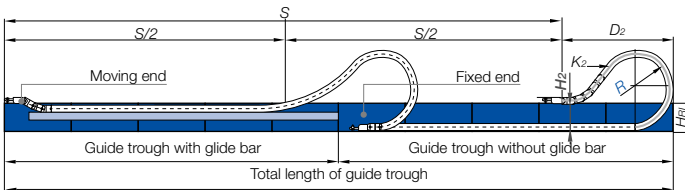

In case of travels between 4 and 10 m we recommend a longer unsupported length.



Gliding, long travel applications (max. 400 m)

In this case the E-Chain® upper run will be introduced in a guide trough on the lower run. We recommend to realize the engineering of such a plant by our technicians.

Technical Data

Speed / acceleration FL_G	max. 20 [m/s] / max. 200 [m/s²]
Speed / acceleration FL_B	max. 3 [m/s] / max. 6 [m/s²]
Gliding speed / acceleration (maximum)	max. 10 [m/s] / max. 50 [m/s²]
Material - permitted temperature °C	igumid G / -40° up to +120° C
Flammability class, igumid G	VDE 0304 IIC UL94 HB



Details of material properties
► page 1.38



System E4/4
Inner height: 80 mm

Phone +49- (0) 22 03-96 49-800
Fax +49- (0) 22 03-96 49-222



► page 7.223

For support of the lower run - **Support Tray tool kit** available ► page 9.70

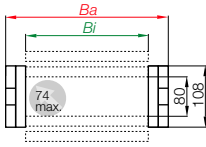

Part No. structure

5050. 30. 300. 0



Series 5050 - E-Chain® with crossbars every link

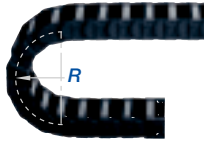

- Crossbars every link
- For rigid hydraulic hoses
- For applications particularly demanding
- Can be opened from two sides

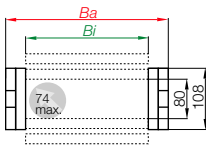

Part No. structure

5150. 30. 300. 0



Series 5150 - E-Chain® with crossbars every 2nd link

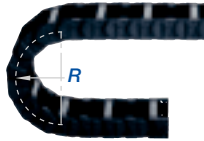

- Crossbars every 2nd link = Standard
- For nearly every situation
- Can be opened from two sides
- Easy assembly
- Stable
- Attractive price

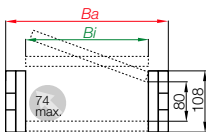

Part No. structure

9850. 30. 300. 0



Series R9850 - Fully enclosed E-Tube

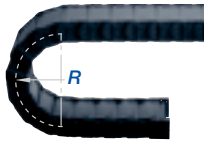

- Fully enclosed
- Excellent cable protection against dirt
- Protection against hot chips (up to 900°C)
- Lids along the entire inner radius are completely removable. Lids along the entire outer radius are single sided snap-open with a hinge on the other side to keep them attached to the chain or completely removable.



Rol instead of gliding: Rol E-Chain®

Special solution for long travels. 75% less drive power (gliding application) with igus® Rol E-Chain®.
Series 5050R and 9850R - Order example 5050R.30.300.0
Further information: www.igus.de/en/role
or phone: +49-0 22 03-96 49-800



Part No.		Bi [mm]	Ba [mm]	5050 [kg/m]	5150 [kg/m]	R9850 [kg/m]
5050/5150.05.	<input type="checkbox"/>	50	100	≈ 5,63	≈ 5,62	-
5050/5150.06.	<input type="checkbox"/>	65	115	≈ 5,70	≈ 5,68	-
5050/5150/9850.07.	<input type="checkbox"/>	75	125	≈ 5,79	≈ 5,70	≈ 6,24
5050/5150.08.	<input type="checkbox"/>	87	137	≈ 5,89	≈ 5,76	-
5050/5150/9850.10.	<input type="checkbox"/>	100	150	≈ 5,96	≈ 5,79	≈ 6,52
5050/5150.11.	<input type="checkbox"/>	112	163	≈ 6,09	≈ 5,85	-
5050/5150/9850.12.	<input type="checkbox"/>	125	175	≈ 6,16	≈ 5,89	≈ 6,89
5050/5150.13.	<input type="checkbox"/>	137	188	≈ 6,29	≈ 5,95	-
5050/5150/9850.15.	<input type="checkbox"/>	150	200	≈ 6,36	≈ 5,98	≈ 7,32
5050/5150.16.	<input type="checkbox"/>	162	213	≈ 6,47	≈ 6,04	-
5050/5150.17.	<input type="checkbox"/>	175	225	≈ 6,58	≈ 6,09	-
5050/5150.18.	<input type="checkbox"/>	187	238	≈ 6,69	≈ 6,15	-
5050/5150/9850.20.	<input type="checkbox"/>	200	250	≈ 6,71	≈ 6,16	≈ 7,89
5050/5150.21.	<input type="checkbox"/>	212	263	≈ 6,82	≈ 6,22	-
5050/5150.22.	<input type="checkbox"/>	225	275	≈ 6,89	≈ 6,25	-
5050/5150.23.	<input type="checkbox"/>	237	288	≈ 7,02	≈ 6,31	-
5050/5150/9850.25.	<input type="checkbox"/>	250	300	≈ 7,11	≈ 6,36	≈ 8,61
5050/5150.26.	<input type="checkbox"/>	262	313	≈ 7,19	≈ 6,40	-
5050/5150/9850.27.	<input type="checkbox"/>	275	325	≈ 7,30	≈ 6,46	≈ 8,82
5050/5150.28.	<input type="checkbox"/>	287	338	≈ 7,33	≈ 6,47	-
5050/5150/9850.30.	<input type="checkbox"/>	300	350	≈ 7,55	≈ 6,58	≈ 9,27
5050/5150.31.	<input type="checkbox"/>	312	363	≈ 7,58	≈ 6,60	-
5050/5150.32.	<input type="checkbox"/>	325	375	≈ 7,63	≈ 6,62	-
5050/5150.33.	<input type="checkbox"/>	337	388	≈ 7,81	≈ 6,71	-
5050/5150/9850.35.	<input type="checkbox"/>	350	400	≈ 7,96	≈ 6,79	≈ 10,02
5050/5150.36.	<input type="checkbox"/>	362	413	≈ 7,97	≈ 6,80	-
5050/5150.37.	<input type="checkbox"/>	375	425	≈ 7,99	≈ 6,80	-
5050/5150.38.	<input type="checkbox"/>	387	438	≈ 8,07	≈ 6,84	-
5050/5150/9850.40.	<input type="checkbox"/>	400	450	≈ 8,27	≈ 6,94	≈ 10,98
5050/5150.41.	<input type="checkbox"/>	412	463	≈ 8,43	≈ 7,02	-
5050/5150.42.	<input type="checkbox"/>	425	475	≈ 8,58	≈ 7,10	-
5050/5150.43.	<input type="checkbox"/>	437	488	≈ 8,65	≈ 7,13	-
5050/5150.45.	<input type="checkbox"/>	450	500	≈ 8,71	≈ 7,16	-
5050/5150/9850.46.	<input type="checkbox"/>	462	513	≈ 8,73	≈ 7,17	≈ 11,44
5050/5150.47.	<input type="checkbox"/>	475	525	≈ 8,87	≈ 7,24	-
5050/5150.48.	<input type="checkbox"/>	487	538	≈ 8,88	≈ 7,26	-
5050/5150.50.	<input type="checkbox"/>	500	550	≈ 9,00	≈ 7,30	-
5050/5150.51.	<input type="checkbox"/>	512	563	≈ 9,02	≈ 7,32	-
5050/5150.52.	<input type="checkbox"/>	525	575	≈ 9,06	≈ 7,34	-
5050/5150.53.	<input type="checkbox"/>	537	588	≈ 9,22	≈ 7,41	-
5050/5150.55.	<input type="checkbox"/>	550	600	≈ 9,70	≈ 7,66	-
5050/5150.60.	<input type="checkbox"/>	600	650	≈ 9,90	≈ 7,76	-

Available bending radii

R [mm] 150* 200 250 300 350 400 500 550 600 650 1000

Supplement Part No. with required radius. Example: 5050.30.300.0

0 = standard color, other colors ▶ page 1.39 · Pitch = 91 mm/link · Links/m = 11

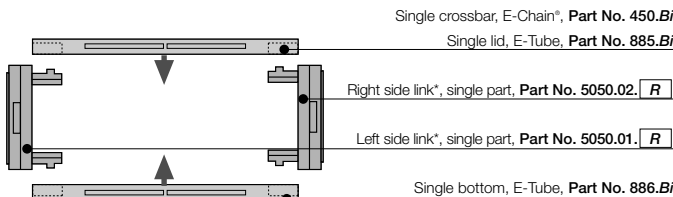

Hot Chips up to 850°C

E-Tubes that repel hot chips, up to 850°C. Some applications, depending on amount and size of the chips, can burn or melt the surface. That is no longer the case with the igus® "igumid HT" material. Order excuse!

Full E-Tube made of HT:
9850.40.250.0.HT
Lids made of HT:
9850.40.HTE.250.0

*for long travels. Upon request
Further information:
www.igus.de/en/HT
Delivery time
up to 4 weeks!

Extreme Glider..

...with up to 70% larger glide surface. For high additional loads and high gliding speeds. Gliding applications without additional elements as well as 150% more wear allowance and improvement of service life by factor 4!

Order example:
5050.35G.250.0
5050.45G.250.0
Further information:
phone +49-0 22 03-96 49-800



*not available for R9850



Extender crossbar for large diameter hoses ▶ page 7.274

Part No. E-Chain® - links, single parts

*View from the fixed point of the E-Chain®/E-Tube

System E4/4
Inner height: 80 mm

Phone +49- (0) 22 03-96 49-800
Fax +49- (0) 22 03-96 49-222



▶ page 7.223



Vertical separators are used if a vertical subdivision is required. In the standard configuration, a separator is mounted at every second link. **Note:** Observe a lateral spacing of at least 33 mm (E-Tube) and 16 mm (E-Chain)!

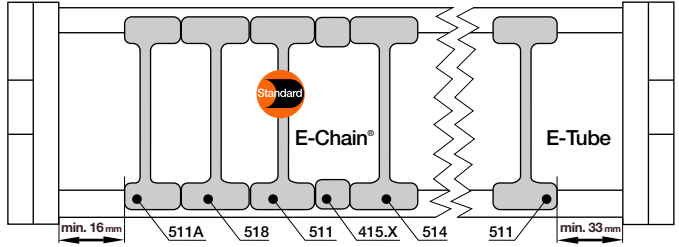

Vertical separator
501



Spacer
405.XX



Locking separator
504



Locking separator
508



Asymmetric
separator 501A

Vertical separator for E-Chains®	
unassembled	501
assembled	511



Spacer*	
unassembled	405.XX
assembled	415.XX



Locking separator for E-Chains®	
unassembled	504
assembled	514



Locking separator for E-Chains®	
unassembled	508
assembled	518



Asymmetric separator for E-Chains®	
unassembled	501A
assembled	511A



*For side-mounted applications

Option 1: Vertical separators and spacers

● **Standard separator 501 for E-Chains®** offers safe stability due to its broad foot design, also when used with thick cables or hoses.

● Separators (e.g. "side mounted") for E-Chains® can be fixed in their position with **spacers 405.XX**. The available inner height will be reduced by 2 mm, per spacer and side. To avoid this, the parts can be assembled on outside of the crossbar (not for long travels) **XX = width of the spacer** (available 10, 15, 20, 30 and 40 mm)

Additionally:

● **Locking separator for E-Chains® 504-** with increased retention force for applications exposed to very high humidity or extreme loads. If locking separators are used, the E-Chain® is more difficult to open

● The **locking separator for E-Chains® 508** is designed for applications exposed to extremely high humidity, for example, at composting plants. The lateral cam serves for uniform alignment of the vertical separators; if these separators are misaligned, they will inevitably get damaged on an attempt to open the E-Chain®.

● **Asymmetric separator 501A for E-Chains®** (not for E-Tubes) with an 18-mm base, for combinations between spacers of different widths and vertical separators in side-mounted applications, for instance.

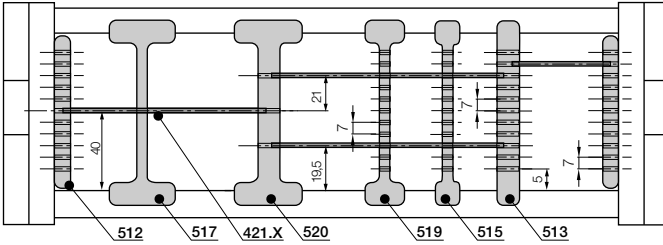

For use with many cables of differing diameters. E-Chains* and E-Tubes can be subdivided both vertically and horizontally. The shelves can be arranged elevator-shifted with different bottoms

Option 2: Shelves

● **Side plates 502, middle plates 503 and shelves 420.X** form the basic pattern of a shelf system. Shelves of various widths can be arranged at 11 different heights (in 7 mm increments).

● **Locking vertical separator 510** combined with shelves. Triple slots (only for E-Chains*).

● **Locking separator 507 slotted** - with increased retention force for applications exposed to very high humidity or extreme loads. The extra retention force is achieved by asymmetric claws for the crossbar. Ensure proper alignment.

● **Slotted separators 505** are used for very fine subdivisions. However, they cannot be retrofitted into an existing separation system without dismantling the interior separators first.

● The unilateral **open slotted separator 509** can be retrofitted into an existing interior separation system without a need for dismantling the interior separators. During an installation of open slotted separators, the top and bottom notches cannot be occupied by shelves.

Side plate for E-Chains*/E-Tubes	
unassembled	502
assembled	512

Middle plate for E-Chains*/E-Tubes	
unassembled	503
assembled	513

Locking vertical separator for E-Chains*	
unassembled	510
assembled	520

Locking separator for E-Chains*	
unassembled	507
assembled	517

Slotted separator for E-Chains*/E-Tubes	
unassembled	505
assembled	515

Open slotted separator for E-Chains*/E-Tubes	
unassembled	509
assembled	519

Width X [mm]	Part No. unassembled	Part No. assembled
018	420.18	421.18
023	420.23	421.23
025	420.25	421.25
028	420.28	421.28
033	420.33	421.33
043	420.43	421.43
050	420.50	421.50
062	420.62	421.62

Width X [mm]	Part No. unassembled	Part No. assembled
075	420.75	421.75
088	420.88	421.88
100	420.100	421.100
125	420.125	421.125
150	420.150	421.150
175	420.175	421.175
187	420.187	421.187
200	420.200	421.200



Side plate 502



Middle plate 503



Locking vertical separator 510



Locking separator slotted 507

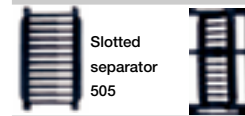

Slotted separator 505



Open slotted separator 509



Shelf 420.X

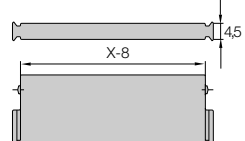

Additional elements for interior separation

Rollclip	
unassembled	489.27
assembled	490.27

Rollclip - minimizes abrasion of particularly sensitive hoses. The Rollclip is simply clamped onto the opening crossbar. The movable rollers compensate for relative movement between the chain and hose.



System E4/4
Inner height: 80 mm

Phone +49- (0) 22 03-96 49-800
Fax +49- (0) 22 03-96 49-222



▶ page 7.223

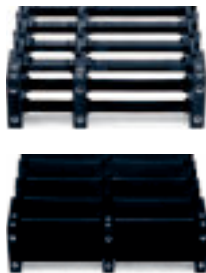

Extension links - for extremely wide E-Chains® up to 3,0 m

- For applications in which particularly high fill weights necessitate extremely wide E-Chains® (up to 3000 mm)
- The extension link design allows virtually limitless side-by-side attachment of chains
- The unsupported length of a chain can be increased when additional loads are required
- Extension links can be used with E-Chains®, E-Tubes or as a combination of both
- They are suitable for unsupported and gliding applications in a guide trough
- E-Chains® with extension links are attached with KMA or steel mounting brackets

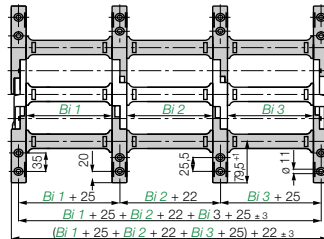
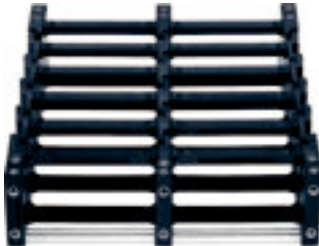

Part No. structure
5050.10 /20 /10. 200.0
5050.Bi1/Bi2/Bi3. R.0



Extender crossbars - careful guide of hoses applications

- Suitable for hoses with a maximum outer diameter of 270 mm
- Gliding operation with crossbars assembled along the outer radius and a special guide trough
- Gliding operation not guaranteed with crossbars assembled along the inner radius
- The extender crossbar can either be attached to the side links directly or can be used in combination with two stranded snap-open crossbars

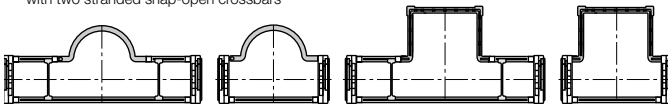

Round extender crossbar with snap-open crossbars Attached directly to the side link Square extender crossbar with snap-open crossbars Attached directly to the side link

Consult igus® for your extender crossbar applications. We are happy to assist you with your design layout

Part No.	Max Ø [mm] hose	Form	Installation side link	Combination with snap-open crossb.
450.15.RHD115	115	○	-	+
450.17.RD115	115	○	+	-
450.25.D150	150	□	+	-
450.30.D200	200	□	+	-
450.35.D250	220	□	+	-
450.40.D300	270	□	+	-
450.20.HD150	150	□	-	+
450.25.HD200	200	□	-	+
450.30.HD250	220	□	-	+

○ = round □ = square + = yes / - = no



E4 clip-on cable binder

- For side-mounted applications ● Serves as a clip-on, lateral guide for hoses and cables on E-Chains®
- The loops can be adjusted as required ● Compatible with many E4 E-Chains® ● Stylish and economical
- One clip and one locking band are needed for each chain link ● Call us if you have any questions on project planning

Part No.	Form
450.B12	Locking clip, comprising a locking element
450.B12.200	Locking band, comprising a locking element and band; 12 x 1,5 x 200 mm

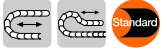

The Standard - Option KMA* - pivoting

- Recommended for unsupported and gliding applications
- Confined installation conditions
- Option - integrated C-profile strain relief device with Chainfix clip or strain relief tiwrap plates
- Corrosion resistant
- Universal mountable with attachment capability on all sides

*KMA = Polymer Metal Mounting Bracket

Moving end
50500/98500...1

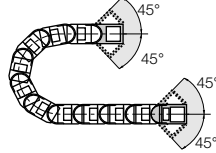

Fixed end
50500/98500...2



The attachment variants arising automatically by the choice of the KMA mounting bracket

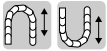
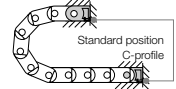

Option KMA - locking

- Recommended for vertical hanging / standing applications
- Additionally:**
- Universal mountable
 - C-profile option
 - Corrosion resistant
 - Locked connections
 - At very high acceleration

Moving end
51500/99500...1

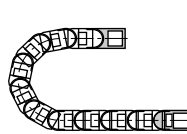

Fixed end
51500/99500...2



The attachment variants arising automatically by the choice of the KMA mounting bracket

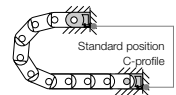

Fixed end
50500/98500...2 (pivoting)
51500/99500...2 (locking)

Moving end
(pivoting) 50500/98500...1
(locking) 51500/99500...1

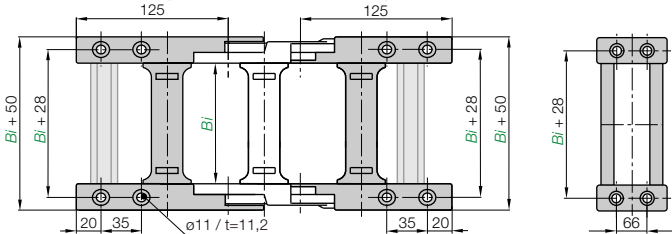

Dimensions and order configurations

Part No. structure (pivoting)

50500, 98500	07, 12, C	Optional with C-profile
		Full set
		Width 50500 = E-Chain 98500 = E-Tube

Part No. structure (locking)

51500, 99500	07, 12, C	Optional with C-profile
		Full set
		Width 51500 = E-Chain 99500 = E-Tube

Width index	Part No. full set			C-profile option [mm]	Bi	Width index	Part No. full set			C-profile option [mm]	Bi
	pivoting	locking	locking				pivoting	locking	locking		
.05.	50500	51500	51500	.05.12	50	.31.	50500	51500	.31.12	312	
.06.	50500	51500	51500	.06.12	65	.32.	50500	51500	.32.12	325	
.07.	50500/98500	51500/99500	51500/99500	.07.12	75	.33.	50500	51500	.33.12	337	
.08.	50500	51500	51500	.08.12	87	.35.	50500/98500	51500/99500	.35.12	350	
.10.	50500/98500	51500/99500	51500/99500	.10.12	100	.36.	50500	51500	.36.12	362	
.11.	50500	51500	51500	.11.12	112	.37.	50500	51500	.37.12	375	
.12.	50500/98500	51500/99500	51500/99500	.12.12	125	.38.	50500	51500	.38.12	387	
.13.	50500	51500	51500	.13.12	137	.40.	50500/98500	51500/99500	.40.12	400	
.15.	50500/98500	51500/99500	51500/99500	.15.12	150	.41.	50500	51500	.41.12	412	
.16.	50500	51500	51500	.16.12	162	.42.	50500	51500	.42.12	425	
.17.	50500	51500	51500	.17.12	175	.43.	50500	51500	.43.12	437	
.18.	50500	51500	51500	.18.12	187	.45.	50500	51500	.45.12	450	
.20.	50500/98500	51500/99500	51500/99500	.20.12	200	.46.	50500/98500	51500/99500	.46.12	462	
.21.	50500	51500	51500	.21.12	212	.47.	50500	51500	.47.12	475	
.22.	50500	51500	51500	.22.12	225	.48.	50500	51500	.48.12	487	
.23.	50500	51500	51500	.23.12	237	.50.	50500	51500	.50.12	500	
.25.	50500/98500	51500/99500	51500/99500	.25.12	250	.51.	50500	51500	.51.12	512	
.26.	50500	51500	51500	.26.12	262	.52.	50500	51500	.52.12	525	
.27.	50500	51500	51500	.27.12	275	.53.	50500	51500	.53.12	537	
.28.	50500	51500	51500	.28.12	287	.55.	50500	51500	.55.12	550	
.30.	50500/98500	51500/99500	51500/99500	.30.12	300	.60.	50500	51500	.60.12	600	

Full set, for both ends:

50500, 07, 12

Single-part order:

50500, 07, 1

Mounting bracket moving end

50500, 07, 2

Mounting bracket fixed end

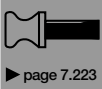
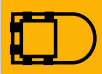

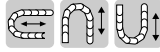

Option steel - pivoting

- For pivoting connections
- One part (two-piece) for all chain widths
- Electrically conductive

Moving end
50500.1

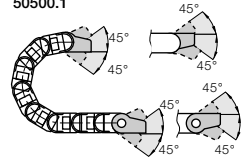

Fixed end
50500.2

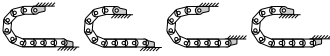

Possible installation conditions -

Further installation angles ► installation sketch

Moving end
50500.1

Fixed end
50500.2

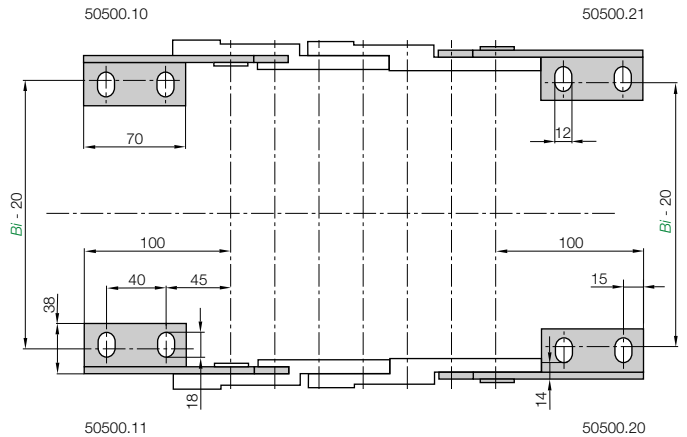

Phone +49- (0) 22 03-96 49-800
Fax +49- (0) 22 03-96 49-222

igus® GmbH
51147 Cologne

Internet: www.igus.eu
E-mail: info@igus.de

50500.12 Full set, 4 parts
2 with pin / 2 with bore

Single-part order:

- 50500.1** Mounting bracket moving end, 1 part left / right
- 50500.2** Mounting bracket fixed end, 1 part left / right

For E-Chain*	Part No. full set	Bi [mm]	For E-Chain*	Part No. full set	Bi [mm]
5050-5150.05	50500.12	50	5050-5150.31	50500.12	312
5050-5150.06	50500.12	65	5050-5150.32	50500.12	325
5050-5150-9850.07	50500.12	75	5050-5150.33	50500.12	337
5050-5150.08	50500.12	87	5050-5150-9850.35	50500.12	350
5050-5150-9850.10	50500.12	100	5050-5150.36	50500.12	362
5050-5150.11	50500.12	112	5050-5150.37	50500.12	375
5050-5150-9850.12	50500.12	125	5050-5150.38	50500.12	387
5050-5150.13	50500.12	137	5050-5150-9850.40	50500.12	400
5050-5150-9850.15	50500.12	150	5050-5150.41	50500.12	412
5050-5150.16	50500.12	162	5050-5150.42	50500.12	425
5050-5150.17	50500.12	175	5050-5150.43	50500.12	437
5050-5150.18	50500.12	187	5050-5150.45	50500.12	450
5050-5150-9850.20	50500.12	200	5050-5150-9850.46	50500.12	462
5050-5150.21	50500.12	212	5050-5150.47	50500.12	475
5050-5150.22	50500.12	225	5050-5150.48	50500.12	487
5050-5150.23	50500.12	237	5050-5150.50	50500.12	500
5050-5150-9850.25	50500.12	250	5050-5150.51	50500.12	512
5050-5150.26	50500.12	262	5050-5150.52	50500.12	525
5050-5150.27	50500.12	275	5050-5150.53	50500.12	537
5050-5150.28	50500.12	287	5050-5150.55	50500.12	550
5050-5150-9850.30	50500.12	300	5050-5150.60	50500.12	600

Chainfix clamps for the C-profile

Part No. single clamps		Part No. double clamps		Part No. triple clamps		Cable
steel	stainless steel	steel	stainless steel	steel	stainless steel	ø [mm]
CFX12.1	CFX12.1.E	CFX12.2	CFX12.2.E	CFX12.3	-	06 - 12
CFX14.1	CFX14.1.E	CFX14.2	CFX14.2.E	CFX14.3	-	12 - 14
CFX16.1	CFX16.1.E	CFX16.2	CFX16.2.E	CFX16.3	-	14 - 16
CFX18.1	CFX18.1.E	CFX18.2	CFX18.2.E	CFX18.3	-	16 - 18
CFX20.1	CFX20.1.E	CFX20.2	CFX20.2.E	CFX20.3	-	18 - 20
CFX22.1	CFX22.1.E	CFX22.2	CFX22.2.E	CFX22.3	-	20 - 22
CFX26.1	CFX26.1.E	CFX26.2	CFX26.2.E	-	-	22 - 26
CFX30.1	CFX30.1.E	CFX30.2	CFX30.2.E	-	-	26 - 30
CFX34.1	CFX34.1.E	CFX34.2	CFX34.2.E	-	-	30 - 34
CFX38.1	CFX38.1.E	-	-	-	-	34 - 38
CFX42.1	CFX42.1.E	-	-	-	-	38 - 42

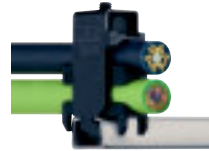

igus® Chainfix steel clamps and Chainfix stainless-steel clamps - max. pull forces, adjustable with hexagon socket. Available as single, double or triple clamps. **Details ▶ chapter 10**

System E4/4
Inner height: 80 mm

Cable ø [mm]	Part No. clamp	Part No. bottom part
04 - 08	CFC-08-M	CFC-08-C
08 - 12	CFC-12-M	CFC-12-C
12 - 16	CFC-16-M	CFC-16-C
16 - 20	CFC-20-M	CFC-20-C
20 - 24	CFC-24-M	CFC-24-C

Chainfix Clip - Modular snap-on strain relief device for C-profile

Available for all igus® E-ChainSystems® with C-profiles and also suitable for assembly in the KMA mounting brackets and clip-on strain relief for crossbars. High pull forces, plug-in modular snap-on strain relief device. **Details ▶ chapter 10**



Part No.	ø max. conduit [mm]	Width [mm]
CFN.20	20	10,8
CFN.30.52	30	16,8
CFN.20.N35	20	20,0

Chainfix Nugget for the C-Profile

Strain relief for the fixation of cables up to a diameter of Ø 30 mm. Easy to assemble, without any screws and tools. Easy strain relief due to fixation with pre-hressed cable strap, very small space requirement. **Details ▶ chapter 10**



Part No.	Width of strain relief [mm]	Number of teeth
3050.ZC	50	5
3075.ZC	75	7

Chainfix tiwrap plates with clip-on connection for the C-profile

Can be plugged into the KMA C-profile. Easy to assemble without any screws. Easily solvable with screwdriver nevertheless safe stop. For all E-Chains® with KMA and integrated C-profile. **Details ▶ chapter 10**

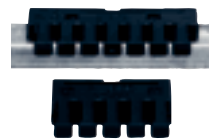

Tiewrap plate	No. of teeth n	Dim. C [mm]	Dim. B [mm]	Center bore
3050.ZB	5	50	30	-
3075.ZB	7	75	55	-
3100.ZB	10	100	80	-
3115.ZB	11	115	95	-
3125.ZB	12	125	105	-
3150.ZB	15	150	130	-
3175.ZB	17	175	155	-
3200.ZB	20	200	180	+
3225.ZB	22	225	205	+
3250.ZB	25	250	230	+

(- = no / + = yes)

Tiewrap plate as individual part

As individual component screwed on KMA. Can be plugged in the mounting brackets. **Details ▶ chapter 10**

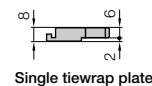
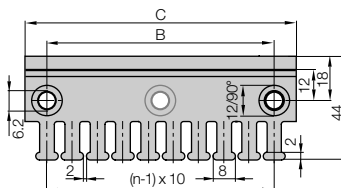

Single tiewrap plate

Shown assembled



▶ page 7.223

- B_a = Outer width E-Chains* / E-Tube
- B_i = Inner width E-Chains* / E-Tube
- h_a = Outer height E-Chains* / E-Tube
- H_{Ri} = Inner trough height
- H_{Ra} = Outer trough height
- B_{Ri} = Inner trough width ▶ depends on dim. B_a
- B_{Ra} = Outer trough width
- n_{Mon} = Number of installation sets (left/right)
- n_{Ri} = Number of troughs sets (left/right)
- $H_{Ri} \geq 2 \cdot h_a$
- $B_{Ri} \geq B_a + 4$
- = Guide trough set ● = Glide bar
- = Installation set "Basic" ● = C-profile

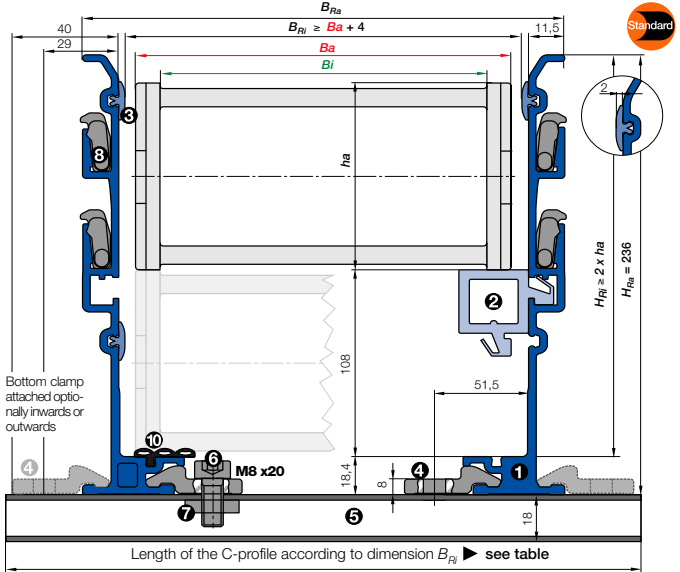

Installation set "Basic" with C-profile

Bottom Clamp attached optionally inwards or outwards

5050.30.300.0 ▶ Order example

B_{Ri} [mm]	Part No. attached	
	inwards	outwards
.06	104	-
.06	119	-
.07	129	-
.08	141	960.50.200
.10	154	960.50.225
.11	167	960.50.225
.12	179	960.50.250
.13	192	960.50.250
.15	204	960.50.275
.16	217	960.50.275
.17	229	960.50.300
.18	242	960.50.300
.20	254	960.50.325
.21	267	960.50.325
.22	279	960.50.350
.23	292	960.50.350
.25	304	960.50.375
.26	317	960.50.375
.27	329	960.50.400
.28	342	960.50.400
.30	354	960.50.425
.31	367	960.50.425
.32	379	960.50.450
.33	392	960.50.450
.35	404	960.50.475
.36	417	960.50.475
.37	429	960.50.500
.38	442	960.50.500
.40	454	960.50.525
.41	467	960.50.525
.42	479	960.50.550
.43	492	960.50.550
.45	504	960.50.575
.46	517	960.50.575
.47	529	960.50.600
.48	542	960.50.600
.50	554	960.50.625
.51	567	960.50.625
.52	579	960.50.650
.53	592	960.50.650
.55	604	960.50.725
.60	654	960.50.725



- **Components, trough "Basic":** ① Trough side parts, aluminum, 2 m ② Glide bar, plastic, 2 m ③ Glide strips, plastic, 2 m (without glide strips on request) ⑩ Optional: Silencer profile, rubber
- **Components, installation set "Basic":** ④ Bottom clamp, aluminum ⑤ C-profile, steel galvanized ⑥ Screw M8 x20 ⑦ Sliding nut M8 ⑧ Interface connector, plastic



Order example: Length of travel 30 m - Center mounted for Series 5050.30.300.0 with $B_{Ri} = 345$

- Guide trough set (set of 2 trough side parts, incl. glide strips) **without** glide bar
Order text: 16 m guide trough without glide bar (8 x 2 m sections) **Part No. 975.30.SL**
- Guide trough set (set of 2 trough side parts, incl. glide strips) **with** glide bar
Order text: 16 m guide trough with glide bar (8 x 2 m sections) **Part No. 975.31.SL**
- Installation set "Basic" complete (guide-sets + 1)
Order text: 17 installation sets "Basic" **Part No. 960.50.425**
- Module for the fixed end
Order text: 1 set **Part No. 975.80**
- Option:** For an additional noise dampening with silencer profile, please add Index A - Example: **Part No. 975.30.SLA**

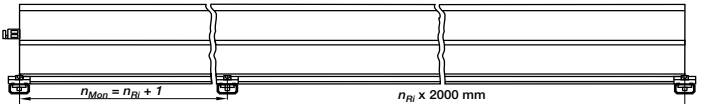

Principle sketch: Number of installation sets to be installed = Number of trough sections + 1



A quick fix for mounting the stationary end of an E-Chain*
With this module for the fixed end, fast and easy mounting onto the Aluminum "SuperTrough" is now possible without any drilling. Fast mounting of the E-Chain* by clamping onto the aluminum trough
● Quick relocation of the stationary end ● No drilling necessary ▶ page 9.16

Phone +49- (0) 22 03-96 49-800
Fax +49- (0) 22 03-96 49-222

igus* GmbH
51147 Cologne

Internet: www.igus.eu
E-mail: info@igus.de

Insert for the installation set "Heavy-Duty": **975.50.XXX** instead of (960.50.XXX) on the right column "attached outwards"



Very robust E4/4 E-Chain®
serie 5050 with middle
strap in a steel factory. Heat
and dust are no problem
for the maintenance-free
igus® polymer E-Chain®
since almost 3 years

System E4/4
Inner height: 80 mm

Phone +49- (0) 22 03-96 49-800
Fax +49- (0) 22 03-96 49-222



▶ Chapter 9



▶ page 7.223



5050AX and 5050HDAX

Special E-Chains® for fine dust applications

Long travel of 300 m and more are for instance often found in coal conveyors. For these travel lengths, types of loads and dirt accumulations, we have developed a special E-ChainSystem® with exterior, dirt-repellent stop dogs.

- Exterior stop dogs prevent the settling of dust, dirt, chips, flour, etc.
- Mounting brackets and accessories from the E4/4 series
- Also available as heavy-duty-version - Series 5050HDAX

Series 5050AX - Order example 5050AX.30.250.0 / Series 5050HDAX - Order example 5050HDAX.30.250.0
Further information: igus.de/en/5050AX or phone +49-0 22 03-96 49-800

Price index



Series 5050HD Series R9850HD



"Heavy-Duty" version
for long travel applications



ESD classification:
Electrically conductive ESD/ATEX
version upon request



Very high
torsional rigidity



Opening E-Chains: Remove crossbars and clips - Insert screwdriver into the slot, push down, release by lever action



Remove lids/bottoms (E-Tubes) - Insert screwdriver into the slot, release by lever action



When to use the Series 5050HD/R9850HD:

- For high (tensile-)charges at long travel applications
- When high torsional forces are expected
- For long-term operation in very moist environments
- Also available as Rol E-Chain®



When not to use them:

- At short travels or medium additional loads
▶ Series E4.80, page 7.76
- If a simple and low-cost solution is required
▶ Series 15050/15150/R19850, page 7.144

- 1 High side-mount stability due to undercut
- 2 High torsional rigidity
- 3 High tensile stability (20% higher tensile force than Series 5050)
- 4 Very wide gliding surface, less wear
- 5 Closed and open styles can be combined
- 6 Hinged snap-open removable lids along outer radius of E-Tube
- 7 Numerous interior separation possibilities
- 8 Crossbars are removable along both radii
- 9 Wide, rounded plastic crossbars - cable friendly
- 10 Robust Steel-Mounting Brackets



Rol E-Chain® Series
5050RHD/9850RHD
available upon request



Order example complete E-Chain®

Please indicate chain-lengths or number of links Example: 5 m or 55 links

5 m 5050HD.30.300.0



E-Chain®

with 2 separators 511 assembled every 2nd link

Interior separation

1 set 5050HD.12.E



Mounting bracket



Unsupported length

FL_G = with straight upper run

FL_B = with permitted sag

Further information ► **Design, page 1.12**

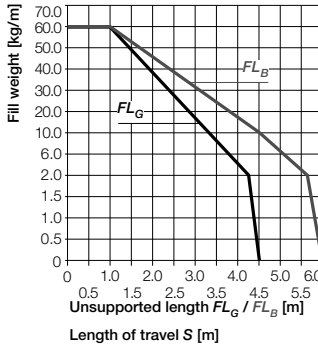
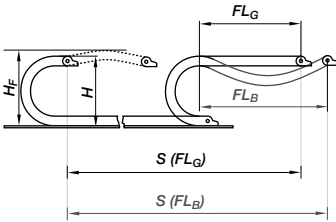

- S = Length of travel
- R = Bending radius
- H = Nominal clearance height
- H_F = Required clearance height
- H_{R1} = Trough inner height
- D = Overlength E-Chain" radius in final position
- $K = \pi \cdot R + \text{"safety"}$
- D_2 = Over length - long travels, gliding
- K_2 = "Further add-on
- H_2 = "Mounting height

*if the mounting bracket location is set lower

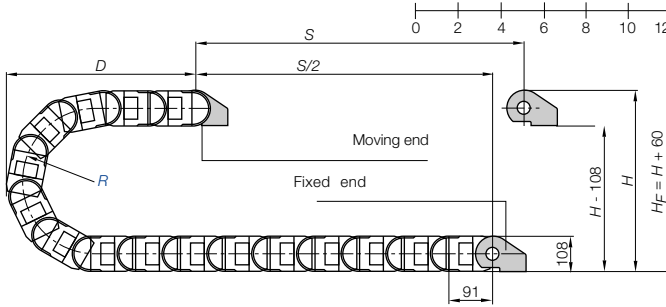

Pitch = 91 mm/Glided Links/m = 11 (1001 mm) Chain length = $S/2 + K$

R	200	300	350	500
H	508	708	808	1108
D	345	445	495	645
K	815	1125	1285	1755
H_2	242	242	242	242
D_2	800	1200	1550	2175
K_2	1274	2002	2457	3458



Short travels - unsupported

Unsupported E-Chains" feature positive camber over short travels. This must be accounted for when specifying the clearance height H_F . Please consult igus" if space is particularly restricted.

The required clearance height:

$H_F = H + 60 \text{ mm}$
(with 3,0 kg/m fill weight)

Long travel lengths from 10 m to max. 500 m Chain length = $S/2 + K_2$

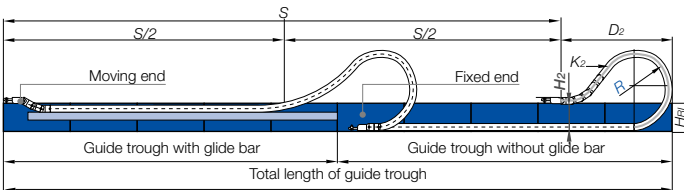

In case of travels between 4 and 10 m we recommend a longer unsupported length.



Gliding, long travel applications (max. 500 m)

In this case the E-Chain" upper run will be introduced in a guide trough on the lower run. We recommend to realize the engineering of such a plant by our technicians.

Technical Data

Speed / acceleration FL_G	max. 20 [m/s] / max. 200 [m/s ²]
Speed / acceleration FL_B	max. 3 [m/s] / max. 6 [m/s ²]
Gliding speed / acceleration (maximum)	max. 10 [m/s] / max. 50 [m/s ²]
Material - permitted temperature °C	igumid G / -40° up to +120° C
Flammability class, igumid G	VDE 0304 IIC UL94 HB



Details of material properties

► page 1.38

80

System E4/4
Inner height: 80 mm

Phone +49- (0) 22 03-96 49-800
Fax +49- (0) 22 03-96 49-222



► page 7.223

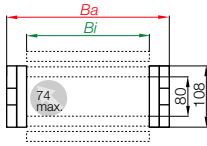

Part No. structure

5050HD. 30. 300. 0



Serie 5050HD - E-Chain® with crossbars every link

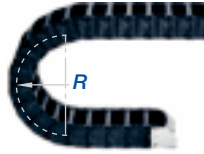

- Crossbars every link
- For highest additional loads
- For applications particularly demanding
- Can be opened from two sides



Phone+49- (0) 22 03-96 49-800
Fax +49- (0) 22 03-96 49-222

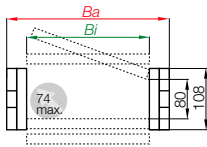

Part No. structure

9850HD. 30. 300. 0



Serie R9850HD - Fully enclosed E-Tube

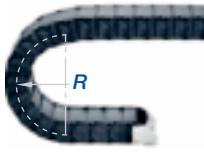

- Fully enclosed
- Excellent cable protection against dirt
- Protection against hot chips
- Lids along the entire inner radius are completely removable. Lids along the entire outer radius are single sided snap-open with a hinge on the other side to keep them attached to the chain or completely removable



igus® GmbH
51147 Cologne

Internet: www.igus.eu
E-mail: info@igus.de

Rol instead of gliding: Rol E-Chain®

Special solution for long travels. 75% less drive power (gliding application) with igus® Rol E-Chain®. Series 5050RHD and 9850RHD - Order example 5050RHD.30.300.0

Further information: www.igus.de/en/role
or phone: +49-0 22 03-96 49-800



Part No.		<i>Bi</i>	<i>Ba</i>	5050HD R9850HD	
		[mm]	[mm]	[kg/m]	[kg/m]
5050HD.05.....	<input type="checkbox"/>	50	110	≈ 6,65	-
5050HD.06.....	<input type="checkbox"/>	65	125	≈ 6,74	-
5050HD/9850HD.07.....	<input type="checkbox"/>	75	135	≈ 6,81	≈ 7,25
5050HD.08.....	<input type="checkbox"/>	87	147	≈ 6,89	-
5050HD/9850HD.10.....	<input type="checkbox"/>	100	160	≈ 6,99	≈ 7,55
5050HD.11.....	<input type="checkbox"/>	112	172	≈ 7,10	-
5050HD/9850HD.12.....	<input type="checkbox"/>	125	185	≈ 7,18	≈ 7,91
5050HD.13.....	<input type="checkbox"/>	137	197	≈ 7,32	-
5050HD/9850HD.15.....	<input type="checkbox"/>	150	210	≈ 7,35	≈ 8,29
5050HD.16.....	<input type="checkbox"/>	162	222	≈ 7,47	-
5050HD.17.....	<input type="checkbox"/>	175	235	≈ 7,60	-
5050HD.18.....	<input type="checkbox"/>	187	247	≈ 7,71	-
5050HD/9850HD.20.....	<input type="checkbox"/>	200	260	≈ 7,77	≈ 8,91
5050HD.21.....	<input type="checkbox"/>	212	272	≈ 7,84	-
5050HD.22.....	<input type="checkbox"/>	225	285	≈ 7,91	-
5050HD.23.....	<input type="checkbox"/>	237	297	≈ 8,02	-
5050HD/9850HD.25.....	<input type="checkbox"/>	250	310	≈ 8,13	≈ 9,64
5050HD.26.....	<input type="checkbox"/>	262	322	≈ 8,22	-
5050HD/9850HD.27.....	<input type="checkbox"/>	275	335	≈ 8,32	≈ 10,00
5050HD.28.....	<input type="checkbox"/>	287	347	≈ 8,38	-
5050HD/9850HD.30.....	<input type="checkbox"/>	300	360	≈ 8,53	≈ 10,30
5050HD.31.....	<input type="checkbox"/>	312	372	≈ 8,57	-
5050HD.32.....	<input type="checkbox"/>	325	385	≈ 8,67	-
5050HD.33.....	<input type="checkbox"/>	337	397	≈ 8,79	-
5050HD/9850HD.35.....	<input type="checkbox"/>	350	410	≈ 8,99	≈ 11,00
5050HD.36.....	<input type="checkbox"/>	362	422	≈ 8,90	-
5050HD.37.....	<input type="checkbox"/>	375	435	≈ 9,00	-
5050HD.38.....	<input type="checkbox"/>	387	447	≈ 9,11	-
5050HD/9850HD.40.....	<input type="checkbox"/>	400	460	≈ 9,38	≈ 12,00
5050HD.41.....	<input type="checkbox"/>	412	472	≈ 9,31	-
5050HD.42.....	<input type="checkbox"/>	425	485	≈ 9,60	-
5050HD.43.....	<input type="checkbox"/>	437	497	≈ 9,44	-
5050HD.45.....	<input type="checkbox"/>	450	510	≈ 9,55	-
5050HD/9850HD.46.....	<input type="checkbox"/>	462	522	≈ 9,72	≈ 12,47
5050HD.47.....	<input type="checkbox"/>	475	535	≈ 9,76	-
5050HD.48.....	<input type="checkbox"/>	487	547	≈ 10,01	-
5050HD.50.....	<input type="checkbox"/>	500	560	≈ 10,11	-
5050HD.51.....	<input type="checkbox"/>	512	572	≈ 10,02	-
5050HD.52.....	<input type="checkbox"/>	525	585	≈ 10,19	-
5050HD.53.....	<input type="checkbox"/>	537	597	≈ 10,29	-
5050HD.55.....	<input type="checkbox"/>	550	610	≈ 10,71	-
5050HD.60.....	<input type="checkbox"/>	600	660	≈ 10,94	-

Available bending radii

R [mm] 200 300 350 500

Supplement Part No. with required radius. Example: 5050HD.30.0

0 = standard color, other colors ▶ page 1.39 · Pitch = 91 mm/link - Links/m = 11

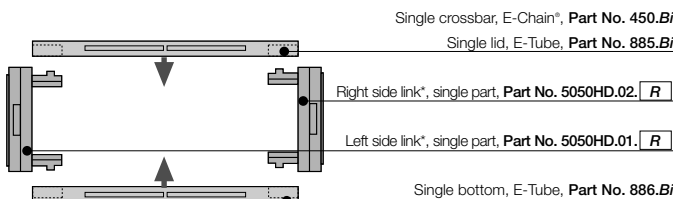

Extender crossbar for large diameter hoses ▶ page 7.274

Part No. E-Chain® - links, single parts

*View from the fixed point of the E-Chain®/E-Tube



System E4/4
Inner height: 80 mm

Phone +49- (0) 22 03-96 49-800
Fax +49- (0) 22 03-96 49-222

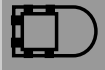

▶ page 7.223



Vertical separators are used if a vertical subdivision is required. In the standard configuration, a separator is mounted at every second link. **Note:** Observe a lateral spacing of at least 33 mm (E-Tube) and 16 mm (E-Chain)!

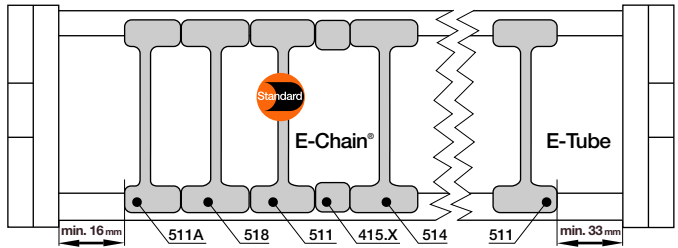

Vertical separator
501



Spacer
405.XX



Locking separator
504



Locking separator
508



Asymmetric
separator 501A

Vertical separator

for E-Chains®

unassembled	501
assembled	511



Spacer*

for E-Chains®

unassembled	405.XX
assembled	415.XX



Locking separator

for E-Chains®

unassembled	504
assembled	514



Locking separator

for E-Chains®

unassembled	508
assembled	518



Asymmetric separator

for E-Chains®

unassembled	501A
assembled	511A



*For side-mounted applications

Option 1: Vertical separators and spacers

● **Standard separator 501 for E-Chains®** offers safe stability due to its broad foot design, also when used with thick cables or hoses.

● Separators (e.g. "side mounted") for E-Chains® can be fixed in their position with **spacers 405.XX**. The available inner height will be reduced by 2 mm, per spacer and side. To avoid this, the parts can be assembled on outside of the crossbar (not for long travels) **XX = width of the spacer** (available 10, 15, 20, 30 and 40 mm)

Additionally:

● **Locking separator for E-Chains® 504-** with increased retention force for applications exposed to very high humidity or extreme loads. If locking separators are used, the E-Chain® is more difficult to open

● The **locking separator for E-Chains® 508** is designed for applications exposed to extremely high humidity, for example, at composting plants. The lateral cam serves for uniform alignment of the vertical separators; if these separators are misaligned, they will inevitably get damaged on an attempt to open the E-Chain®.

● **Asymmetric separator 501A for E-Chains®** (not for E-Tubes) with an 18-mm base, for combinations between spacers of different widths and vertical separators in side-mounted applications, for instance.

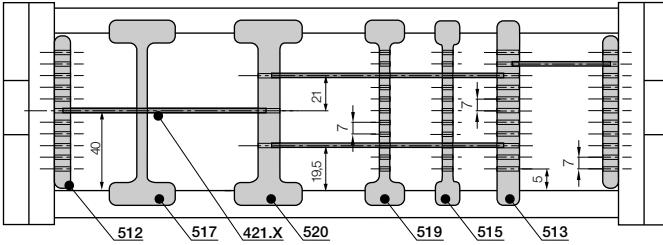

For use with many cables of differing diameters. E-Chains* and E-Tubes can be subdivided both vertically and horizontally. The shelves can be arranged elevator-shifted with different bottoms

Option 2: Shelves

● **Side plates 502, middle plates 503 and shelves 420.X** form the basic pattern of a shelf system. Shelves of various widths can be arranged at 11 different heights (in 7 mm increments).

● **Locking vertical separator 510** combined with shelves. Triple slots (only for E-Chains*).

● **Locking separator 507 slotted** - with increased retention force for applications exposed to very high humidity or extreme loads. The extra retention force is achieved by asymmetric claws for the crossbar. Ensure proper alignment.

● **Slotted separators 505** are used for very fine subdivisions. However, they cannot be retrofitted into an existing separation system without dismantling the interior separators first.

● The unilateral **open slotted separator 509** can be retrofitted into an existing interior separation system without a need for dismantling the interior separators. During an installation of open slotted separators, the top and bottom notches cannot be occupied by shelves.

Side plate for E-Chains*/E-Tubes	
unassembled	502
assembled	512

Middle plate for E-Chains*/E-Tubes	
unassembled	503
assembled	513

Locking vertical separator for E-Chains*	
unassembled	510
assembled	520

Locking separator for E-Chains*	
unassembled	507
assembled	517

Slotted separator for E-Chains*/E-Tubes	
unassembled	505
assembled	515

Open slotted separator for E-Chains*/E-Tubes	
unassembled	509
assembled	519

Width X [mm]	Part No. unassembled	Part No. assembled
018	420.18	421.18
023	420.23	421.23
025	420.25	421.25
028	420.28	421.28
033	420.33	421.33
043	420.43	421.43
050	420.50	421.50
062	420.62	421.62

Width X [mm]	Part No. unassembled	Part No. assembled
075	420.75	421.75
088	420.88	421.88
100	420.100	421.100
125	420.125	421.125
150	420.150	421.150
175	420.175	421.175
187	420.187	421.187
200	420.200	421.200

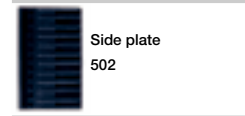

Side plate 502



Middle plate 503



Locking vertical separator 510



Locking separator slotted 507

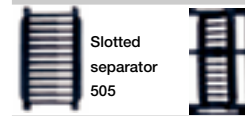

Slotted separator 505



Open slotted separator 509



Shelf 420.X

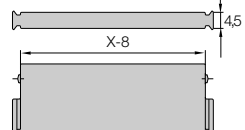

Additional elements for interior separation

Rollclip	
unassembled	489.27
assembled	490.27

Rollclip - minimizes abrasion of particularly sensitive hoses. The Rollclip is simply clamped onto the opening crossbar. The movable rollers compensate for relative movement between the chain and hose.



System E4/4
Inner height: 80 mm

Phone +49- (0) 22 03-96 49-800
Fax +49- (0) 22 03-96 49-222

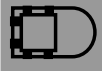

▶ page 7.223

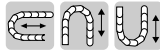

Option steel - pivoting

- For pivoting connections
- One part (two-piece) for all chain widths
- Electrically conductive

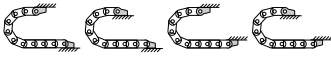

Possible installation conditions -

Further installation angles ► installation sketch

Moving end
50500HD.1.E

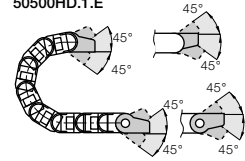

Fixed end
50500HD.2.E

Moving end
50500HD.1.E

Fixed end
50500HD.2.E

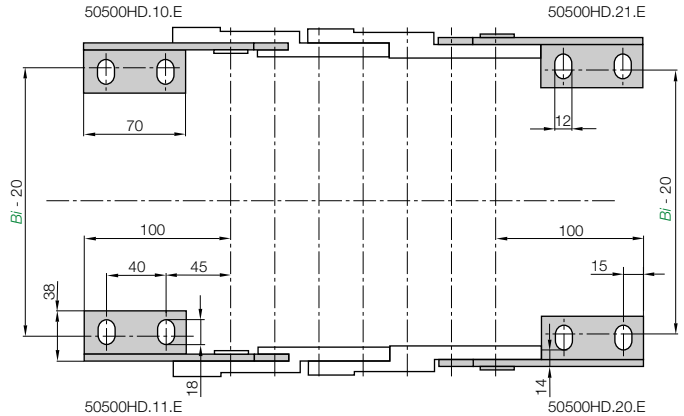

Part No.	Mounting bracket
50500HD.12.E	Full set, 4 parts, 2 with pin / 2 with bore
50500HD.1.E	Mounting bracket moving end, 1 part left / right
50500HD.2.E	Mounting bracket fixed end, 1 part left / right

Phone +49- (0) 22 03-96 49-800
Fax +49- (0) 22 03-96 49-222

igus® GmbH
51147 Cologne

E4/4 | Series 5050HD-R9850HD | Accessories | Strain Relief

Tiewrap plate as individual part

As individual component screwed on KMA. Can be plugged in the mounting brackets. **Details ► chapter 10**

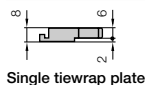

Single tiewrap plate

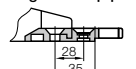

Shown assembled

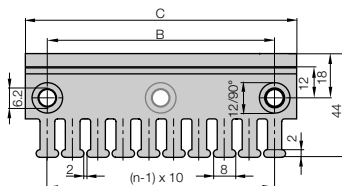

Tiewrap plate	No. of teeth n	Dim. C [mm]	Dim. B [mm]	Center bore
3050.ZB	5	50	30	-
3075.ZB	7	75	55	-
3100.ZB	10	100	80	-
3115.ZB	11	115	95	-
3125.ZB	12	125	105	-
3150.ZB	15	150	130	-
3175.ZB	17	175	155	-
3200.ZB	20	200	180	+
3225.ZB	22	225	205	+
3250.ZB	25	250	230	+

(- = no / + = yes)

Internet: www.igus.eu
E-mail: info@igus.de

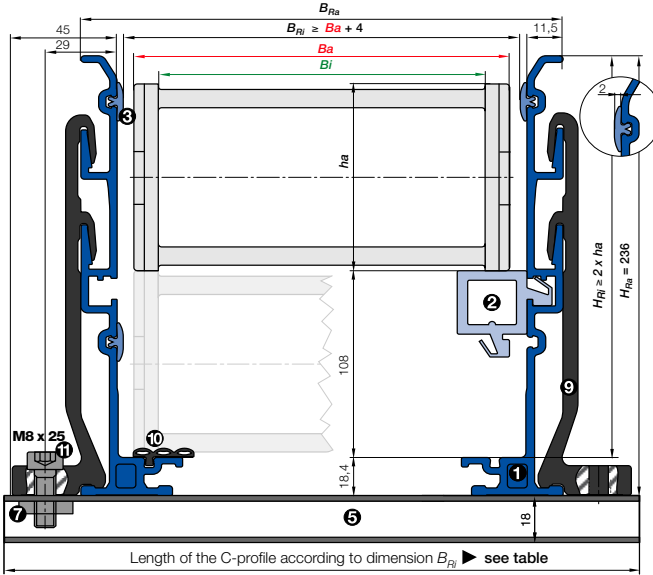

- B_a = Outer width E-Chains* / E-Tube
- B_i = Inner width E-Chains* / E-Tube
- h_a = Outer height E-Chains* / E-Tube
- H_{Ri} = Inner trough height
- H_{Ra} = Outer trough height
- B_{Ri} = Inner trough width ▶ depends on dim. B_a
- B_{Ra} = Outer trough width
- n_{Mon} = Number of installation sets (left/right)
- n_{Ri} = Number of trough sets (left/right)
- $H_{Ri} \geq 2 \cdot h_a$
- $B_{Ri} \geq B_a + 4$
- = Guide trough set ● = Installation set "Basic"
- = Glide bar ● = C-profile

Installation set Heavy-Duty with C-profile

5050HD.30.300.0 ▶ Order example

B_{Ri} [mm]	Part No. assembled
.05	114 974.50.250
.06	129 974.50.250
.07	139 974.50.275
.08	151 974.50.275
.10	164 974.50.300
.11	176 974.50.300
.12	189 974.50.325
.13	201 97450.325
.15	214 97450.350
.16	226 974.50.350
.17	239 97450.375
.18	251 974.50.375
.20	264 974.50.400
.21	276 974.50.400
.22	289 974.50.425
.23	301 974.50.425
.25	314 974.50.450
.26	326 974.50.450
.27	339 974.50.475
.28	351 974.50.475
.30	364 974.50.500
.31	376 974.50.500
.32	389 974.50.525
.33	401 974.50.525
.35	414 974.50.550
.36	426 974.50.550
.37	439 974.50.575
.38	451 974.50.575
.40	464 974.50.600
.41	476 974.50.600
.42	489 974.50.625
.43	501 974.50.625
.45	514 974.50.650
.46	526 974.50.650
.47	539 974.50.675
.48	551 974.50.675
.50	564 974.50.700
.51	576 974.50.700
.52	589 974.50.725
.53	601 974.50.725
.55	614 974.50.750
.60	664 974.50.800



- **Components, trough "Heavy Duty":** ① Trough side parts, aluminum, 2 m ② Glide bar, plastic, 2 m ③ Glide strips, plastic, 2 m (without glide strips on request) ⑩ Optional: Silencer profile, rubber
- **Components, installation set "Heavy Duty":** ⑤ C-profile, steel galvanized ⑦ Sliding nut M6 ⑨ Installation angle bracket "Heavy Duty", Aluminium ⑪ Screw M8 x 25

Order example: Length of travel 30 m - Center mounted for Series 5050HD.30.300.0 with $B_{Ri} = 364$

- Guide trough set (set of 2 trough side parts, incl. glide strips) **without** glide bar
Order text: 16 m guide trough without glide bar (8 x 2 m sections) Part No. 975.30.SL
- Guide trough set (set of 2 trough side parts, incl. glide strips) **with** glide bar
Order text: 16 m guide trough with glide bar (8 x 2 m sections) Part No. 975.31.SL
- Installation set "Basic" complete (guide trough-sets + 1)
Order text: 17 installation sets "Basic" Part No. 960.50.500
- Option:** For an additional noise dampening with silencer profile, please add Index A - Example: **Part No. 975.30.SLA**

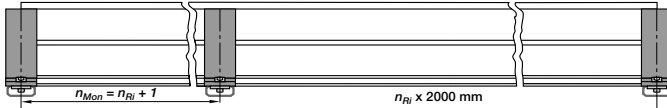

Principle sketch: Number of installation sets to be installed = **Number of trough sections + 1**

Phone +49- (0) 22 03-96 49-800
 Fax +49- (0) 22 03-96 49-222



▶ Chapter 10



▶ Chapter 9



▶ page 7.223

E3...T3...





...E6

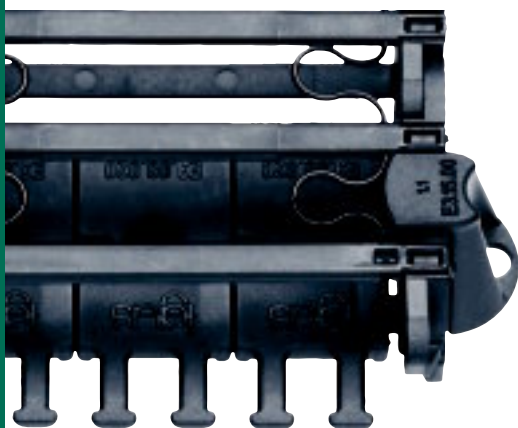

System E3 - Elastic, dampening connector strip replaces pins and bores

- Superquiet E-Chain® for small spaces with modular 3-piece link design
 - 3 Sizes available
 - Interior heights: 10 mm, 15 mm, 22 mm
- ▶ from page 8.4



System T3 - Highly flexible, low-vibration band chain without pin and bore connection

- For short strokes with extreme demands on low noise and dynamics
 - For high speed and high accelerations
 - Very low weight
 - Hardly any abrasion
 - Cost-efficient, 3-piece E-Chain®
- ▶ from page 8.22



System E6 - connector replaces pins and bores

- Superquiet E-Chain® with high stability and tensile strength and modular 6-piece link design
 - 5 Sizes available
 - 3 Types available (E-Chain®, E-Tube and Light-Version)
 - Interior heights: 29 mm, 40 mm, 52 mm, 62 mm, 80 mm
- ▶ from page 8.34



The extremely low-noise igus® E-Chain® - E3, T3 and E6 Systems

The E-Chain® of the E3, T3 and E6 Series have extremely good low noise and vibration performance. The special, abrasion-resistant spring elements replace the conventional pin and bore connection of the chain links enabling the low noise and vibration operation of the E-Chain®. Due to the special fastening system, the E-ChainSystems® have low wear or abrasion and are

therefore suitable for cleanroom applications. Another advantage of the connector is that in the application of an electrically conductive material (igumid ESD on request) it can guarantee a constant conductance value. The E-Chain® Series E3, T3 and E6 offer an extensive accessories package and are available in many dimensions off the shelf.

Measurement values of sound pressure levels dB(A) in comparison

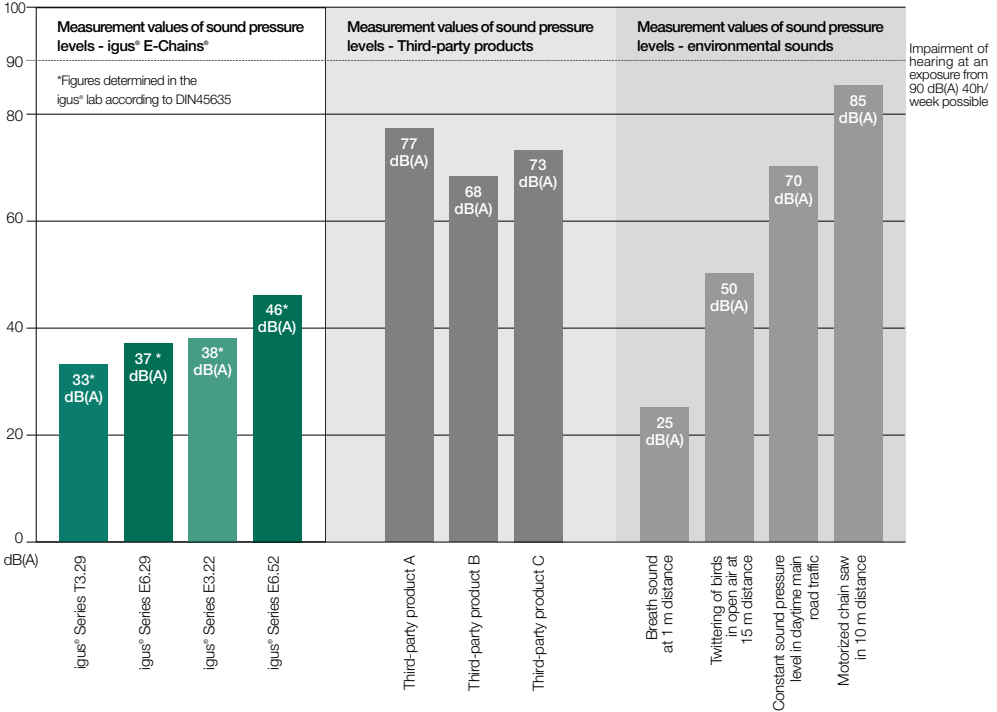

igus® goes clean room - qualification of E3 and E6 E-Chains®

IPA Fraunhofer Institute has tested igus® Series E3, E4, E6 and Easy Chain® as follows:

- ISO class 1, as per stringent norm DIN EN ISO 14644-1 for System E3, Series E3.15.040.075.0 at v = 0,5 m/s, 1 m/s, 2 m/s
- ISO class 1, as per stringent norm DIN EN ISO 14644-1 for System E6 - special material®, Series E6.29.060.150.0.CR at v = 0,5 m/s, 2 m/s
- ISO class 3, as per stringent norm DIN EN ISO 14644-1 for System E6 - standard material, Series E6.29.060.150.0 at v = 0,5 m/s, 1 m/s, 2 m/s
- ISO class 3, as per stringent norm DIN EN ISO 14644-1 for System E6, Series E6.29.050 at v = 1 and 2 m/s

Class per DIN EN ISO 14644-1	Equivalent to VDI 2083	Equivalent to US Fed.Std. 209E	Classification Series	Speed [m/s]
ISO class 1	no comparable classification	no comparable classification	E3.15.040.075.0	0,5 / 1,0 / 2,0
ISO class 1	no comparable classification	no comparable classification	E6.29.060.150.0.CR*	0,5 / 2,0
ISO class 3	class 1	class 1	E6.29.060.150.0	0,5 / 1,0 / 2,0
ISO class 4	class 2	class 10		
ISO class 5	class 3	class 100		
ISO class 6	class 4	class 1.000		
ISO class 7	class 5	class 10.000		
ISO class 8	class 6	class 100.000		

special material "clean room"



Fraunhofer Institut
Production
technology
and automation



E3.00.020

E3.00.020

snbi

snbi



E3

E3 - Highly dynamic and cleanroom compatible

The igus® System E3 combines small pitches, smooth running, low noise, stability, easy assembly and economic efficiency all in one. The spring connector element replaces the pin and bore principle and avoids relative movements between the joints. This means virtually no wear or abrasion for Cleanroom applications. To reduce production and assembling costs, the spring connector is not mounted individually, but on a length of ten chain links. Another E3 option is safe performance. A modified spring element made of electrically conductive material, which connects the chain links mechanically and electrically, permanently guarantees constant electrical conductance, even at high bending stress and in any position.

Typical industries and applications

- Semi-conductor manufacturing and handling
- Pick and place robots
- Optics
- Materials handling technology
- Measuring technology
- Printers and plotters
- Cleanroom environments
- General mechanical engineering



IPA Qualification Certificate - Report IG0704-400:
ISO Class 1, according to Norm DIN EN ISO 14644-1 for System
E3, Series E3.15.040.075.0 at $v = 0,5$ m/s, 1 m/s, 2 m/s



38 dB(A) - Value determined at the igus® test-lab acc. to DIN 45635, with consideration of background noises, for Series E3.22.060.044.0 at $v = 1,8$ m/s



iF-Design
Award 2005



Special equipment: Electrically conductive
ESD/ATEX version upon request

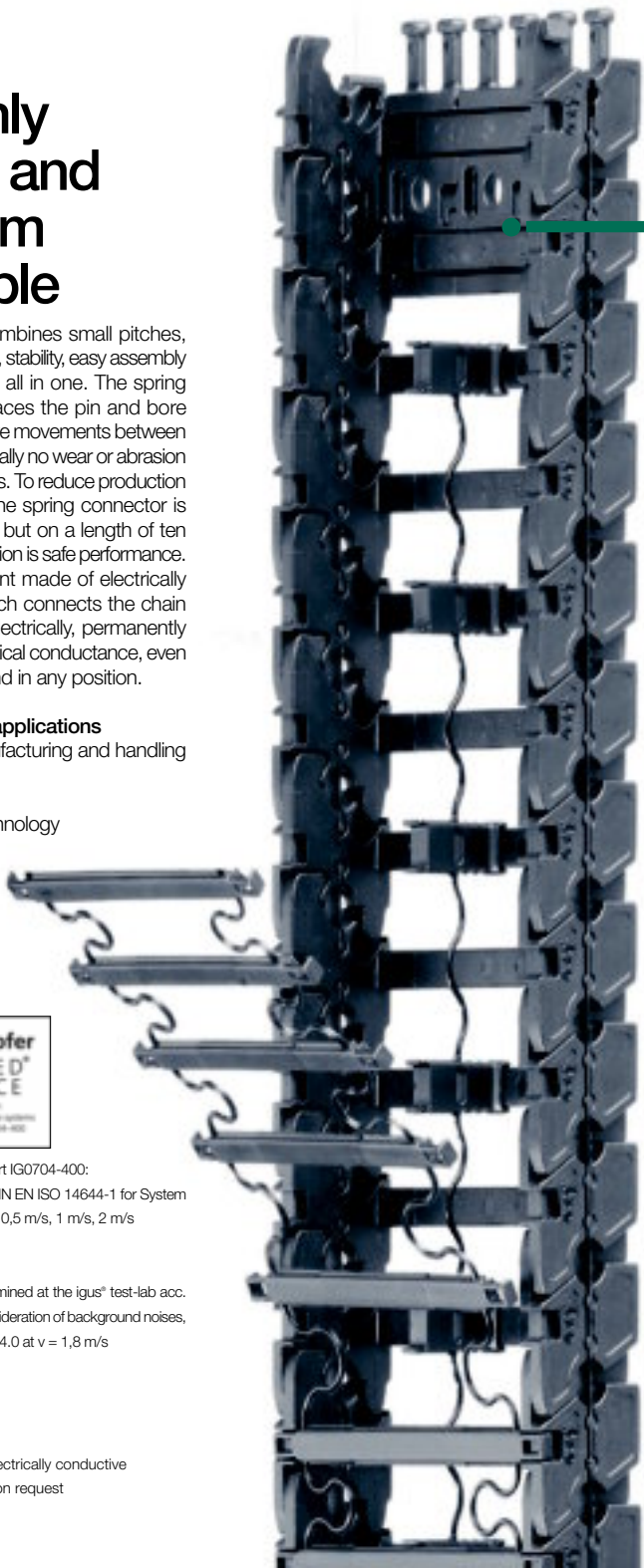



Long-term tests in our acoustics laboratory at a speed of 1.8 m/s and an acceleration of 3 m/s^2 showed reductions of 19-20 dB(A) compared to conventional E-Chains®.



Light-weight and super-silent in small spaces - System E3



During long-term tests the System E3 with the spring band connector easily passes 15 million cycles at a bending radius of 44 mm and an acceleration of 4 g

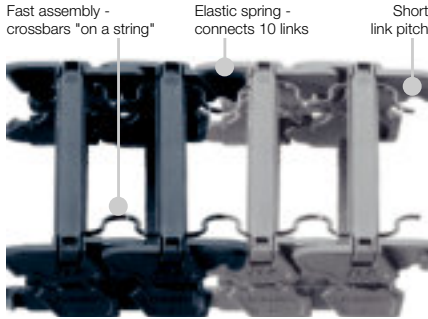

E3 = E-Chains® with 3 different elements in one link:

- U-shaped link body
- Spring element
- Crossbars "on a string"

E3: System for highly dynamic applications

Cycle times in automation get shorter, while demands for low noise and vibration levels are increasing. For the broad range of small size E-Chain® applications, igus® now introduces the System E3, that fully meets those requirements:

- Extremely low-noise operation - max. 38 dB(A)
- Elastic, dampening connector strip replaces pins and bores
- Modular 3-piece link design
- Cost effective cross bar-, separator and connector modules
- Fast an easy cable access due to zipper opening mechanism
- Good unsupported strength due to solid, interlocking side links
- Easy lengthening and shortening
- Also suits flat cables
- Accessories: Separators, integrated strain relief, mounting brackets
- You can find more technical data about the material, chemical resistance, temperatures ► **chapter Design, from page 1.38**

Selection table

Series	Inner height <i>hi</i> [mm]	Inner width <i>Bi</i> [mm]	Outer width <i>Ba</i> [mm]	Outer height <i>ha</i> [mm]	Bending radius <i>R</i> [mm]	Unsupported length max. [m]	Page
E3.10.	10	20 - 60	32 - 72	15	15 - 48	≈ 0,75	8.10
E3.15.	15	20 - 60	32 - 72	20	32 - 75	≈ 0,90	8.14
E3.22.	22	20 - 60	32 - 72	27	44 - 75	≈ 1,20	8.18

System E3 | 3-piece E-Chain®

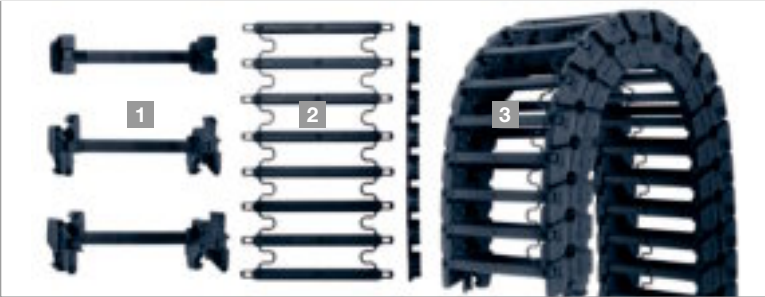

The abbreviation "E3" stands for an E-Chain® consisting of three basic elements:

- ❶ Chain link body
- ❷ Zipper style opening lids
- ❸ Separator module

System E3 | Opening | Closing



Zipper style opening lids on a band for quick and easy installation - This E-ChainSystem® allows faster assembling times. Opening and closing the E-Chain® is made by "zipperbars on a thread"

System E3 | Interior Separation | Strain Relief



Vertical separators on a band divide carrier space - Five separators in one thread are simultaneously mounted on the crossbars



The universal strain relief can be individually matched to the chain width. You can fix the E-Chain® on the fixed end with brackets (option)



Price index



*Noise test values: max. 38 dB(A) -
Values determined at the igus® test-
lab acc. to DIN 45635 (v = 1,8 m/s)



IPA classification - Report IG0704-400: ISO
Class 1, according to standard DIN EN ISO
14644-1 for E3, Series E3.15.040.075.0 (at
v = 0.5 m/s, 1 m/s, 2 m/s)



Special equipment:
Electrically conductive
ESD/ATEX version upon request



Rapid assembly time with "zipperbars on a strip"

**When to use the Series E3.10:**

- If a low-noise, vibration-free version is required
- At very high speeds and/or accelerations
(Theoretically up to 100 g or 1000 m/s)
- Hard-wearing E-Chain® (more than 50 million
cycles without abrasion)
- If a very light E-Chain® is required (up to 40%
lighter than a comparable E2-E-Chain®)
- For the use of flat cables
- For small bending radii and small spaces
- If easy filling and assembly is required
- Minimal abrasion
(e.g. cleanroom applications)

**When not to use it:**

- If a particularly low-cost,
snap-open solution is required
- ▶ Series E/Z06 Easy Chain®, page 3.20
- If a simple, non snap-open E-Chain® is required
- ▶ Series 05 E2 micro, page 5.22

- ① Smooth running, due to the igus® approved
"E6-Principle", 38db(A) max.*
- ② For high speed and high accelerations
- ③ Small pitch
- ④ 3-piece Design
- ⑤ Modular design- opening crossbars,
interior separation and link all in one band
- ⑥ Easy cable access due to
fast zip-open mechanism
- ⑦ Easy shortening/lengthening
- ⑧ Suits flat cables
- ⑨ Accessories, such as interior separations, strain
relief and mounting bracket, are available

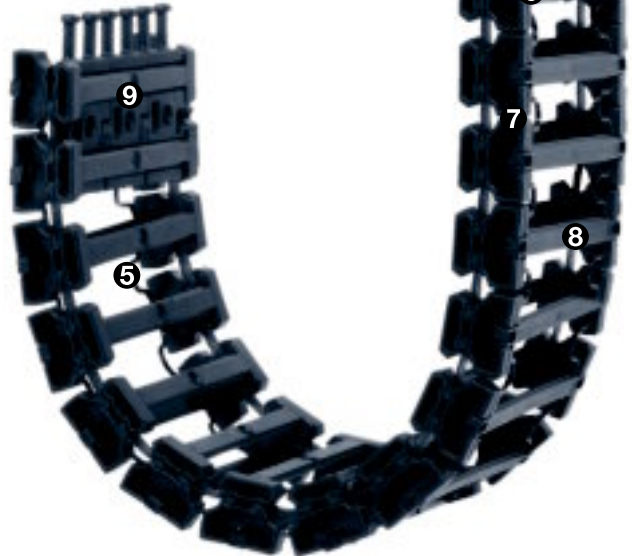
**Order example complete E-Chain®**Please indicate chain-lengths or number of links **Example: 1 m or 60 links**1 m **E3.10.060.015.0**
E-Chain®
with 2 separators **E3.10.11** assembled every 2" link

Interior separation
1 set **E3.10.060.12**
Mounting bracket

Unsupported length

FL_G = with straight upper run

FL_B = with permitted sag

Further information ► Design, page 1.12

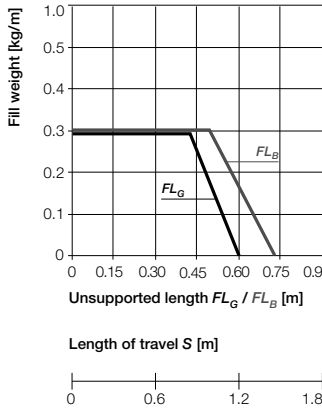
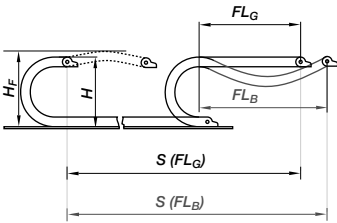

- S = Length of travel
- R = Bending radius
- H = Nominal clearance height
- H_F = Required clearance height
- D = Overlength E-Chain® radius in final position
- $K = \pi \cdot R + \text{"safety"}$

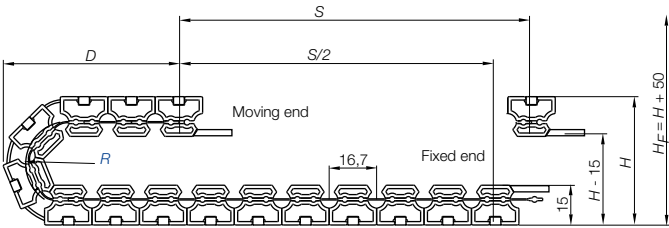

Pitch = 16,7 mm/link Links/m = 60 (1.002 mm) Chain length = $S/2 + K$

R	015	018	028	038	048
H	50	56	76	96	116
D	42	45	55	65	75
K	85	90	125	155	185



Short travels - unsupported

Unsupported E-Chains® feature positive camber over short travels. This must be accounted for when specifying the clearance height H_F . Please consult igus® if space is particularly restricted.

The required clearance height:
 $H_F = H + 50$ mm
 (with 0,1 kg/m fill weight)



System E3
 Inner height: 10 mm

Phone +49- (0) 22 03-96 49-800
 Fax +49- (0) 22 03-96 49-222



Technical Data

Speed / acceleration FL_G	max. 20 [m/s] / max. 200 [m/s ²]
Speed / acceleration FL_B	max. 3 [m/s] / max. 6 [m/s ²]
Gliding speed / acceleration (maximum)	upon request
permitted temperature °C	-40° up to +70° C
Flammability class	VDE 0304 IIC UL94 HB



Details of material properties
 ► page 1.38



► page 8.9

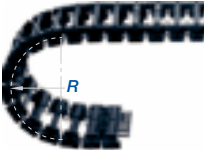
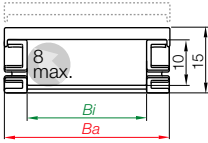

Series E3.10 - snap-open along outer radius

Part No.	Bi [mm]	Ba [mm]	R [mm]	Bending radii	Weight [kg/m]
E3.10.020.	20	32	015	018 028 038 048	~ 0,12
E3.10.040.	40	52	015	018 028 038 048	~ 0,15
E3.10.060.	60	72	015	018 028 038 048	~ 0,20

The bending radii **018** **028** **038** **048** are available upon request.

Delivery time: approx. 6-8 weeks after receipt of order!

Supplement Part No. with required radius. Example: E3.10.060.**015**.0

0 = standard color, other colors ▶ page 1.39 · Pitch = 16,7 mm/link - Links/m = 60

Part No. structure

E3.10.060.015.0



E3 | Series E3.10 | Accessories | Interior Separation

Vertical separator,
slotted (single)

unassembled E3.10.01

assembled E3.10.11



Vertical separators

Vertical separators are used if a vertical subdivision of the E-Chain® interior is required -

- Subdivision with vertical separator E3.10.11 (slotted 3 times)

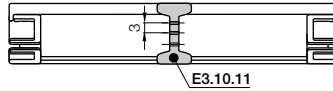



Mounting angle - Polymer

- For fastening the E-Chain® to the fixed end
- Simple fastening to base is possible
- Corrosion-resistant
- Various mounting options
- Easy to assemble

Moving end
E3.10...1

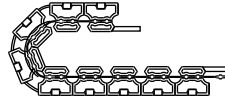

E3.10.....2
Fixed end

Example: Possible installation conditions for E3 mounting brackets

E3.10.....2
Fixed end

E3.10...1
Moving end

Dimensions and order configurations

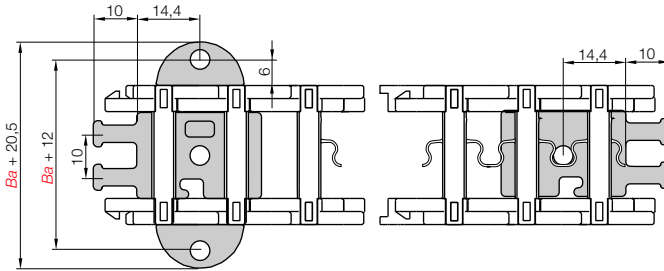

Part No. structure

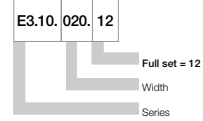

For E-Chain®	Part No. full set strain relief for both sides + 2 mounting angles	Part No. strain relief for both sides	Part No. mounting angle (single part)
E3.10.020.	▶ E3.10.020.12	E3.020.12	E3.10.00
E3.10.040.	▶ E3.10.040.12	E3.040.12	E3.10.00
E3.10.060.	▶ E3.10.060.12	E3.060.12	E3.10.00

Full set, for both ends:

E3.10. 020. 12

Single-part order:

E3.10. 020. 1

Moving end mounting bracket

E3.10. 020. 2

Fixed end mounting bracket

E3.10.XXX.12



E3 with strain relief for both sides and mounting angles

E3.00.020



Strain relief for both sides as single parts

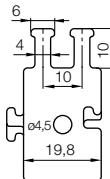

E3.10.00



Mounting angle as single part

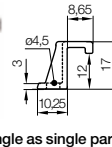

Phone +49- (0) 22 03-96 49-800
Fax +49- (0) 22 03-96 49-222



▶ page 8.9



Price index



*Noise test values: max. 38 dB(A) -
Values determined at the igus® test-
lab acc. to DIN 45635 (v = 1,8 m/s)



IPA classification - Report IG0704-400: ISO
Class 1, according to standard DIN EN ISO
14644-1 for E3, Series E3.15.040.075.0 (at
v = 0.5 m/s, 1 m/s, 2 m/s)



Special equipment:
Electrically conductive
ESD/ATEX version upon request



Rapid assembly time with "zipperbars on a strip"

**When to use the Series E3.15:**

- If a low-noise, vibration-free version is required
- At very high speeds and/or accelerations
(Theoretically up to 100 g or 1000 m/s)
- Hard-wearing E-Chain® (more than 50 million
cycles without abrasion)
- If a very light E-Chain® is required (up to 40%
lighter than a comparable E2-E-Chain®)
- For the use of flat cables
- For small bending radii and small spaces
- If easy filling and assembly is required
- Minimal abrasion
(e.g. cleanroom applications)

**When not to use it:**

- If a particularly low-cost,
snap-open solution is required
- ▶ Series E/Z08 Easy Chain®, page 3.28
- If a simple, non snap-open E-Chain® is required
- ▶ Serie 08 E2 micro, page 5.34

- 1 Smooth running, due to the igus® approved
"E6-Principle", 38db(A) max.*
- 2 For high speed and high accelerations
- 3 Small pitch
- 4 3-piece Design
- 5 Modular design- opening crossbars,
interior separation and link all in one band
- 6 Easy cable access due to
fast zip-open mechanism
- 7 Extensive external bearing surfaces and high load
capacity by means of interlocking bearing surfaces
- 8 Easy shortening/lengthening
- 9 Suits flat cables
- 10 Accessories, such as interior separations, strain
relief and mounting bracket, are available

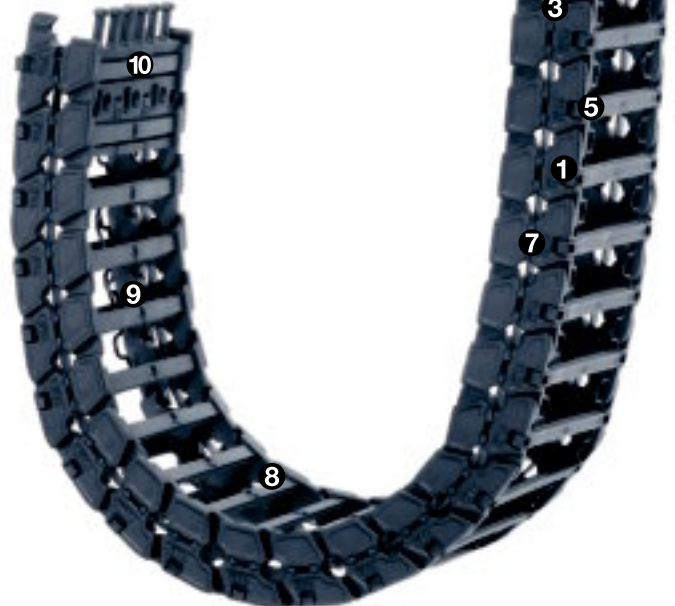
**Order example complete E-Chain®**Please indicate chain-lengths or number of links **Example: 1 m or 60 links**1 m **E3.15.060.032.0****E-Chain®**with 2 separators **E3.15.11** assembled every 2" link**Interior separation**1 set **E3.15.060.12****Mounting bracket**

Unsupported length

FL_G = with straight upper run

FL_B = with permitted sag

Further information ► **Design, page 1.12**

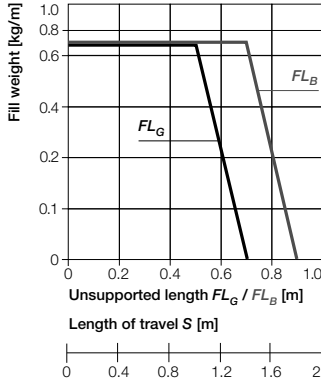
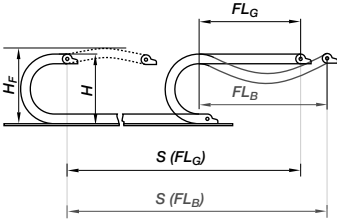

- S = Length of travel
- R = Bending radius
- H = Nominal clearance height
- H_F = Required clearance height
- D = Overlength E-Chain® radius in final position
- $K = \pi \cdot R + \text{"safety"}$

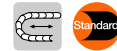
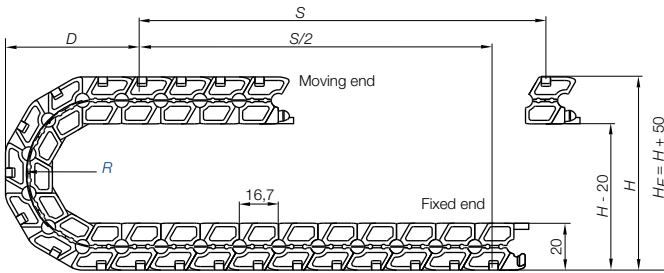

Short travels - unsupported

Unsupported E-Chains® feature positive camber over short travels. This must be accounted for when specifying the clearance height H_F . Please consult igus® if space is particularly restricted.

Pitch = 16,7 mm/link Links/m = 60 (1.002 mm) Chain length = $S/2 + K$

R	032	038	048	075
H	84	96	116	170
D	59	65	75	102
K	135	155	185	270

The required clearance height:
 $H_F = H + 50$ mm
 (with 0,2 kg/m fill weight)



System E3
 Inner height: 15 mm

Phone +49- (0) 22 03-96 49-800
 Fax +49- (0) 22 03-96 49-222



Technical Data

Speed / acceleration FL_G	max. 20 [m/s] / max. 200 [m/s ²]
Speed / acceleration FL_B	max. 3 [m/s] / max. 6 [m/s ²]
Gliding speed / acceleration (maximum)	upon request
permitted temperature °C	-40° up to +70° C
Flammability class	VDE 0304 IIC UL94 HB



Details of material properties
 ► page 1.38



► page 8.9

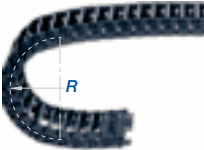
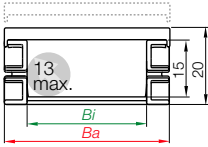

Part No. structure

E3.15.060.032.0



Series E3.15 - snap-open along outer radius

Part No.	B_i [mm]	B_a [mm]	R [mm]	Bending radii	Weight [kg/m]
E3.15.020.	20	32	032	038 048 075	~ 0,22
E3.15.040.	40	52	032	038 048 075	~ 0,25
E3.15.060.	60	72	032	038 048 075	~ 0,32

The bending radii 038 | 075 are available upon request for Series E3.15.020

Delivery time: approx. 6-8 weeks after receipt of order!

Supplement Part No. with required radius. Example: E3.15.060.032.0

0 = standard color, other colors ► page 1.39 · Pitch = 16,7 mm/link - Links/m = 60



E3 | Series E3.15 | Accessories | Interior Separation

Vertical separator,
slotted (single)

unassembled E3.15.01

assembled E3.15.11

Vertical separator
on a strip

unassembled E3.15.01.10

assembled E3.15.11.10



Vertical separators

Vertical separators are used if a vertical subdivision of the E-Chain® interior is required -

- Subdivision with vertical separator E3.15.11 (slotted 3 times)
- Five vertical separators altogether on one strip over ten chain links are mounted on the opening crossbars. In this way, controlled chambers are formed, which prevent the sensitive electrical circuit from outage

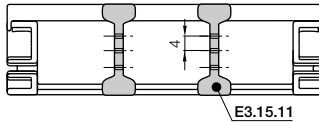



Mounting angle - Polymer

- For fastening the E-Chain® to the fixed end
- Simple fastening to base is possible
- Corrosion-resistant
- Various mounting options
- Easy to assemble

Moving end
E3.15...1

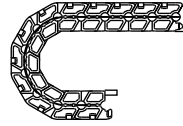

E3.15.....2
Fixed end

Example: Possible installation conditions for E3 mounting brackets

E3.15.....2
Fixed end

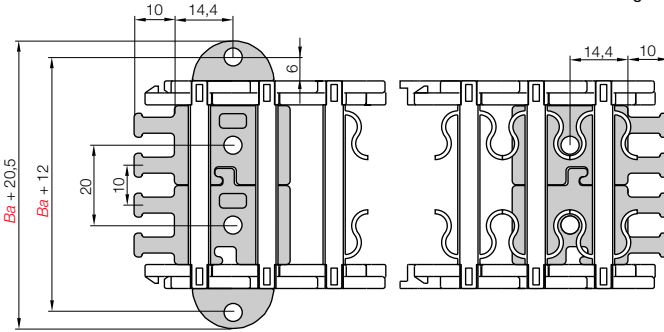

E3.15...1
Moving end

Dimensions and order configurations

Part No. structure

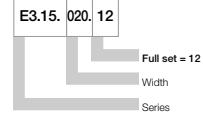

For E-Chain®	Part No. full set strain relief for both sides + 2 mounting angles	Part No. strain relief for both sides	Part No. mounting angle (single part)
E3.15.020.	▶ E3.15.020.12	E3.020.12	E3.15.00
E3.15.040.	▶ E3.15.040.12	E3.040.12	E3.15.00
E3.15.060.	▶ E3.15.060.12	E3.060.12	E3.15.00

Full set, for both ends:

E3.15. 020. 12

Single-part order:

E3.15. 020. 1

Moving end mounting bracket

E3.15. 020. 2

Fixed end mounting bracket

E3.15.XXX.12



E3 with strain relief for both sides and mounting angles

E3.00.020



Strain relief for both sides as single parts

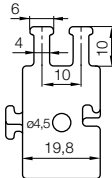

E3.15.00

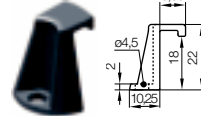

Mounting angle as single part

Phone +49- (0) 22 03-96 49-800
Fax +49- (0) 22 03-96 49-222





Price index



*Noise test values: max. 38 dB(A) -
Values determined at the igus® test-
lab acc. to DIN 45635 (v = 1,8 m/s)



IPA classification - Report IG0704-400: ISO
Class 1, according to standard DIN EN ISO
14644-1 for E3, Series E3.15.040.075.0 (at
v = 0.5 m/s, 1 m/s, 2 m/s)



Special equipment:
Electrically conductive
ESD/ATEX version upon request



Rapid assembly time with "zipperbars on a strip"

**When to use the Series E3.22:**

- If a low-noise, vibration-free version is required
- At very high speeds and/or accelerations
(Theoretically up to 100 g or 1000 m/s)
- Hard-wearing E-Chain® (more than 50 million
cycles without abrasion)
- If a very light E-Chain® is required (up to 40%
lighter than a comparable E2-E-Chain®)
- For the use of flat cables
- For small bending radii and small spaces
- If easy filling and assembly is required
- Minimal abrasion
(e.g. cleanroom applications)

**When not to use it:**

- If a particularly low-cost,
snap-open solution is required
- ▶ Series E/Z14 Easy Chain®, page 3.32
- If a simple, non snap-open E-Chain® is required
- ▶ Series 1400/1450/1480/1500 E2/000, page 5.92

E3 | Series E3.22

- 1 Smooth running, due to the igus® approved
"E6-Principle", 38dB(A) max.*
- 2 For high speed and high accelerations
- 3 Small pitch
- 4 3-piece Design
- 5 Modular design- opening crossbars,
interior separation and link all in one band
- 6 Easy cable access due to
fast zip-open mechanism
- 7 Extensive external bearing surfaces and high load
capacity by means of interlocking bearing surfaces
- 8 Easy shortening/lengthening
- 9 Suits flat cables
- 10 Accessories, such as interior separations, strain
relief and mounting bracket, are available

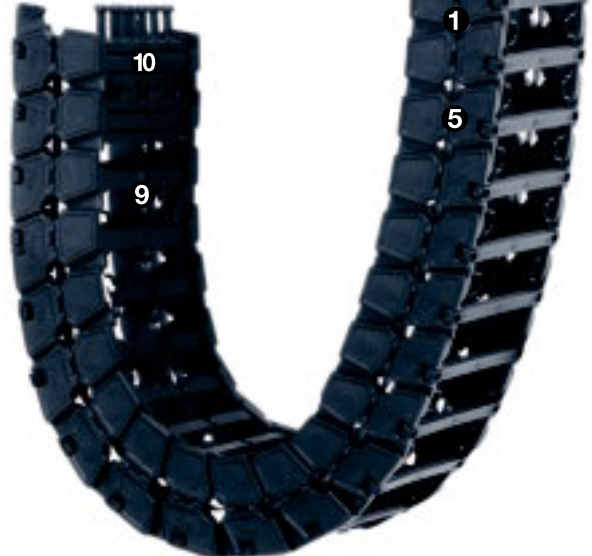
**Order example complete E-Chain®**Please indicate chain-lengths or number of links **Example: 1 m or 60 links**1 m **E3.22.060.044.0****E-Chain®**with 2 separators **E3.22.11** assembled every 2" link**Interior separation**1 set **E3.22.060.12****Mounting bracket**

Unsupported length

FL_G = with straight upper run

FL_B = with permitted sag

Further information ► **Design, page 1.12**

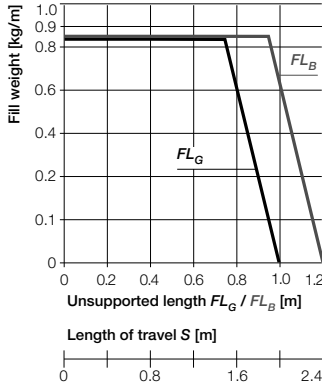
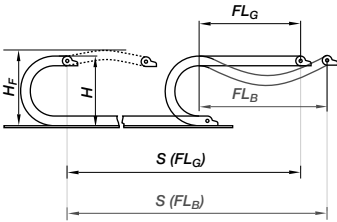

- S = Length of travel
- R = Bending radius
- H = Nominal clearance height
- H_F = Required clearance height
- D = Overlength E-Chain® radius in final position
- $K = \pi \cdot R + \text{"safety"}$

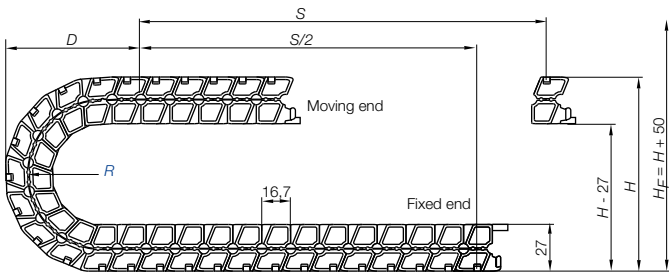

Pitch = 16,7 mm/link Links/m = 60 (1.002 mm) Chain length = $S/2 + K$

R	044	050	075
H	114	126	176
D	74	80	105
K	175	195	270



Short travels - unsupported

Unsupported E-Chains® feature positive camber over short travels. This must be accounted for when specifying the clearance height H_F . Please consult igus® if space is particularly restricted.

The required clearance height:
 $H_F = H + 50$ mm
 (with 0,3 kg/m fill weight)



System E3
 Inner height: 22 mm

Phone +49- (0) 22 03-96 49-800
 Fax +49- (0) 22 03-96 49-222



Technical Data

Speed / acceleration FL_G	max. 20 [m/s] / max. 200 [m/s ²]
Speed / acceleration FL_B	max. 3 [m/s] / max. 6 [m/s ²]
Gliding speed / acceleration (maximum)	upon request
permitted temperature °C	-40° up to +70° C
Flammability class	VDE 0304 IIC UL94 HB



Details of material properties
 ► page 1.38

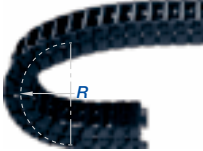
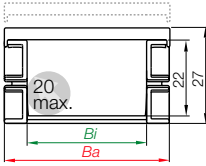

Part No. structure

E3.22.060.044.0



Series E3.22 - snap-open along outer radius

Part No.	Bi [mm]	Ba [mm]	R [mm]	Bending radii	Weight [kg/m]
E3.22.020.□.0	20	32	044	050 075	~ 0,30
E3.22.040.□.0	40	52	044	050 075	~ 0,32
E3.22.060.□.0	60	72	044	050 075	~ 0,41

The bending radius **050** is available upon request for Series E3.22.060

Delivery time: approx. 6-8 weeks after receipt of order!

Supplement Part No. with required radius. Example: E3.22.060.044.0

0 = standard color, other colors ► page 1.39 · Pitch = 16,7 mm/link - Links/m = 60



E3 | Series E3.22 | Accessories | Interior Separation

Vertical separator,
slotted (single)

unassembled E3.22.01

assembled E3.22.11



Vertical separators

Vertical separators are used if a vertical subdivision of the E-Chain® interior is required -

- Subdivision with vertical separator E3.22.11 (slotted 3 times)

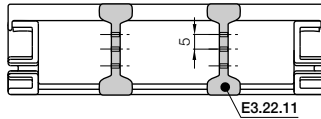



Mounting angle - Polymer

- For fastening the E-Chain® to the fixed end
- Simple fastening to base is possible
- Corrosion-resistant
- Various mounting options
- Easy to assemble

Moving end
E3.22...1

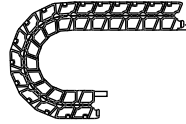

E3.22.....2
Fixed end

Example: Possible installation conditions for E3 mounting brackets

E3.22.....2
Fixed end

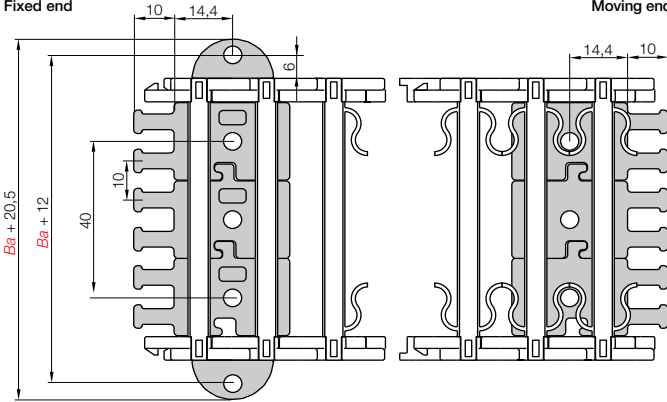

E3.22...1
Moving end

Dimensions and order configurations

Part No. structure

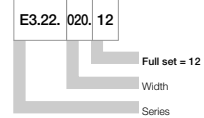

For E-Chain®	Part No. full set strain relief for both sides + 2 mounting angles	Part No. strain relief for both sides	Part No. mounting angle (single part)
E3.22.020.	▶ E3.22.020.12	E3.020.12	E3.22.00
E3.22.040.	▶ E3.22.040.12	E3.040.12	E3.22.00
E3.22.060.	▶ E3.22.060.12	E3.060.12	E3.22.00

Full set, for both ends:

E3.22. 020. 12

Single-part order:

E3.22. 020. 1

Moving end mounting bracket

E3.22. 020. 2

Fixed end mounting bracket

E3.22.XXX.12



E3 with strain relief for both sides and mounting angles

E3.00.020



Strain relief for both sides as single parts

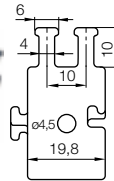

E3.22.00



Mounting angle as single part

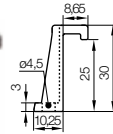

Phone +49- (0) 22 03-96 49-800
Fax +49- (0) 22 03-96 49-222



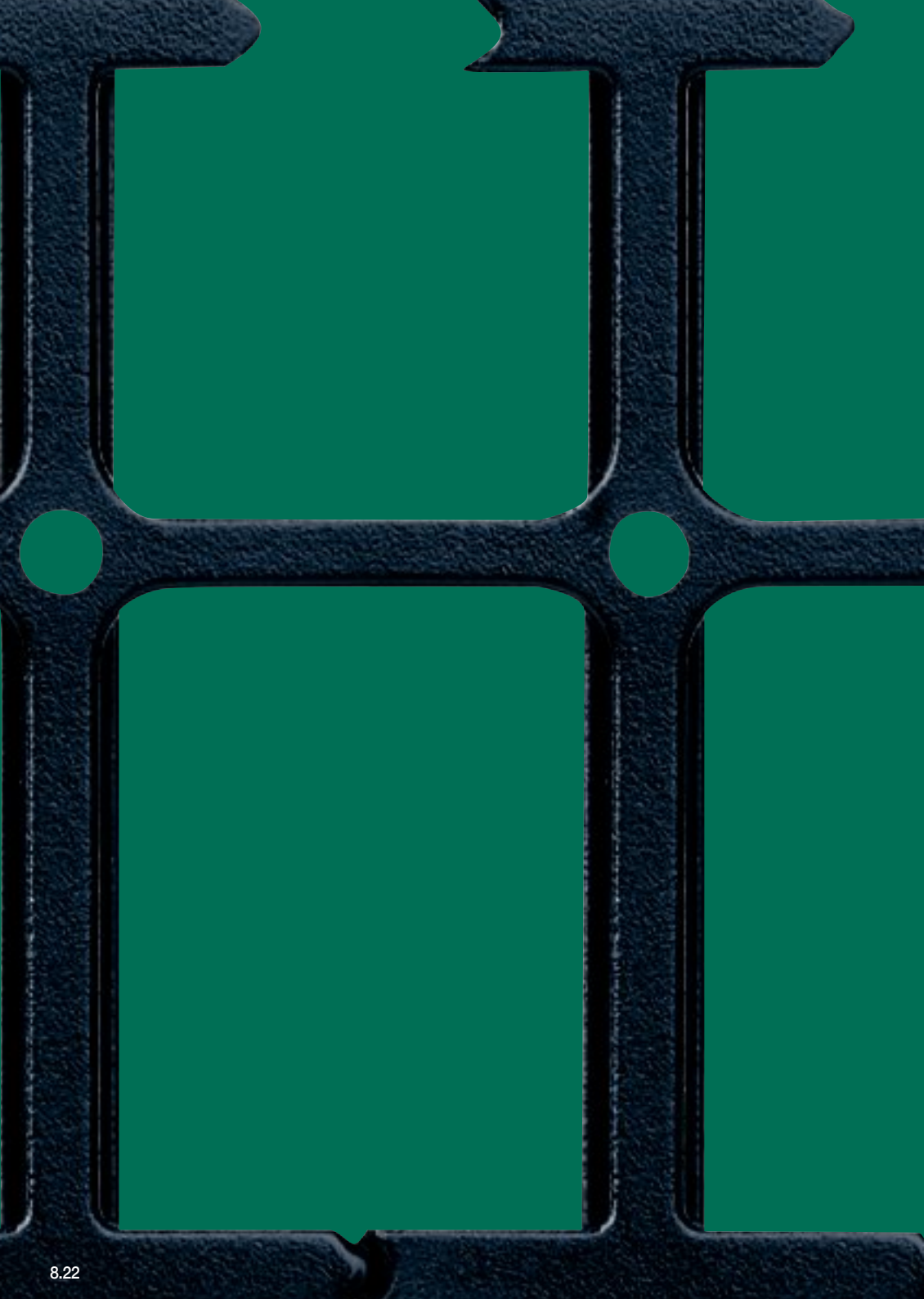



T3

System T3 - Highly flexible, low-vibration band chain

The E3-System combines low-noise operation, low sound level, simple installation and economy. The side plates that can be plugged into each other replace the conventional pin and bore connection and prevent relative movements between the joints, giving an almost complete freedom from wear. By the novel geometrical shape of the T band, hardly any polygon effect is generated during operation. The T band operates in a very smooth arc giving extremely low vibration and noise. In order to reduce the manufacturing and installation costs, the T band is mounted in a length of 8 chain links. Due to its low mass, the igus® T band, combined with high speeds and accelerations, is suitable for applications with low fill weights and short strokes.

Typical industries and applications

- Printer and plotter
- Cleanroom applications
- Production and processing of semiconductors
- Optics
- Automatic insertion machines
- Measuring technology



igus® tests at 1 m measuring distance: = 33 dB(A)
for T3.29.050.038.0 at $v = 1$ m/s und 26.5 dB(A)
basic sound level



Cleanroom test
upon request





Extremely low noise - System T3 tests in the igus® lab at 1 m measuring distance showed a value of ~ 33 dB(A) at 26.5 dB(A) basic sound level for Series T3.29.050.038



Testing facility at the igus® laboratory System T3 - ideal for high accelerations and short strokes

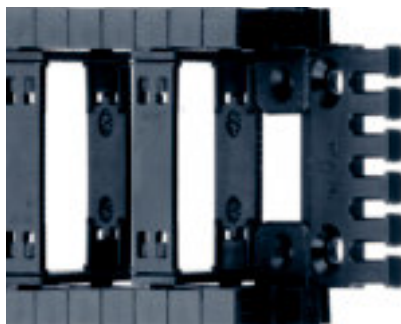

igus® System T3 T band chain - Inner height 29 mm

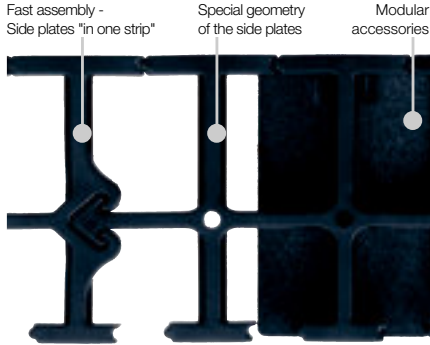

T3: E-Chain® band or highly dynamic applications

In the development of the 3-piece, T-shaped band chain "T3", the main focus was on minimum operational noise with lowest cost. This is achieved by the side-plate band consisting of 8 chain links in one piece, as well as the use of existing components of the popular E6 range. The T3 band chain is extremely flexible and runs "round" due to the special geometry. The omission of a pin and bore connection means the T3 band chain features extremely low abrasion and wear and hence is good for cleanroom applications.

- Extremely low noise and low vibration
- Low-priced E-Chain® for simple applications
- For high speeds and accelerations
- Very low weight
- Hardly any abrasion
- For short strokes
- Accessories: Separators, integrated strain relief, mounting brackets
- You can find more technical data about the material, chemical resistance, temperatures ► [chapter Design, from page 1.38](#)

Selection table

Series	Inner height <i>hi</i> [mm]	Inner width <i>Bi</i> [mm]	Outer width <i>Ba</i> [mm]	Outer height <i>ha</i> [mm]	Bending radius <i>R</i> [mm]	Unsupported length max. [m]	Page
T3.29.	29	30 - 120	55 - 145	35	038	≈ 1,45	8.28

System T3 | 3-piece E-Chain®

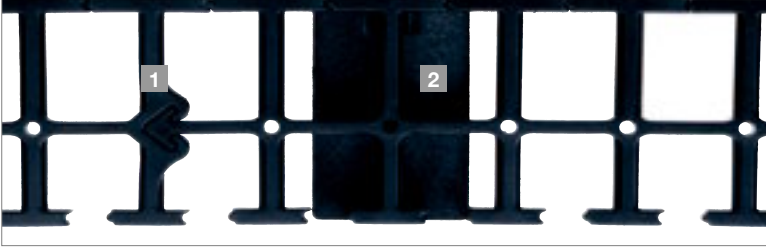

The abbreviation "T3" stands for a T-shaped E band, which consists of three basic elements:

- ❶ 2 side-plate bands (left/right)
- ❷ Separator element incl. separators

System T3 | Assembling



Side plates to be plugged into each other



Clip-on "interior separation clips"



System T3 enables quick installation times. The side plates can be simply plugged in



System T3 | Interior Separation | Strain Relief



Separators for dividing the chain cross section from the proven and tested E6 range (E6.29)

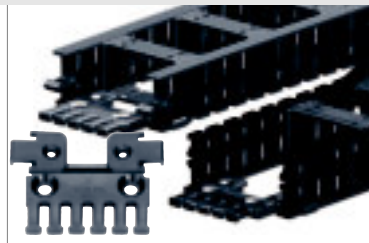

Universal strain relief through optional fixing bracket. You can fix the E-Chain® at the fixed end, if need be





Price index



Extremely low noise
Test results upon request



Clean-room
test upon request

- ① Side plates in one piece
- ② For high speed and high accelerations
- ③ Angle bracket for housing a strain relief tiwrap plate
- ④ 3-piece Design
- ⑤ Easy shortening
- ⑥ Accessories, such as interior separations and strain relief, are available
- ⑦ Low weight
- ⑧ Hardly any polygon effect



Fast assembly due to the side link strip



When to use the Series T3:

- At very high speeds and/or accelerations
- If a very light E-Chain® is required
- If a particularly low-cost E-Chain® is required
- For small bending radii and small spaces
- If easy filling and assembly is required
- Minimal abrasion (e.g. cleanroom applications)



When not to use it:

- When an E-Chain® is required for more fill weight
- ▶ Series E6.29, page 8.40
- When an enclosed E-Chain® is required for low noise operation
- ▶ Series R6.29, page 8.40

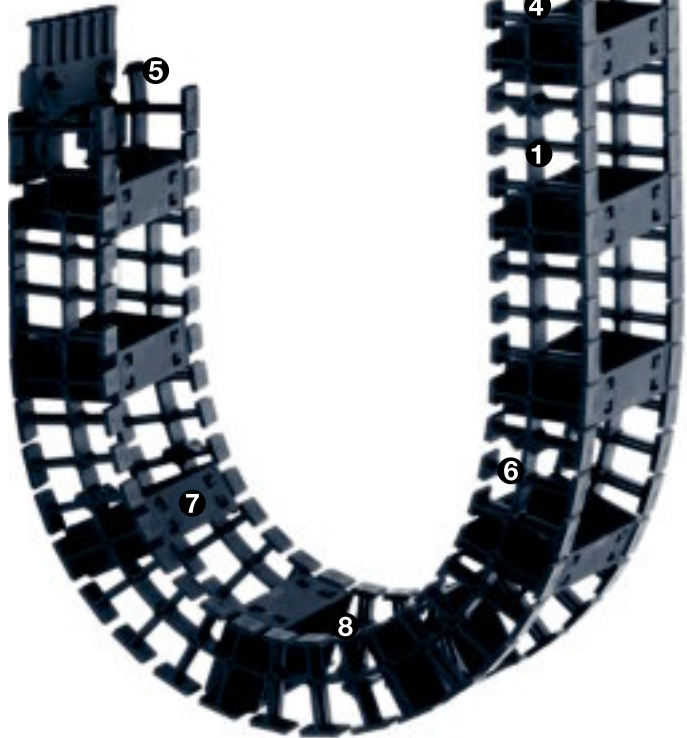

Order example complete E-Chain®

Please indicate chain-lengths or number of links Example: 1 m or 67 links

1 m T3.29.050.038.0



E-Chain®

with 2 separators E6.29.11 assembled every 2nd link

Interior separation

1 set T3.29.050.12



Mounting bracket



Unsupported length

FL_G = with straight upper run

FL_B = with permitted sag

Further information ► **Design, page 1.12**

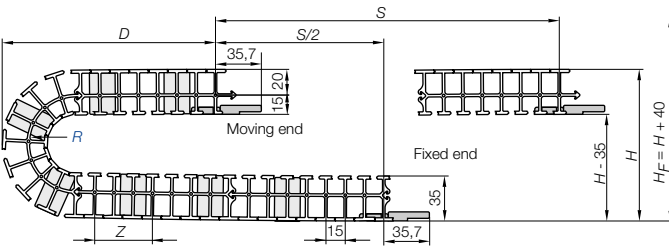
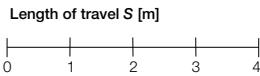
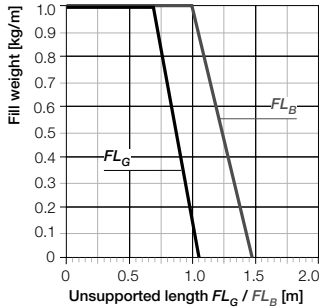
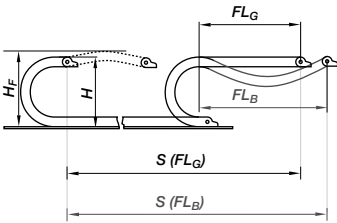

Pitch = 15 mm/link Links/m = 67 (1.005 mm) Chain length = $S/2 + K$

R (min.)	038
H (min.)	116
D	103
K	150

- S = Length of travel
- R = Bending radius
- H = Nominal clearance height
- H_F = Required clearance height
- D = Overlength E-Chain® radius in final position
- $K = \pi \cdot R + \text{"safety"}$
- Z = Distance of crossbars
(Standard: every 4th chain link)

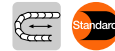

Short travels - unsupported

Unsupported E-Chains® feature positive camber over short travels. This must be accounted for when specifying the clearance height H_F . Please consult igus® if space is particularly restricted.

The required clearance height:
 $H_F = H + 40$ mm
(with 1,0 kg/m fill weight)

Speed / acceleration FL_G	max. 20 [m/s] / max. 200 [m/s ²]
Speed / acceleration FL_B	max. 3 [m/s] / max. 6 [m/s ²]
Gliding speed / acceleration (maximum)	upon request
Material - permitted temperature °C	-40° up to +70° C
Flammability class	VDE 0304 IIC UL94 HB

Technical Data



Details of material properties

► **page 1.38**



System T3
Inner height: 29 mm

Phone +49- (0) 22 03-96 49-800
Fax +49- (0) 22 03-96 49-222



► **page 8.27**

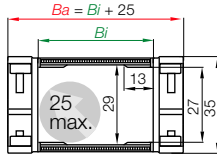

Part No. structure

T3.29.100.038.0

Series T3.29 - with crossbars every 2nd link

Part No.	B_j [mm]	B_a [mm]	R [mm]	Bending radii	Weight [kg/m]
T3.29.030.□.0	30	55	038		≈ 0,40
T3.29.040.□.0	40	65	038		≈ 0,42
T3.29.050.□.0	50	75	038		≈ 0,44
T3.29.060.□.0	60	85	038		≈ 0,46
T3.29.070.□.0	70	95	038		≈ 0,48
T3.29.080.□.0	80	105	038		≈ 0,50
T3.29.090.□.0	90	115	038		≈ 0,51
T3.29.100.□.0	100	125	038		≈ 0,53
T3.29.110.□.0	110	135	038		≈ 0,55
T3.29.120.□.0	120	145	038		≈ 0,57

Supplement Part No. with required radius. Example: T3.29.100.038.0

0 = standard color, other colors ► page 1.39 · Pitch = 15 mm/link · Links/m = 67



Interior separation elements

Distance "Z" for the interior separation elements of the T3 E-Chain"

Note: The first and last chain links should not be stuck with the interior separation elements!

As a standard, crossbars are mounted on every 4th chain link!

Part No. T3.29.100.038.0

For other distances, e.g. every 6th chain link, change the part number as follows:

Part No. T3.29.100.038.Z6.0

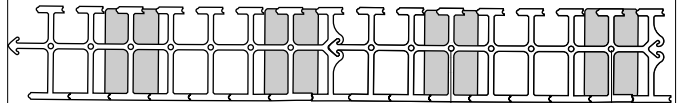

Distance "Z", crossbars mounted on every 4th chain link as standard

Z

Option 1: Vertical separators

Vertical separators are used if a vertical subdivision of the E-Chain® interior is required -

By standard vertical separators are assembled every 4th E-Chain® link!

- **Standard** subdivision with vertical separator E6.29.11* (slotted 5 times), for combinations with full-width shelf 111.X
- **Notch separator** E6.29.11.R (slotted 5 times) can be locked in 2 mm increments due to gaps on the crossbars. For side-mounted applications and combinations with full-width shelf 111.X
- **Middle plate*** E6.29.12 for combinations with side plate E6.29.13, full-width shelf 221.X and shelf 2210.X
- **Strain relief separator** E6.29.12.Z (slotted 5 times), can be integrated into the mounting bracket and can be placed there at any point

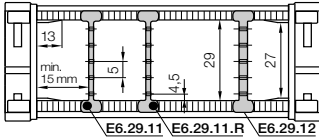

Vert. separator, slotted*
unassembled E6.29.01
assembled E6.29.11



Notch separator
unassembled E6.29.01.R
assembled E6.29.11.R



Middle plate*
unassembled E6.29.02
assembled E6.29.12



Strain relief separator
unassembled E6.29.02.Z
assembled E6.29.12.Z



*no minimum space required!

Option 2: Full-width shelves

For applications involving many thin cables with similar or identical diameters

- **Full-width shelf 111.X** for combinations with vertical separator E6.29.11 and notch separator E6.29.11.R
- **Full-width shelf 221.X** for combinations with middle plate E6.29.12, strain relief separator E6.29.12.Z, and side plate E6.29.13

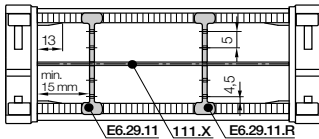

Width	Part No. unassembled	Part No. assembled
X [mm]	110.X	220.X
030	110.30	220.30
040	110.40	220.40
050	110.50	220.50
060	110.60	220.60
070	110.70	220.70

Width	Part No. unassembled	Part No. assembled
X [mm]	110.X	220.X
080	110.80	220.80
090	110.90	220.90
100	110.100	220.100
110	110.110	220.110
120	110.120	220.120

Full-width shelf

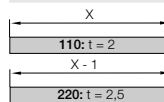

Option 3: Shelves

Shelves can be arranged elevator-shifted with different bottoms within the entire E-Chain® width

- **Shelf 2210.X** for combinations with middle plate E6.29.12, strain relief separator E6.29.12.Z and side plate E6.29.13

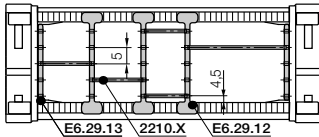

Width	Part No. unassembled	Part No. assembled
X [mm]	2200.18	2210.18
018	2200.18	2210.18
023	2200.23	2210.23
028	2200.28	2210.28
033	2200.33	2210.33
038	2200.38	2210.38
043	2200.43	2210.43

Width	Part No. unassembled	Part No. assembled
X [mm]	2200.48	2210.48
048	2200.48	2210.48
058	2200.58	2210.58
068	2200.68	2210.68
073	2200.73	2210.73
088	2200.88	2210.88
099	2200.99	2210.99

Side plate

unassembled E6.29.03
assembled E6.29.13



Shelf

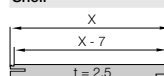

System T3
Inner height: 29 mm

Phone +49- (0) 22 03-96 49-800
Fax +49- (0) 22 03-96 49-222



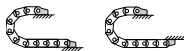

Example: Possible installation conditions for E3 mounting brackets



Plastic fastener

- Housing potential for strain relief tiwrap plate
- Firmly attached to the E-Chain®
- Minimized outer width
- Fastening of the E-Chain® possible on subsurface

Moving end
T3.29...2



T3.29...1
Fixed end

Dimensions and order configurations



Mounting angle, single

Part No. structure

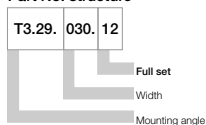

Full set, for both ends:

T3.29.030.12

Single-part order:

T3.29.030.1

Moving end mounting bracket

T3.29.030.2

Moving end mounting bracket

T3.29...2
Moving end

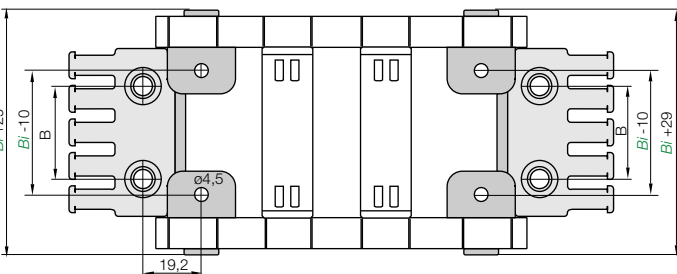

T3.29...1
Fixed end

For	Part No.
E-Chain®	full set
T3.29.030	T3.29.030.12
T3.29.040	T3.29.040.12
T3.29.050	T3.29.050.12
T3.29.060	T3.29.060.12
T3.29.070	T3.29.070.12

For	Part No.
E-Chain®	full set
T3.29.080	T3.29.080.12
T3.29.090	T3.29.090.12
T3.29.100	T3.29.100.12
T3.29.110	T3.29.110.12
T3.29.120	T3.29.120.12

Phone +49- (0) 22 03-96 49-800
Fax +49- (0) 22 03-96 49-222

igus® GmbH
51147 Cologne

Internet: www.igus.eu
E-mail: info@igus.de

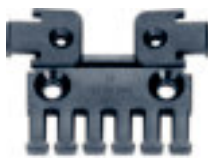

Mounting angle mit strain relief

T3 | Series T3.29 | Accessories | Strain Relief

igus® Chainfix tiwrap plate as individual part

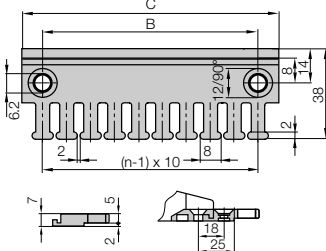

Tiewrap plate	n Number of teeth	Dim. C [mm]	Dim. B [mm]
2020.ZB	3	30	15
2030.ZB	4	40	20
2040.ZB	5	50	30
2050.ZB	6	60	40
2070.ZB	8	80	60
2090.ZB = (2030.ZB + 2040.ZB)	9	90	-
2100.ZB	10	100	80
2125.ZB = (2050.ZB + 2050.ZB)	12	120	-

Strain relief separator

Separator with integrated strain relief for the use in the first or last chain link. Individual part for the manufacturing of switchgear cabinets or for the assembly of machines. Easy to assemble without any screws ► chapter 10.

Part No.	Number of teeth	For Series
E6.29.02.Z	2 one side	T3.29 E-Chain®

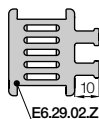

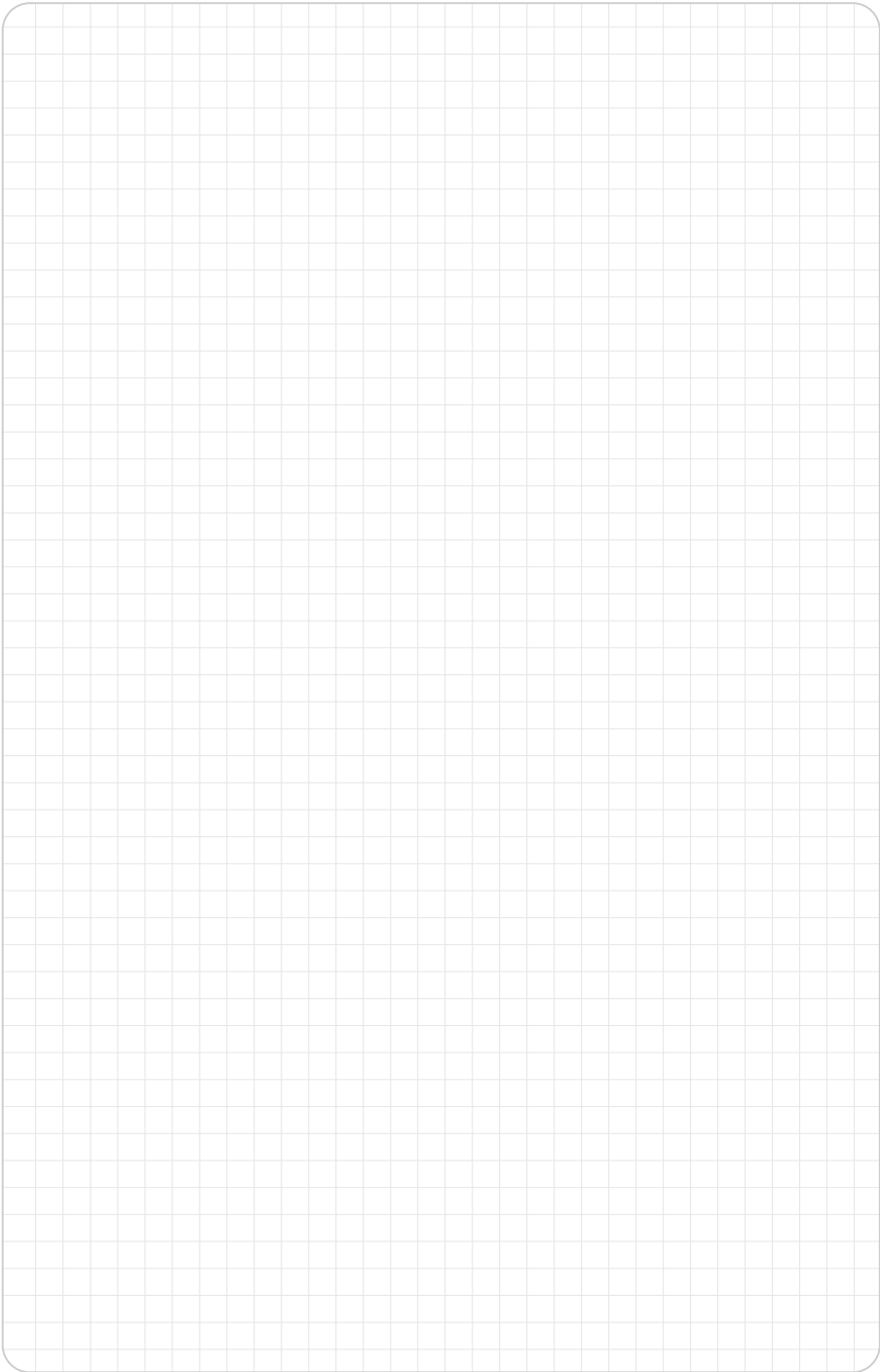

System T3
Inner height: 29 mm

Phone +49- (0) 22 03-96 49-800
Fax +49- (0) 22 03-96 49-222







E6

E6 - 6-piece E-Chains® - Extremely low- noise, minimum vibrations

The E6 Series offers numerous advantages in addition to long life cycles. It provides extremely quiet, low-vibration operation. It minimizes the polygon effect which can occur during the rolling motion of an E-Chain®. The ultra-low noise levels have been confirmed in a recent report by the Rheinland Technical Inspection Agency. Our extensive delivery program offers the right chain size for any application; a wide range of interior separators are also available. The same applies to the mounting brackets. .

Typical industries and applications

- Cleanroom
- Printing machines
- Handling & robot
- Machine Tools
- Measuring machines
- Semiconductor industries
- Medical industries
- Electronic industries
- General machinery



System E6 - Extremely
low noise - TÜV certified



System E6 -
6-piece link-design



LEVEL 1 absorption confirmed by IPA-Fraunhofer-Institut according to SEMI E78-0998 for the E6 standard material. Special material "Igurmid ESD" for ESD/ATEX applications available on request. Continuously constant conductance value as there are no pin-bore connection (no air gaps).





A linear drive provides for highly dynamic feed of PCBs. This system is twice as fast as handling units with a toothed-belt drive; designed to withstand high dynamic loads, the E6 E-Chains® ensure a supply of power, coolant and control data with ultra-low noise and vibration

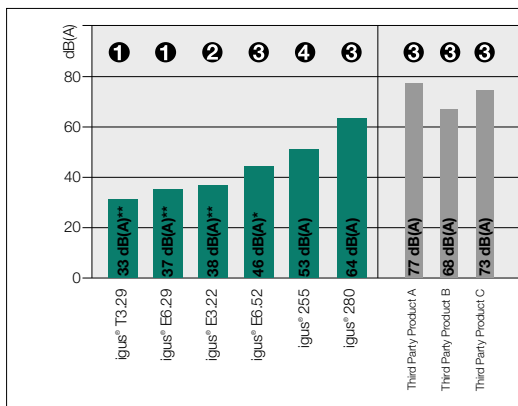

Averaging of the corrected sound pressure levels in dB(A), rounded

- ① unsupported 1,0 m/s
- ② unsupported 1,8 m/s
- ③ unsupported 2,0 m/s
- ④ unsupported 1,5 m/s

* Measurement by the TÜV Rheinland 46 dB(A) with 10 dB(A) outer noise

** Values permitted in the igus® laboratory according to DIN45635



IPA classification - Report IG0704-400:

- Special material "cleanroom" - **Class 1 according to standard DIN EN ISO 14644-1** - Note: None of the classes corresponding to the DIN EN ISO 14644-1 Class 1 is included in the US standard at $v = 0.5 \text{ m/s}$, $a = 1.0 \text{ m/s}^2$ - Series E6.29.060.150.0.CR
- Standard material - **Class 3 according to standard DIN EN ISO 14644-1** (according to US Fed. Stand. 209E, Class 1) at $v = 0.5 \text{ m/s}$, $a = 1.0 \text{ m/s}^2$ Series E6.29.060.150.0 and $v = 1 \text{ m/s}$, $a = 2 \text{ m/s}^2$ Series E6.29.050.055.0 with inserted cables CF34.15.04, CF9.05.12, CF11.02.01.02.PBA.LC.D

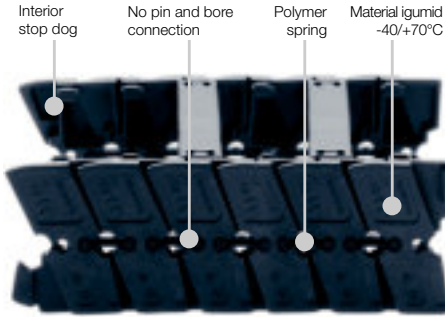

E6: E-Chain® with 6 pieces per link

- Extremely low-noise operation - 37 dB(A)¹ depending on the speed
- Snap-open lids along both radii
- Available as closed tube for some types
- High stability "unsupported"
- For high speed and high accelerations
- Modular design, can be shortened and lengthened
- Minimum vibrations, high stability and tensile strength
- Various interior separations available
- KMA mounting brackets available with integrated strain relief
- E6 adapter link - for gliding applications - minimizes excess lengths in end positions - quick and easy assembly
- You can find more technical data about the material, chemical resistance, temperatures ► **chapter Design, from page 1.38**

Selection table

Series	Inner height <i>hi</i> [mm]	Inner width <i>Bi</i> [mm]	Outer width <i>Ba</i> [mm]	Outer height <i>ha</i> [mm]	Bending radius <i>R</i> [mm]	Unsupported length max. [m]	Page
E6.29	29	30 - 120	46 - 136	35	55 - 150	≈ 1,75	8.40
R6.29	28	30 - 120	46 - 136	35	55 - 150	≈ 1,75	8.46
E6.35	35	30 - 120	50 - 140	42	55 - 100	≈ 1,9	8.50
E6.40	40	40 - 300	60 - 320	54	63 - 200	≈ 2,75	8.56
R6.40	40	62	82	54	63 - 200	≈ 2,75	8.62
E6.52	52	40 - 300	64 - 324	65	75 - 250	≈ 3,0	8.66
R6.52	52	50 - 175	74 - 199	65	75 - 250	≈ 3,0	8.72
E6.62	62	50 - 400	86 - 436	84	115 - 350	≈ 4,0	8.76
E6.80L	80	112 - 550	140 - 578	108	175	≈ 2,5	8.82
E6.80	80	50 - 600	100 - 650	108	150 - 450	≈ 5,25	8.88

Selected noise tests - External noise corrected measurement values

E-Chain® Series	Averaging of the corrected sound pressure levels	Test method
igus® Series E6.29*	≈ 37 dB(A)	unsupported v = 1,0 m/s
igus® Series E6.52*	≈ 41 dB(A)	unsupported, side mounted v = 0,5 m/s
igus® Series E6.52	≈ 46 dB(A)	unsupported v = 2,0 m/s
Chain 1 Third-party product	≈ 77 dB(A)	unsupported v = 2,0 m/s
Chain 2 Third-party product	≈ 68 dB(A)	unsupported v = 2,0 m/s
Chain 3 Third-party product	≈ 73 dB(A)	unsupported v = 2,0 m/s

Source: TÜV Rheinland *Source: igus® laboratory



Noise level ≤ 46 dB(A)

A measurement conducted by the Rhineland Technical Inspection Authority (TÜV Rheinland) in May 2002 indicates a value of ≤ 46 dB(A) at 2 m/s and with an unsupported length of 1.5 m with **Series E6.52.100.100.0**, and all this with at least 10 dB(A) sound pressure level generated by external noise. **We have received an official noise certificate from the Rhineland Technical Inspection Authority (TÜV Rheinland Berlin Brandenburg) and we are happy to provide you with a copy upon request.**



System E6 | E-Chain® | Assembling



1 Position side links...

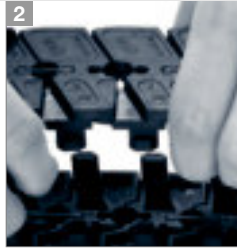

2 ... gently twist and snap in



3 Gently reinsert connector by using hammer



4 Position crossbars, push down and snap in

E-Tube | Assembling lids



1 Insert lid...



2 ...push down and snap in

System E6 | E-Chain® | Separating



1 Lever crossbars with screwdriver



2 Tap gently to remove connectors



3 Twist and...

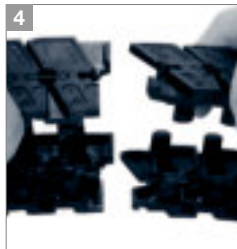

4 ...separate side links

E-Tube | Separating lids



1 Lever with screwdriver...



2 ...and remove lids by hand





Price index



Extremely low noise
Test results upon request



IPA certificate: Class 1, according to standard DIN EN ISO 14644-1 for the E6 system (Series E6.29.060.150.0.CR, $v = 0.5 \text{ m/s}$, $a = 1.0 \text{ m/s}^2$)



LEVEL 1 absorption confirmed by IPA-Fraunhofer-Institut according to SEMI E78-0998 for the E6 standard material



To close, push and click shut



When to use the Series E6.29:

- If a low-noise version is required
- At very high speeds and/or accelerations
- For enlarged thrusts and tensile forces
- For small bending radii
- If less vibration is required
- Minimal abrasion
(e.g. cleanroom applications)



When not to use it:

- Limited in side-mounted applications
▶ Series 2400/2500 E2/000, page 5.102
- No use with RBR (reverse bending radius)
▶ Series 2400/2500 E2/000, page 5.102
- No use with high additional loads
▶ Series 2400/2500 E2/000, page 5.102
- No use in dirty environments
▶ Series 2400/2500 E2/000, page 5.102

- ① No pin and bore connection
- ② Small pitch for low-noise, smooth operation
- ③ Very large gliding surfaces
- ④ Can be shortened or lengthened due to modular design
- ⑤ Increased inner height
- ⑥ Interior stop dog
- ⑦ KMA mounting brackets with attachment points on all sides (strain relief with separate tiewrap plates possible)
- ⑧ Strain relief separator E6.29.02.Z for the use in the first or last chain link
- ⑨ Series R6.29 - E-Tube-version available ▶ page 8.46

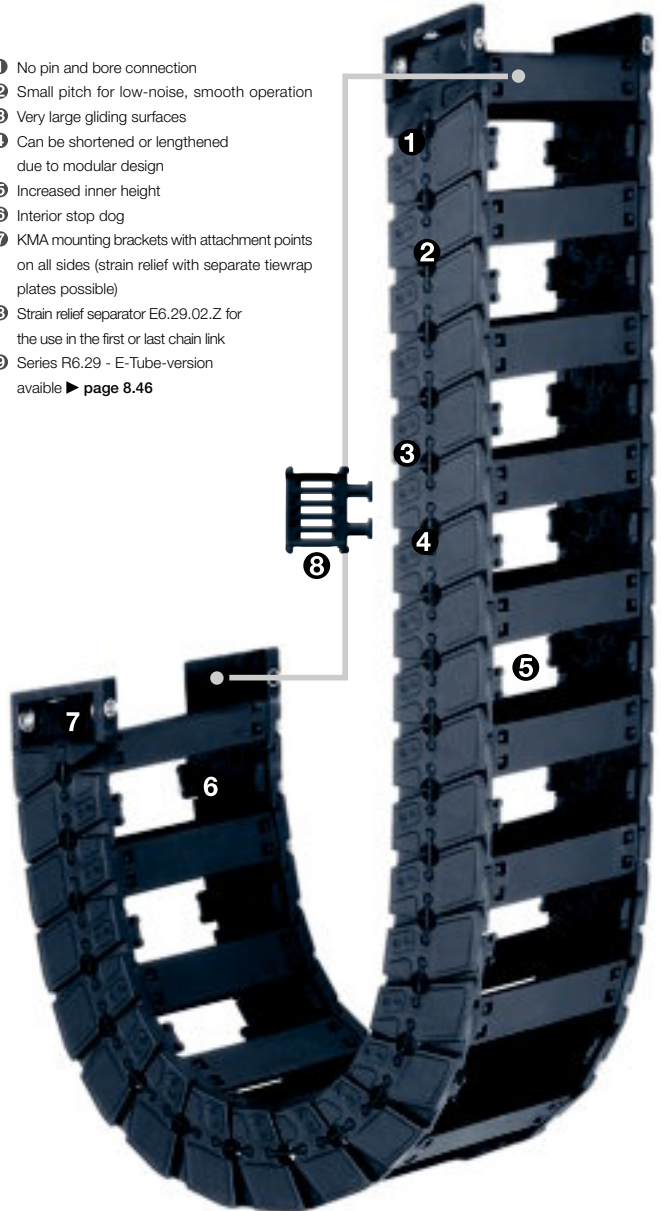

Order example complete E-Chain®

Please indicate chain-lengths or number of links Example: 2 m or 92 links

2 m E6.29.100.075.0



E-Chain®

with 2 separators E6.29.11 assembled every 2" link



Interior separation

1 set E6.290.100.12



Mounting bracket



Unsupported length

FL_G = with straight upper run

FL_B = with permitted sag

Further information ► **Design, page 1.12**

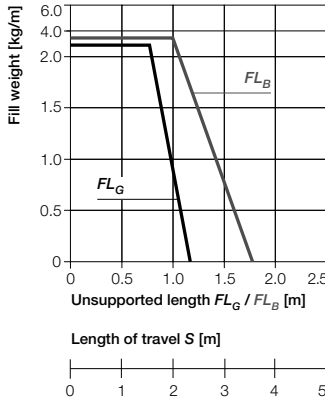
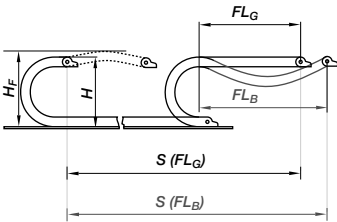

- S = Length of travel
- R = Bending radius
- H = Nominal clearance height
- H_F = Required clearance height
- D = Overlength E-Chain® radius in final position
- $K = \pi \cdot R + \text{"safety"}$

Other installation methods

- Vertical, hanging ≤ 30 m
- Vertical, standing ≤ 2 m
- Side mounted, unsupported = possible to a limited extent
- Unsupported length of upper run = upon request

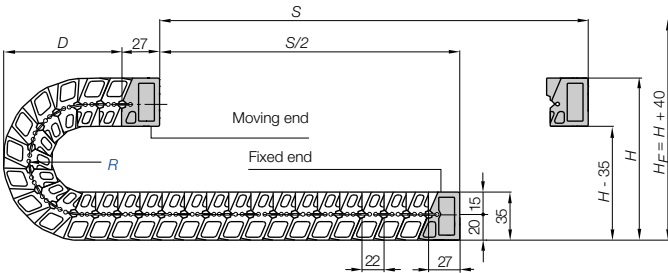

Pitch = 22 mm/link Links/m = 46 (1012 mm) Chain length = $S/2 + K$

R	055	075	100	150
H (min.)	150	190	240	340
D	97	117	142	192
K	220	280	360	520



Short travels - unsupported

Unsupported E-Chains® feature positive camber over short travels. This must be accounted for when specifying the clearance height H_F . Please consult igus® if space is particularly restricted.

The required clearance height:
 $H_F = H + 40$ mm
 (with 2,0 kg/m fill weight)

Speed / acceleration FL_G	max. 20 [m/s] / max. 200 [m/s ²]
Speed / acceleration FL_B	max. 3 [m/s] / max. 6 [m/s ²]
Gliding speed / acceleration (maximum)	upon request
permitted temperature °C	-40° up to +70° C
Flammability class	VDE 0304 IIC UL94 HB

Technical Data



Details of material properties

► **page 1.38**

29

System E6
Inner height: 29 mm

Phone +49- (0) 22 03-96 49-800
Fax +49- (0) 22 03-96 49-222

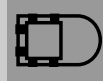

► **page 8.39**

For support of the lower run - **Support Tray tool kit** available ► **page 9.70**

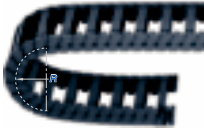
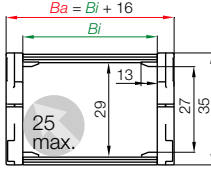
Series E6.29 - with crossbars every 2nd link

Part No.	B_i [mm]	B_a [mm]	R [mm]	Bending radii			Weight [kg/m]
E6.29.030.□.0	30	46	055	075	100	150	≈ 0,73
E6.29.040.□.0	40	56	055	075	100	150	≈ 0,75
E6.29.050.□.0	50	66	055	075	100	150	≈ 0,78
E6.29.060.□.0	60	76	055	075	100	150	≈ 0,80
E6.29.070.□.0	70	86	055	075	100	150	≈ 0,83
E6.29.080.□.0	80	96	055	075	100	150	≈ 0,85
E6.29.090.□.0	90	106	055	075	100	150	≈ 0,88
E6.29.100.□.0	100	116	055	075	100	150	≈ 0,90
E6.29.110.□.0	110	126	055	075	100	150	≈ 0,93
E6.29.120.□.0	120	136	055	075	100	150	≈ 0,95

Part No. structure

E6.29.100.100.0



Supplement Part No. with required radius. Example: E6.29.100.100.0

0 = standard color, other colors ▶ page 1.39 · Pitch = 22 mm/link - Links/m = 46

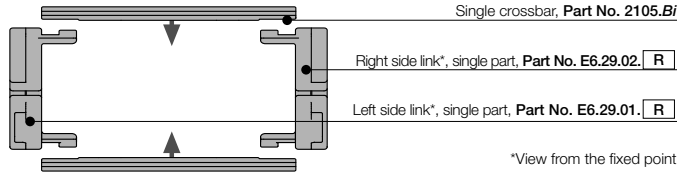

Part No. E-Chain® - links, single parts

Polymer spring as single part -
Part No. E6.29.140

Option 1: Vertical separators

Vertical separators are used if a vertical subdivision of the E-Chain® interior is required -

By standard vertical separators are assembled every other E-Chain® link

- **Standard** subdivision with vertical separator E6.29.11* (slotted 5 times), for combinations with full-width shelf 111.X
- **Notch separator** E6.29.11.R (slotted 5 times) can be locked in 2 mm increments due to gaps on the crossbars. For side-mounted applications and combinations with full-width shelf 111.X
- **Middle plate*** E6.29.12 (slotted 5 times) for combinations with side plate E6.29.13, full-width shelf 221.X and Shelf 220.X
- **Strain relief separator** E6.29.12.Z (slotted 5 times), can be integrated into the mounting bracket and can be placed there at any point

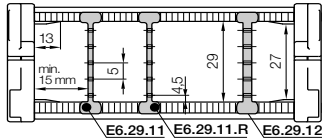

Vert. separator, slotted*
unassembled E6.29.01
assembled E6.29.11



Notch separator
unassembled E6.29.01.R
assembled E6.29.11.R



Middle plate*
unassembled E6.29.02
assembled E6.29.12



Strain relief separator
unassembled E6.29.02.Z
assembled E6.29.12.Z



*no minimum space required!

System E6
Inner height: 29 mm

Phone +49- (0) 22 03-96 49-800
Fax +49- (0) 22 03-96 49-222

Option 2: Full-width shelves

For applications involving many thin cables with similar or identical diameters

- **Full-width shelf 111.X** for combinations with vertical separator E6.29.11 and notch separator E6.29.11.R
- **Full-width shelf 221.X** for combinations with middle plate E6.29.12, strain relief separator E6.29.12.Z, and side plate E6.29.13

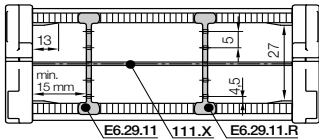

Width	Part No. unassembled	Part No. assembled
X [mm]	110.X	220.X
030	110.30	220.30
040	110.40	220.40
050	110.50	220.50
060	110.60	220.60
070	110.70	220.70

Width	Part No. unassembled	Part No. assembled
X [mm]	110.X	220.X
080	110.80	220.80
090	110.90	220.90
100	110.100	220.100
110	110.110	220.110
120	110.120	220.120

Full-width shelf

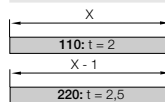

Option 3: Shelves

Shelves can be arranged elevator-shifted with different bottoms within the entire E-Chain® width

- **Shelf 220.X** for combinations with middle plate E6.29.12, strain relief separator E6.29.12.Z, and side plate E6.29.13

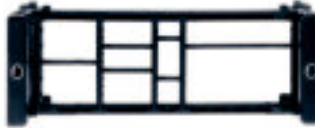
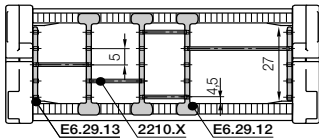

Width	Part No. unassembled	Part No. assembled
X [mm]	2200.18	2210.18
018	2200.18	2210.18
023	2200.23	2210.23
28	2200.28	2210.28
033	2200.33	2210.33
038	2200.38	2210.38
043	2200.43	2210.43

Width	Part No. unassembled	Part No. assembled
X [mm]	2200.48	2210.48
048	2200.48	2210.48
058	2200.58	2210.58
068	2200.68	2210.68
073	2200.73	2210.73
088	2200.88	2210.88
099	2200.99	2210.99

Side plate, slotted

unassembled E6.29.03
assembled E6.29.13



Shelf

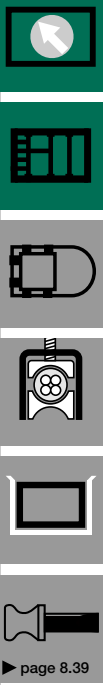
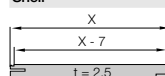



* KMA = Polymer Metal Mounting Bracket

Option KMA* - pivoting

- Bolted connection outside of chain cross-section
- Recommended for unsupported applications (for gliding applications please contact igus®)
- Confined installation conditions
- Universal mountable with attachment capability on all sides

Moving end
E6.290...2

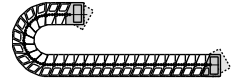

The attachment variants arising automatically by the choice of the KMA mounting bracket

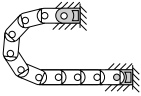

E6.290...1
Fixed end

Dimensions and order configurations

E6.290...2
Fixed end

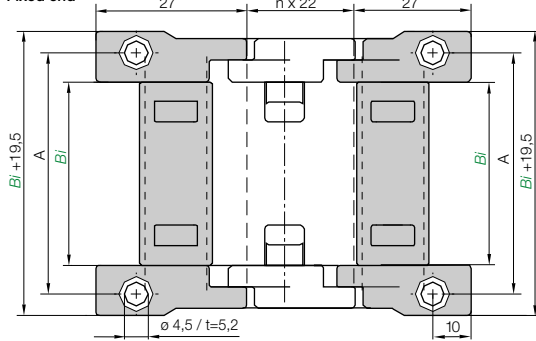

E6.290...1
Moving end

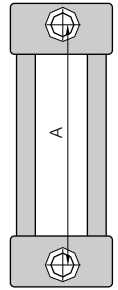

Part No. structure

E6.290.030.12



Full set, for both ends:

[E6.290.030.12](#)

Single-part order:

[E6.290.030.1](#)

Fixed end mounting bracket

[E6.290.030.2](#)

Moving end mounting bracket

For	Part No.	Dim. A
E-Chain®	full set	[mm]
E6.29.030 ▶	E6.290.030.12	40
E6.29.040 ▶	E6.290.040.12	50
E6.29.050 ▶	E6.290.050.12	60
E6.29.060 ▶	E6.290.060.12	70
E6.29.070 ▶	E6.290.070.12	80

For	Part No.	Dim. A
E-Chain®	full set	[mm]
E6.29.080 ▶	E6.290.080.12	90
E6.29.090 ▶	E6.290.090.12	100
E6.29.100 ▶	E6.290.100.12	110
E6.29.110 ▶	E6.290.110.12	120
E6.29.120 ▶	E6.290.120.12	130

Phone +49- (0) 22 03-96 49-800
Fax +49- (0) 22 03-96 49-222

igus® GmbH
51147 Cologne

Internet: www.igus.eu
E-mail: info@igus.de



Other strain relief elements - optional ▶ chapter 10

E6 | E-Chain® | Series E6.29 | Accessories | Strain Relief

igus® Chainfix tiwrap plate as individual part

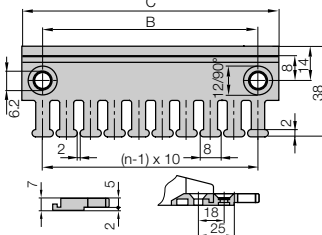

Tiewrap plate	n Number of teeth	Dim. C [mm]	Dim. B [mm]
2020.ZB	3	30	15
2030.ZB	4	40	20
2040.ZB	5	50	30
2050.ZB	6	60	40
2070.ZB	8	80	60
2090.ZB =			
(2030.ZB + 2040.ZB)	9	90	-
2100.ZB	10	100	80
2125.ZB =			
(2050.ZB + 2050.ZB)	12	120	-

Strain relief separator

Separator with integrated strain relief for the use in the first or last chain link. Individual part for the manufacturing of switchgear cabinets or for the assembly of machines. Easy to assemble without any screws ▶ chapter 10.

Part No.	Number of teeth	For Series
E6.29.02.Z	2 one side	E6.29 E-Chain®

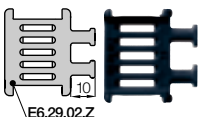

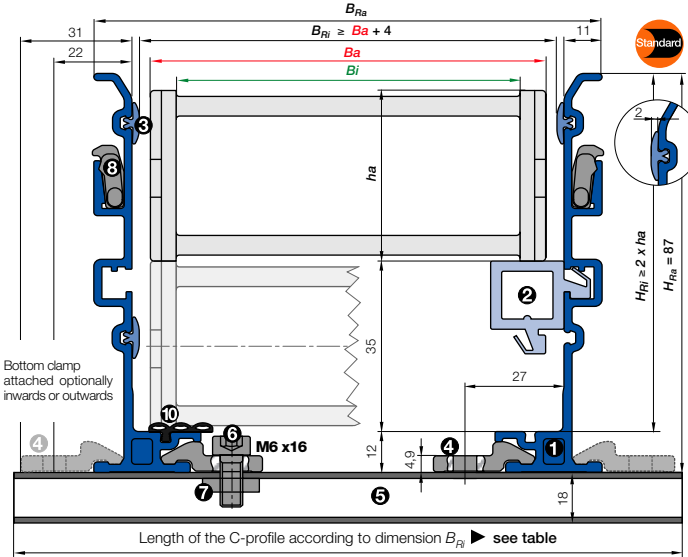

- B_a = Outer width E-Chains* / E-Tube
- B_i = Inner width E-Chains* / E-Tube
- h_a = Outer height E-Chains* / E-Tube
- H_{Ri} = Inner trough height
- H_{Ra} = Outer trough height
- B_{Ri} = Inner trough width ► depends on dim. B_a
- B_{Ra} = Outer trough width
- n_{Mon} = Number of installation sets (left/right)
- n_{Ri} = Number of trough sets (left/right)
- ! $H_{Ri} \geq 2 \cdot h_a$
- ! $B_{Ri} \geq B_a + 4$
- = Guide trough set ● = Glide bar
- = Installation set "Basic" ● = C-profile

Installation set "Basic" with C-profile

Bottom Clamp attached optionally inwards or outwards ►

E6.29.030.100.0 Order example

B_{Ri} [mm]	Part No.	
	attached inwards	attached outwards
.030	50	-
.040	60	-
.050	70	-
.060	80	960.30.150
.070	90	960.30.150
.080	100	960.30.150
.090	110	960.30.175
.100	120	960.30.175
.110	130	960.30.200
.120	140	960.30.200



- **Components, trough "Basic":** ① Trough side parts, aluminum, 2 m ② Glide bar, plastic, 2 m ③ Glide strips, plastic, 2 m (without glide strips on request) ⑩ Optional: Silencer profile, rubber
- **Components, installation set "Basic":** ④ Bottom clamp, aluminum ⑤ C-profile, steel galvanized ⑥ Screw M6 x16 ⑦ Sliding nut M6 ⑧ Interface connector, plastic



Order example: Length of travel 30 m - Center mounted for Series E6.29.060.100.0 with $B_{Ri} = 80$

- Guide trough set (set of 2 trough side parts, incl. glide strips) **without** glide bar
Order text: 16 m guide trough without glide bar (8 x 2 m sections) **Part No. 971.30.SL**
- Guide trough set (set of 2 trough side parts, incl. glide strips) **with** glide bar
Order text: 16 m guide trough with glide bar (8 x 2 m sections) **Part No. 971.31.SL**
- Installation set "Basic" complete (guide trough-sets + 1)
Order text: 17 installation sets "Basic" **Part No. 960.30.150**
- Option:** For an additional noise dampening with silencer profile, please add Index A - Example: **Part No. 971.30.SLA**

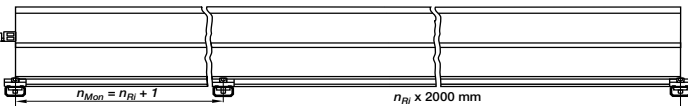

Principle sketch: Number of installation sets to be installed = **Number of trough sections + 1**

Insert for the installation set "Heavy-Duty": **971.50.XXX** instead of (960.30.XXX) on the right column "attached outwards"

Phone +49- (0) 22 03-96 49-800
 Fax +49- (0) 22 03-96 49-222



► chapter 10



► chapter 9



► page 8.39

● ● ● Price index



Extremely low noise
Test results upon request



IPA certificate: Class 1, according to standard DIN EN ISO 14644-1 for the E6 system (Series E6.29.060.150.0.CR, $v = 0.5 \text{ m/s}$, $a = 1.0 \text{ m/s}^2$)



LEVEL 1 absorption confirmed by IPA-Fraunhofer-Institut according to SEMI E78-0998 for the E6 standard material



When to use the Series R6.29:

- If a low-noise version is required
- At very high speeds and/or accelerations
- Protection against dirt and chips
- For small bending radii
- If less vibration is required
- Minimal abrasion
(e.g. cleanroom applications)



When not to use it:

- Limited in side-mounted applications
 - ▶ Series 2450/2480 E2/000, page 5.102
- No use with RBR (reverse bending radius)
 - ▶ Series 2450/2480 E2/000, page 5.102
- No use with high additional loads
 - ▶ Series 2450/2480 E2/000, page 5.102

- ① Fully enclosed E-Tube
- ② No pin and bore connection
- ③ Can be shortened or lengthened due to modular design
- ④ Very large gliding surfaces
- ⑤ Interior stop dog
- ⑥ Small pitch for low-noise, smooth operation
- ⑦ KMA mounting brackets with attachment points on all sides (strain relief with separate tie-wrap plates possible)
- ⑧ Enclosed design protects from light debris, weld splatter and compromising environmental influences

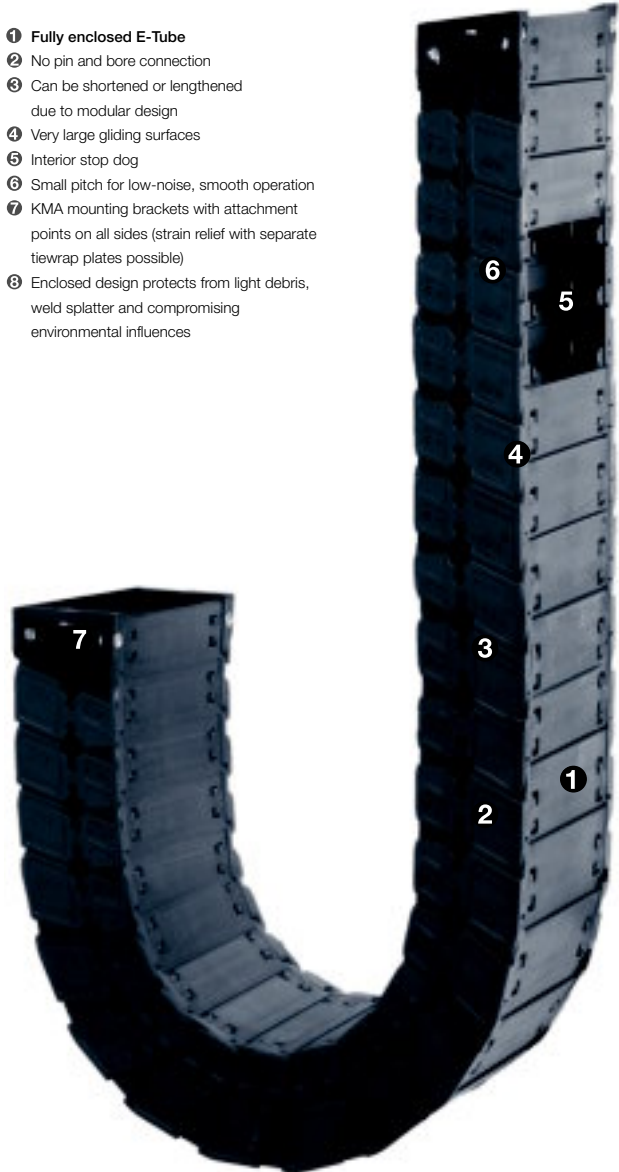

Order example complete E-Chain®

Please indicate chain-lengths or number of links **Example: 2 m or 92 links**

2 m **R6.29.080.100.0**

E-Tube

with 2 separators **R6.29.11** assembled every 2nd link

Interior separation

1 set **R6.290.080.12**

Mounting bracket



Unsupported length

FL_G = with straight upper run

FL_B = with permitted sag

Further information ► Design, page 1.12

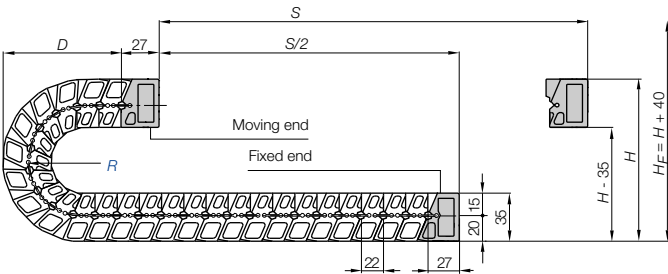
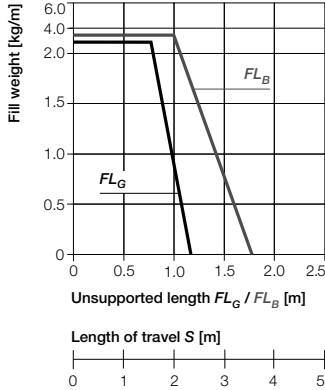
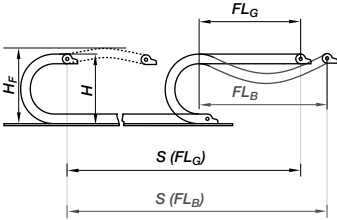

Pitch = 22 mm/link Links/m = 46 (1012 mm) Chain length = $S/2 + K$

R	055	075	100	150
H (min.)	150	190	240	340
D	97	117	142	192
K	220	280	360	520

- S = Length of travel
- R = Bending radius
- H = Nominal clearance height
- H_F = Required clearance height
- D = Overlength E-Chain® radius in final position
- K = $\pi \cdot R + \text{"safety"}$

Other installation methods

- Vertical, hanging ≤ 30 m
- Vertical, standing ≤ 2 m
- Side mounted, unsupported = possible to a limited extent
- Unsupported length of upper run = upon request



Short travels - unsupported

Unsupported E-Chains® feature positive camber over short travels. This must be accounted for when specifying the clearance height H_F . Please consult igus® if space is particularly restricted.

The required clearance height:
 $H_F = H + 40$ mm
 (with 2,0 kg/m fill weight)

Speed / acceleration FL_G	max. 20 [m/s] / max. 200 [m/s ²]
Speed / acceleration FL_B	max. 3 [m/s] / max. 6 [m/s ²]
Gliding speed / acceleration (maximum)	upon request
permitted temperature °C	-40° up to +70° C
Flammability class	VDE 0304 IIC UL94 HB

Technical Data

Details of material properties
 ► page 1.38



System E6
 Inner height: 28 mm

Phone +49- (0) 22 03-96 49-800
 Fax +49- (0) 22 03-96 49-222



Trough E6.29
 ► page 8.45



► page 8.39



For support of the lower run - **Support Tray tool kit** available ► page 9.70

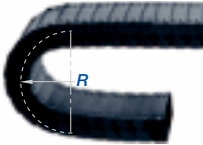
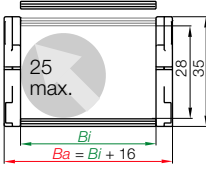

Series R6.29 - E-Tube, lids can be removed along inner and outer radius

Part No.	Bi [mm]	Ba [mm]	R [mm]	Bending radii			Weight [kg/m]
R6.29.030.	30	46	055	075	100	150	≈ 0,80
R6.29.040.	40	56	055	075	100	150	≈ 0,85
R6.29.050.	50	66	055	075	100	150	≈ 0,89
R6.29.060.	60	76	055	075	100	150	≈ 0,94
R6.29.070.	70	86	055	075	100	150	≈ 0,97
R6.29.080.	80	96	055	075	100	150	≈ 1,03
R6.29.090.	90	106	055	075	100	150	≈ 1,08
R6.29.100.	100	116	055	075	100	150	≈ 1,13
R6.29.110.	110	126	055	075	100	150	≈ 1,18
R6.29.120.	120	136	055	075	100	150	≈ 1,22

The widths Bi 040 / 070 / 090 are available upon request.

Time of delivery approx. 6-8 weeks after order.

Supplement Part No. with required radius. Example: R6.29.060.100.0

0 = standard color, other colors ▶ page 1.39 / Pitch = 22 mm/link - Links/m = 46

Part No. structure

R6.29.060.100.0

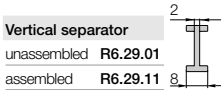

E6 | E-Tube | Series R6.29 | Accessories | Interior Separation

Option 1: Vertical separators

Vertical separators are used if a vertical subdivision of the E-Chain® interior is required - By standard vertical separators are assembled every other E-Chain® link!

- The notches on this separator marks the sticking side for a stuck mounting on the lid
- Standard subdivision with vertical separator E6.29.11

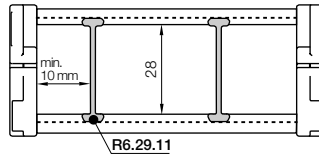
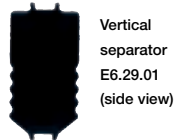



* KMA = Polymer Metal Mounting Bracket

Option KMA* - pivoting

- Bolted connection outside of chain cross-section
- Recommended for unsupported applications (for gliding applications please contact igus®)
- Confined installation conditions
- Universal mountable with attachment capability on all sides

Moving end
R6.290...2

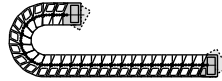

R6.290...1
Fixed end



The attachment variants arising automatically by the choice of the KMA mounting bracket

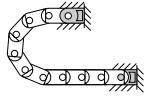

R6.290...2
Fixed end

R6.290...1
Moving end

Dimensions and order configurations

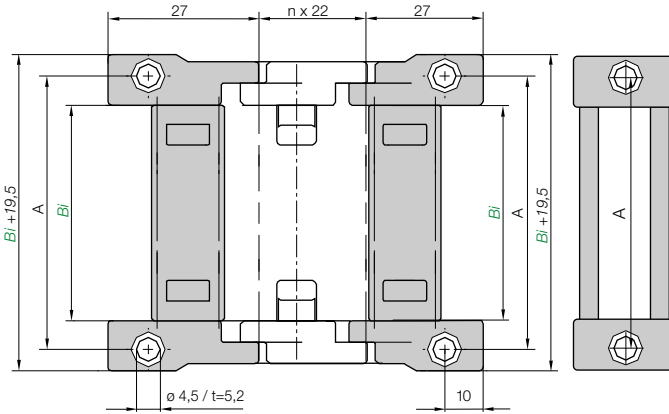

Part No. structure

R6.290.030.12



Full set, for both ends:

R6.290.030.12

Single-part order:

R6.290.030.1

Fixed end mounting bracket

R6.290.030.2

Moving end mounting bracket

For E-Chain®	Part No. full set	Dim. A [mm]
R6.29.030	R6.290.030.12	40
R6.29.050	R6.290.050.12	60
R6.29.060	R6.290.060.12	70
R6.29.080	R6.290.080.12	90

For E-Chain®	Part No. full set	Dim. A [mm]
R6.29.100	R6.290.100.12	110
R6.29.110	R6.290.110.12	120
R6.29.120	R6.290.120.12	130

E6 | E-Chain® | Series R6.29 | Accessories | Strain Relief

Tiewrap plate	n Number of teeth	Dim. C [mm]	Dim. B [mm]
2020.ZB	3	30	15
2030.ZB	4	40	20
2040.ZB	5	50	30
2050.ZB	6	60	40
2070.ZB	8	80	60
2090.ZB = (2030.ZB + 2040.ZB)	9	90	-
2100.ZB	10	100	80
2125.ZB = (2050.ZB + 2050.ZB)	12	120	-

igus® Chainfix tiewrap plate as individual part

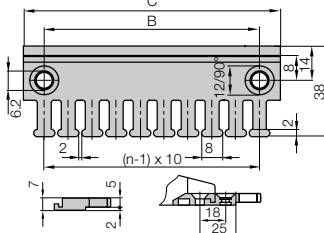

Other strain relief elements - optional ▶ chapter 10

Phone +49- (0) 22 03-96 49-800
Fax +49- (0) 22 03-96 49-222



▶ chapter 10



Trough E6.29 ▶ page 8.45



▶ page 8.39



Price index



Extremely low noise
Test results upon request



IPA certificate: Class 1, according to standard DIN EN ISO 14644-1 for the E6 system (Series E6.29.060.150.0.CR, $v = 0.5 \text{ m/s}$, $a = 1.0 \text{ m/s}^2$)



LEVEL 1 absorption confirmed by IPA-Fraunhofer-Institut according to SEMI E78-0998 for the E6 standard material



To close, push and click shut



When to use the Series E6.35:

- If a low-noise version is required
- At very high speeds and/or accelerations
- For enlarged thrusts and tensile forces
- For small bending radii
- If less vibration is required
- Minimal abrasion
(e.g. cleanroom applications)



When not to use it:

- Limited in side-mounted applications
 - ▶ Series E4.32 System E4.1, page 7.34
- No use with RBR (reverse bending radius)
 - ▶ Series E4.32 System E4.1, page 7.34
- No use with high additional loads
 - ▶ Series E4.32 System E4.1, page 7.34
- No use in dirty environments
 - ▶ Series E4.32 System E4.1, page 7.34
- If a fully enclosed E-Tube is required
 - ▶ Series R58 E2 Tubes, page 6.34

- ① No pin and bore connection, minimal abrasion
- ② Small pitch for low-noise, smooth operation
- ③ Very large gliding surfaces
- ④ Interior stop dog
- ⑤ KMA mounting brackets with attachment points on all sides (strain relief with separate tiewrap plates possible)
- ⑥ Can be shortened or lengthened due to modular design
- ⑦ Strain relief separator E6.35.02.Z for the use in the first or last chain link

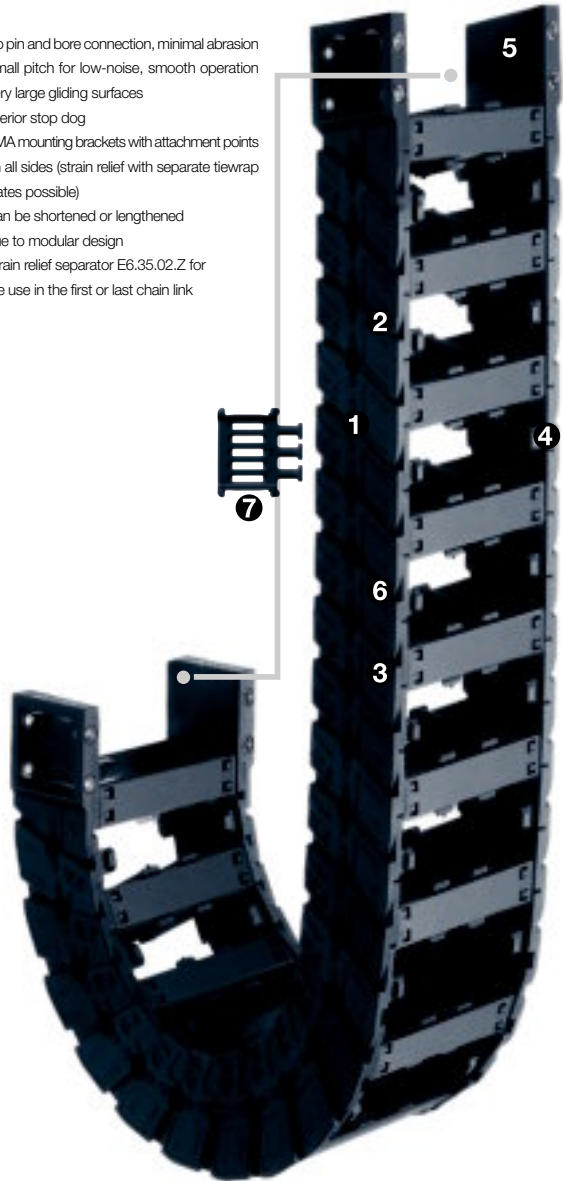

Order example complete E-Chain®

Please indicate chain-lengths or number of links **Example: 2 m or 80 links**

2 m **E6.35.100.055.0**



E-Chain®

with 2 separators **E6.35.01** assembled every 2nd link



Interior separation

1 set **E6.350.100.12**



Mounting bracket



Unsupported length

FL_G = with straight upper run

FL_B = with permitted sag

Further information ► **Design, page 1.12**

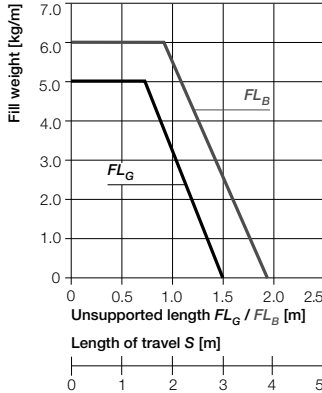
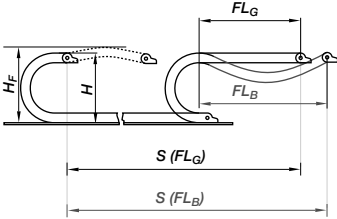

- S = Length of travel
- R = Bending radius
- H = Nominal clearance height
- H_F = Required clearance height
- D = Overlength E-Chain® radius in final position
- $K = \pi \cdot R + \text{"safety"}$

Other installation methods

- Vertical, hanging ≤ 30 m
- Vertical, standing ≤ 2 m
- Side mounted, unsupported = possible to a limited extent
- Unsupported length of upper run = upon request

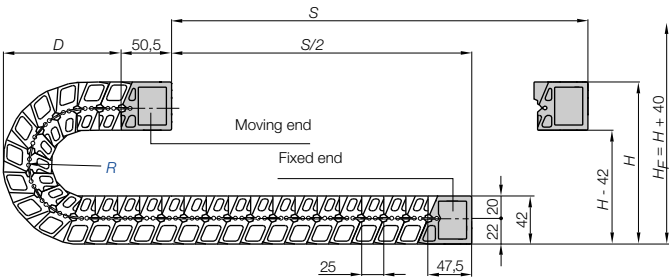

Pitch = 25 mm/link Links/m = 40 (1.000 mm) Chain length = $S/2 + K$

R	055	075*	100	125*	150*
H (min.)	154	194	244	294	344
D	102	122	147	172	197
K	225	290	365	445	525

*Available upon request. Delivery time: approx. 6-8 weeks after receipt of order!



Short travels - unsupported

Unsupported E-Chains® feature positive camber over short travels. This must be accounted for when specifying the clearance height H_F . Please consult igus® if space is particularly restricted.

The required clearance height:
 $H_F = H + 40$ mm
 (with 2,0 kg/m fill weight)

Technical Data

Speed / acceleration FL_G	max. 20 [m/s] / max. 200 [m/s ²]
Speed / acceleration FL_B	max. 3 [m/s] / max. 6 [m/s ²]
Gliding speed / acceleration (maximum)	upon request
Material - permitted temperature °C	-40° up to +70° C
Flammability class	VDE 0304 IIC UL94 HB



Details of material properties

► page 1.38

35

System E6
Inner height: 35 mm

Phone +49- (0) 22 03-96 49-800
Fax +49- (0) 22 03-96 49-222



► page 8.39

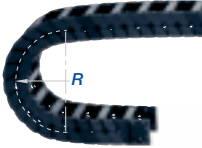
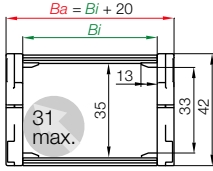

For support of the lower run - **Support Tray tool kit** available ► page 9.70

Series E6.35 - with crossbars every 2nd link

Part No.	B_i [mm]	B_a [mm]	R [mm]	Bending radii	Weight [kg/m]
E6.35.030.□.0	30	50	055	075 100 125 150	≈ 0,88
E6.35.040.□.0	40	60	055	075 100 125 150	≈ 0,90
E6.35.050.□.0	50	70	055	075 100 125 150	≈ 0,92
E6.35.060.□.0	60	80	055	075 100 125 150	≈ 0,94
E6.35.070.□.0	70	90	055	075 100 125 150	≈ 0,96
E6.35.080.□.0	80	100	055	075 100 125 150	≈ 0,99
E6.35.090.□.0	90	110	055	075 100 125 150	≈ 1,01
E6.35.100.□.0	100	120	055	075 100 125 150	≈ 1,03
E6.35.110.□.0	110	130	055	075 100 125 150	≈ 1,05
E6.35.120.□.0	120	140	055	075 100 125 150	≈ 1,07

The bending radii **075** **125** **150** are available upon request.

Delivery time: approx. 6-8 weeks after receipt of order!

Supplement Part No. with required radius. Example: E6.35.100.**055**.0

0 = standard color, other colors ▶ page 1.39 · Pitch = 25 mm/link - Links/m = 40

Part No. structure

E6.35.100.055.0



Phone +49- (0) 22 03-96 49-800
Fax +49- (0) 22 03-96 49-222

igus® GmbH
51147 Cologne

Internet: www.igus.eu
E-mail: info@igus.de

Part No. E-Chain® - links, single parts



Polymer spring as single part -
Part No. E6.35.150

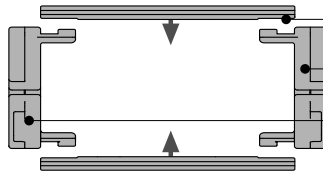

Single crossbar, Part No. 2105.Bi

Right side link*, single part, Part No. E6.35.02. **R**

Left side link*, single part, Part No. E6.35.01. **R**

*View from the fixed point

Option 1: Vertical separators

Vertical separators are used if a vertical subdivision of the E-Chain® interior is required -

By standard vertical separators are assembled every other E-Chain® link!

- **Standard** subdivision with **vertical separator E6.35.11**, for combinations with **full-width shelf 111.X**
- **Middle plate® E6.35.12** (slotted 5 times) for combinations with **side plate E6.35.13**, **full-width shelf 221.X** and **Shelf 2210.X**
- **Strain relief separator E6.35.12.Z** (slotted 5 times), can be integrated into the mounting bracket and can be placed there at any point

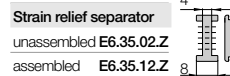
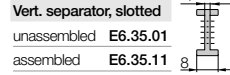
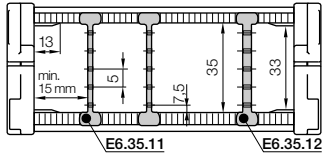

System E6
Inner height: 35 mm

Option 2: Full-width shelves

For applications involving many thin cables with similar or identical diameters

- **Full-width shelf 111.X** for combinations with **vertical separator E6.35.11**
- **Full-width shelf 221.X** for combinations with **middle plate E6.35.12**, **strain relief separator E6.35.12.Z**, and **side plate E6.35.13**

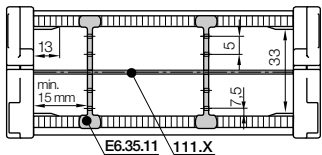

Width X [mm]	Part No. unassembled		Part No. assembled	
	110.X	220.X	111.X	221.X
030	110.30	220.30	111.30	221.30
040	110.40	220.40	111.40	221.40
050	110.50	220.50	111.50	221.50
060	110.60	220.60	111.60	221.60
070	110.70	220.70	111.70	221.70

Width X [mm]	Part No. unassembled		Part No. assembled	
	110.X	220.X	111.X	221.X
080	110.80	220.80	111.80	221.80
090	110.90	220.90	111.90	221.90
100	110.100	220.100	111.100	221.100
110	110.110	220.110	111.110	221.110
120	110.120	220.120	111.120	221.120

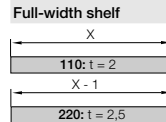

Option 3: Shelves

Shelves can be arranged elevator-shifted with different bottoms within the entire E-Chain® width

- **Shelf 2210.X** for combinations with **middle plate E6.35.12**, **strain relief separator E6.35.12.Z**, and **side plate E6.35.13**

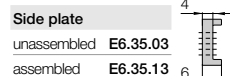
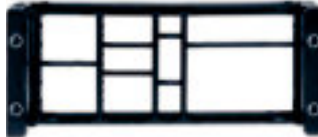
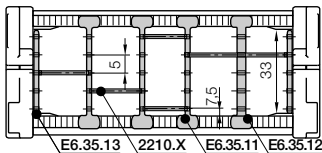

Width X [mm]	Part No.	Part No.
	unassembled	assembled
018	2200.18	2210.18
023	2200.23	2210.23
028	2200.28	2210.28
033	2200.33	2210.33
038	2200.38	2210.38
043	2200.43	2210.43

Width X [mm]	Part No.	Part No.
	unassembled	assembled
048	2200.48	2210.48
058	2200.58	2210.58
068	2200.68	2210.68
073	2200.73	2210.73
088	2200.88	2210.88
099	2200.99	2210.99

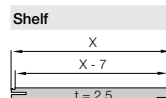

Phone +49- (0) 22 03-96 49-800
Fax +49- (0) 22 03-96 49-222

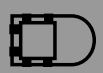

▶ page 8.39



The attachment variants arising automatically by the choice of the KMA mounting bracket

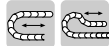
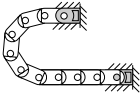

* KMA = Polymer Metal Mounting Bracket

Option KMA* - pivoting

- Option - integrated C-profile strain relief device with Chainfix clip or strain relief tiewrap plates
- C-profile mountable in the inner or outer radius of the E-Chain®
- Bolted connection outside of chain cross-section
- Recommended for unsupported and gliding applications
- Confined installation conditions
- Universal mountable with attachment capability on all sides

Moving end
E6.350...2

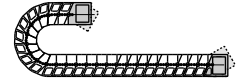

E6.350...1
Fixed end

Dimensions and order configurations

E6.350...2
Fixed end

E6.350...1
Moving end

Part No. structure

E6.350. 040. 12

Full set
Width
KMA pivoting for selected chain type

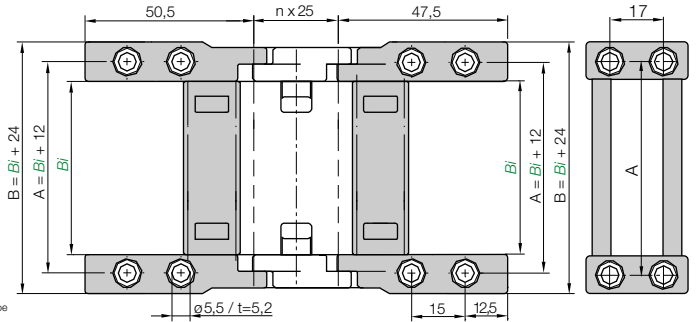

Full set, for both ends:

E6.350. 040. 12

Single-part order:

E6.350. 040. 1

Fixed end mounting bracket

E6.350. 040. 2

Moving end mounting bracket

For E-Chain®	Part No. full set	Dim. B [mm]	Dim. A [mm]
E6.35.030.	▶ E6.350.030.12	54	42
E6.35.040.	▶ E6.350.040.12	64	52
E6.35.050.	▶ E6.350.050.12	74	62
E6.35.060.	▶ E6.350.060.12	84	72
E6.35.070.	▶ E6.350.070.12	94	82

For E-Chain®	Part No. full set	Dim. B [mm]	Dim. A [mm]
E6.35.080.	▶ E6.350.080.12	104	92
E6.35.090.	▶ E6.350.090.12	114	102
E6.35.100.	▶ E6.350.100.12	124	112
E6.35.110.	▶ E6.350.110.12	134	122
E6.35.120.	▶ E6.350.120.12	144	132

Phone +49- (0) 22 03-96 49-800
Fax +49- (0) 22 03-96 49-222

igus® GmbH
51147 Cologne

Internet: www.igus.eu
E-mail: info@igus.de

E6 | E-Chain® | Series E6.35 | Accessories | Strain Relief

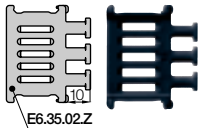

E6.35.02.Z

Strain relief separator

Separator with integrated strain relief for the use in the first or last chain link. Individual part for the manufacturing of switchgear cabinets or for the assembly of machines. Easy to assemble without any screws ▶ chapter 10.

Part No.	Number of teeth	For Series
E6.35.02.Z	3 one side	E6.35 E-Chain®



Other strain relief elements - optional ▶ chapter 10

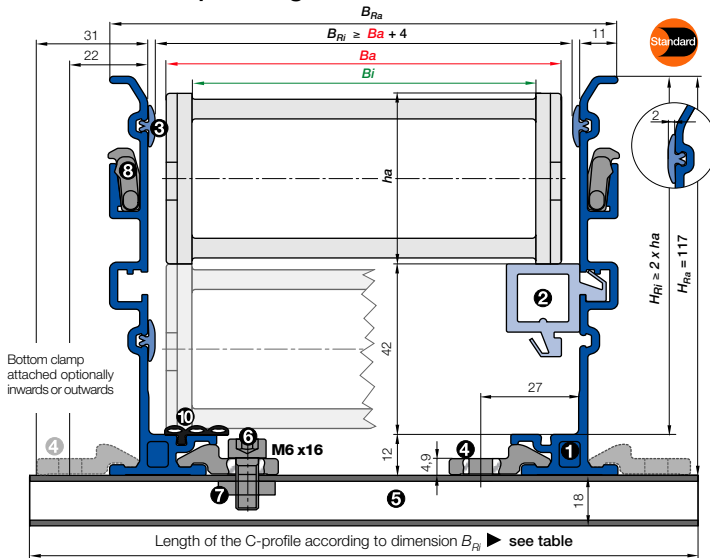

- B_a = Outer width E-Chains® / E-Tube
- B_i = Inner width E-Chains® / E-Tube
- h_a = Outer height E-Chains® / E-Tube
- H_{Ri} = Inner trough height
- H_{Ra} = Outer trough height
- B_{Ri} = Inner trough width ► depends on dim. B_a
- B_{Ra} = Outer trough width
- n_{Mon} = Number of installation sets (left/right)
- n_{Ri} = Number of trough sets (left/right)
- ! $H_{Ri} \geq 2 \cdot h_a$
- ! $B_{Ri} \geq B_a + 4$
- = Guide trough set ● = Glide bar
- = Installation set "Basic" ● = C-profile

Installation set "Basic" with C-profile

Bottom Clamp attached optionally inwards or outwards ►

E6.35.100.055.0 ► Order example

B_{Ri} [mm]	Part No.	
	attached inwards	attached outwards
.030	54	960.30.150
.040	64	960.30.175
.050	74	960.30.125 960.30.175
.060	84	960.30.150 960.30.200
.070	94	960.30.150 960.30.200
.080	104	960.30.150 960.30.200
.090	114	960.30.175 960.30.225
.100	124	960.30.175 960.30.225
.110	134	960.30.200 960.30.250
.120	144	960.30.200 960.30.250

Insert for the installation set "Heavy-Duty": **972.50.XXX** instead of (960.30.XXX) on the right column "attached outwards"



- **Components, trough "Basic":** ① Trough side parts, aluminum, 2 m ② Glide bar, plastic, 2 m ③ Glide strips, plastic, 2 m (without glide strips on request) ⑩ Optional: Silencer profile, rubber
- **Components, installation set "Basic":** ④ Bottom clamp, aluminum ⑤ C-profile, steel galvanized ⑥ Screw M6 x16 ⑦ Sliding nut M6 ⑧ Interface connector, plastic

Order example: Length of travel 30 m - Center mounted for Series E6.35.100.055.0 with $B_{Ri} = 124$

- Guide trough set (set of 2 trough side parts, incl. glide strips) **without** glide bar
- Order text: 16 m guide trough without glide bar (8 x 2 m sections) Part No. 972.02.30.SL**
- Guide trough set (set of 2 trough side parts, incl. glide strips) **with** glide bar
- Order text: 16 m guide trough with glide bar (8 x 2 m sections) Part No. 972.02.31.SL**
- Installation set "Basic" complete (guide trough-sets + 1)
- Order text: 17 installation sets "Basic" Part No. 960.30.175**
- Module for the fixed end
- Order text: 1 set Part No. 972.82**
- Option: For an additional noise dampening with silencer profile, please add Index A - Example: **Part No. 972.02.30.SLA**

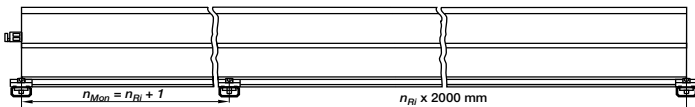

Principle sketch: Number of installation sets to be installed = Number of trough sections + 1



A quick fix for mounting the stationary end of an E-Chain®

With this module for the fixed end, fast and easy mounting onto the Aluminum "SuperTrough" is now possible without any drilling. Fast mounting of the E-Chain® by clamping onto the aluminum trough

- Quick relocation of the stationary end
- No drilling necessary ► page 9.16

Phone +49- (0) 22 03-96 49-800
Fax +49- (0) 22 03-96 49-222





Price index



Extremely low noise
Test results upon request



IPA certificate: Class 1, according to standard DIN EN ISO 14644-1 for the E6 system (Series E6.29.060.150.0.CR, $v = 0.5 \text{ m/s}$, $a = 1.0 \text{ m/s}^2$)



LEVEL 1 absorption confirmed by IPA-Fraunhofer-Institut according to SEMI E78-0998 for the E6 standard material



To close, push and click shut



When to use the Series E6.40:

- If a low-noise version is required
- At very high speeds and/or accelerations
- For enlarged thrusts and tensile forces
- For small bending radii
- If less vibration is required
- Minimal abrasion
(e.g. cleanroom applications)



When not to use it:

- Limited in side-mounted applications
 - ▶ Series E4.32 System E4.1, page 7.34
- No use with RBR (reverse bending radius)
 - ▶ Series E4.32 System E4.1, page 7.34
- No use with high additional loads
 - ▶ Series E4.32 System E4.1, page 7.34
- No use in dirty environments
 - ▶ Series E4.32 System E4.1, page 7.34

- ① No pin and bore connection
- ② Small pitch for low-noise, smooth operation
- ③ Very large gliding surfaces
- ④ Interior stop dog
- ⑤ KMA mounting brackets with attachment points on all sides (strain relief with separate tie-wrap plates possible)
- ⑥ Can be shortened or lengthened due to modular design
- ⑦ Optional with or without integrated C-profile
- ⑧ Strain relief separator E6.40.02.Z for the use in the first or last chain link
- ⑨ Series R6.40 - E-Tube-version available ▶ page 8.62

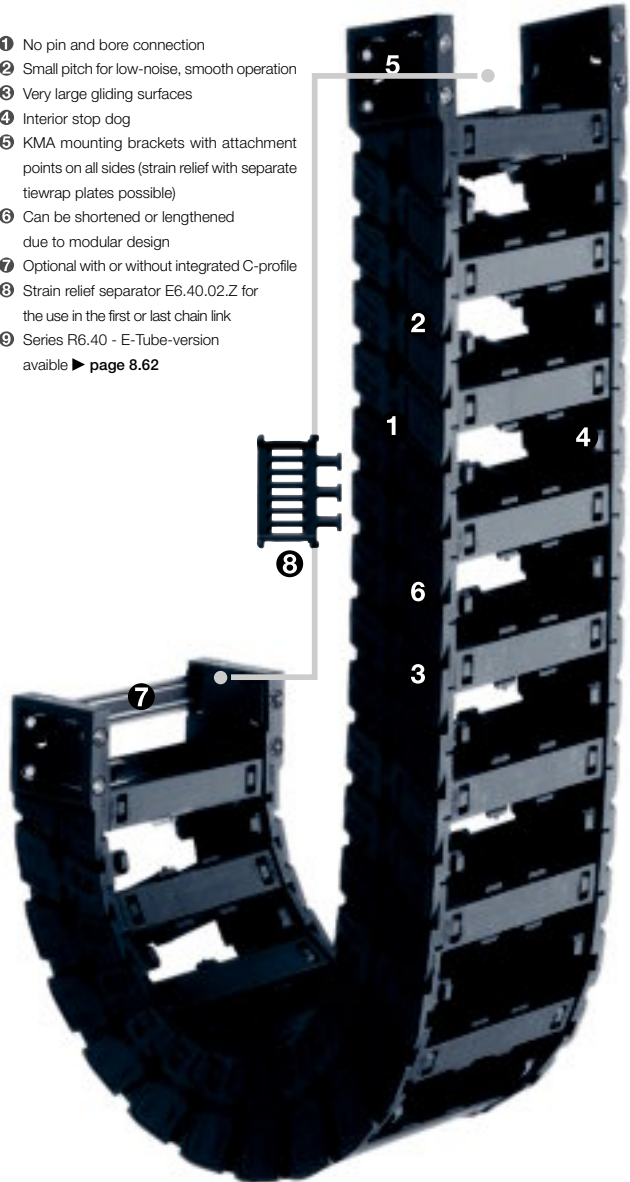

Order example complete E-Chain®

Please indicate chain-lengths or number of links **Example: 2 m or 72 links**

2 m **E6.40.100.075.0**

E-Chain®

with 2 separators **28222** assembled every 2nd link

Interior separation

1 set **E6.400.100.12**

Mounting bracket



Unsupported length

FL_G = with straight upper run

FL_B = with permitted sag

Further information ► **Design, page 1.12**

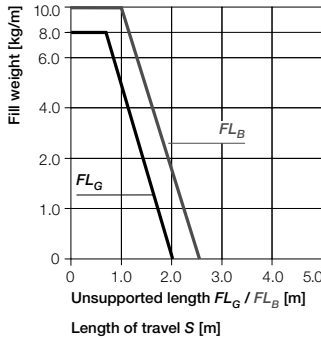
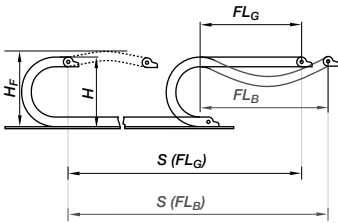

- S = Length of travel
 - R = Bending radius
 - H = Nominal clearance height
 - H_F = Required clearance height
 - H_{RI} = Trough inner height
 - D = Overlength E-Chain® radius in final position
 - $K = \pi \cdot R + \text{"safety"}$
 - D_2 = Over length - long travels, gliding
 - K_2 = "Further add-on"
 - H_2 = "Mounting height"
- *if the mounting bracket location is set lower

Other installation methods

- Vertical, hanging ≤ 30 m
- Vertical, standing ≤ 2 m
- Side mounted, unsupported = possible to a limited extent
- Unsupported length of upper run = upon request



Short travels - unsupported

Unsupported E-Chains® feature positive camber over short travels. This must be accounted for when specifying the clearance height H_F . Please consult igus® if space is particularly restricted.

The required clearance height:
 $H_F = H + 40$ mm
 (with 2,0 kg/m fill weight)

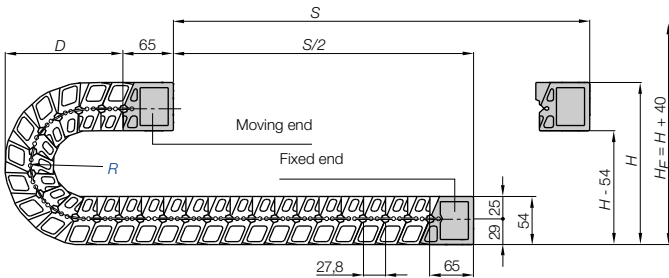

Pitch = 27,8 mm/link Links/m = 36 (1001 mm) Chain length = $S/2 + K$

R	063	075	100	125	150	200
H (min.)	184	208	258	308	358	458
D	120	132	157	182	207	257
K	255	295	370	450	530	685
H ₂	140	140	140	140	140	140
D ₂ ⁺²⁵	214	263	388	574	760	1382
K ₂	112	306	743	723	973	1474

Long travel lengths from 6 m to max. 60 m Chain length = $S/2 + K_2$

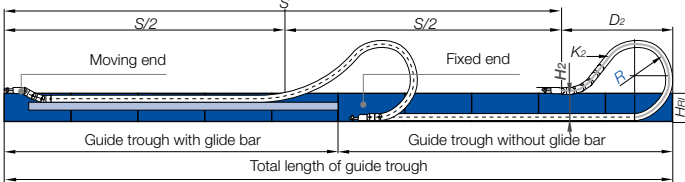

In case of travels between 4 m and 6 m we recommend a longer unsupported length.



Gliding, long travel applications (max. 60 m)

In this case the E-Chain® upper run will be introduced in a guide trough on the lower run. We recommend to realize the engineering of such a plant by our technicians.

Technical Data

Speed / acceleration FL_G	max. 20 [m/s] / max. 200 [m/s ²]
Speed / acceleration FL_B	max. 3 [m/s] / max. 6 [m/s ²]
Gliding speed / acceleration (maximum)	upon request
permitted temperature °C	-40° up to +70° C
Flammability class	VDE 0304 IIC UL94 HB



Details of material properties
 ► page 1.38

For support of the lower run - **Support Tray tool kit** available ► page 9.70

System E6
 Inner height: 40 mm

Phone +49- (0) 22 03-96 49-800
 Fax +49- (0) 22 03-96 49-222



► page 8.39

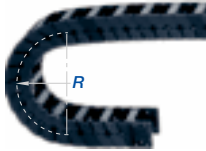
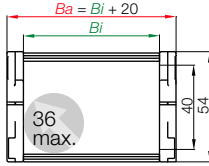

Part No. structure

E6.40.100.100.0

Series E6.40 - with crossbars every 2nd link

Part No.	B_i [mm]	B_a [mm]	R [mm]	Bending radii					Weight [kg/m]
E6.40.040.□.0	40	60	063	075	100	125	150	200	≈ 1,29
E6.40.050.□.0	50	70	063	075	100	125	150	200	≈ 1,33
E6.40.062.□.0	62	82	063	075	100	125	150	200	≈ 1,38
E6.40.070.□.0	70	90	063	075	100	125	150	200	≈ 1,41
E6.40.075.□.0	75	95	063	075	100	125	150	200	≈ 1,43
E6.40.087.□.0	87	107	063	075	100	125	150	200	≈ 1,48
E6.40.100.□.0	100	120	063	075	100	125	150	200	≈ 1,53
E6.40.125.□.0	125	145	063	075	100	125	150	200	≈ 1,63
E6.40.150.□.0	150	170	063	075	100	125	150	200	≈ 1,73
E6.40.175.□.0	175	195	063	075	100	125	150	200	≈ 1,83
E6.40.200.□.0	200	220	063	075	100	125	150	200	≈ 1,93
E6.40.225.□.0	225	245	063	075	100	125	150	200	≈ 2,02
E6.40.250.□.0	250	270	063	075	100	125	150	200	≈ 2,12
E6.40.275.□.0	275	295	063	075	100	125	150	200	≈ 2,22
E6.40.300.□.0	300	320	063	075	100	125	150	200	≈ 2,32

Supplement Part No. with required radius. Example: E6.40.100.□.0

0 = standard color, other colors ► page 1.39 · Pitch = 27,8 mm/link - Links/m = 36

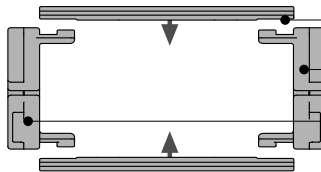

Part No. E-Chain® - links, single parts

Polymer spring as single part -
Part No. E6.40.177

Single crossbar, Part No. 225.Bi

Right side link*, single part, Part No. E6.40.02. R

Left side link*, single part, Part No. E6.40.01. R

*View from the fixed point

Option 1: Vertical separators

Vertical separators are used if a vertical subdivision of the E-Chain® interior is required -

By standard vertical separators are assembled every other E-Chain® link

- **Standard subdivision with vertical separator, slotted 28222 -**
for combinations with **full-width shelf 221.X**
- **Locking vertical separator E6.40.12, (slotted, 7 times) -** for combinations with **shelf 2210.X**
- **Strain relief separator E6.40.12.Z** (slotted 7 times), can be integrated into the mounting bracket and can be placed there at any point

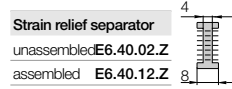
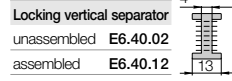
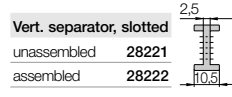
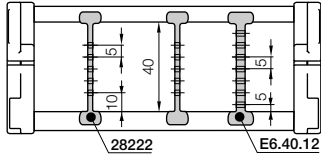

System E6
Inner height: 40 mm

Option 2: Full-width shelves

For applications involving many thin cables with similar or identical diameters

- **Full-width shelf 221.X** for combinations with
Vertical separator, slotted 28222 and Side plate E6.40.13 und Asymmetrical separator E6.40.18

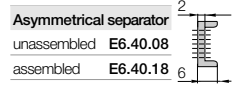
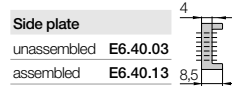
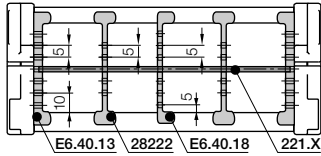

Width X [mm]	Part No. unassembled	Part No. assembled
040	220.40	221.40
050	220.50	221.50
062	220.62	221.62
070	220.70	221.70
075	220.75	221.75
087	220.87	221.87

Width X [mm]	Part No. unassembled	Part No. assembled
100	220.100	221.100
125	220.125	221.125
150	220.150	221.150
175	220.175	221.175
200	220.200	221.200

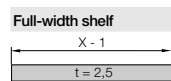

Option 3: Shelves

Shelves can be arranged elevator-shifted with different bottoms within the entire E-Chain® width

- **Shelf 2210.X** for combinations with **Locking vertical separator E6.40.12, and side plate E6.40.13**

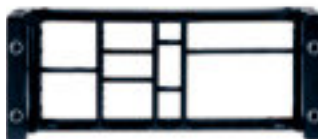
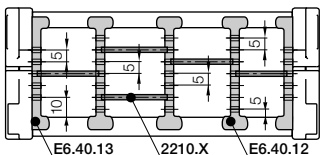

Width X [mm]	Part No. unassembled	Part No. assembled
018	2200.18	2210.18
023	2200.23	2210.23
028	2200.28	2210.28
033	2200.33	2210.33
038	2200.38	2210.38
043	2200.43	2210.43

Width X [mm]	Part No. unassembled	Part No. assembled
048	2200.48	2210.48
058	2200.58	2210.58
068	2200.68	2210.68
073	2200.73	2210.73
088	2200.88	2210.88
099	2200.99	2210.99

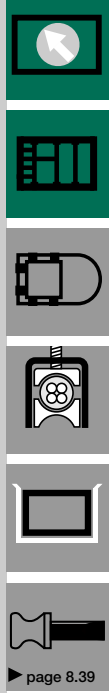
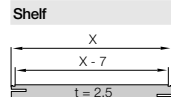

Phone +49- (0) 22 03-96 49-800
Fax +49- (0) 22 03-96 49-222



The attachment variants arising automatically by the choice of the KMA mounting bracket

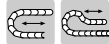
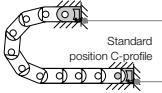

* KMA = Polymer Metal Mounting Bracket

Option KMA* - pivoting

- Option - integrated C-profile strain relief device with Chainfix clip or strain relief tiewrap plates
- C-profile mountable in the inner or outer radius of the E-Chain®
- Bolted connection outside of chain cross-section
- Recommended for unsupported and gliding applications
- Confined installation conditions
- Universal mountable with attachment capability on all sides

Moving end
E6.400...2

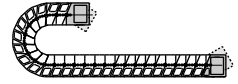

E6.400...1
Fixed end

Dimensions and order configurations



Adapters for gliding applications available upon request

Part No. structure

E6.400.040.12.C

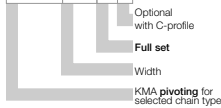

Full set, for both ends:

[E6.400.040.12](#)

Single-part order:

[E6.400.040.1](#)

Fixed end mounting bracket

[E6.400.040.2](#)

Moving end mounting bracket

E6.400...2
Fixed end

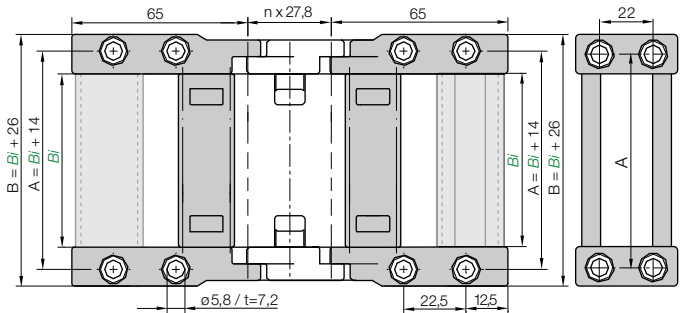

E6.400...1
Moving end

For E-Chain®	Part No. full set optional with C-profile	Dim. A [mm]	Dim. B [mm]
E6.40.040.	E6.400.040.12.C	54	66
E6.40.050.	E6.400.050.12.C	64	76
E6.40.062.	E6.400.062.12.C	76	88
E6.40.070.	E6.400.070.12.C	84	96
E6.40.075.	E6.400.075.12.C	89	101
E6.40.087.	E6.400.087.12.C	101	113
E6.40.100.	E6.400.100.12.C	114	126
E6.40.125.	E6.400.125.12.C	139	151

For E-Chain®	Part No. full set optional with C-profile	Dim. A [mm]	Dim. B [mm]
E6.40.150.	E6.400.150.12.C	164	176
E6.40.175.	E6.400.175.12.C	189	201
E6.40.200.	E6.400.200.12.C	214	226
E6.40.225.	E6.400.225.12.C	239	251
E6.40.250.	E6.400.250.12.C	264	276
E6.40.275.	E6.400.275.12.C	289	301
E6.40.300.	E6.400.300.12.C	314	326

Phone +49- (0) 22 03-96 49-800
Fax +49- (0) 22 03-96 49-222

igus® GmbH
51147 Cologne

Internet: www.igus.eu
E-mail: info@igus.de



Other strain relief elements - optional ► [chapter 10](#)

E6 | E-Chain® | Series E6.40 | Accessories | Strain Relief

Strain relief tiewrap plate can be fixed on the last crossbar, alternatively with C-profile. Tiewrap plate as individual part - [Part No. 20XX.ZB](#). Further strain relief elements ► [chapter 10](#)

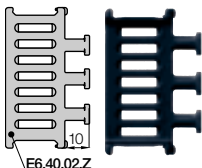

Strain relief separator

Separator with integrated strain relief for the use in the first or last chain link. Individual part for the manufacturing of switchgear cabinets or for the assembly of machines. Easy to assemble without any screws ► [chapter 10](#).

Part No.	Number of teeth	For Series
E6.40.02.Z	3 one side	E6.40 E-Chain®

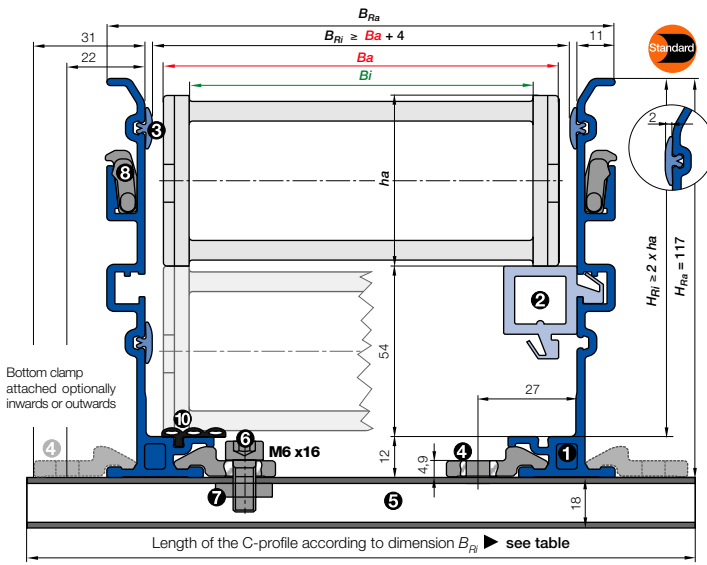

- Ba = Outer width E-Chains / E-Tube
- Bi = Inner width E-Chains / E-Tube
- ha = Outer height E-Chains / E-Tube
- H_{ri} = Inner trough height
- H_{ra} = Outer trough height
- B_{ri} = Inner trough width ▶ depends on dim. Ba
- B_{ra} = Outer trough width
- n_{Mon} = Number of installation sets (left/right)
- n_{ri} = Number of trough sets (left/right)
- $H_{ri} \geq 2 \cdot ha$
 $B_{ri} \geq Ba + 4$
- = Guide trough set ● = Glide bar
- = Installation set "Basic" ● = C-profile

Installation set "Basic" with C-profile

Bottom Clamp attached optionally inwards or outwards ▶

E6.40.040.063.0 ▶ Order example

B_{ri} [mm]	Part No.	
	attached inwards	attached outwards
.040 64	-	960.30.175
.050 74	960.30.125	960.30.175
.062 86	960.30.150	960.30.200
.070 94	960.30.150	960.30.200
.075 99	960.30.150	960.30.200
.087 111	960.30.175	960.30.225
.100 124	960.30.175	960.30.225
.125 149	960.30.200	960.30.250
.150 174	960.30.225	960.30.275
.175 199	960.30.250	960.30.300
.200 224	960.30.275	960.30.325
.225 249	960.30.300	960.30.350
.250 274	960.30.325	960.30.375
.275 299	960.30.350	960.30.400
.300 324	960.30.375	960.30.425



- **Components, trough "Basic":** ① Trough side parts, aluminum, 2 m ② Glide bar, plastic, 2 m ③ Glide strips, plastic, 2 m (without glide strips on request) ⑩ Optional: Silencer profile, rubber
- **Components, installation set "Basic":** ④ Bottom clamp, aluminum ⑤ C-profile, steel galvanized ⑥ Screw M6 x16 ⑦ Sliding nut M6 ⑧ Interface connector, plastic



Order example: Length of travel 30 m - Center mounted for Series E6.40.050.063.0 with $B_{ri} = 74$

- Guide trough set (set of 2 trough side parts, incl. glide strips) **without** glide bar
Order text: 16 m guide trough without glide bar (8 x 2 m sections) Part No. 972.30.SL
- Guide trough set (set of 2 trough side parts, incl. glide strips) **with** glide bar
Order text: 16 m guide trough with glide bar (8 x 2 m sections) Part No. 972.31.SL
- Installation set "Basic" complete (guide trough-sets + 1)
Order text: 17 installation sets "Basic" Part No. 960.30.125
- Module for the fixed end
Order text: 1 set Part No. 972.80
- Option: For an additional noise dampening with silencer profile, please add Index A - Example:
 Part No. 972.30.SLA

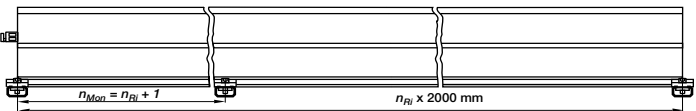

Principle sketch: Number of installation sets to be installed = **Number of trough sections + 1**

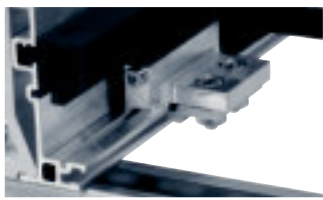

A quick fix for mounting the stationary end of an E-Chain®
 With this module for the fixed end, fast and easy mounting onto the Aluminum "SuperTrough" is now possible without any drilling. Fast mounting of the E-Chain® by clamping onto the aluminum trough
 ● Quick relocation of the stationary end ● No drilling necessary ▶ page 9.16

Insert for the installation set "Heavy-Duty": **972.50.XXX** instead of **960.30.XXX** on the right column "attached outwards"

Phone +49- (0) 22 03-96 49-800
 Fax +49- (0) 22 03-96 49-222

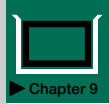
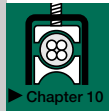
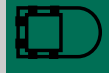

● ● ● Price index



Extremely low noise
Test results upon request



IPA certificate: Class 1, according to standard DIN EN ISO 14644-1 for the E6 system (Series E6.29.060.150.0.CR, $v = 0.5 \text{ m/s}$, $a = 1.0 \text{ m/s}^2$)



LEVEL 1 absorption confirmed by IPA-Fraunhofer-Institut according to SEMI E78-0998 for the E6 standard material



Deckel entfernen durch aufhebeln



When to use the Series R6.40:

- If a low-noise version is required
- At very high speeds and/or accelerations
- For enlarged thrusts and tensile forces
- For small bending radii
- If less vibration is required
- Minimal abrasion
(e.g. cleanroom applications)



When not to use it:

- Limited in side-mounted applications
▶ Series R4.32 System E4.1, page 7.34

- 1 Fully enclosed E-Tube
- 2 No pin and bore connection, minimal abrasion
- 3 Can be shortened or lengthened due to modular design
- 4 Very large gliding surfaces
- 5 Interior stop dog
- 6 Small pitch for low-noise, smooth operation
- 7 KMA mounting brackets with attachment points on all sides (strain relief with separate tiewrap plates possible)



Order example complete E-Chain®

Please indicate chain-lengths or number of links Example: 2 m or 72 links

2 m R6.40.062.075.0



E-Chain®

with 2 separators R6.40.11 assembled every 2nd link



Interior separation

1 set R6.400.062.12



Mounting bracket



Unsupported length

FL_G = with straight upper run

FL_B = with permitted sag

Further information ► **Design, page 1.12**

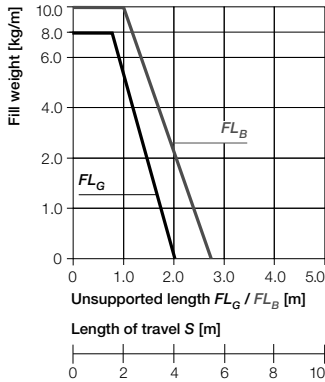
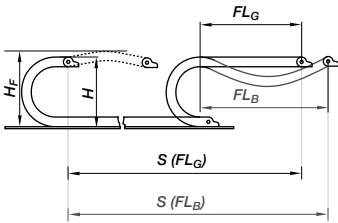

- S = Length of travel
 - R = Bending radius
 - H = Nominal clearance height
 - H_F = Required clearance height
 - H_{RI} = Trough inner height
 - D = Overlength E-Chain® radius in final position
 - $K = \pi \cdot R + \text{"safety"}$
 - D_2 = Over length - long travels, gliding
 - K_2 = "Further add-on"
 - H_2 = "Mounting height"
- *if the mounting bracket location is set lower

Other installation methods

- Vertical, hanging ≤ 30 m
- Vertical, standing ≤ 2 m
- Side mounted, unsupported
- = possible to a limited extent
- Unsupported length of upper run = upon request



Short travels - unsupported

Unsupported E-Chains® feature positive camber over short travels. This must be accounted for when specifying the clearance height H_F . Please consult igus® if space is particularly restricted.

The required clearance height:
 $H_F = H + 40$ mm
 (with 2,0 kg/m fill weight)

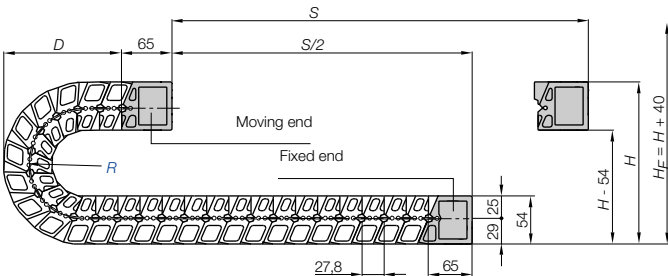

Pitch = 27,8 mm/link Links/m = 36 (1.000,8 mm) Chain length = $S/2 + K$

R	063	075	100	125	150	200
H (min.)	184	208	258	308	358	458
D	120	132	157	182	207	257
K	255	295	343	423	530	685
H ₂	140	140	140	140	140	140
D ₂ +25	214	263	388	574	760	1382
K ₂	112	306	743	723	973	1474

If you intend to use this series on long travels, we request you to consult us!

Long travel lengths from 6 m to max. 60 m Chain length = $S/2 + K_2$

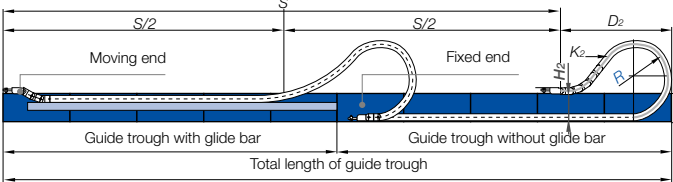

Gliding, long travel applications (max. 60 m)

In this case the E-Chain® upper run will be introduced in a guide trough on the lower run. We recommend to realize the engineering of such a plant by our technicians.

In case of travels between 4 m and 6 m we recommend a longer unsupported length.

Technical Data

Speed / acceleration FL_G	max. 20 [m/s] / max. 200 [m/s ²]
Speed / acceleration FL_B	max. 3 [m/s] / max. 6 [m/s ²]
Gliding speed / acceleration (maximum)	upon request
Material - permitted temperature °C	-40° up to +70° C
Flammability class	VDE 0304 IIC UL94 HB



Details of material properties
 ► page 1.38



For support of the lower run - **Support Tray tool kit** available ► page 9.70



System E6
 Inner height: 40 mm

Phone +49- (0) 22 03-96 49-800
 Fax +49- (0) 22 03-96 49-222



Trough E6.40
 ► page 8.61



► page 8.39

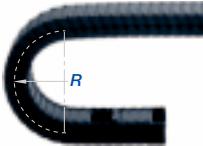
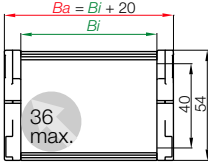

Part No. structure

R6.40.062.100.0



Series R6.40 - E-Tube, lids can be removed along inner and outer radius

Part No.	Bi [mm]	Ba [mm]	R [mm]	Bending radii					Weight [kg/m]
R6.40.062.□.0	62	82	063	075	100	125	150	200	~ 1,44
R6.40.075.□.0	75	95	063	075	100	125	150	200	-
R6.40.087.□.0	87	107	063	075	100	125	150	200	-
R6.40.100.□.0	100	120	063	075	100	125	150	200	-
R6.40.125.□.0	125	145	063	075	100	125	150	200	-
R6.40.150.□.0	150	170	063	075	100	125	150	200	-
R6.40.175.□.0	175	195	063	075	100	125	150	200	-
R6.40.200.□.0	200	220	063	075	100	125	150	200	-
R6.40.225.□.0	225	245	063	075	100	125	150	200	-
R6.40.275.□.0	275	295	063	075	100	125	150	200	-
R6.40.300.□.0	300	320	063	075	100	125	150	200	-

The widths 075 / 087 / 100 / 125 / 150 / 175 / 200 / 225 / 275 / 300 are available upon request.

Time of delivery approx. 6-8 weeks after order.

Supplement Part No. with required radius. Example: R6.40.062.100.0

0 = standard color, other colors ► page 1.39 - Pitch = 27,8 mm/link - Links/m = 36



Vertical separator

unassembled R6.40.01
assembled R6.40.11



E6 | E-Tube | Series R6.40 | Accessories | Interior Separation

Option 1: Vertical separators

Vertical separators are used if a vertical subdivision of the E-Chain® interior is required - By standard vertical separators are assembled every other E-Chain® link!

- The notches on this separator marks the sticking side for a stuck mounting on the lid
- Standard subdivision with vertical separator R6.40.11



Vertical separator
R6.40.01
(side view)

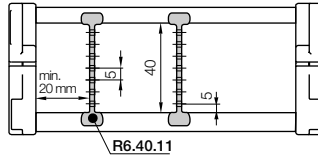

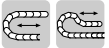

* KMA = Polymer Metal Mounting Bracket

Option KMA* - pivoting

- Option - integrated C-profile strain relief device with Chainfix clip or strain relief tiwrap plates
- C-profile mountable in the inner or outer radius of the E-Chain*
- Bolted connection outside of chain cross-section
- Recommended for unsupported and gliding applications
- Confined installation conditions
- Universal mountable with attachment capability on all sides

Moving end
R6.400...2

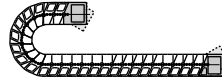

The attachment variants arising automatically by the choice of the KMA mounting bracket

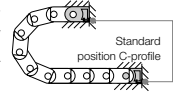

R6.400...1
Fixed end

R6.400...2
Fixed end

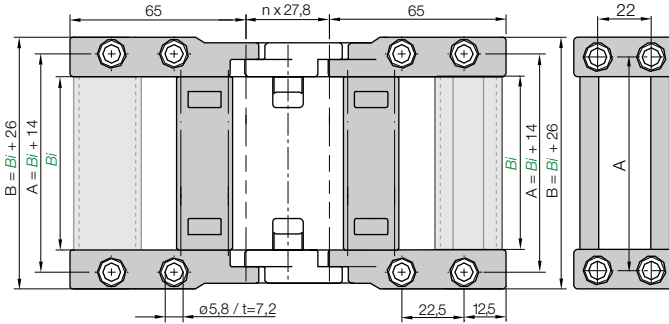

R6.400...1
Moving end

Dimensions and order configurations

Part No. structure

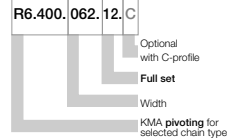

For E-Chain*	Part No. full set optional with C-profile	Dim. A [mm]	Dim. B [mm]
R6.40.062.	R6.400.062.12.C	76	88
R6.40.075.	R6.400.075.12.C	89	101
R6.40.087.	R6.400.087.12.C	101	113
R6.40.100.	R6.400.100.12.C	114	126
R6.40.125.	R6.400.125.12.C	139	151
R6.40.150.	R6.400.150.12.C	164	176

For E-Chain*	Part No. full set optional with C-profile	Dim. A [mm]	Dim. B [mm]
R6.40.175.	R6.400.175.12.C	189	201
R6.40.200.	R6.400.200.12.C	214	226
R6.40.225.	R6.400.225.12.C	239	251
R6.40.275.	R6.400.275.12.C	289	301
R6.40.300.	R6.400.300.12.C	314	326

Full set, for both ends:

R6.400.062.12

Single-part order:

R6.400.062.1

Fixed end mounting bracket

R6.400.062.2

Moving end mounting bracket

E6 | E-Tube | Series R6.40 | Accessories | Strain Relief

Strain relief tiwrap plate can be fixed on the last crossbar, alternatively with C-profile. Tiwrap plate as individual part - Part No. 30XX.ZB. Further strain relief elements ▶ chapter 10



Other strain relief elements - optional ▶ chapter 10



Trough E6.40
▶ page 8.61



▶ page 8.39



Price index



Extremely low noise
Test results upon request



IPA certificate: Class 1, according to standard DIN EN ISO 14644-1 for the E6 system (Series E6.29.060.150.0.CR, $v = 0.5 \text{ m/s}$, $a = 1.0 \text{ m/s}^2$)



LEVEL 1 absorption confirmed by IPA-Fraunhofer-Institut according to SEMI E78-0998 for the E6 standard material



To close, push and click shut



When to use the Series E6.52:

- If a low-noise version is required
- At very high speeds and/or accelerations
- For enlarged thrusts and tensile forces
- For small bending radii
- If less vibration is required
- Minimal abrasion
(e.g. cleanroom applications)



When not to use it:

- Limited in side-mounted applications
▶ Series E4.42 System E4.1, page 7.48
- No use with RBR (reverse bending radius)
▶ Series E4.42 System E4.1, page 7.48
- No use with high additional loads
▶ Series E4.42 System E4.1, page 7.48
- No use in dirty environments
▶ Series E4.42 System E4.1, page 7.48

- ① No pin and bore connection
- ② Interior stop dog
- ③ Very large gliding surfaces
- ④ Small pitch for low-noise, smooth operation
- ⑤ Can be shortened or lengthened due to modular design
- ⑥ KMA mounting brackets with attachment points on all sides (strain relief with separate tie-wrap plates possible)
- ⑦ Optional with or without integrated C-profile
- ⑧ Series R6.52 - E-Tube-version available ▶ page 8.72

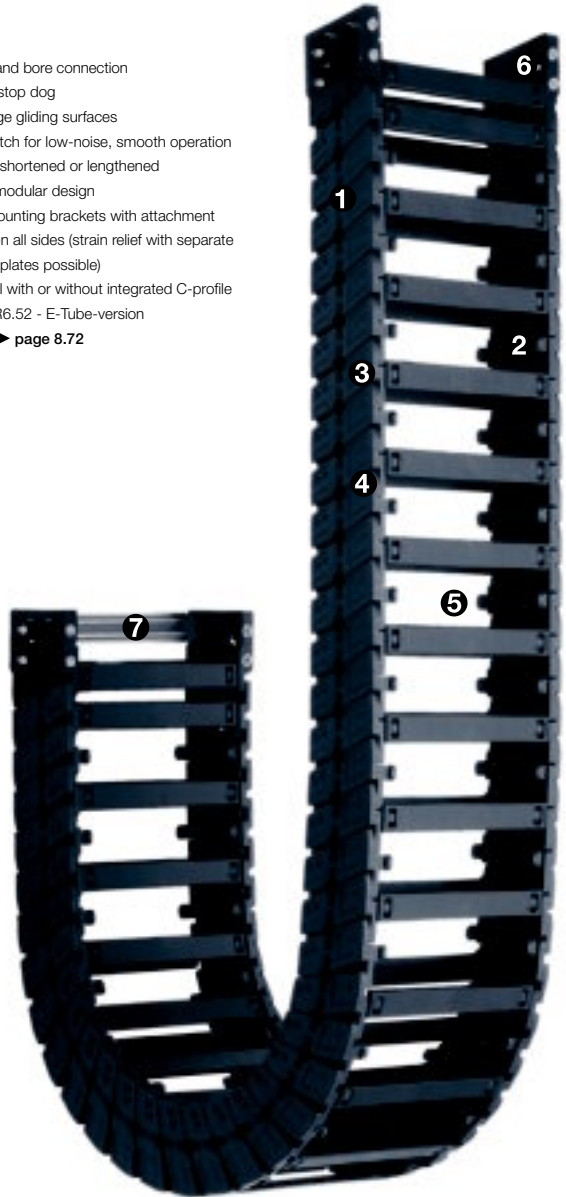

Order example complete E-Chain®

Please indicate chain-lengths or number of links Example: 2 m or 68 links

2 m E6.52.100.075.0

E-Chain®

with 2 separators 38222 assembled every 2nd link

Interior separation

1 set E6.520.100.12

Mounting bracket



Unsupported length

FL_G = with straight upper run

FL_B = with permitted sag

Further information ► **Design, page 1.12**

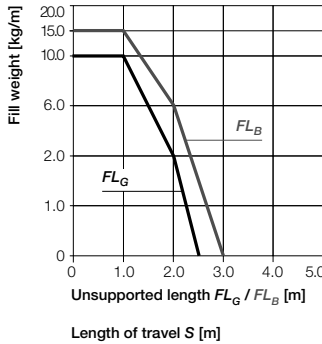
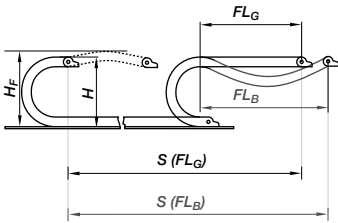

- S = Length of travel
 - R = Bending radius
 - H = Nominal clearance height
 - H_F = Required clearance height
 - H_{RI} = Trough inner height
 - D = Overlength E-Chain® radius in final position
 - $K = \pi \cdot R + \text{"safety"}$
 - D_2 = Over length - long travels, gliding
 - K_2 = "Further add-on"
 - H_2 = "Mounting height"
- *if the mounting bracket location is set lower

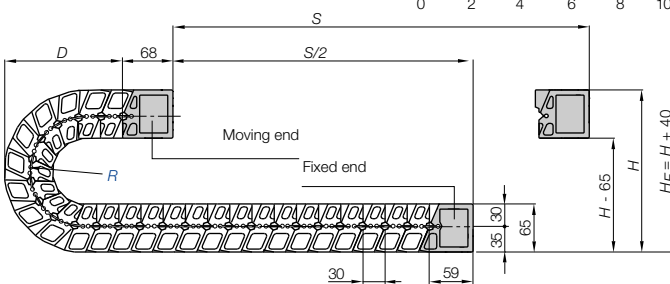

Other installation methods

- Vertical, hanging ≤ 50 m
- Vertical, standing ≤ 2 m
- Side mounted, unsupported
- = possible to a limited extent
- Unsupported length of upper run = upon request

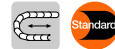

Short travels - unsupported

Unsupported E-Chains® feature positive camber over short travels. This must be accounted for when specifying the clearance height H_F . Please consult igus® if space is particularly restricted.

The required clearance height:
 $H_F = H + 40$ mm
 (with 2,0 kg/m fill weight)

Pitch = 30 mm/link Links/m = 34 (1020 mm) Chain length = $S/2 + K$

R	075	100	150	200	250
H (min.)	220	270	370	470	570
D	140	165	215	265	315
K	300	375	535	690	850
H ₂	140	140	140	140	140
D ₂ +25	270	398	768	1138	1508
K ₂	300	480	990	1470	1950

Long travel lengths from 6 m to max. 80 m Chain length = $S/2 + K_2$

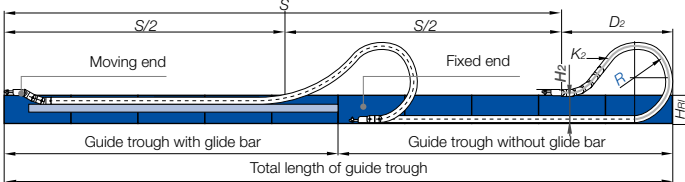

Gliding, long travel applications (max. 80 m)

In this case the E-Chain® upper run will be introduced in a guide trough on the lower run. We recommend to realize the engineering of such a plant by our technicians.

In case of travels between 4 and 6 m we recommend a longer unsupported length.

Technical Data

Speed / acceleration FL_G	max. 20 [m/s] / max. 200 [m/s ²]
Speed / acceleration FL_B	max. 3 [m/s] / max. 6 [m/s ²]
Gliding speed / acceleration (maximum)	upon request
permitted temperature °C	-40° up to +70° C
Flammability class	VDE 0304 IIC UL94 HB



Details of material properties

► page 1.38

For support of the lower run - **Support Tray tool kit** available ► page 9.70

52

System E6
Inner height: 52 mm

Phone +49- (0) 22 03-96 49-800
Fax +49- (0) 22 03-96 49-222



► page 8.39

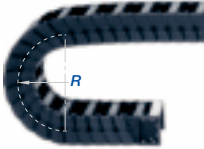
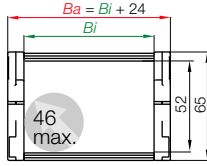

Part No. structure

E6.52.100.075.0

Series E6.52 - with crossbars every 2nd link

Part No.	B_j [mm]	B_a [mm]	R [mm]	Bending radii				Weight [kg/m]
E6.52.040.□.0	40	64	075	100	150	200	250	≈ 1,76
E6.52.050.□.0	50	74	075	100	150	200	250	≈ 1,80
E6.52.062.□.0	62	86	075	100	150	200	250	≈ 1,84
E6.52.070.□.0	70	94	075	100	150	200	250	≈ 1,87
E6.52.075.□.0	75	99	075	100	150	200	250	≈ 1,89
E6.52.087.□.0	87	111	075	100	150	200	250	≈ 1,94
E6.52.100.□.0	100	124	075	100	150	200	250	≈ 1,98
E6.52.125.□.0	125	149	075	100	150	200	250	≈ 2,07
E6.52.150.□.0	150	174	075	100	150	200	250	≈ 2,17
E6.52.175.□.0	175	199	075	100	150	200	250	≈ 2,26
E6.52.200.□.0	200	224	075	100	150	200	250	≈ 2,36
E6.52.225.□.0	225	249	075	100	150	200	250	≈ 2,45
E6.52.250.□.0	250	274	075	100	150	200	250	≈ 2,54
E6.52.275.□.0	275	299	075	100	150	200	250	≈ 2,64
E6.52.300.□.0	300	324	075	100	150	200	250	≈ 2,73

Supplement Part No. with required radius. Example: E6.52.100.075.0

0 = standard color, other colors ► page 1.39 · Pitch = 30 mm/link - Links/m = 34

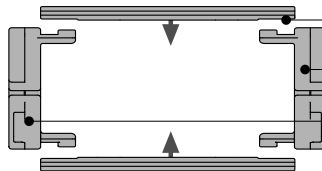

Part No. E-Chain® - links, single parts

Polymer spring as single part -
Part No. E6.52.195

Single crossbar, Part No. 225.Bi

Right side link*, single part, Part No. E6.52.02. R

Left side link*, single part, Part No. E6.52.01. R

*View from the fixed point

Option 1: Vertical separators and spacers

Vertical separators are used if a vertical subdivision of the E-Chain® interior is required -

By standard vertical separators are assembled every other E-Chain® link

- **Standard** subdivision with **Separator 382213**
- If a broad distance shall be kept between the separators, **Spacers 215.09** can be used. They are generally used on side-mounted E-Chains®

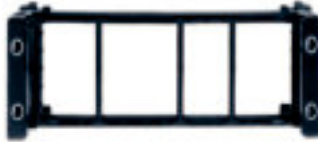
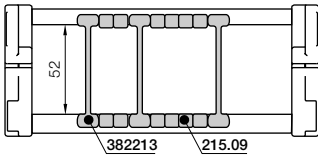

Separator	
unassembled	382212
assembled	382213



Spacer*	
unassembled	205.09
assembled	215.09

* for side-mounted applications

System E6
Inner height: 52 mm

Option 2: Full-width shelves

For applications involving many thin cables with similar or identical diameters

- **Slotted separators 38226** and **middle plate, slotted 38222** - for applications with **full-width shelf 321.X**
- **Locking vertical separator 382215** - for applications with **full-width shelf 221.X**

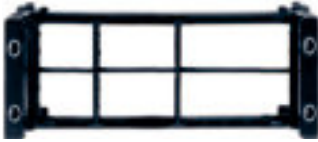
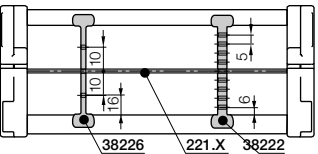

Slotted separator	
unassembled	38225
assembled	38226

Locking separator	
unassembled	38228
assembled	38229

Middle plate, slotted	
unassembled	38221
assembled	38222

Width X [mm]	Part No. unassembled	Part No. assembled
040	220.X 320.X	221.X 321.X
050	220.50 320.050	221.50 321.050
062	220.62 320.062	221.62 321.062
070	220.70 320.070	221.70 321.070
075	220.75 320.075	221.75 321.075
087	220.87 320.087	221.87 321.087

Width X [mm]	Part No. unassembled	Part No. assembled
100	220.X 320.X	221.X 321.X
125	220.125 320.125	221.125 321.125
150	220.150 320.150	221.150 321.150
175	220.175 320.175	221.175 321.175
200	220.200 320.200	221.200 321.200

Full-width shelf	
X - 1	220: t = 2,5
X - 1	320: t = 3,4

Option 3: Shelves

Shelves can be arranged elevator-shifted with different bottoms within the entire E-Chain® width

- Shelf **2210.X** for combinations with **middle plate 38222** (slotted, 9 times), **locking separator 382215** (slotted, 9 times) with higher retention force and **side plate 38224**

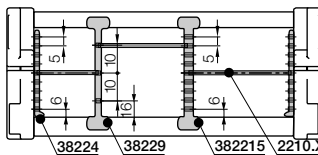

Locking separator	
unassembled	382214
assembled	382215

Side plate	
unassembled	38223
assembled	38224

Width X [mm]	Part No. unassembled	Part No. assembled
018	2200.18	2210.18
023	2200.23	2210.23
028	2200.28	2210.28
033	2200.33	2210.33
038	2200.38	2210.38
043	2200.43	2210.43
048	2200.48	2210.48

Width X [mm]	Part No. unassembled	Part No. assembled
058	2200.58	2210.58
068	2200.68	2210.68
073	2200.73	2210.73
088	2200.88	2210.88
099	2200.99	2210.99
124	2200.124	2210.124
149	2200.149	2210.149

Shelf	
X	X - 7
t = 2,5	

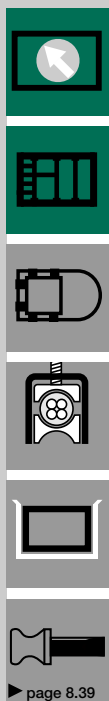

Phone +49- (0) 22 03-96 49-800
Fax +49- (0) 22 03-96 49-222

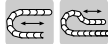

* KMA = Polymer Metal Mounting Bracket

Option KMA* - pivoting

- Option - integrated C-profile strain relief device with Chainfix clip or strain relief tiewrap plates
- C-profile mountable in the inner or outer radius of the E-Chain®
- Bolted connection outside of chain cross-section
- Recommended for unsupported and gliding applications
- Confined installation conditions
- Universal mountable with attachment capability on all sides

Moving end
E6.520...2

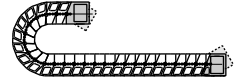

The attachment variants arising automatically by the choice of the KMA mounting bracket

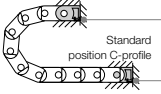

E6.520...1
Fixed end

Dimensions and order configurations

E6.520...2
Moving end

E6.520...1
Fixed end



Adapters for gliding applications available upon request

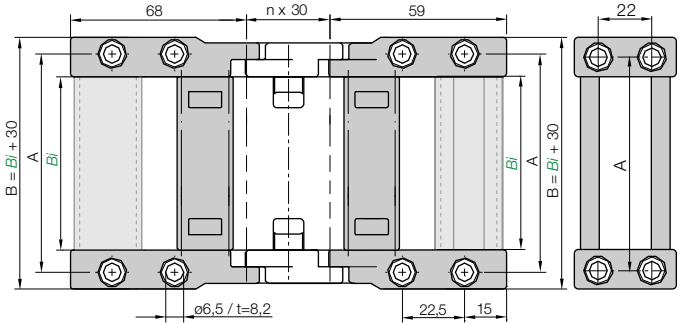

Phone +49- (0) 22 03-96 49-800
Fax +49- (0) 22 03-96 49-222

Part No. structure

E6.520.040.12.C

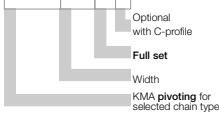

Full set, for both ends:

E6.520.040.12.C (with C-profile)

Single-part order:

E6.520.040.1.C (with C-profile)

Fixed end mounting bracket

E6.520.040.2.C (with C-profile)

Moving end mounting bracket

For E-Chain*	Part No. full set optional with C-profile	Dim. A [mm]	Dim. B [mm]
E6.52.040.	E6.520.040.12.C	56	70
E6.52.050.	E6.520.050.12.C	66	80
E6.52.062.	E6.520.062.12.C	78	92
E6.52.070.	E6.520.070.12.C	86	100
E6.52.075.	E6.520.075.12.C	91	105
E6.52.087.	E6.520.087.12.C	103	117
E6.52.100.	E6.520.100.12.C	116	130
E6.52.125.	E6.520.125.12.C	141	155

For E-Chain*	Part No. full set optional with C-profile	Dim. A [mm]	Dim. B [mm]
E6.52.150.	E6.520.150.12.C	166	180
E6.52.175.	E6.520.175.12.C	191	205
E6.52.200.	E6.520.200.12.C	216	230
E6.52.225.	E6.520.225.12.C	241	255
E6.52.250.	E6.520.250.12.C	266	280
E6.52.275.	E6.520.275.12.C	291	300
E6.52.300.	E6.520.300.12.C	316	330

igus® GmbH
51147 Cologne

Other strain relief elements

E6 | E-Tube | Series E6.52 | Accessories | Strain Relief

Strain relief tiewrap plate can be fixed on the last crossbar, alternatively with C-profile. Tiewrap plate as individual part - Part No. 30XX.ZB. Further strain relief elements ► chapter 10



Other strain relief elements - optional ► chapter 10



Internet: www.igus.eu
E-mail: info@igus.de

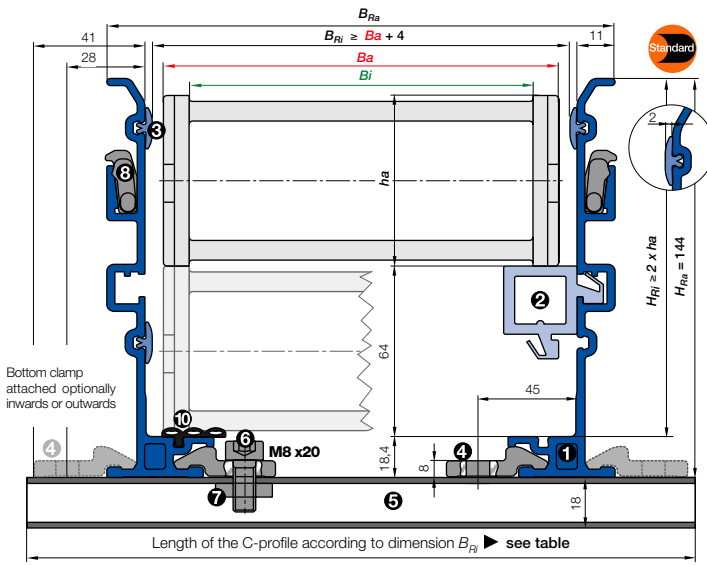

- Ba = Outer width E-Chains / E-Tube
- Bi = Inner width E-Chains / E-Tube
- ha = Outer height E-Chains / E-Tube
- H_{ri} = Inner trough height
- H_{ra} = Outer trough height
- B_{ri} = Inner trough width ▶ depends on dim. Ba
- B_{ra} = Outer trough width
- n_{Mon} = Number of installation sets (left/right)
- n_{ri} = Number of trough sets (left/right)
- $H_{ri} \geq 2 \cdot ha$
 $B_{ri} \geq Ba + 4$
- = Guide trough set ● = Glide bar
- = Installation set "Basic" ● = C-profile

Installation set "Basic" with C-profile

Bottom Clamp attached optionally inwards or outwards ▶

E6.52.040.200.0 ▶ Order example

B_{ri} [mm]	Part No.	
	attached inwards	attached outwards
.040	68	960.40.200
.050	78	960.40.200
.062	90	960.40.225
.070	98	960.40.225
.075	103	960.40.225
.087	115	960.40.250
.100	128	960.40.175 960.40.250
.125	153	960.40.200 960.40.275
.150	178	960.40.225 960.40.300
.175	203	960.40.250 960.40.325
.200	228	960.40.275 960.40.350
.225	253	960.40.300 960.40.375
.250	278	960.40.325 960.40.400
.275	303	960.40.350 960.40.425
.300	328	960.40.375 960.40.450



- **Components, trough "Basic":** ① Trough side parts, aluminum, 2 m ② Glide bar, plastic, 2 m ③ Glide strips, plastic, 2 m (without glide strips on request) ⑩ Optional: Silencer profile, rubber
- **Components, installation set "Basic":** ④ Bottom clamp, aluminum ⑤ C-profile, steel galvanized ⑥ Screw M8 x20 ⑦ Sliding nut M8 ⑧ Interface connector, plastic



Order example: Length of travel 30 m - Center mounted for Series E6.52.100.200.0 with $B_{ri} = 128$

- Guide trough set (set of 2 trough side parts, incl. glide strips) **without** glide bar
Order text: 16 m guide trough without glide bar (8 x 2 m sections) Part No. **973.30.SL**
- Guide trough set (set of 2 trough side parts, incl. glide strips) **with** glide bar
Order text: 16 m guide trough with glide bar (8 x 2 m sections) Part No. **973.31.SL**
- Installation set "Basic" complete (guide trough-sets + 1)
Order text: 17 installation sets "Basic" Part No. **960.40.175**
- Module for the fixed end
Order text: 1 set Part No. **973.81**
- Option: For an additional noise dampening with silencer profile, please add Index A - Example:
Part No. 973.30.SLA

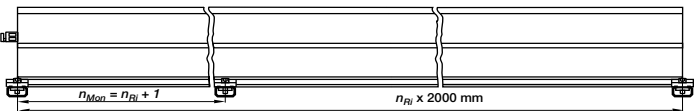

Principle sketch: Number of installation sets to be installed = **Number of trough sections + 1**

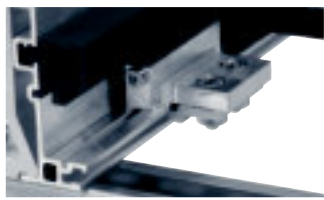

A quick fix for mounting the stationary end of an E-Chain®
 With this module for the fixed end, fast and easy mounting onto the Aluminum "SuperTrough" is now possible without any drilling. Fast mounting of the E-Chain® by clamping onto the aluminum trough
 ● Quick relocation of the stationary end ● No drilling necessary ▶ **page 9.16**

Insert for the installation set "Heavy-Duty": **973.50.XXX** instead of **960.40.XXX** on the right column "attached outwards"

Phone +49- (0) 22 03-96 49-800
 Fax +49- (0) 22 03-96 49-222

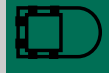

▶ page 8.39

● ● ● Price index



Extremely low noise
Test results upon request



IPA certificate: Class 1, according to standard DIN EN ISO 14644-1 for the E6 system (Series E6.29.060.150.0.CR, $v = 0.5 \text{ m/s}$, $a = 1.0 \text{ m/s}^2$)



LEVEL 1 absorption confirmed by IPA-Fraunhofer-Institut according to SEMI E78-0998 for the E6 standard material



Lever and remove lids



When to use the Series R6.52:

- Protection against dirt and chips
- If a low-noise version is required
- At very high speeds and/or accelerations
- For enlarged thrusts and tensile forces
- For small bending radii
- If less vibration is required
- Minimal abrasion
(e.g. cleanroom applications)



When not to use it:

- Limited in side-mounted applications
▶ Series R4.42 System E4.1, page 7.48

- ① No pin and bore connection
- ② Can be shortened or lengthened due to modular design
- ③ Small pitch for low-noise, smooth operation
- ④ Continuous glide surfaces
- ⑤ Smooth, cable-protecting inner chamber
- ⑥ Interior stop dog
- ⑦ Very large gliding surfaces
- ⑧ Enclosed design protects from light debris, weld splatter and compromising environmental influences
- ⑨ KMA-Mounting Brackets with attachment points on all sides
- ⑩ Optional with or without integrated C-profile

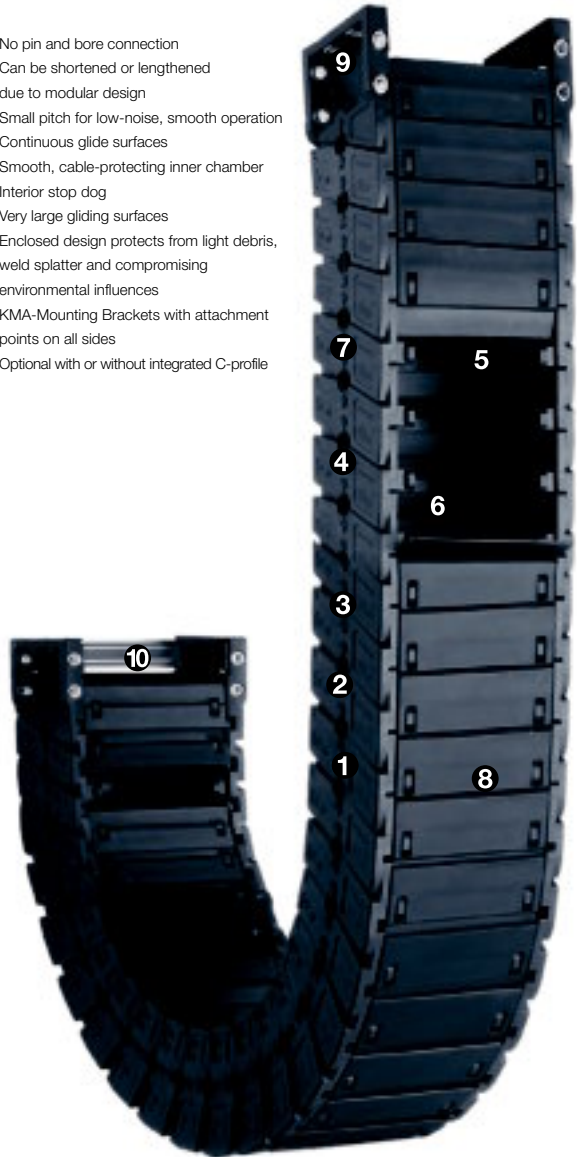

Order example complete E-Chain®

Please indicate chain-lengths or number of links Example: 2 m or 68 links

2 m R6.52.100.075.0

E-Tube

with 2 separators R6.52.11 assembled every 2nd link

Interior separation

1 set R6.520.100.12

Mounting bracket



Unsupported length

FL_G = with straight upper run

FL_B = with permitted sag

Further information ► **Design, page 1.12**

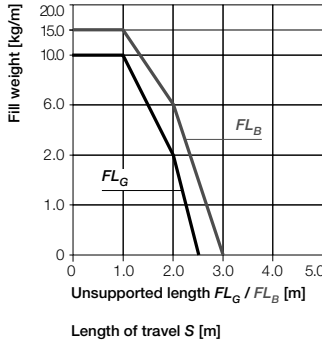
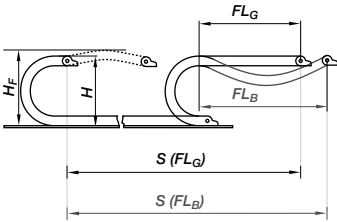

- S = Length of travel
 - R = Bending radius
 - H = Nominal clearance height
 - H_F = Required clearance height
 - H_{RI} = Trough inner height
 - D = Overlength E-Chain® radius in final position
 - $K = \pi \cdot R + \text{"safety"}$
 - D_2 = Over length - long travels, gliding
 - K_2 = "Further add-on"
 - H_2 = "Mounting height"
- *if the mounting bracket location is set lower

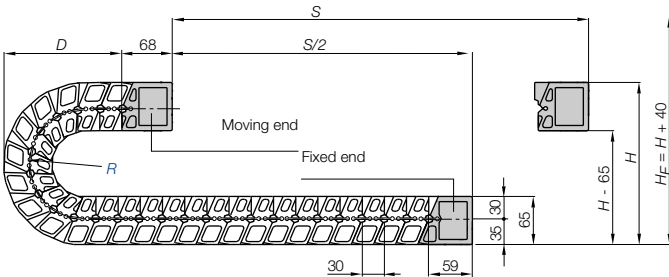

Pitch = 30 mm/link Links/m = 34 (1020 mm) Chain length = $S/2 + K$

R	075	100	150	200	250
H (min.)	220	270	370	470	570
D	140	165	215	265	315
K	300	375	535	690	850
H ₂	140	140	140	140	140
D ₂ +25	270	398	768	1138	1508
K ₂	300	480	990	1470	1950

If you intend to use this series on long travels, we request you to consult us!

Long travel lengths from 6 m to max. 80 m Chain length = $S/2 + K_2$

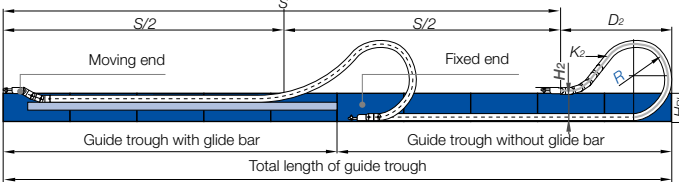

In case of travels between 4 m and 6 m we recommend a longer unsupported length.

Other installation methods

- Vertical, hanging ≤ 50 m
- Vertical, standing ≤ 2 m
- Side mounted, unsupported = possible to a limited extent
- Unsupported length of upper run = upon request



Short travels - unsupported

Unsupported E-Chains® feature positive camber over short travels. This must be accounted for when specifying the clearance height H_F . Please consult igus® if space is particularly restricted.

The required clearance height:
 $H_F = H + 40$ mm
 (with 2,0 kg/m fill weight)



Gliding, long travel applications (max. 80 m)

In this case the E-Chain® upper run will be introduced in a guide trough on the lower run. We recommend to realize the engineering of such a plant by our technicians.

Technical Data

Speed / acceleration FL_G	max. 20 [m/s] / max. 200 [m/s ²]
Speed / acceleration FL_B	max. 3 [m/s] / max. 6 [m/s ²]
Gliding speed / acceleration (maximum)	upon request
permitted temperature °C	-40° up to +70° C
Flammability class	VDE 0304 IIC UL94 HB



Details of material properties

► page 1.38



System E6
Inner height: 52 mm

Phone +49- (0) 22 03-96 49-800
Fax +49- (0) 22 03-96 49-222



► page 8.39



For support of the lower run - **Support Tray tool kit** available ► page 9.70

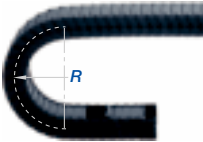
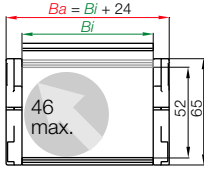

Serie R6.52 E-Tube, lids can be removed along inner and outer radius

Part No.	Bj [mm]	Ba [mm]	R [mm]	Bending radii				Weight [kg/m]
R6.52.040.□.0	40	64	075	100	150	200	250	≈ 1,78
R6.52.050.□.0	50	74	075	100	150	200	250	≈ 1,89
R6.52.062.□.0	62	86	075	100	150	200	250	≈ 1,97
R6.52.070.□.0	70	94	075	100	150	200	250	≈ 2,07
R6.52.075.□.0	75	99	075	100	150	200	250	≈ 2,12
R6.52.087.□.0	87	111	075	100	150	200	250	≈ 2,21
R6.52.100.□.0	100	124	075	100	150	200	250	≈ 2,35
R6.52.125.□.0	125	149	075	100	150	200	250	≈ 2,57
R6.52.150.□.0	150	174	075	100	150	200	250	≈ 2,80
R6.52.175.□.0	175	199	075	100	150	200	250	≈ 3,03
R6.52.200.□.0	200	224	075	100	150	200	250	≈ 3,25
R6.52.225.□.0	225	249	075	100	150	200	250	≈ 3,46
R6.52.250.□.0	250	274	075	100	150	200	250	≈ 3,68
R6.52.275.□.0	275	299	075	100	150	200	250	≈ 3,92
R6.52.300.□.0	300	324	075	100	150	200	250	≈ 4,15

The widths 040 / 062 / 062 / 070 / 200 / 225 / 250 / 275 / 300 are available upon request.

Time of delivery approx. 6-8 weeks after order.

Supplement Part No. with required radius. Example: R6.52.100.□075.0

0 = standard color, other colors ▶ page 1.39 · Pitch = 30 mm/link - Links/m = 34

Part No. structure

R6.52.100.075.0



E6 | E-Tube | Series R6.52 | Accessories | Interior Separation

Trennsteg

unassembled R6.52.01

assembled R6.52.11



Option 1: Vertical separators

Vertical separators are used if a vertical subdivision of the E-Chain® interior is required - By standard vertical separators are assembled every other E-Chain® link!

- The notches on this separator marks the sticking side for a stuck mounting on the lid
- Standard subdivision with vertical separator R6.52.11



Separator,
R6.52.01
(side view)

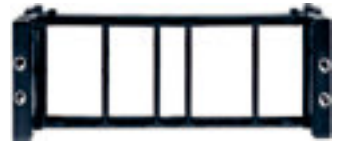
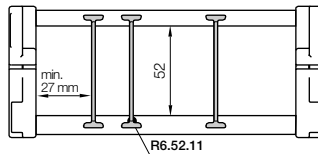

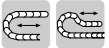

* KMA = Polymer Metal Mounting Bracket

Option KMA* - pivoting

- Option - integrated C-profile strain relief device with Chainfix clip or strain relief tiwrap plates
- C-profile mountable in the inner or outer radius of the E-Chain*
- Bolted connection outside of chain cross-section
- Recommended for unsupported and gliding applications
- Confined installation conditions
- Universal mountable with attachment capability on all sides

Moving end
R6.520...2

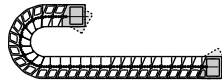

The attachment variants arising automatically by the choice of the KMA mounting bracket

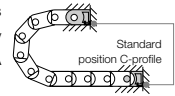

R6.520...1
Fixed end

R6.520...2
Fixed end

R6.520...1
Moving end

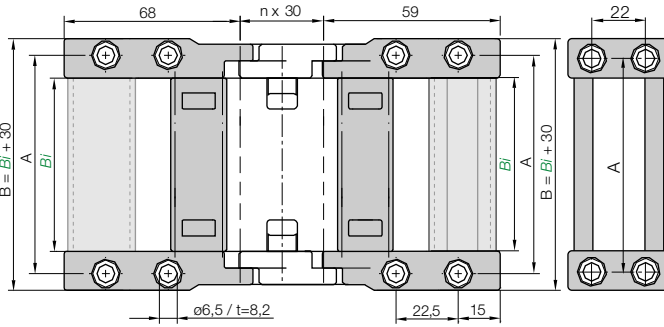

Dimensions and order configurations

For E-Chain*	Part No. full set optional with C-profile	Dim. A [mm]	Dim. B [mm]
R6.52.040.	R6.520.040.12.C	56	70
R6.52.050.	R6.520.050.12.C	66	80
R6.52.062.	R6.520.062.12.C	78	92
R6.52.070.	R6.520.070.12.C	86	100
R6.52.075.	R6.520.075.12.C	91	105
R6.52.087.	R6.520.087.12.C	103	117
R6.52.100.	R6.520.100.12.C	116	130
R6.52.125.	R6.520.125.12.C	141	155

For E-Chain*	Part No. full set optional with C-profile	Dim. A [mm]	Dim. B [mm]
R6.52.150.	R6.520.150.12.C	166	180
R6.52.175.	R6.520.175.12.C	191	205
R6.52.200.	R6.520.200.12.C	216	230
R6.52.225.	R6.520.225.12.C	241	255
R6.52.250.	R6.520.250.12.C	266	280
R6.52.275.	R6.520.275.12.C	291	300
R6.52.300.	R6.520.300.12.C	316	330

Part No. structure

R6.520.050.12.C



Full set, for both ends:
R6.520.050.12.C (with C-profile)
 Single-part order:
R6.520.050.1.C (with C-profile)
 Fixed end mounting bracket
R6.520.050.2.C (with C-profile)
 Moving end mounting bracket

Phone +49- (0) 22 03-96 49-800
 Fax +49- (0) 22 03-96 49-222

E6 | E-Tube | Series R6.52 | Accessories | Strain Relief

Strain relief tiwrap plate can be fixed on the last crossbar, alternatively with C-profile. Tiwrap plate as individual part - Part No. 30XX.ZB. Further strain relief elements ► chapter 10



Other strain relief elements - optional ► chapter 10

Chapter 10
 Trough E6.52
 page 8.71
 page 8.39



Price index



Extremely low noise
Test results upon request



IPA certificate: Class 1, according to standard DIN EN ISO 14644-1 for the E6 system (Series E6.29.060.150.0.CR, $v = 0.5 \text{ m/s}$, $a = 1.0 \text{ m/s}^2$)



LEVEL 1 absorption confirmed by IPA-Fraunhofer-Institut according to SEMI E78-0998 for the E6 standard material



To close, push and click shut



When to use the Series E6.62:

- If a low-noise version is required
- At very high speeds and/or accelerations
- For enlarged thrusts and tensile forces
- For small bending radii
- If less vibration is required
- Minimal abrasion
(e.g. cleanroom applications)



When not to use it:

- Limited in side-mounted applications
 - ▶ Series E4.56 System E4.1, page 7.62
- No use with RBR (reverse bending radius)
 - ▶ Series E4.56 System E4.1, page 7.62
- No use with high additional loads
 - ▶ Series E4.56 System E4.1, page 7.62
- No use in dirty environments
 - ▶ Series E4.56 System E4.1, page 7.62

- ① No pin and bore connection
- ② Interior stop dog
- ③ Small pitch for low-noise, smooth operation
- ④ Can be shortened or lengthened due to modular design
- ⑤ Very large gliding surfaces
- ⑥ Increased inner height
- ⑦ KMA-Mounting Brackets with attachment points on all sides
- ⑧ Optional with or without integrated C-profile
- ⑨ Series R6.62 - E-Tube-version available on request

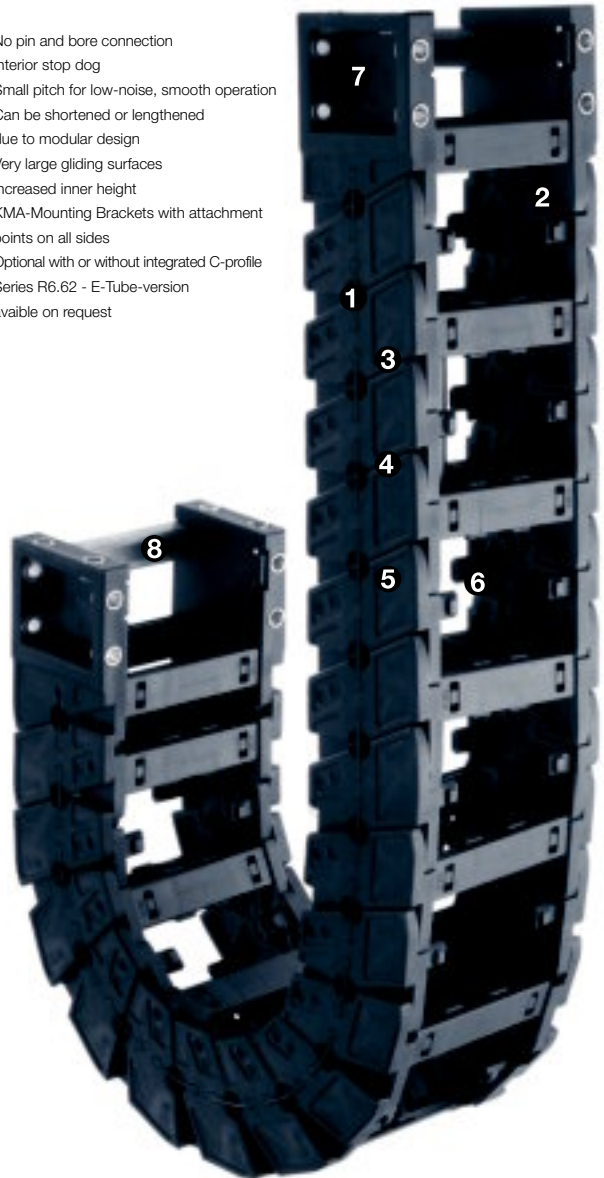

Order example complete E-Chain®

Please indicate chain-lengths or number of links **Example: 3 m or 60 links**

3 m **E6.62.10.200.0**

E-Chain®

with 2 separators **E6.62.11** assembled every 2" link

Interior separation

1 set **E6.620.10.12C**

Mounting bracket



Unsupported length

FL_G = with straight upper run

FL_B = with permitted sag

Further information ► **Design, page 1.12**

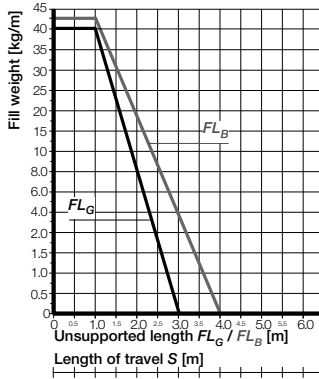
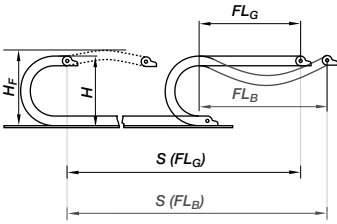

- S = Length of travel
 - R = Bending radius
 - H = Nominal clearance height
 - H_F = Required clearance height
 - H_{RI} = Trough inner height
 - D = Overlength E-Chain® radius in final position
 - $K = \pi \cdot R$ + "safety"
 - D_2 = Over length - long travels, gliding
 - K_2 = "Further add-on"
 - H_2 = "Mounting height"
- *if the mounting bracket location is set lower

Other installation methods

- Vertical, hanging ≤ 60 m
- Vertical, standing ≤ 3 m
- Side mounted, unsupported
- = possible to a limited extent
- Unsupported length of upper run = upon request

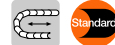

Short travels - unsupported

Unsupported E-Chains® feature positive camber over short travels. This must be accounted for when specifying the clearance height H_F . Please consult igus® if space is particularly restricted.

The required clearance height:
 $H_F = H + 80$ mm
 (with 2,0 kg/m fill weight)

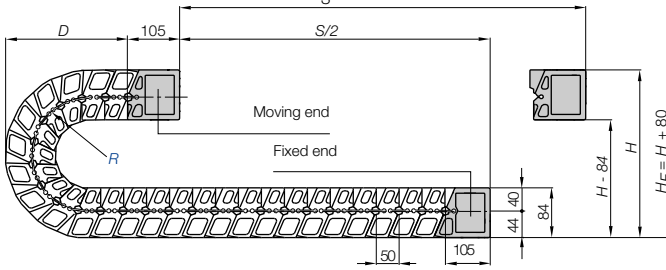

Pitch = 50 mm/link Links/m = 20 (1000 mm) Chain length = $S/2 + K$

R	115	150	200	250	300	350
H (min.)	318	388	488	588	688	788
D	209	244	294	344	394	444
K	465	575	730	890	1045	1200
H ₂	140	140	140	140	140	140
D ₂ +25	463	498	1012	1314	1616	1918
K ₂	550	650	1300	1700	2150	2600

If you intend to use this series on long travels, we request you to consult us!

Long travel lengths from 10 m to max. 100 m Chain length = $S/2 + K_2$

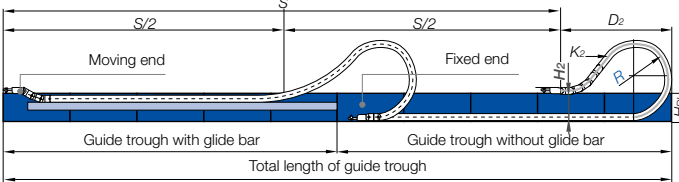

Gliding, long travel applications (max. 100 m)

In this case the E-Chain® upper run will be introduced in a guide trough on the lower run. We recommend to realize the engineering of such a plant by our technicians.

In case of travels between 4 m and 10 m we recommend a longer unsupported length.

Technical Data

Speed / acceleration FL_G	max. 20 [m/s] / max. 200 [m/s ²]
Speed / acceleration FL_B	max. 3 [m/s] / max. 6 [m/s ²]
Gliding speed / acceleration (maximum)	upon request
permitted temperature °C	-40° up to +70° C
Flammability class	VDE 0304 IIC UL94 HB



Details of material properties
 ► page 1.38



For support of the lower run - **Support Tray tool kit** available ► page 9.70

62

System E6
 Inner height: 62 mm

Phone +49- (0) 22 03-96 49-800
 Fax +49- (0) 22 03-96 49-222

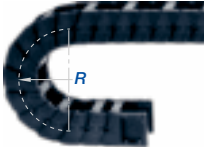
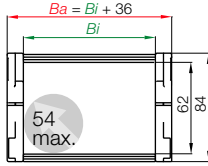

► page 8.39

Series E6.62 - with crossbars every 2nd link

Part No.	Bi [mm]	Ba [mm]	R [mm]	Bending radii					Weight [kg/m]
E6.62.05.	50	86	115	150	200	250	300	350	≈ 3,22
E6.62.06.	68	104	115	150	200	250	300	350	≈ 3,28
E6.62.07.	75	111	115	150	200	250	300	350	≈ 3,31
E6.62.087.	87	123	115	150	200	250	300	350	≈ 3,35
E6.62.10.	100	136	115	150	200	250	300	350	≈ 3,39
E6.62.11.	108	144	115	150	200	250	300	350	≈ 3,42
E6.62.112.	112	148	115	150	200	250	300	350	≈ 3,43
E6.62.12.	125	161	115	150	200	250	300	350	≈ 3,48
E6.62.137.	137	173	115	150	200	250	300	350	≈ 3,52
E6.62.15.	150	186	115	150	200	250	300	350	≈ 3,57
E6.62.162.	162	198	115	150	200	250	300	350	≈ 3,61
E6.62.17.	168	204	115	150	200	250	300	350	≈ 3,63
E6.62.18.	175	211	115	150	200	250	300	350	≈ 3,65
E6.62.187.	187	223	115	150	200	250	300	350	≈ 3,69
E6.62.20.	200	236	115	150	200	250	300	350	≈ 3,74
E6.62.212.	212	248	115	150	200	250	300	350	≈ 3,78
E6.62.23.	225	261	115	150	200	250	300	350	≈ 3,83
E6.62.237.	237	273	115	150	200	250	300	350	≈ 3,87
E6.62.25.	250	286	115	150	200	250	300	350	≈ 3,91
E6.62.262.	262	298	115	150	200	250	300	350	≈ 3,95
E6.62.28.	275	311	115	150	200	250	300	350	≈ 4,00
E6.62.29.	287	323	115	150	200	250	300	350	≈ 4,04
E6.62.30.	300	336	115	150	200	250	300	350	≈ 4,09
E6.62.312.	312	348	115	150	200	250	300	350	≈ 4,13
E6.62.325.	325	361	115	150	200	250	300	350	≈ 4,17
E6.62.337.	337	373	115	150	200	250	300	350	≈ 4,21
E6.62.350.	350	386	115	150	200	250	300	350	≈ 4,26
E6.62.362.	362	398	115	150	200	250	300	350	≈ 4,30
E6.62.375.	375	411	115	150	200	250	300	350	≈ 4,35
E6.62.387.	387	423	115	150	200	250	300	350	≈ 4,39
E6.62.400.	400	436	115	150	200	250	300	350	≈ 4,43

Supplement Part No. with required radius. Example: E6.62.237. 150.0

0 = standard color, other colors ► page 1.39 · Pitch = 50 mm/link · Links/m = 20

Part No. structure

E6.62.237. 150.0

Part No. E-Chain® - links, single parts

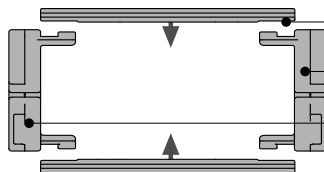
Polymer spring as single part -
Part No. E6.62.340

Single crossbar, Part No. 385.Bi

Right side link*, single part, Part No. E6.62.02. RLeft side link*, single part, Part No. E6.62.01. R

*View from the fixed point

Option 1: Vertical separators and spacers

Vertical separators are used if a vertical subdivision of the E-Chain® interior is required -

By standard vertical separators are assembled every other E-Chain® link

- **Standard separator 417** offers safe stability due to its wide base design, even when used with large diameter cables or hoses
 - If a broad distance shall be kept between the separators or they have to be fixed in their position, e.g. in case of side mounted applications, **Spacers 382.10, 382.15 and 382.20** can be used
- Instruction:** The available interior height is reduced by 2 mm per spacer, and can hence amount to 4 mm when spacers are fitted on both sides. To avoid this, the parts can also be installed from the outside on the opening crossbar. (no long travels)

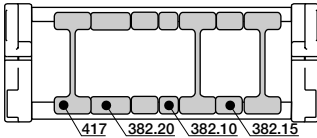

Vertical separator	
unassembled	407
assembled	417



Spacer*	
unassembled	381.10
assembled	382.10
unassembled	381.15
assembled	382.15
unassembled	381.20
assembled	382.20

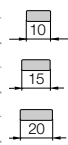

* for side-mounted applications

Option 2: Full-width shelves

For applications involving many thin cables with similar or identical diameters

- **Vertical separator, slotted E6.62.11** - for applications with full-width shelf 321.X

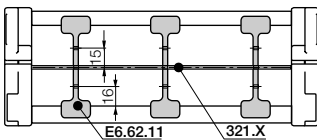

Vertical separator, slotted	
unassembled	E6.62.01
assembled	E6.62.11



Width X [mm]	Part No. unassem.	Part No. assem.	Width X [mm]	Part No. unassem.	Part No. assem.
050	320.50	321.50	108	320.108	321.108
068	320.68	321.68	112	320.112	321.112
075	320.75	321.75	125	320.125	321.125
087	320.87	321.87	137	320.137	321.137
100	320.100	321.100	150	320.150	321.150

Width X [mm]	Part No. unassem.	Part No. assem.	Width X [mm]	Part No. unassem.	Part No. assem.
162	320.162	321.162	212	320.212	321.212
168	320.168	321.168	225	320.225	321.225
175	320.175	321.175	237	320.237	321.237
187	320.187	321.187	250	320.250	321.250
200	320.200	321.200			

Full-width shelf	
Width	X-1
Thickness	t = 3,4

Option 3: Shelves

Shelves can be arranged elevator-shifted with different bottoms within the entire E-Chain® width They can be arranged at 7 different heights (in 7 mm increments)

- Shelf 387.X can be combined with middle plate 149 and side plate 147
- ▶ Design, chapter 1 for layout recommendations.
- Slotted separators 1417 are used for complex subdivisions.

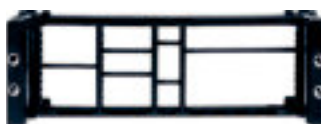
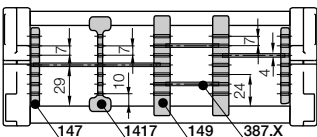

Width X [mm]	Part No. unassembled	Part No. assembled
018	386.18	387.18
023	386.23	387.23
025	386.25	387.25
028	386.28	387.28
033	386.33	387.33
043	386.43	387.43
050	386.50	387.50
054	386.54	387.54
062	386.62	387.62

Width X [mm]	Part No. unassembled	Part No. assembled
075	386.75	387.75
087	386.87	387.87
100	386.100	387.100
108	386.108	387.108
125	386.125	387.125
150	386.150	387.150
175	386.175	387.175
200	386.200	387.200
208	386.208	387.208

Middle plate	
unassembled	148
assembled	149



Side plate	
unassembled	146
assembled	147



Slotted separator**	
unassembled	1407
assembled	1417



**retrofit of an existing interior shelving not possible without disassembling of the parts

Shelf	
Width	X - 8
Thickness	t = 4

System E6
Inner height: 62 mm

Phone +49- (0) 22 03-96 49-800
Fax +49- (0) 22 03-96 49-222



▶ page 8.39



The attachment variants arising automatically by the choice of the KMA mounting bracket

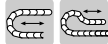
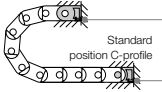

* KMA = Polymer Metal Mounting Bracket

Option KMA* - pivoting

- Option - integrated C-profile strain relief device with Chainfix clip or strain relief tiewrap plates
- C-profile mountable in the inner or outer radius of the E-Chain®
- Bolted connection outside of chain cross-section
- Recommended for unsupported and gliding applications
- Confined installation conditions
- Universal mountable with attachment capability on all sides

Moving end
E6.620...2

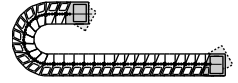

E6.620...1
Fixed end

Dimensions and order configurations



Adapters for gliding applications available upon request

E6.620...2
Moving end

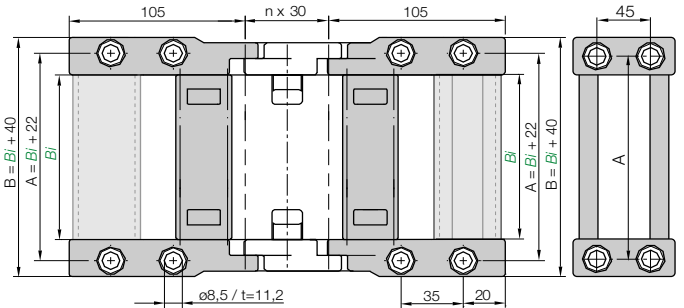

E6.620...1
Fixed end

Phone +49- (0) 22 03-96 49-800
Fax +49- (0) 22 03-96 49-222

igus® GmbH
51147 Cologne

Part No. structure

E6.620. 05. 12. C

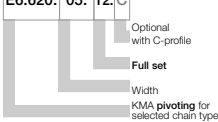

Full set, for both ends:

E6.620. 05. 12. C (with C-profile)

Single-part order:

E6.620. 05. 1. C (with C-profile)

Fixed end mounting bracket

E6.620. 05. 2. C (with C-profile)

Moving end mounting bracket

For E-Chain*	Part No. full set optional with C-profile	Bi [mm]
E6.62.05.	E6.620.05.12. C	50
E6.62.06.	E6.620.06.12. C	68
E6.62.07.	E6.620.07.12. C	75
E6.62.087.	E6.620.087.12. C	087
E6.62.10.	E6.620.10.12. C	100
E6.62.11.	E6.620.11.12. C	108
E6.62.112.	E6.620.112.12. C	112
E6.62.12.	E6.620.12.12. C	125
E6.62.137.	E6.620.137.12. C	137
E6.62.15.	E6.620.15.12. C	150
E6.62.162.	E6.620.162.12. C	162
E6.62.17.	E6.620.17.12. C	168
E6.62.18.	E6.620.18.12. C	175
E6.62.187.	E6.620.187.12. C	187
E6.62.20.	E6.620.20.12. C	200
E6.62.212.	E6.620.212.12. C	212

For E-Chain*	Part No. full set optional with C-profile	Bi [mm]
E6.62.23.	E6.620.23.12. C	225
E6.62.237.	E6.620.237.12. C	237
E6.62.25.	E6.620.25.12. C	250
E6.62.262.	E6.620.262.12. C	262
E6.62.28.	E6.620.28.12. C	275
E6.62.29.	E6.620.29.12. C	287
E6.62.30.	E6.620.30.12. C	300
E6.62.312.	E6.620.312.12. C	312
E6.62.325.	E6.620.325.12. C	325
E6.62.337.	E6.620.337.12. C	337
E6.62.350.	E6.620.350.12. C	350
E6.62.362.	E6.620.362.12. C	362
E6.62.375.	E6.620.375.12. C	375
E6.62.387.	E6.620.387.12. C	387
E6.62.400.	E6.620.400.12. C	400

E6 | E-Tube | Series E6.62 | Accessories | Strain Relief

Strain relief tiewrap plate can be fixed on the last crossbar, alternatively with C-profile. Tiewrap plate as individual part - Part No. 30XX.ZB. Further strain relief elements ▶ chapter 10



Other strain relief elements - optional ▶ chapter 10



Internet: www.igus.eu
E-mail: info@igus.de

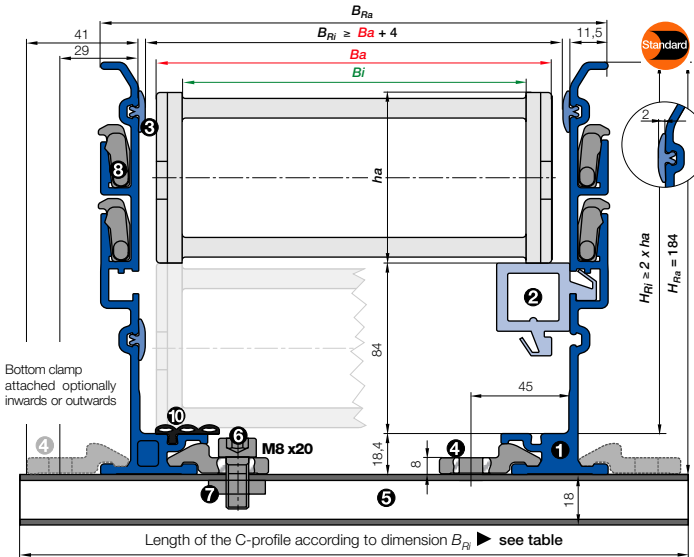

- B_a = Outer width E-Chains® / E-Tube
- B_i = Inner width E-Chains® / E-Tube
- h_a = Outer height E-Chains® / E-Tube
- H_{Ri} = Inner trough height
- H_{Ra} = Outer trough height
- B_{Ri} = Inner trough width ▶ depends on dim. B_a
- B_{Ra} = Outer trough width
- n_{Mon} = Number of installation sets (left/right)
- n_{Ri} = Number of trough sets (left/right)
- $H_{Ri} \geq 2 \cdot h_a$
 $B_{Ri} \geq B_a + 4$
- = Guide trough set ● = Glide bar
- = Installation set "Basic" ● = C-profile

Installation set "Basic" with C-profile

Bottom Clamp attached optionally inwards or outwards

E6.62.05.200.0 ▶ Order example

B_{Ri} [mm]	attached inwards	attached outwards
.05	90	-
.06	108	-
.07	115	-
.087	127	960.50.175
.10	140	960.50.200
.11	148	960.50.200
.112	152	960.50.200
.12	165	960.50.225
.137	177	960.50.225
.15	190	960.50.250
.162	202	960.50.250
.17	208	960.50.275
.18	215	960.50.275
.187	227	960.50.275
.20	240	960.50.300
.212	252	960.50.300
.23	265	960.50.325
.237	277	960.50.325
.25	290	960.50.350
.262	302	960.50.350
.28	315	960.50.375
.29	327	960.50.375
.30	340	960.50.400
.312	352	960.50.400
.325	365	960.50.425
.337	377	960.50.425
.350	390	960.50.450
.362	402	960.50.450
.375	415	960.50.475
.387	427	960.50.475
.400	440	960.50.500



- **Components, trough "Basic":** ① Trough side parts, aluminum, 2 m ② Glide bar, plastic, 2 m ③ Glide strips, plastic, 2 m (without glide strips on request) ⑩ Optional: Silencer profile, rubber
- **Components, installation set "Basic":** ④ Bottom clamp, aluminum ⑤ C-profile, steel galvanized ⑥ Screw M8 x20 ⑦ Sliding nut M8 ⑧ Interface connector, plastic



Order example: Length of travel 30 m - Center mounted for Series E6.62.087.200.0 with $B_{Ri} = 127$

- Guide trough set (set of 2 trough side parts, incl. glide strips) **without** glide bar
Order text: 16 m guide trough without glide bar (8 x 2 m sections) Part No. **974.30.SL**
- Guide trough set (set of 2 trough side parts, incl. glide strips) **with** glide bar
Order text: 16 m guide trough with glide bar (8 x 2 m sections) Part No. **974.31.SL**
- Installation set "Basic" complete (guide trough-sets + 1)
Order text: 17 installation sets "Basic" Part No. **960.50.175**
- Module for the fixed end
Order text: 1 set Part No. **974.80**
- Option: For an additional noise dampening with silencer profile, please add Index A - Example:
Part No. 974.30.SLA

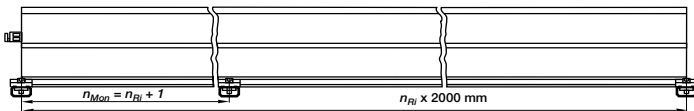

Principle sketch: Number of installation sets to be installed = Number of trough sections + 1



A quick fix for mounting the stationary end of an E-Chain®

With this module for the fixed end, fast and easy mounting onto the Aluminum "SuperTrough" is now possible without any drilling. Fast mounting of the E-Chain® by clamping onto the aluminum trough

- Quick relocation of the stationary end
- No drilling necessary ▶ page 9.16

Insert for the installation set "Heavy-Duty": **974.50.XXX** instead of (**960.50.XXX**) on the right column "attached outwards"



▶ Chapter 10



▶ Chapter 9



▶ page 8.39



Price index



Extremely low noise
Test results upon request



IPA certificate: Class 1, according to standard DIN EN ISO 14644-1 for the E6 system (Series E6.29.060.150.0.CR, $v = 0.5 \text{ m/s}$, $a = 1.0 \text{ m/s}^2$)



LEVEL 1 absorption confirmed by IPA-Fraunhofer-Institut according to SEMI E78-0998 for the E6 standard material



To close, push and click shut



When to use the Series E6.80L:

- If a low-noise version is required
- At very high speeds and/or accelerations
- For enlarged thrusts and tensile forces
- For small bending radii
- If less vibration is required
- Minimal abrasion
(e.g. cleanroom applications)



When not to use it:

- Limited in side-mounted applications
 - ▶ Series 15050 System E4/light, page 7.144
- No use with RBR (reverse bending radius)
 - ▶ Series 15050 System E4/light, page 7.144
- No use with high additional loads
 - ▶ Series 15050 System E4/light, page 7.144

- ① 45% lighter in weight compared to the Series E6.80
- ② Can be shortened or lengthened due to modular design
- ③ Continuous glide surfaces
- ④ No pin and bore connection
- ⑤ Interior stop dog
- ⑥ Small pitch for low-noise, smooth operation
- ⑦ KMA mounting brackets with attachment points on all sides (strain relief with separate tie-wrap plates possible)
- ⑧ Increased inner height
- ⑨ Optional with or without integrated C-profile

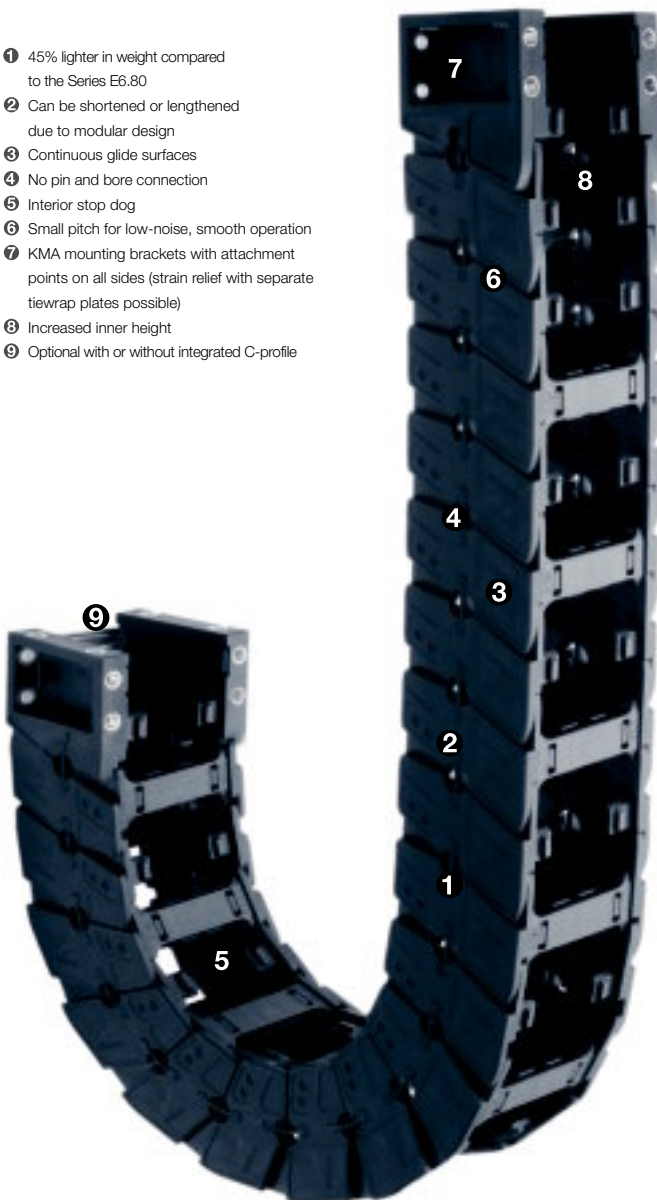

Order example complete E-Chain®

Please indicate chain-lengths or number of links Example: 5 m or 80 links

5 m E6.80L.15.175.0

 E-Chain®

with 2 separators 511 assembled every 2nd link

 Interior separation

1 set E6.800L.15.12

 Mounting bracket



Unsupported length

FL_G = with straight upper run

FL_B = with permitted sag

Further information ► **Design, page 1.12**

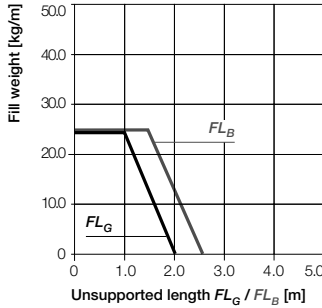
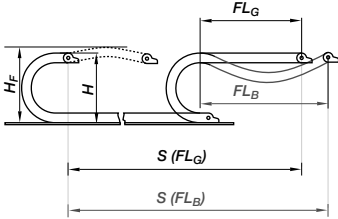

- S = Length of travel
- R = Bending radius
- H = Nominal clearance height
- H_F = Required clearance height
- D = Overlength E-Chain® radius in final position
- $K = \pi \cdot R + \text{"safety"}$

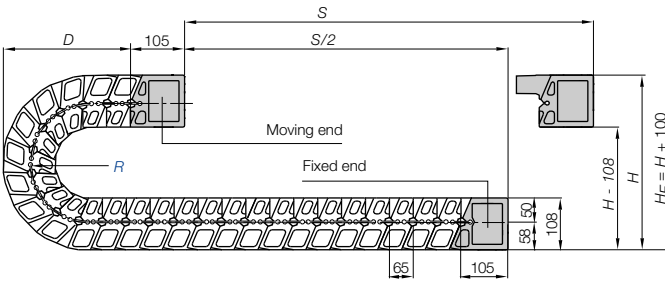

Pitch = 65 mm/link Links/m = 16 (1040 mm) Chain length = $S/2 + K$

R	175
H (min.)	466
D	298
K	680

If you intend to use this series on long travels, we request you to consult us!

Other installation methods

- Vertical, hanging ≤ 60 m
- Vertical, standing ≤ 4 m
- Side mounted, unsupported = possible to a limited extent
- Unsupported length of upper run = upon request



Short travels - unsupported

Unsupported E-Chains® feature positive camber over short travels. This must be accounted for when specifying the clearance height H_F . Please consult igus® if space is particularly restricted.

The required clearance height:
 $H_F = H + 100$ mm
 (with 5,0 kg/m fill weight)

Technical Data

Speed / acceleration FL_G	max. 20 [m/s] / max. 200 [m/s ²]
Speed / acceleration FL_B	max. 3 [m/s] / max. 6 [m/s ²]
Gliding speed / acceleration (maximum)	upon request
Material - permitted temperature °C	-40° up to +70° C
Flammability class	VDE 0304 IIC UL94 HB



Details of material properties
 ► page 1.38



System E6
 Inner height: 80 mm

Phone +49- (0) 22 03-96 49-800
 Fax +49- (0) 22 03-96 49-222



► page 8.39

For support of the lower run - **Support Tray tool kit** available ► page 9.70

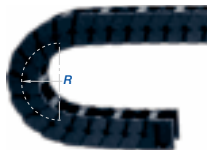
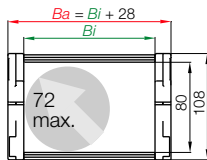
Series E6.80L - with crossbars every 2nd link

Part No.	B_j [mm]	B_a [mm]	Bending radii	Weight [kg/m]
E6.80L.11.	112	140	175	≈ 3,38
E6.80L.12.	125	153	175	≈ 3,43
E6.80L.13.	137	165	175	≈ 3,49
E6.80L.15.	150	178	175	≈ 3,55
E6.80L.16.	162	190	175	≈ 3,61
E6.80L.17.	175	203	175	≈ 3,67
E6.80L.18.	187	215	175	≈ 3,73
E6.80L.20.	200	228	175	≈ 3,79
E6.80L.21.	212	240	175	≈ 3,85
E6.80L.22.	225	253	175	≈ 3,91
E6.80L.23.	237	265	175	≈ 3,97
E6.80L.25.	250	278	175	≈ 4,02
E6.80L.26.	262	290	175	≈ 4,09
E6.80L.27.	275	303	175	≈ 4,14
E6.80L.28.	287	315	175	≈ 4,20
E6.80L.30.	300	328	175	≈ 4,26
E6.80L.31.	312	340	175	≈ 4,32
E6.80L.32.	325	353	175	≈ 4,38
E6.80L.33.	337	365	175	≈ 4,44
E6.80L.35.	350	378	175	≈ 4,50
E6.80L.36.	362	390	175	≈ 4,56
E6.80L.37.	375	403	175	≈ 4,62
E6.80L.38.	387	415	175	≈ 4,68
E6.80L.40.	400	428	175	≈ 4,74
E6.80L.41.	412	440	175	≈ 4,80
E6.80L.42.	425	453	175	≈ 4,85
E6.80L.43.	437	465	175	≈ 4,92
E6.80L.45.	450	478	175	≈ 5,03
E6.80L.46.	462	490	175	≈ 5,09
E6.80L.47.	475	503	175	≈ 5,15
E6.80L.48.	487	515	175	≈ 5,21
E6.80L.50.	500	528	175	≈ 5,27
E6.80L.51.	512	540	175	≈ 5,33
E6.80L.52.	525	553	175	≈ 5,39
E6.80L.53.	537	565	175	≈ 5,45
E6.80L.55.	550	578	175	≈ 5,51

Supplement Part No. with required radius. Example: E6.80L.15.175.0

0 = standard color, other colors ► page 1.39 · Pitch = 65 mm/link - Links/m = 16

Part No. structure

E6.80L.	15.	175.0
		Color black
		Bending radius
		Width
		Series



Part No. E-Chain® - links, single parts

Single crossbar, Part No. 450.Bi

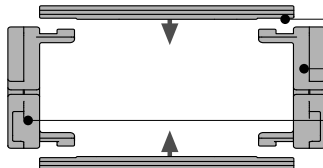

Right side link*, single part, Part No. E6.80L.02. R

Left side link*, single part, Part No. E6.80L.01. R

Polymer spring as single part -
Part No. E6.80.350

*View from the fixed point

Option 1: Vertical separators and spacers

Vertical Separators are used if a vertical subdivision of the E-Chain® interior is required -

By standard vertical separators are assembled every other E-Chain® link

- **Standard separator 511** offers safe stability due to its wide base design, even when used with large diameter cables or hoses

Also available:

- **Locking separator 514** with increased retention force for extreme applications
- The **locking separator 518** is used in applications with very high relative humidity, such as composting plants. The lateral cam serves to ensure the uniform alignment of the vertical separator (in the case of uneven alignment, the E-Chain® can only be opened by breaking the vertical separator)
- If a broad distance shall be kept between the separators or they have to be fixed in their position, e.g. in case of side mounted applications, **spacers 415.10, 415.15, 415.20, 415.30 and 415.40** can be used. Here a great number of possible distances between the vertical separators can be achieved by combining spacers of different widths with the **vertical separator, asymmetrical 511A**

Instruction: The available interior height is reduced by 2 mm per spacer, and can hence amount to 4 mm when spacers are fitted on both sides. To avoid this, the parts can also be installed from the outside on the opening crossbar. (no long travels)

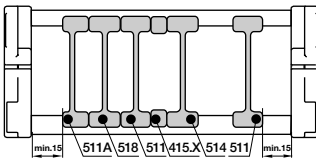

Vertical separator	
unassembled	501
assembled	511



Locking separator	
unassembled	504
assembled	514



Locking separator	
unassembled	508
assembled	518



Vert. separator, asymmetrical	
unassembled	501A
assembled	511A



Spacer*	
unassembled	405.10
assembled	415.10
unassembled	405.15
assembled	415.15
unassembled	405.20
assembled	415.20
unassembled	405.30
assembled	415.30
unassembled	405.40
assembled	415.40

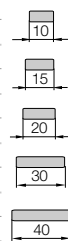

Option 2: Shelves

For applications involving many cables with similar or identical diameters. Shelves of various widths can be arranged at 11 different heights (in 7 mm increments)

- **Shelf 421.X** can be combined with **Locking vertical separator 521**, **Locking separator, slotted 517**, **middle plate 1313**, **slotted separator 515** and **slotted separator, open 519**
- **Slotted separators 515** are used for complex subdivisions. When **slotted separators, open 519** and **Locking vertical separator 521** are installed only the middle slot can be used for shelves.

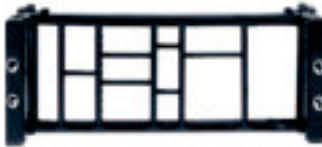
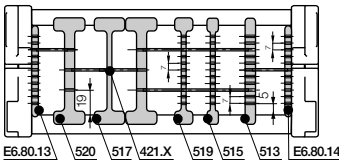

Width X [mm]	Part No. unassembled	Part No. assembled
018	420.18	421.18
023	420.23	421.23
025	420.25	421.25
028	420.28	421.28
033	420.33	421.33
043	420.43	421.43
050	420.50	421.50
062	420.62	421.62

Width X [mm]	Part No. unassembled	Part No. assembled
075	420.75	421.075
088	420.88	421.88
100	420.100	421.100
125	420.125	421.125
150	420.150	421.150
175	420.175	421.175
187	420.187	421.187
200	420.200	421.200

Locking vert. separator	
unassembled	510
assembled	520



Locking separator slotted	
unassembled	507
assembled	517



Middle plate	
unassembled	503
assembled	513



Slotted separator	
unassembled	505
assembled	515



Slotted separator, open	
unassembled	509
assembled	519



Side plate** left/right	
unassembled	E6.80.03
assembled	E6.80.13
unassembled	E6.80.04
assembled	E6.80.14



Shelf	
X = 8	
t = 4,5	



System E6
Inner height: 80 mm

Phone +49- (0) 22 03-96 49-800
Fax +49- (0) 22 03-96 49-222

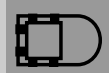



* KMA = Polymer Metal Mounting Bracket

Moving end
E6.800L...2

Option KMA* - pivoting

- Option - integrated C-profile strain relief device with Chainfix clip or strain relief tiewrap plates
- C-profile mountable in the inner or outer radius of the E-Chain®
- Bolted connection outside of chain cross-section
- Recommended for unsupported applications
- Confined installation conditions
- Universal mountable with attachment capability on all sides

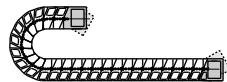

The attachment variants arising automatically by the choice of the KMA mounting bracket

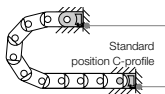

E6.800L...1
Fixed end

Dimensions and order configurations

E6.800L...2
Fixed end

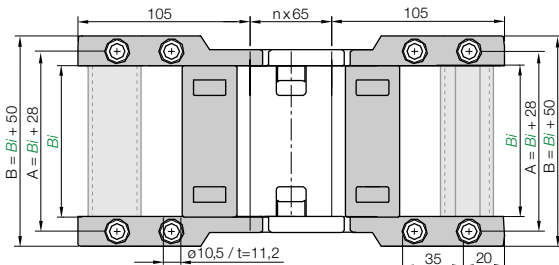

E6.800L...1
Moving end

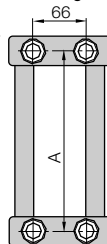

Phone +49- (0) 22 03-96 49-800
Fax +49- (0) 22 03-96 49-222

igus® GmbH
51147 Cologne

Part No. structure

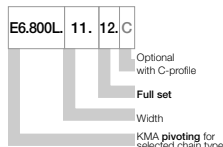

Full set, for both ends:

E6.800L. 11. 12.C (with C-profile)

Single-part order:

E6.800L. 11. 1.C (with C-profile)

Fixed end mounting bracket

E6.800L. 11. 2.C (with C-profile)

Moving end mounting bracket

For E-Chain®	Part No. full set optional with C-profile	Bi [mm]
E6.80L.11	E6.800L.11.12.C	112
E6.80L.12	E6.800L.12.12.C	125
E6.80L.13	E6.800L.13.12.C	137
E6.80L.15	E6.800L.15.12.C	150
E6.80L.16	E6.800L.16.12.C	162
E6.80L.17	E6.800L.17.12.C	175
E6.80L.18	E6.800L.18.12.C	187
E6.80L.20	E6.800L.20.12.C	200
E6.80L.21	E6.800L.21.12.C	212
E6.80L.22	E6.800L.22.12.C	225
E6.80L.23	E6.800L.23.12.C	237
E6.80L.25	E6.800L.25.12.C	250
E6.80L.26	E6.800L.26.12.C	262
E6.80L.27	E6.800L.27.12.C	275
E6.80L.28	E6.800L.28.12.C	287
E6.80L.30	E6.800L.30.12.C	300
E6.80L.31	E6.800L.31.12.C	312
E6.80L.32	E6.800L.32.12.C	325

For E-Chain®	Part No. full set optional with C-profile	Bi [mm]
E6.80L.33	E6.800L.33.12.C	337
E6.80L.35	E6.800L.35.12.C	350
E6.80L.36	E6.800L.36.12.C	362
E6.80L.37	E6.800L.37.12.C	375
E6.80L.38	E6.800L.38.12.C	387
E6.80L.40	E6.800L.40.12.C	400
E6.80L.41	E6.800L.41.12.C	412
E6.80L.42	E6.800L.42.12.C	425
E6.80L.43	E6.800L.43.12.C	437
E6.80L.45	E6.800L.45.12.C	450
E6.80L.46	E6.800L.46.12.C	462
E6.80L.47	E6.800L.47.12.C	475
E6.80L.48	E6.800L.48.12.C	487
E6.80L.50	E6.800L.50.12.C	500
E6.80L.51	E6.800L.51.12.C	512
E6.80L.52	E6.800L.52.12.C	525
E6.80L.53	E6.800L.53.12.C	537
E6.80L.55	E6.800L.55.12.C	550

Series E6.80L | Accessories | Strain Relief

Strain relief tiewrap plate can be fixed on the last crossbar, alternatively with C-profile. Tiewrap plate as individual part - Part No. 30XX.ZB. Further strain relief elements ► chapter 10



Other strain relief elements - optional ► chapter 10



Internet: www.igus.eu
E-mail: info@igus.de

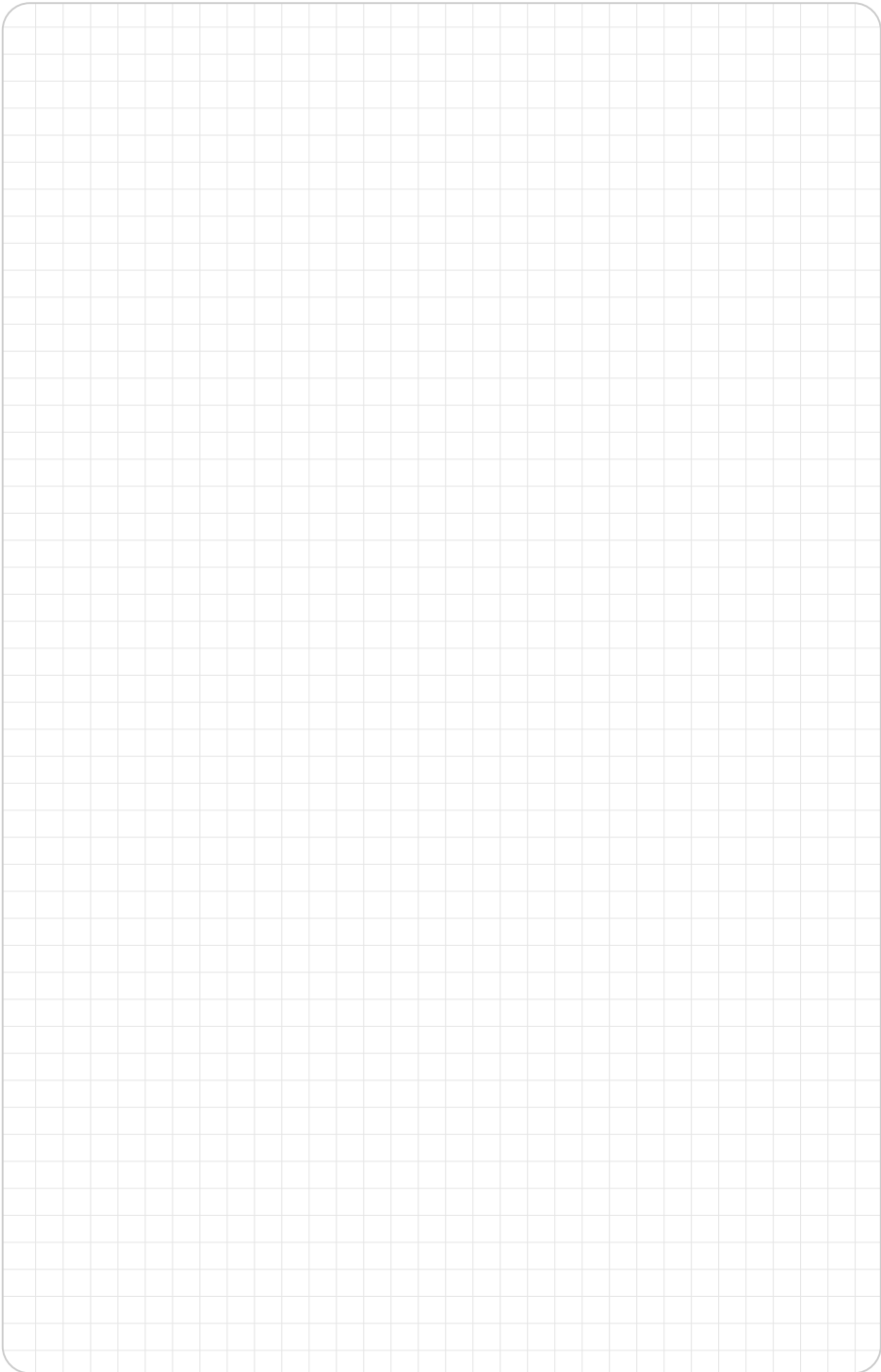

System E6
Inner height: 80 mm

Phone +49- (0) 22 03-96 49-800
Fax +49- (0) 22 03-96 49-222



► Kapitel 10



► Seite 8.39



Price index



Extremely low noise
Test results upon request



IPA certificate: Class 1, according to standard DIN EN ISO 14644-1 for the E6 system (Series E6.29.060.150.0.CR, $v = 0.5 \text{ m/s}$, $a = 1.0 \text{ m/s}^2$)



LEVEL 1 absorption confirmed by IPA-Fraunhofer-Institut according to SEMI E78-0998 for the E6 standard material



To close, push and click shut



When to use the Series E6.80:

- If a low-noise version is required
- At very high speeds and/or accelerations
- For enlarged thrusts and tensile forces
- For small bending radii
- If less vibration is required
- Minimal abrasion
(e.g. cleanroom applications)



When not to use it:

- Limited in side-mounted applications
 - ▶ Series E4.80 System E4.1, page 7.76
- No use with RBR (reverse bending radius)
 - ▶ Series E4.80 System E4.1, page 7.76
- No use with high additional loads
 - ▶ Series E4.80 System E4.1, page 7.76

- ① No pin and bore connection
- ② Interior stop dog
- ③ Small pitch for low-noise, smooth operation
- ④ Increased inner height
- ⑤ Very large gliding surfaces
- ⑥ KMA-Mounting Brackets with attachment points on all sides
- ⑦ Can be shortened or lengthened due to modular design
- ⑧ Optional with or without integrated C-profile

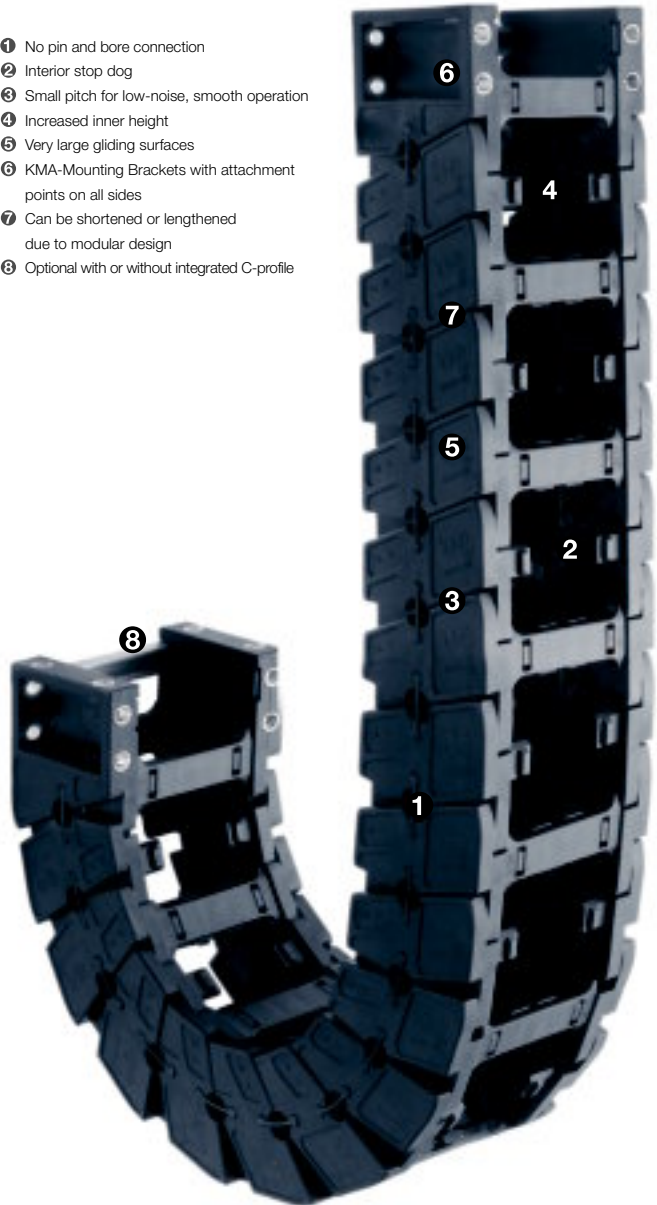

Order example complete E-Chain®

Please indicate chain-lengths or number of links Example: 5 m or 80 links

5 m **E6.80.10.200.0**

E-Chain®

with 2 separators **511** assembled every 2nd link

Interior separation

1 set **E6.800.10.12**

Mounting bracket



Unsupported length

FL_G = with straight upper run

FL_B = with permitted sag

Further information ► **Design, page 1.12**

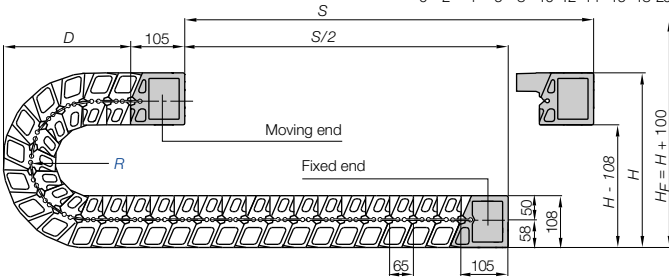
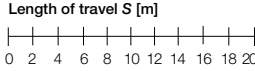
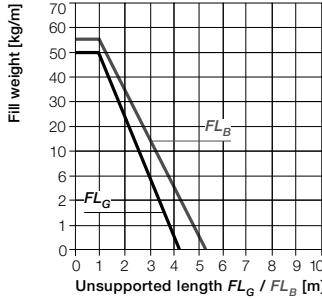
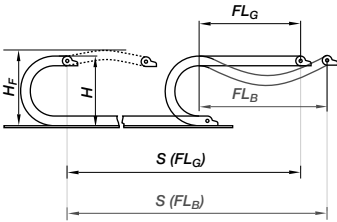

Pitch = 65 mm/link Links/m = 16 (1040 mm) Chain length = $S/2 + K$

R	150	200	250	300	350	400	450
H (min.)	416	516	616	716	816	916	1016
D	273	323	373	423	473	523	573
K	605	760	920	1075	1230	1390	1545
H ₂	242	242	242	242	242	242	242
D ₂ +25	524	936	1349	1762	2175	2588	3000
K ₂	650	1170	1690	2275	2795	3315	3835

If you intend to use this series on long travels, we request you to consult us!

Long travel lengths from 10 m to max. 120 m Chain length = $S/2 + K_2$

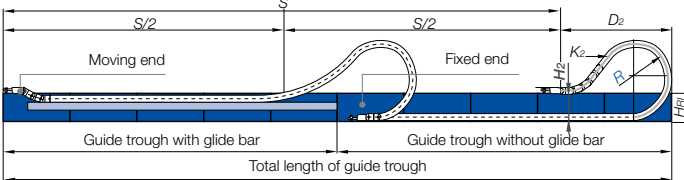

In case of travels between 4 m and 12 m we recommend a longer unsupported length.

- S = Length of travel
 - R = Bending radius
 - H = Nominal clearance height
 - H_f = Required clearance height
 - H_{RI} = Trough inner height
 - D = Overlength E-Chain® radius in final position
 - K = $\pi \cdot R$ + "safety"
 - D₂ = Over length - long travels, gliding
 - K₂ = "Further add-on"
 - H₂ = "Mounting height"
- *if the mounting bracket location is set lower

Other installation methods

- Vertical, hanging ≤ 60 m
- Vertical, standing ≤ 4 m
- Side mounted, unsupported = possible to a limited extent
- Unsupported length of upper run = upon request



Short travels - unsupported

Unsupported E-Chains® feature positive camber over short travels. This must be accounted for when specifying the clearance height H_f . Please consult igus® if space is particularly restricted.

The required clearance height:
 $H_f = H + 100$ mm
 (with 5,0 kg/m fill weight)



Gliding, long travel applications (max. 120 m)

In this case the E-Chain® upper run will be introduced in a guide trough on the lower run. We recommend to realize the engineering of such a plant by our technicians.

Technical Data

Speed / acceleration FL_G	max. 20 [m/s] / max. 200 [m/s ²]
Speed / acceleration FL_B	max. 3 [m/s] / max. 6 [m/s ²]
Gliding speed / acceleration (maximum)	upon request
permitted temperature °C	-40° up to +70° C
Flammability class	VDE 0304 IIC UL94 HB



Details of material properties

► page 1.38



System E6
Inner height: 80 mm

Phone +49- (0) 22 03-96 49-800
Fax +49- (0) 22 03-96 49-222



► page 8.39



For support of the lower run - **Support Tray tool kit** available ► page 9.70

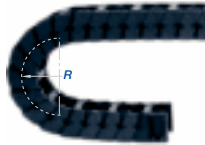
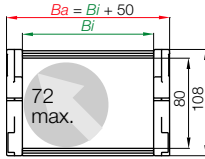

Series E6.80 - with crossbars every 2nd link

Part No.	B _I [mm]	B _A [mm]	R [mm]	Bending radii							Weight [kg/m]
E6.80.05.	50	100	150	200	250	300	350	400	450	~ 5,21	
E6.80.06.	65	115	150	200	250	300	350	400	450	~ 5,28	
E6.80.07.	75	125	150	200	250	300	350	400	450	~ 5,33	
E6.80.08.	87	137	150	200	250	300	350	400	450	~ 5,38	
E6.80.10.	100	150	150	200	250	300	350	400	450	~ 5,45	
E6.80.11.	112	162	150	200	250	300	350	400	450	~ 5,50	
E6.80.12.	125	175	150	200	250	300	350	400	450	~ 5,57	
E6.80.13.	137	187	150	200	250	300	350	400	450	~ 5,62	
E6.80.15.	150	200	150	200	250	300	350	400	450	~ 5,68	
E6.80.16.	162	212	150	200	250	300	350	400	450	~ 5,74	
E6.80.17.	175	225	150	200	250	300	350	400	450	~ 5,80	
E6.80.18.	187	237	150	200	250	300	350	400	450	~ 5,86	
E6.80.20.	200	250	150	200	250	300	350	400	450	~ 5,92	
E6.80.21.	212	262	150	200	250	300	350	400	450	~ 5,98	
E6.80.22.	225	275	150	200	250	300	350	400	450	~ 6,04	
E6.80.23.	237	287	150	200	250	300	350	400	450	~ 6,10	
E6.80.25.	250	300	150	200	250	300	350	400	450	~ 6,16	
E6.80.26.	262	312	150	200	250	300	350	400	450	~ 6,21	
E6.80.27.	275	325	150	200	250	300	350	400	450	~ 6,28	
E6.80.28.	287	337	150	200	250	300	350	400	450	~ 6,33	
E6.80.30.	300	350	150	200	250	300	350	400	450	~ 6,39	
E6.80.31.	312	362	150	200	250	300	350	400	450	~ 6,45	
E6.80.32.	325	375	150	200	250	300	350	400	450	~ 6,51	
E6.80.33.	337	387	150	200	250	300	350	400	450	~ 6,57	
E6.80.35.	350	400	150	200	250	300	350	400	450	~ 6,63	
E6.80.36.	362	412	150	200	250	300	350	400	450	~ 6,69	
E6.80.37.	375	425	150	200	250	300	350	400	450	~ 6,75	
E6.80.38.	387	437	150	200	250	300	350	400	450	~ 6,80	
E6.80.40.	400	450	150	200	250	300	350	400	450	~ 6,88	
E6.80.41.	412	462	150	200	250	300	350	400	450	~ 6,92	
E6.80.42.	425	475	150	200	250	300	350	400	450	~ 6,99	
E6.80.43.	437	487	150	200	250	300	350	400	450	~ 7,04	
E6.80.45.	450	500	150	200	250	300	350	400	450	~ 7,10	
E6.80.46.	462	512	150	200	250	300	350	400	450	~ 7,16	
E6.80.47.	475	525	150	200	250	300	350	400	450	~ 7,22	
E6.80.48.	487	537	150	200	250	300	350	400	450	~ 7,28	
E6.80.50.	500	550	150	200	250	300	350	400	450	~ 7,34	
E6.80.51.	512	562	150	200	250	300	350	400	450	~ 7,40	
E6.80.52.	525	575	150	200	250	300	350	400	450	~ 7,46	
E6.80.53.	537	587	150	200	250	300	350	400	450	~ 7,52	
E6.80.55.	550	600	150	200	250	300	350	400	450	~ 7,58	
E6.80.60.	600	650	150	200	250	300	350	400	450	~ 7,81	

Part No. structure

E6.80.10.200.0



Supplement Part No. with required radius. Example: E6.80.10.[200].0

0 = standard color, other colors ▶ page 1.39 · Pitch = 65 mm/link · Links/m = 16



Part No. E-Chain® - links, single parts



Polymer spring as single part - Part No. E6.80.350

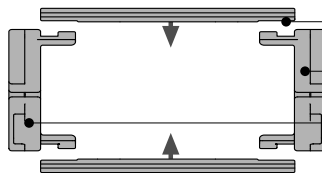

Single crossbar, Part No. 450.Bi

Right side link®, single part, Part No. E6.80.02. [R]

Left side link®, single part, Part No. E6.80.01. [R]

*View from the fixed point

Option 1: Vertical separators and spacers

Vertical separators are used if a vertical subdivision of the E-Chain® interior is required -

By standard vertical separators are assembled every other E-Chain® link

● **Standard separator 511** offers safe stability due to its wide base design, even when used with large diameter cables or hoses

Also available:

- **Locking separator 514** with increased retention force for extreme applications
- The **locking separator 518** is used in applications with very high relative humidity, such as composting plants. The lateral cam serves to ensure the uniform alignment of the vertical separator
(in the case of uneven alignment, the E-Chain® can only be opened by breaking the vertical separator)
- If a broad distance shall be kept between the separators or they have to be fixed in their position, e.g. in case of side mounted applications, **Spacers 415.10, 415.15, 415.20, 415.30 and 415.40** can be used. Here a great number of possible distances between the vertical separators can be achieved by combining spacers of different widths with the **vertical separator, asymmetrical 511A**

Instruction: The available interior height is reduced by 2 mm per spacer, and can hence amount to 4 mm when spacers are fitted on both sides. To avoid this, the parts can also be installed from the outside on the opening crossbar. (no long travels)

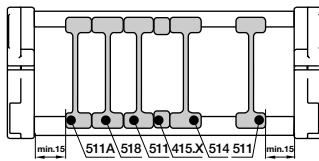

Vertical separator	
unassembled	501
assembled	511

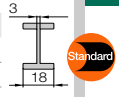

Locking separator	
unassembled	504
assembled	514



Locking separator	
unassembled	508
assembled	518



Vert. separator, asymmetrical	
unassembled	501A
assembled	511A



Spacer*	
unassembled	405.10
assembled	415.10
unassembled	405.15
assembled	415.15
unassembled	405.20
assembled	415.20
unassembled	405.30
assembled	415.30
unassembled	405.40
assembled	415.40

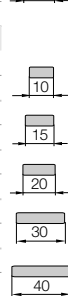

Option 2: Shelves

For applications involving many cables with similar or identical diameters. Shelves of various widths can be arranged at 11 different heights (in 7 mm increments)

- Shelf 421.X can be combined with **Locking vertical separator 521**, **Locking separator, slotted 517**, **middle plate 1313**, **slotted separator 515** and **slotted separator, open 519**
- **Slotted separators 515** are used for complex subdivisions. When **slotted separators, open 519** and **Locking vertical separator 521** are installed only the middle slot can be used for shelves

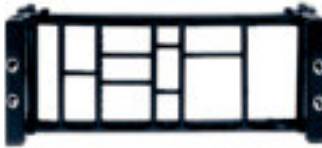
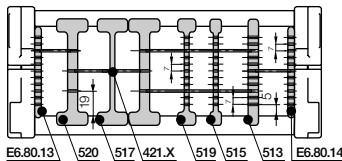

Width X [mm]	Part No. unassembled	Part No. assembled
018	420.18	421.18
023	420.23	421.23
025	420.25	421.25
028	420.28	421.28
033	420.33	421.33
043	420.43	421.43
050	420.50	421.50
062	420.62	421.62

Width X [mm]	Part No. unassembled	Part No. assembled
075	420.75	421.75
088	420.88	421.88
100	420.100	421.100
125	420.125	421.125
150	420.150	421.150
175	420.175	421.175
187	420.187	421.187
200	420.200	421.200

Locking vert. separator	
unassembled	510
assembled	520



Locking separator, slotted	
unassembled	507
assembled	517



Middle plate	
unassembled	503
assembled	513



Slotted separator	
unassembled	505
assembled	515



Slotted separator, open	
unassembled	509
assembled	519



Side plate** left/right	
unassembled	E6.80.03
assembled	E6.80.13
unassembled	E6.80.04
assembled	E6.80.14



Shelf	
width	X = 8
thickness	t = 4,5



System E6
Inner height: 80 mm

Phone +49- (0) 22 03-96 49-800
Fax +49- (0) 22 03-96 49-222

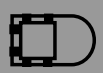

► page 8.39

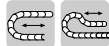

* KMA = Polymer Metal Mounting Bracket

Moving end
E6.800...2

Option KMA* - pivoting

- Option - integrated C-profile strain relief device with Chainfix clip or strain relief tiewrap plates
- C-profile mountable in the inner or outer radius of the E-Chain®
- Bolted connection outside of chain cross-section
- Recommended for unsupported and gliding applications
- Confined installation conditions
- Universal mountable with attachment capability on all sides

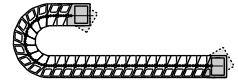

The attachment variants arising automatically by the choice of the KMA mounting bracket

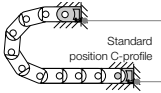

E6.800...1
Fixed end

Dimensions and order configurations



Adapters for gliding applications available upon request

E6.800...2
Fixed end

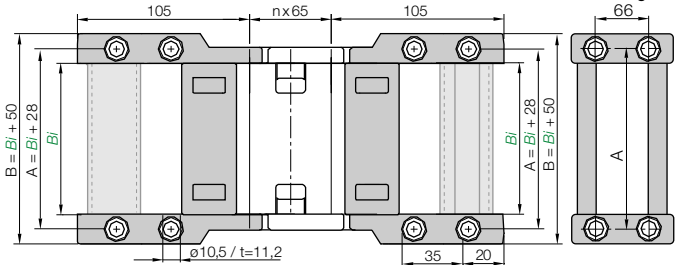

E6.800...1
Moving end

For E-Chain*	Part No. full set optional with C-profile	Bi [mm]
E6.80.05.	E6.800.05.12.C	50
E6.80.06.	E6.800.06.12.C	65
E6.80.07.	E6.800.07.12.C	75
E6.80.08.	E6.800.08.12.C	87
E6.80.10.	E6.800.10.12.C	100
E6.80.11.	E6.800.11.12.C	112
E6.80.12.	E6.800.12.12.C	125
E6.80.13.	E6.800.13.12.C	137
E6.80.15.	E6.800.15.12.C	150
E6.80.16.	E6.800.16.12.C	162
E6.80.17.	E6.800.17.12.C	175
E6.80.18.	E6.800.18.12.C	187
E6.80.20.	E6.800.20.12.C	200
E6.80.21.	E6.800.21.12.C	212
E6.80.22.	E6.800.22.12.C	225
E6.80.23.	E6.800.23.12.C	237
E6.80.25.	E6.800.25.12.C	250
E6.80.26.	E6.800.26.12.C	262
E6.80.27.	E6.800.27.12.C	275
E6.80.28.	E6.800.28.12.C	287
E6.80.30.	E6.800.30.12.C	300

For E-Chain*	Part No. full set optional with C-profile	Bi [mm]
E6.80.31.	E6.800.31.12.C	312
E6.80.32.	E6.800.32.12.C	325
E6.80.33.	E6.800.33.12.C	337
E6.80.35.	E6.800.35.12.C	350
E6.80.36.	E6.800.36.12.C	362
E6.80.37.	E6.800.37.12.C	375
E6.80.38.	E6.800.38.12.C	387
E6.80.40.	E6.800.40.12.C	400
E6.80.41.	E6.800.41.12.C	412
E6.80.42.	E6.800.42.12.C	425
E6.80.43.	E6.800.43.12.C	437
E6.80.45.	E6.800.45.12.C	450
E6.80.46.	E6.800.46.12.C	462
E6.80.47.	E6.800.47.12.C	475
E6.80.48.	E6.800.48.12.C	487
E6.80.50.	E6.800.50.12.C	500
E6.80.51.	E6.800.51.12.C	512
E6.80.52.	E6.800.52.12.C	525
E6.80.53.	E6.800.53.12.C	537
E6.80.55.	E6.800.55.12.C	550
E6.80.60.	E6.800.60.12.C	600

Phone +49- (0) 22 03-96 49-800
Fax +49- (0) 22 03-96 49-222

igus® GmbH
51147 Cologne

Part No. structure

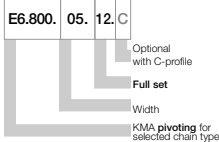

Full set, for both ends:

E6.800.05.12.C (with C-profile)

Single-part order:

E6.800.05.1.C (with C-profile)

Fixed end mounting bracket

E6.800.05.2.C (with C-profile)

Moving end mounting bracket

Series E6.80 | Accessories | Strain Relief



Other strain relief elements - optional ▶ chapter 10

Strain relief tiewrap plate can be fixed on the last crossbar, alternatively with C-profile. Tiewrap plate as individual part - Part No. 30XX.ZB. Further strain relief elements ▶ chapter 10



Internet: www.igus.eu
E-mail: info@igus.de

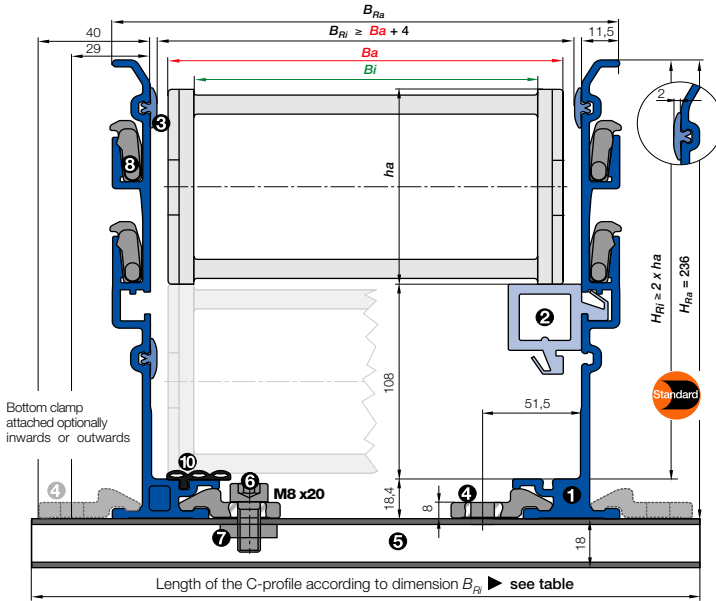

- B_a = Outer width E-Chains® / E-Tube
- B_i = Inner width E-Chains® / E-Tube
- h_a = Outer height E-Chains® / E-Tube
- H_{Ri} = Inner trough height
- H_{Ra} = Outer trough height
- B_{Ri} = Inner trough width ▶ depends on dim. B_a
- B_{Ra} = Outer trough width
- n_{Mon} = Number of installation sets (left/right)
- n_{Ri} = Number of trough sets (left/right)
- ▶ $H_{Ri} \geq 2 \cdot h_a$
- ▶ $B_{Ri} \geq B_a + 4$
- = Guide trough set ● = Glide bar
- = Installation set "Basic" ● = C-profile

Installation set "Basic" with C-profile

Bottom Clamp attached optionally inwards or outwards

E6.80.30.300.0 ▶ Order example

B_{Ri} [mm]	Part No.	
	attached inwards	attached outwards
.05	104	960.50.225
.06	119	960.50.250
.07	129	960.50.250
.08	141	960.50.200
.10	154	960.50.225
.11	167	960.50.300
.12	179	960.50.250
.13	192	960.50.250
.15	204	960.50.275
.16	217	960.50.275
.17	229	960.50.300
.18	242	960.50.300
.20	254	960.50.325
.21	267	960.50.325
.22	279	960.50.350
.23	292	960.50.350
.25	304	960.50.375
.26	317	960.50.375
.27	329	960.50.400
.28	342	960.50.400
.30	354	960.50.425
.31	367	960.50.425
.32	379	960.50.450
.33	392	960.50.450
.35	404	960.50.475
.36	417	960.50.475
.37	429	960.50.500
.38	442	960.50.500
.40	454	960.50.525
.41	467	960.50.525
.42	479	960.50.600
.43	492	960.50.550
.45	504	960.50.575
.46	517	960.50.575
.47	529	960.50.600
.48	542	960.50.600
.50	554	960.50.625
.51	567	960.50.625
.52	579	960.50.650
.53	592	960.50.650
.55	604	960.50.675
.60	654	960.50.725



- **Components, trough "Basic":** ① Trough side parts, aluminum, 2 m ② Glide bar, plastic, 2 m ③ Glide strips, plastic, 2 m (without glide strips on request) ⑩ Optional: Silencer profile, rubber
- **Components, installation set "Basic":** ④ Bottom clamp, aluminum ⑤ C-profile, steel galvanized ⑥ Screw M8 x20 ⑦ Sliding nut M8 ⑧ Interface connector, plastic

Order example: Length of travel 30 m - Center mounted for Series E6.80.30.300.0 with $B_{Ri} = 354$

- Guide trough set (set of 2 trough side parts, incl. glide strips) **without** glide bar
Order text: 16 m guide trough without glide bar (8 x 2 m sections) Part No. 975.30.SL
- Guide trough set (set of 2 trough side parts, incl. glide strips) **with** glide bar
Order text: 16 m guide trough with glide bar (8 x 2 m sections) Part No. 975.31.SL
- Installation set "Basic" complete (guide trough-sets + 1)
Order text: 17 installation sets "Basic" Part No. 960.50.425
- Module for the fixed end
Order text: 1 set Part No. 975.80
- Option:** For an additional noise dampening with silencer profile, please add Index A - Example:
Part No. 975.30.SLA

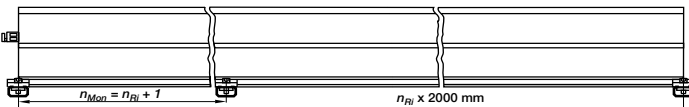

Principle sketch: Number of installation sets to be installed = Number of trough sections + 1



A quick fix for mounting the stationary end of an E-Chain®

With this module for the fixed end, fast and easy mounting onto the Aluminum "SuperTrough" is now possible without any drilling. Fast mounting of the E-Chain® by clamping onto the aluminum trough

- Quick relocation of the stationary end
- No drilling necessary ▶ page 9.16

Insert for the installation set "Heavy-Duty": **974.50.XXX** instead of **960.50.XXX** on the right column "attached outwards"

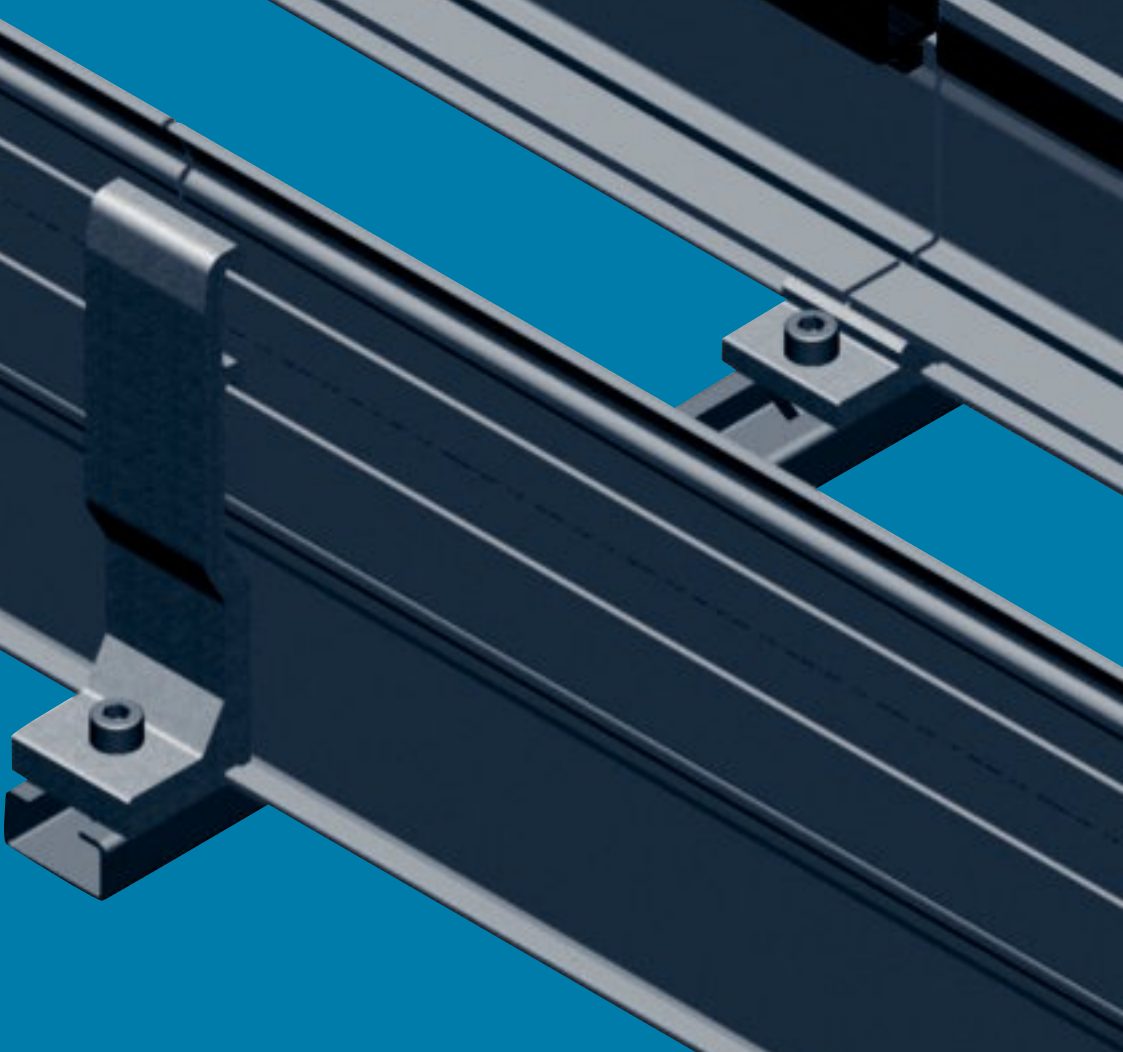

Solutions for long travel applications.

with or without Guide Troughs

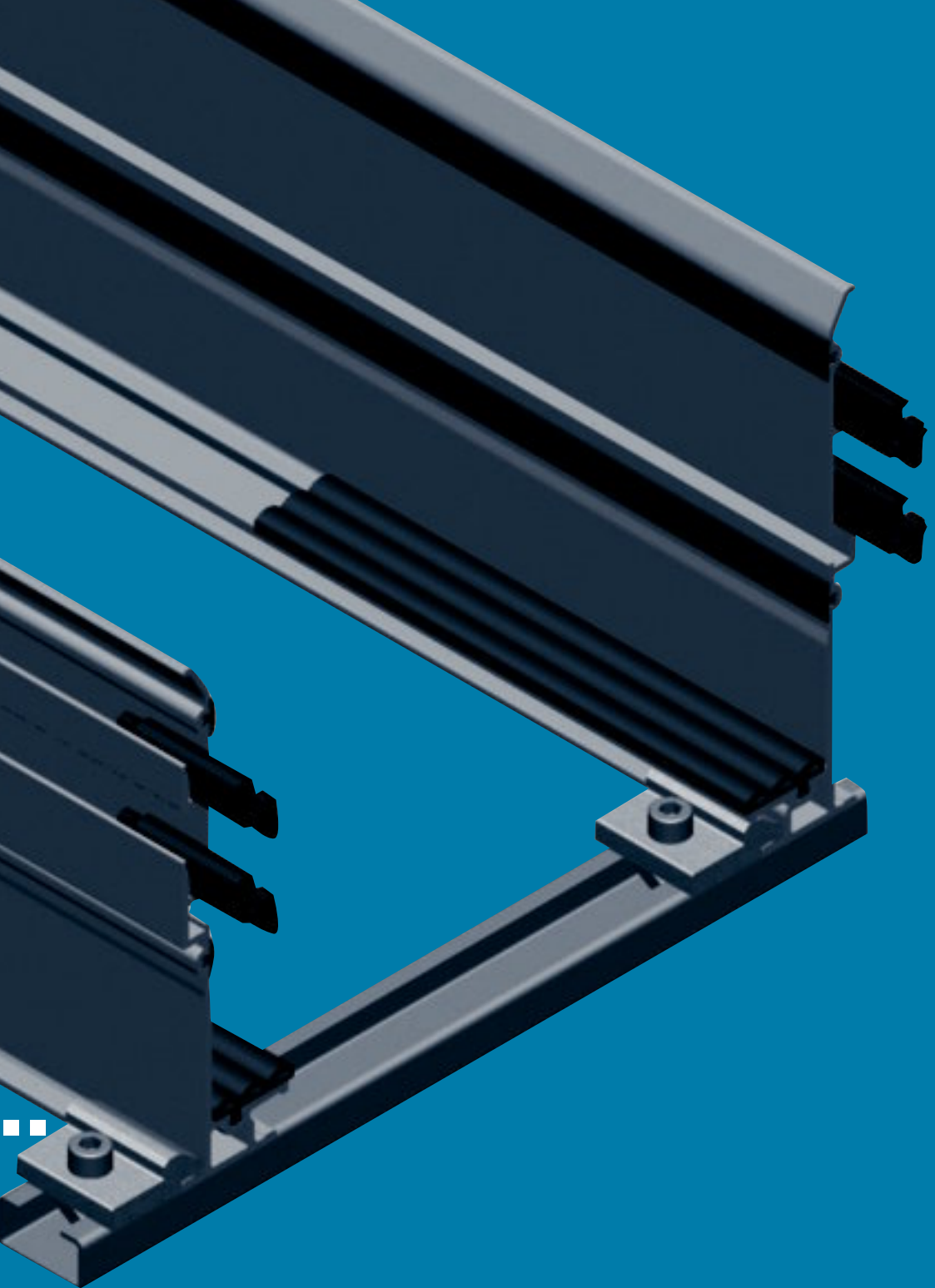

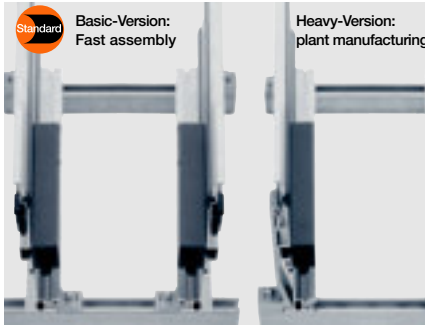

Aluminium "SuperTrough" - The igus® standard guide trough

- Very simple, modular assembly
 - Side-mounted glide strips for wear protection in high-speed
 - Corrosion resistant, seawater resistant aluminium profile
 - Flexible assembly - Fastening on substructure independent of profile lengths and butt joints
 - Plastic glide bar made of PE
 - Bottom clamp can be mounted -inside or outside- directly on the bottom or on the c-profile
 - Heavy duty brackets for safe connection also for rough applications
- ▶ from page 9.12

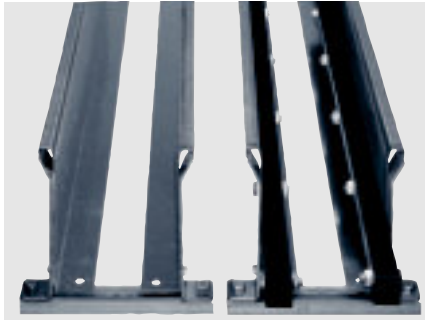

Steel guide trough - very stable and rugged for heavy duty applications

- Very stable and robust guide trough made of steel
 - Easy assembly with installation set
 - Big range, two piece design, adjustable to E-Chain® width
 - Available in galvanized steel and stainless steel
 - Glide bar made of PE
- ▶ from page 9.42

Further Guide Troughs | Cost-effective troughs and support trays

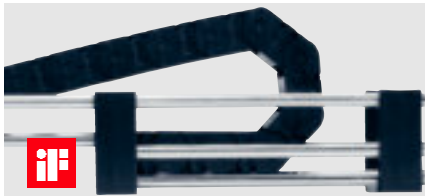

Tubular trough system RS - lets light and dirt through

- Resistant to dirt - wear debris falls through
 - More translucent than sheet metal constructions
 - Easy and fast assembly and low price
 - Easy and space saving delivery
- ▶ from page 9.66



Snap-in trough system SP - simple and cost effective

- Smaller than conventional troughs
 - Easy and fast assembly
 - No sharp metal edges in the internal area because of covered connectors
 - Low price because of easy assembly
- ▶ from page 9.68



For support of the lower run - Support tray tool kit

- Complete system, ready to install
 - No more costly self-made designs
 - Easy installation onto your machine, on profiles or wall-mount brackets
- ▶ from page 9.70



System P4 - Rol E-Chain®

800 m travels and more are possible and speed (up to 10 m/s), silent

- Smooth, shock free motion, running offset with split rollers
 - Energy efficiency system for long travels
- ▶ from page 9.78



Rol E-Chain® - Rolling instead of gliding

Travels up to 800 m, speeds up to 6 m/s

- Major reduction in drive power to less than 25 % for moving the E-Chain®
 - Rol E-Chain® is designed for applications with long travel lengths at high speed
- ▶ from page 9.86



AUTO-GLIDE - Long travels without guide troughs

Travels up to 50 m, speeds up to 1,5 m/s

- AUTO-GLIDE E-Chain® links are moulded and no additional parts are necessary
 - Very fast assembly times for long travels - No Guide Troughs required!
- ▶ from page 9.90



Guidelok horizontal - upper run guide for long travels

Travels, unsupported up to 50 m possible

- Chips cannot get stuck between upper and lower run
 - Enormous increase of „self supporting“ length of E-Chains®
- ▶ from page 9.96



Guidelok vertical - for safe vertical guidance

For vertical applications with lateral motion

- Keeps hanging E-Chains® in line - no swinging sideways
 - No bouncing of E-Chains® in vertical applications with horizontal dynamics
- ▶ from page 9.98



LBT Flizz® - Enclosed plastic trough

Travels up to 200 m, speeds up to 8 m/s

- Applicable for moving and stationary control, ideal for all bus systems
 - Good for applications needing low weight and good corrosion resistance
- ▶ from page 9.100



Micro Flizz® - Small E-Chains® in aluminum profile

ONE compact system for a secure guidance of power, data and air

- Maintenance-free alternative for busbar
 - Control via stationary switch cabinet possible
- ▶ from page 9.104





LeviChain - magnetic E-ChainSystem® - it "floats"

Long travel possible without laying the E-Chain® systems on top of each other

- Almost no abrasion and very low wear due to low-abrasion E-Chain® links (without pin/bore connection) as well as almost contactless movement of the E-Chain®
- ▶ from page 9.112

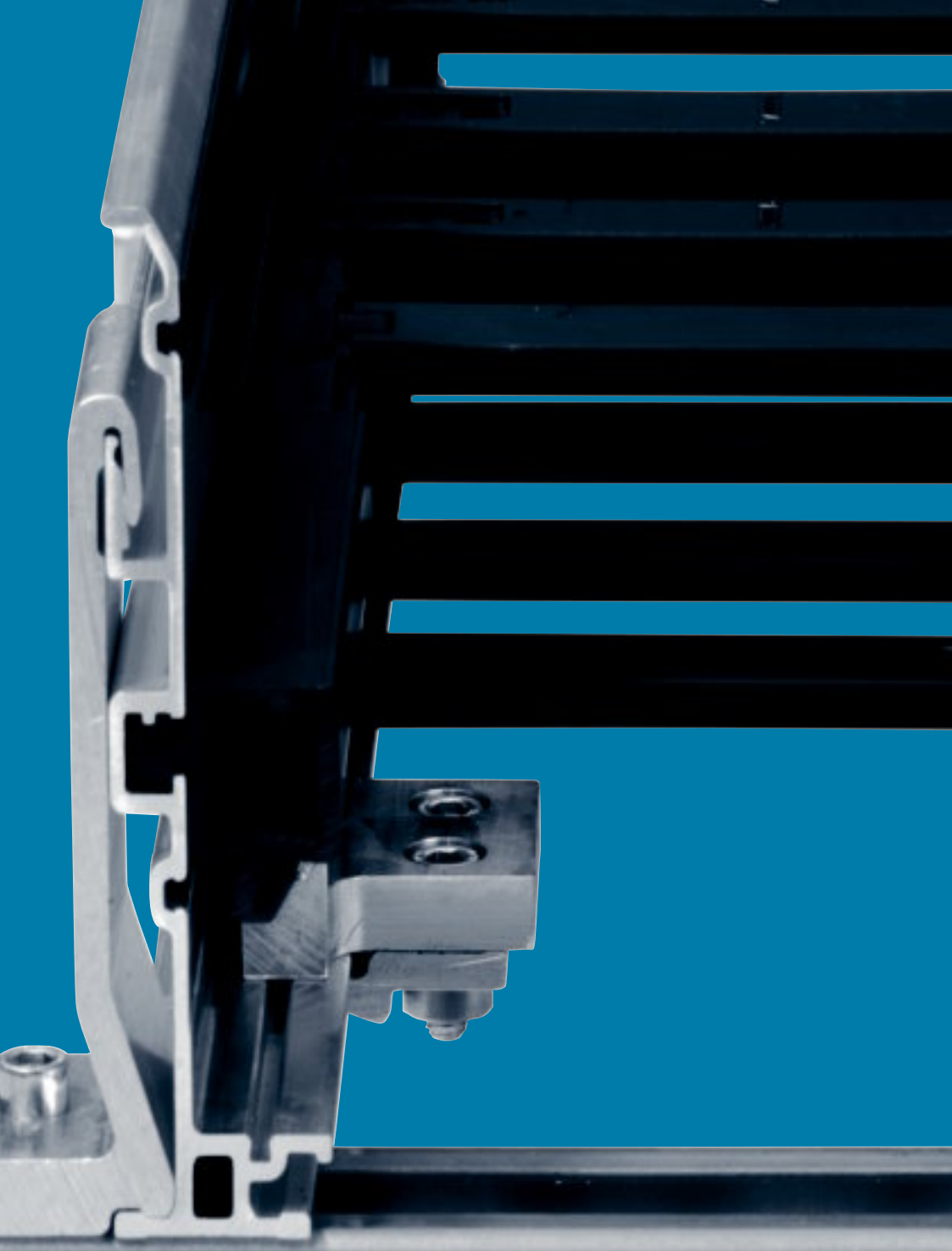



A detailed cross-sectional view of a Guide Trough System. The image shows a complex assembly of metal components. On the left, a dark, perforated metal plate is visible. In the center, a large, light-colored metal profile with a complex, multi-chambered internal structure is shown. To the right of this profile, a smaller metal component with two circular holes is attached. At the bottom right, a cylindrical metal fastener is visible. The entire assembly is set against a solid blue background.

Guide Trough Systems

Aluminum "SuperTrough" | Basic version - for general machinery



AL Basic version
 ▶ from page 9.20

Guide trough Series Part No.	Outer trough height H_{Ra} [mm]	Price index	Materials of side parts	Page
970.30.SL / 970.31.SL	77	● ● ●	Aluminum	9.20
970.30.SL / 970.32.SL	77	● ● ●	Aluminum	9.22
971.30.SL / 971.31.SL	87	● ● ●	Aluminum	9.24
972.02.30.SL / 972.02.31.SL	117	● ● ●	Aluminum	9.26
972.30.SL / 972.31.SL	117	● ● ●	Aluminum	9.28
972.30.SL / 972.32.SL	117	● ● ●	Aluminum	9.30
973.30.SL / 973.31.SL	144	● ● ●	Aluminum	9.32
974.30.SL / 974.31.SL	184	● ● ●	Aluminum	9.34
975.30.SL / 975.31.SL	236	● ● ●	Aluminum	9.38

Assembly kit for the basic version

The basic assembly kits are the standard for the super aluminum troughs. They can be fastened inside or outside and are recommended for most application areas. The basic clamping shoes are made of aluminum. The part numbers of the basic assembly kits can be found on the corresponding Super-Alu-Trough page.

Aluminum "SuperTrough" | Heavy-duty version - for rugged plant construction

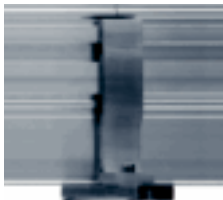

AL Heavy-Duty Version
 ▶ fom page 9.24

Guide trough Series Part No.	Outer trough height H_{Ra} [mm]	Price index	Materials of side parts	Page
971.30.SL / 971.31.SL	87	● ● ●	Aluminum	9.24
972.02.30.SL / 972.02.31.SL	117	● ● ●	Aluminum	9.26
972.30.SL / 972.31.SL	117	● ● ●	Aluminum	9.28
972.30.SL / 972.32.SL	117	● ● ●	Aluminum	9.30
973.30.SL / 973.31.SL	144	● ● ●	Aluminum	9.32
974.30.SL / 974.31.SL	184	● ● ●	Aluminum	9.36
975.30.SL / 975.31.SL	236	● ● ●	Aluminum	9.40

Assembly kit for the heavy-duty version

The heavy-duty version of the Super-Alu-Trough is differentiated only by the type of the assembly kit. The part numbers of the channel side plates, slide bars, etc., are the same as the basic model. The heavy-duty assembly kit consists of a rugged aluminum bracket, fastened outside on the guide trough. The heavy-duty assembly kits are recommended for plant construction and extreme application areas. The part numbers of these assembly kits can be found on the corresponding Super-Alu-Trough page.

Steel guide troughs | For harsh environments



ST Steel guide troughs
▶ from page 9.44

Guide trough Series Part No.	Outer trough height H_{Ra} [mm]	Price index	Materials of side parts	Page
92.30 / 92.31	70	● ● ●	Galvanized steel*	9.44
95.30 / 95.31	100	● ● ●	Galvanized steel*	9.46
99.30 / 99.31	100	● ● ●	Galvanized steel*	9.48
97.30 / 97.31	130	● ● ●	Galvanized steel*	9.50
93.30 / 93.31	130	● ● ●	Galvanized steel*	9.52
94.30 / 94.31	170	● ● ●	Galvanized steel*	9.54
96.30 / 96.31	220	● ● ●	Galvanized steel*	9.56
98.30 / 98.31	300	● ● ●	Galvanized steel*	9.58
90.30 / 90.31	480	● ● ●	Galvanized steel*	9.60
91.10 - 91.71**	48	● ● ●	Galvanized steel*	9.63

*Stainless steel on request **Steel guide troughs, one-piece

Tubular trough system RS | Lets debris through, and gives good visibility

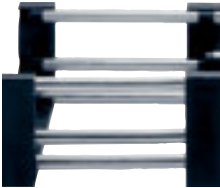

RS Tubular trough
▶ from page 9.66

Guide trough Series Part No.	Outer trough height H_{Ra} [mm]	Price index	Materials of side parts	Page
92.70 / 92.71	90	● ● ●	Galvanized steel / Polymer	9.66
93.70 / 93.71	146	● ● ●	Galvanized steel / Polymer	9.67
95.70 / 95.71	126,3	● ● ●	Galvanized steel / Polymer	9.67

Snap-in trough system SP | Simple and cost effective



SP Snap-in trough
▶ from page 9.68

Guide trough Series Part No.	Outer trough height H_{Ra} [mm]	Price index	Materials of side parts	Page
91.930	55,5	● ● ●	Galvanized steel	9.68
92.930	76,6	● ● ●	Galvanized steel	9.68
93.930	138,6	● ● ●	Galvanized steel	9.69
95.930	106,6	● ● ●	Galvanized steel	9.69

Support tray | For support of the lower run



Support tray
▶ from page 9.70

Support tray Part No.	E-Chain* width	Inner trough - width B_{Ri} [mm]	Outer trough - width B_{Ro} [mm]	Material	Page
S9.010/011.05.XXXX.0	.05 / .050	89	80	Steel, black	9.70
S9.010/011.07.XXXX.0	.07 / .070	114	105	Steel, black	9.70
S9.010/011.10.XXXX.0	.10 / .100	139	130	Steel, black	9.70
S9.010/011.15.XXXX.0	.15 / .150	185	175	Steel, black	9.70
S9.020/021.10.XXXX.0	.10 / .100	167	156	Steel, black	9.70
S9.020/021.15.XXXX.0	.15 / .150	217	206	Steel, black	9.70
S9.020/021.20.XXXX.0	.20 / .200	267	256	Steel, black	9.70
S9.020/021.25.XXXX.0	.25 / .250	317	306	Steel, black	9.70

XXXX = length 1000 or 2000 mm - for almost every Series E2/000, E4.1 and E6 E-Chains* available

igus® guide troughs

Guide troughs are used for long travels, (travels from 5 to 12 m) and greater, depending on the E-Chain® type. They allow to continue smooth, low-friction operation in these long-travel situations. If the E-Chains® are installed in the center of the travel ("center-mounted"), they glide on themselves for half the travel. For the other half, we recommend glide bars, which are assembled in the trough and on which the E-Chains® glide. igus® guide troughs are available from stock with these highly abrasion-resistant polymer glide bars, which perform well with igus® E-Chains® regarding noise, abrasion and friction.



Various guide trough systems are available



New in this catalog: igus® Support tray - for support of the lower run ► page 9.70

Trough type

igus® offers guide troughs made of corrosion-resistant aluminum, steel, stainless steel, as well as tubes and insert troughs (with steel side plates). The trough type to be used depends on the application conditions and the requirements of the customer. We recommend the igus® standard super aluminum guide troughs.

Glide bars

Glide bars made of igulen are optimally matched to the E-Chain® material and achieve the lowest values for friction, noise and wear. Glide bars must be used, if the fixed point is in the center of the travel. It means: Use half of the guide trough with glide bars and the other half of the guide trough without glide bars.

Delivery condition

The troughs are delivered in 2 meter sections. Special lengths up to 6 m are possible. The left and right side parts are installed on location with the appropriate distance - depending on the width of the E-Chain®. The necessary width is shown by the dimension B_{PI} on the guide trough pages. The E-Chain® sides can be linked with the base through screwing, welding or a special igus® installation set. The fixation module for the igus® Super-Alu-Trough is a quick fix for mounting the stationary end of an E-Chain® with a KMA-mounting bracket. With this module a fast and easy mounting onto the Super-Aluminum-Trough is possible without any drilling ► page 9.16.

Own production

The dimensions quoted in this chapter are for design and installation. They apply exclusively to igus® guide trough systems. If a user of igus® E-Chains® produces own designs, the manufacturing and installation dimensions for the necessary guide trough must be obtained from igus®. This applies in particular to the use of one-piece guide troughs and the play between guide trough and E-Chain®, depending on chain type, chain length, size bending radius and tolerance of the moving end and the base. One must be particularly careful here, since a function-compatible setting during installation and a subsequent adjustment is not possible for such guide troughs.



Trough without glide bars - E-Chain® glides on E-Chain®



Trough with glide bars - E-Chain® glides on glide bars



Center mounted: 1/2 Travel with glide bars - 1/2 Travel without glide bars

For long travels, the upper run of the igus® E-Chains® rests on the lower run. The upper run glides partially on the lower run and partially at the same height on a glide bar. The diagrams below show this. For lateral guidance, a Guide Trough is necessary. If the stationary mounting bracket and the fixed end of the cables and hoses can be placed **in the center**, the E-Chain® length is calculated as follows: $L_k = S/2 + K$. The shortest E-Chain® length is attained by the axial feeder module. The length of the E-Chain® then corresponds to about half the travel distance. Depending on the technical data and the selected E-Chain®, the mounting point of the moving end of the E-Chain® must be lowered on some units. In our system analysis for long travels, we give exact details for your specific application.

Selection criteria

Following parameters are required for the design of a trough system:
 ● E-Chain® type (Series, width Bi, radius R) ● Travel and travel speed
 ● Fill weight ● Acceleration and/or lagging ● Lateral accelerations ● Environmental conditions

Design and installation of the guide trough

The guide trough is an important element in long travel applications. Usually, the height of the trough must be at least twice that of the E-Chain® link height: $H_{Ri} \geq 2 \times ha$. The sides must provide a chamfered opening. The trough inner width is the same as the E-Chain® outer width, plus 5 mm ($B_{Ri} = Ba + 4$). Along the side of the trough, where the upper run cannot glide on the lower run, glide bars must be installed. We recommend the use of polymer glide bars from igus®. They are optimally matched to the E-Chain® material and achieve the lowest values for friction, noise and wear. Guide troughs with and without glide bars can

S	= Length of travel
R	= Bending radius
H_F	= Required clearance height
K₂	= Further add-on (if the mounting bracket location is set lower)
K	= $\pi \cdot R$ + "safety" Add-on for bending radius (K is taken from the data tables of the individual igus® Series)
D₂	= Over length for long travels gliding
Ba	= Outer E-Chain® width
Bi	= Inner E-Chain® width
ha	= Outer E-Chain® height
H_{Ri}	= Inner trough height
H_{Ra}	= Outer trough height
H₂	= Mounting height (if the mounting bracket location is set lower)
B_{Ri}	= Inner E-Chain® width ► depending on Ba
B_{Ra}	= Guide trough outer width
L_k	= E-Chain® length
$L_k = S/2 + K_2$ $H_{Ri} \geq 2 \times ha$ $B_{Ri} \geq Ba + 4$	
	Guide trough
	Installation set "Basic"
	Glide bar
	C-profile

be obtained for almost all igus® E-Chains®. **Important: When assembling the trough parts, the following points must be given particular attention:** ● Properly align all trough parts upon installation ● All screw heads should be flush with the trough ● Smooth levelled transition between the end of the E-Chain® and the glide bars ● Solid connection with the glide surface. **These points must be observed when using assembly-friendly igus® guide troughs.**

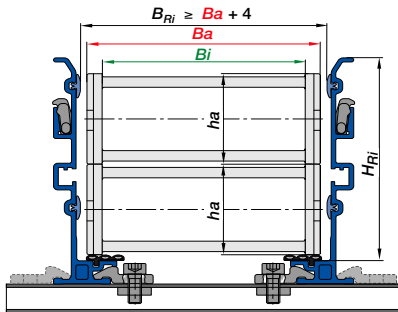

Guide troughs without glide bars - upper run glides on the lower run

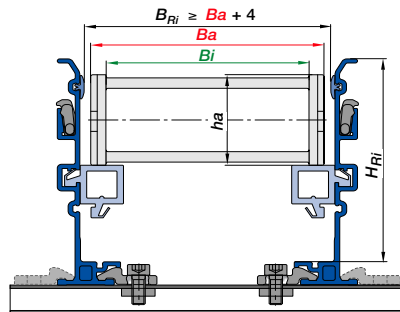

Guide troughs with glide bars - From the middle of the travel the upper run glides off on the glide bar

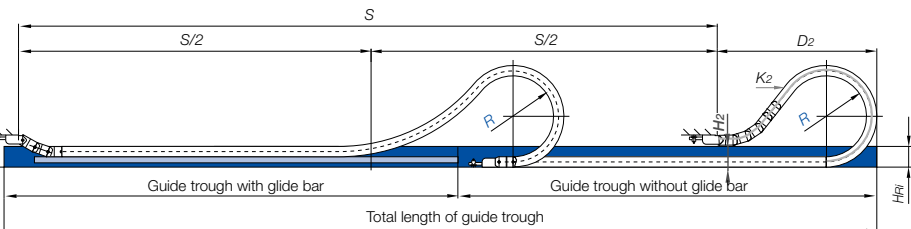

The function of an E-ChainSystem® for gliding applications

The fixed end of the E-Chain® is located in the center of the travel distance

Selected guide trough Series	Type	Part No. Aluminium SuperTrough	Optional noise dampening	Optional Heavy Duty	Part No. fixed end module ► page 9.16
10/B15.015	E2 mini	970.30.SL, 970.31.SL	–	–	970.80
10/B15.025	E2 mini	970.30.SL, 970.31.SL	–	–	970.80
10/B15.038	E2 mini	970.30.SL, 970.31.SL	–	–	970.80
10/B15.050	E2 mini	970.30.SL, 970.31.SL	–	–	970.80
10/B15.5	E2 mini	970.30.SL, 970.31.SL	–	–	970.80
10/B15.6	E2 mini	970.30.SL, 970.31.SL	–	–	970.80
10/B15.7	E2 mini	970.30.SL, 970.31.SL	–	–	970.80
15.015	Zipper	970.30.SL, 970.31.SL	–	–	970.80
15.025	Zipper	970.30.SL, 970.31.SL	–	–	970.80
15.038	Zipper	970.30.SL, 970.31.SL	–	–	970.80
15.050	Zipper	970.30.SL, 970.31.SL	–	–	970.80
15.5	Zipper	970.30.SL, 970.31.SL	–	–	970.80
15.6	Zipper	970.30.SL, 970.31.SL	–	–	970.80
15.7	Zipper	970.30.SL, 970.31.SL	–	–	970.80
1500	E2/000	970.30.SL, 970.32.SL	–	–	970.80
2500	E2/000	971.30.SL, 971.31.SL	●	●	971.80
2700	E2/000	972.30.SL, 972.32.SL	●	●	972.81
3500	E2/000	973.30.SL, 973.31.SL	●	●	973.80
250	E2 medium	971.30.SL, 971.31.SL	●	●	–
255	E2 medium	971.30.SL, 971.31.SL	●	●	–
27	E2 medium	972.30.SL, 972.32.SL	●	●	–
350	E2 medium	973.30.SL, 973.31.SL	●	●	–
R48	E2 R	971.30.SL, 971.31.SL	●	●	–
R58	E2 R	972.30.SL, 972.32.SL	●	●	–
R68	E2 R	973.30.SL, 973.31.SL	●	●	–
E4.21 (210)	E4.1	970.30.SL, 970.32.SL	–	–	–
E4.28/R4.28	E4.1	972.02.30.SL, 972.02.31.SL	●	●	972.82
E4.32/H4.32/R4.32	E4.1	972.30.SL, 972.31.SL	●	●	972.80
E4.42/H4.42/R4.42	E4.1	973.30.SL, 973.31.SL	●	●	973.81
E4.56/H4.56/R4.56	E4.1	974.30.SL, 974.31.SL	●	●	974.80
E4.80/H4.80/R4.80	E4.1	975.30.SL, 975.31.SL	●	●	975.80
220/R760	E4/00	972.02.30.SL, 972.02.31.SL	●	●	972.82
280/290/R770	E4/00	972.30.SL, 972.31.SL	●	●	972.80
380/390/R780	E4/00	973.30.SL, 973.31.SL	●	●	973.81
400/410/R880	E4/00	974.30.SL, 974.31.SL	●	●	974.80
2828/2928/R7728	E4/4	972.30.SL, 972.31.SL	●	●	972.80
3838/3938/R7838	E4/4	973.30.SL, 973.31.SL	●	●	973.81
4040/4140/R8840	E4/4	974.30.SL, 974.31.SL	●	●	974.80
4040HD/R8840HD	E4/4	974.30.SL, 974.31.SL	●	●	–
5050/5150/R9850	E4/4	975.30.SL, 975.31.SL	●	●	975.80
5050HD/R9850HD	E4/4	975.30.SL, 975.31.SL	●	●	–
14040/14140/R18840	E4/light	974.30.SL, 974.31.SL	●	●	974.81
14240/14340	E4/light	974.30.SL, 974.31.SL	●	●	974.81
15050/15150/R19850	E4/light	975.30.SL, 975.31.SL	●	●	975.81
E6.29/R6.29	E6	971.30.SL, 971.31.SL	●	●	–
E6.35	E6	972.02.30.SL, 972.02.31.SL	●	●	972.82
E6.40/R6.40	E6	972.30.SL, 972.31.SL	●	●	972.80
E6.52/R6.52	E6	973.30.SL, 973.31.SL	●	●	973.81
E6.62	E6	974.30.SL, 974.31.SL	●	●	974.80
E6.80	E6	975.30.SL, 975.31.SL	●	●	975.80

● as option possible – not possible

A quick fix for mounting the stationary end of an E-Chain®

With this module for the fixed end, fast and easy mounting onto the Aluminium "SuperTrough" is now possible without any drilling. Fast mounting of the E-Chain® by clamping onto the aluminium trough ● Quick relocation of the stationary end ● No drilling necessary

Selected guide trough Series	Type	Part No. Steel guide troughs	Part No. Tubular troughs	Part No. Snap-in troughs	Availability Support tray
10/B15.015	E2 mini	91.10, 91.11**	-	91.930	-
10/B15.025	E2 mini	91.20, 91.21**	-	91.930	-
10/B15.038	E2 mini	91.30, 91.31**	-	91.930	-
10/B15.050	E2 mini	91.40, 91.41**	-	91.930	-
10/B15.5	E2 mini	91.50, 91.51**	-	91.930	-
10/B15.6	E2 mini	91.50, 91.51**	-	91.930	-
10/B15.7	E2 mini	91.50, 91.51**	-	91.930	-
15.015	Zipper	91.10, 91.11**	-	91.930	-
15.025	Zipper	91.20, 91.21**	-	91.930	-
15.038	Zipper	91.30, 91.31**	-	91.930	-
15.050	Zipper	91.40, 91.41**	-	91.930	-
15.5	Zipper	91.50, 91.51**	-	91.930	-
15.6	Zipper	91.50, 91.51**	-	91.930	-
15.7	Zipper	91.50, 91.51**	-	91.930	-
1500	E2/000	92.30, 92.31*	92.70, 92.71	92.930	●
2500	E2/000	92.30, 92.31*	92.70, 92.71	92.930	●
2700	E2/000	95.30, 95.31*	95.70, 95.71	95.930	●
3500	E2/000	93.30, 93.31*	93.70, 93.71	93.930	●
250	E2 medium	92.30, 92.31*	92.70, 92.71	92.930	●
255	E2 medium	92.30, 92.31*	92.70, 92.71	-	●
27	E2 medium	95.30, 95.31*	95.70, 95.71	95.930	●
350	E2 medium	93.30, 93.31*	93.70, 93.71	93.930	●
R58	E2 R	95.30, 95.31*	-	-	-
R68	E2 R	93.30, 93.31*	-	-	-
E4.21 (210)	E4.1	-	-	-	●
E4.28/R4.28	E4.1	99.30, 99.31*	-	-	●
E4.32/H4.32/R4.32	E4.1	97.30, 97.31*	-	-	●
E4.42/H4.42/R4.42	E4.1	93.30, 93.31*	-	-	●
E4.56/H4.56/R4.56	E4.1	94.30, 94.31*	-	-	●
E4.80/H4.80/R4.80	E4.1	96.30, 96.31*	-	-	●
1640/1608	E4.1	98.30, 98.31*	-	-	●
800/840	E4.1	90.30, 90.31*	-	-	-
220/R760	E4/00	99.30, 99.31*	-	-	●
280/290/R770	E4/00	97.30, 97.31*	-	-	●
380/390/R780	E4/00	93.30, 93.31*	-	-	●
400/410/R880	E4/00	94.30, 94.31*	-	-	●
600/601/R608	E4/00	98.30, 98.31*	-	-	-
640	E4/00	98.30, 98.31*	-	-	-
2828/2928/R7728	E4/4	97.30, 97.31*	-	-	●
3838/3938/R7838	E4/4	93.30, 93.31*	-	-	●
4040/4140/R8840	E4/4	94.30, 94.31*	-	-	●
4040HD/R8840HD	E4/4	94.30, 94.31*	-	-	-
5050/5150/R9850	E4/4	96.30, 96.31*	-	-	●
5050HD/R9850HD	E4/4	96.30, 96.31*	-	-	●
14040/14140/R18840	E4/light	94.30, 94.31*	-	-	●
14240/14340	E4/light	94.30, 94.31*	-	-	●
15050/15150/R19850	E4/light	96.30, 96.31*	-	-	●
E6.29/R6.29	E6	92.30, 92.31*	92.70, 92.71	92.930	●
E6.35	E6	99.30, 99.31*	-	-	●
E6.40/R6.40	E6	97.30, 97.31*	-	-	●
E6.52/R6.52	E6	93.30, 93.31*	93.70, 93.71	93.930	●
E6.62	E6	94.30, 94.31*	-	-	●
E6.80	E6	96.30, 96.31*	-	-	●

● Available *Stainless steel on request **Steel guide troughs, one-piece

A detailed cross-sectional view of a window frame assembly. The central vertical element is a dark grey or black frame profile. To its right is a grey aluminum frame section with a complex internal profile. This section includes a cylindrical roller at the top, a curved track for the roller, and a vertical channel. Two silver-colored metal nuts are visible, one at the top and one at the bottom, which appear to secure the assembly. The background is a solid blue color.

Alu Super Trough



**Aluminium "SuperTrough" -
The igus® standard guide trough**

- Modular design in two versions - Basic and Heavy Duty
- Very simple, modular assembly
- Side-mounted glide strips for wear protection in high-speed
- Corrosion resistant, seawater resistant aluminium profile
- Flexible assembly - Fastening on substructure independent of profile lengths and butt joints
- Interface connector - Plastic with snap-in connection
- Plastic glide bar made of PE
- Bottom clamp can be mounted -inside or outside- directly on the bottom or on the c-profile
- Glide strips and silencer profile for the minimization of the noise level
- Heavy duty brackets for safe connection also for rough applications
- C-profile for the fixation of the bottom clamp or Heavy duty brackets
- Fixed end module for fast and easy mounting onto the Aluminium "SuperTrough" - without any drilling

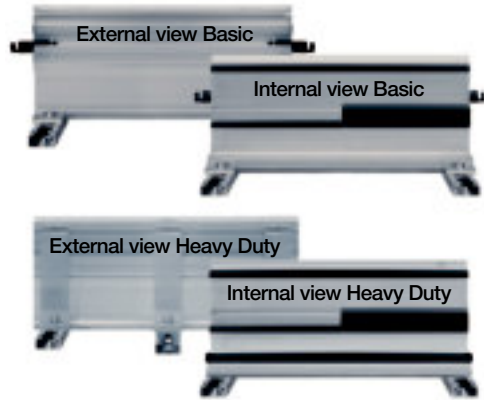

Aluminium "SuperTrough" is available in low cost "basic versions" and can be upgraded for heavy duty applications

Aluminium "SuperTrough" - Overview of sizes

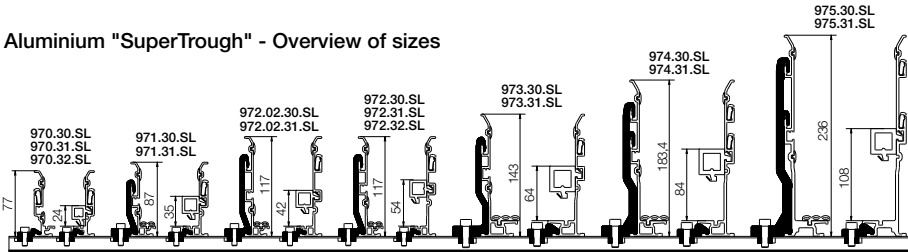

Super-Alu trough configuration according to your requirements

Assemble the right trough suited for your application quickly and easily

- Selection of the suitable guide trough according to the E-Chain® Series and E-Chain® width *B_i* ► **page 9.10**
 - Determine the feeding point of the cables ► **page 9.9**
 - Determine travel distance and thus the length of the required guide trough and the number of trough pieces. (Standard length of a trough side plate: 2000 mm). The length of the guide trough - for axial feeding - is calculated from half the travel length **with** and half the travel length **without** the glide bar
 - Option: "Sound dampening" with silencer profile ► **page 9.15**
 - Number and selection of the assembly kit ► **page 9.14/9.15:**
There are two assembly kit options: Basic (standard), Heavy Duty (for plant construction)
- The quantity of the assembly kit is calculated from the number of the trough pieces + 1 kit:**

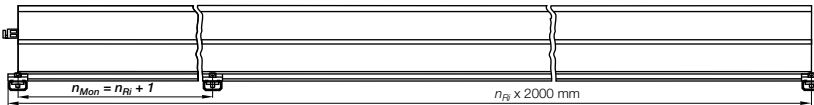

- Selection of the fastening of the assembly kit on the subsurface - igus® C rails option
- If you have opted for an E-Chain® with KMA mounting brackets, we offer you a fixed-end module for the quick and simple fastening of the E-Chain® in the trough without holes ► **page 9.16**

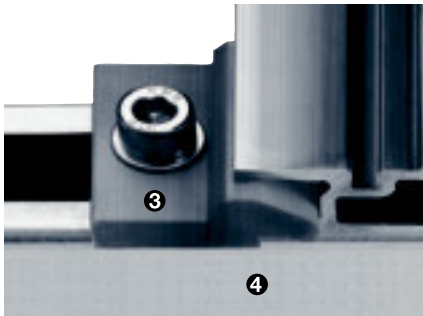
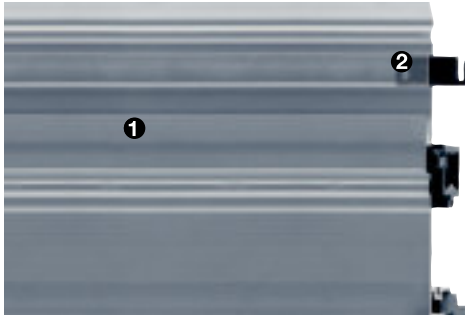
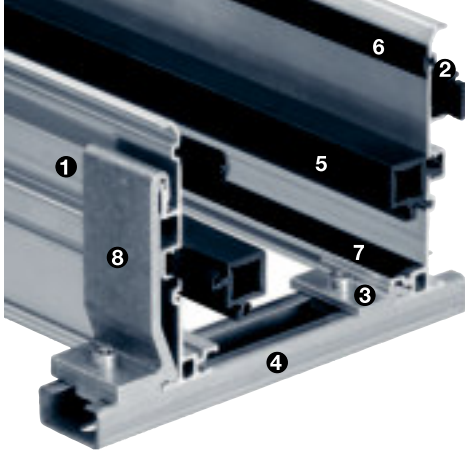

Aluminium "SuperTrough" | Advantages

Aluminum "Super Trough"- the igus® standard

The Aluminum "SuperTrough" is a modular guide trough system for long travels (when E-Chains® glide on themselves). Aluminum "SuperTrough" is available in low cost "basic versions" and can be upgraded for heavy duty applications. **This modular usage makes it the igus® recommended standard trough system.**

Huge program

- ① Aluminium profile (Standard: 2 m section)
 - Fitted to the igus® E-Chain® program
 - For almost all igus® E-Chains® available
 - Seawater resistant and corrosion resistant

Fast connection

- ② Interface connector "Basic"
 - Snap-on polymer connector
 - Easy assembly, no tools needed
 - Simply clipped on firmly in the provided slot

Simple fastening

- ③ Bottom clamp "Basic"
 - Fast and easy single-bolt assembly
 - Slider attached inwards or outwards, directly to the ground or onto a C-profile
 - Standard assembly kit for igus® Super-Alu troughs
 - Ideal for general mechanical engineering
- ④ C-profile
 - Hold Bottom clamps or heavy duty brackets
 - Available in zinc-plated or stainless steel

Misalignment-free installation

- Screwing or welding of the profiles not required
- Manifold fastening potentials with bracket, clamping shoe and connectors
- Flexible fastening on substructure independent of profile lengths and butt joints
- No screw heads sticking out inwards
- Even change-over between E-Chain® connection and glide bar

Wear-reducing

⑤ Polymer glide bar

- Easy click-on assembly (tongue and groove), no tools needed
- Even support due to the special slot design
- Glide bars are ideally suited for the E-Chain® material
- Minimum coefficients in terms of friction noise and wear

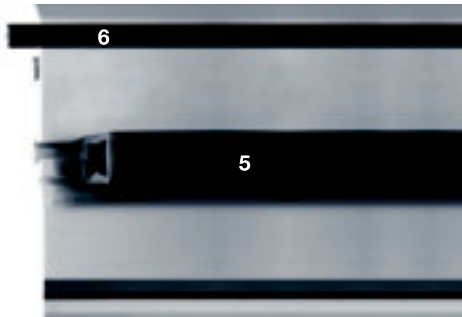

⑥ Glide strip

- Protect from wear on the sides
- Easy click-on assembly (tongue and groove), no tools needed

Noise-reducing

⑦ Silencer profile (add-on item)

- Rubber profile insert for additional noise reduction
- Excellent wear and sound values when applied with igus® E-Chain® systems: In combination with optimized igus® roller E-Chain® and "dampening profile" of the Super-Alu trough, a distinct reduction in noise reduction of 9.0 dB (A) is evident
- Can be optionally ordered

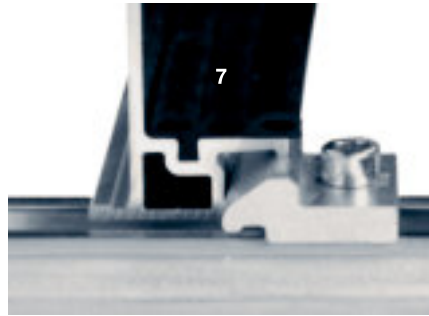

Heavy stress

⑧ Heavy duty bracket (add-on item)

- Safe grip for heavy duty operation
- Easy tongue and groove assembly
- Attached directly to ground or to C-profiles
- Can be optionally ordered

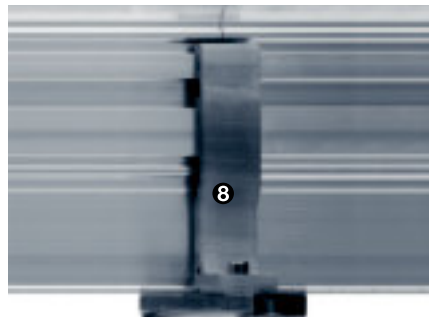

Simple connection to the E-Chain®

⑨ Fixed end module

- Quick assistance while fastening of the E-Chain® fixed end on the Super-Alu trough
- Fixed end module for fast and easy mounting onto the Aluminium "SuperTrough" - without any drilling
- Can be optionally ordered - Recommended for E-Chain® with KMA mounting bracket in conjunction with igus® Super-Alu trough

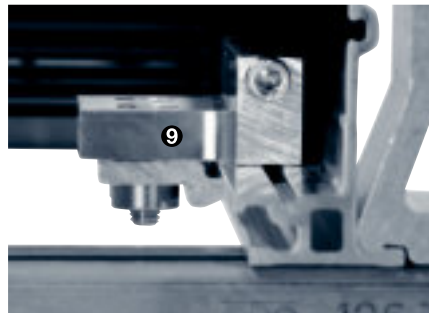



A quick fix for mounting the stationary end of an E-Chain®

With this module for the fixed end, fast and easy mounting onto the Alu "SuperTrough" is now possible without any drilling. Fast mounting of the E-Chain® by clamping onto the alu trough ● Quick relocation of the stationary end ● No drilling necessary

Installation - A) Fixed-end module, B) KMA mounting bracket

- ① Removing the preassembled metal bushings
- ② Use of threaded bushings
- ③ Installation fixed-end module
- ④ Mounting on Super-Alu trough

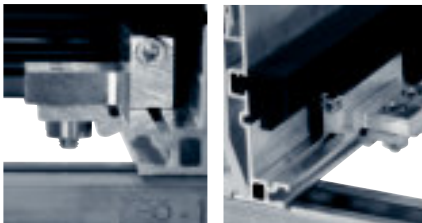
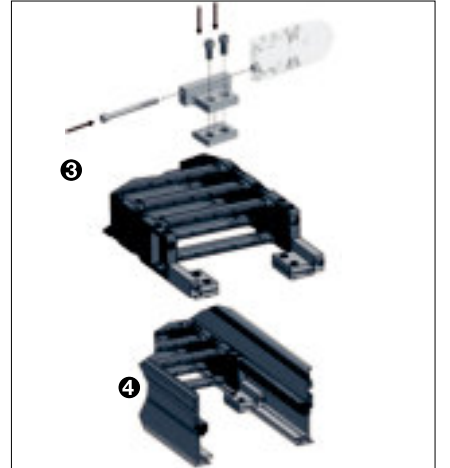
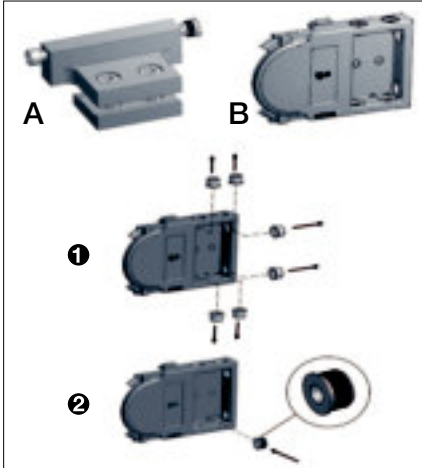

Fixed-end module - Simple fastening of the E-Chain® without drilling

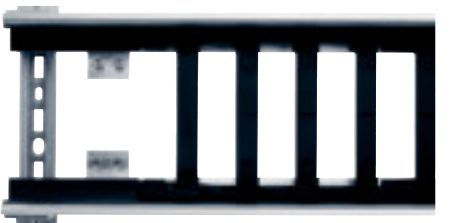

Part No.	For Aluminum-SuperTrough	For Series	Application including Inner width (B)	Mounting Bracket
970.80	970.30.SL / 970.31.SL	10, B15, 15/R15, 1500	.025	one-piece
971.80	971.30.SL / 971.31.SL	2500	.07	KMA
972.82	972.02.30.SL / 972.02.31.SL	E4.28/R4.28, 220/R760, E6.35	.06	KMA
972.81	972.30.SL / 972.32.SL	2700	.06	KMA
972.80	972.30.SL / 972.31.SL	E4.32/H4.32/R4.32, 280/290/R770, 282B/292B/R772B, E6.40/P6.40	.06	KMA
973.81	973.30.SL / 973.31.SL	E4.42/H4.42/R4.42, 380/390/R780, 383B/393B/R783B, E6.52/P6.52	.10	KMA
973.80	973.30.SL / 973.31.SL	3500	.100	KMA
974.81	974.30.SL / 974.31.SL	14040/14140/R18840, 14240/14340	.10	KMA
974.80	974.30.SL / 974.31.SL	E4.56/H4.56/R4.56, 400/410/R880, 4040/4140/R8840, E6.62	.10	KMA
975.80	975.30.SL / 975.31.SL	E4.80/H4.80/R4.80, 5050/5150/R9850, E6.80	.10	KMA
975.81	975.30.SL / 975.31.SL	15050/15150/R19850	.10	

Material assembly kits: Aluminum AlMg3, seawater resistant. Material screw kits: Standard steel, galvanized. Also available in stainless steel 1.4571 as an option: e.g. 974.80.E4



The igus® Super-Alu trough has been used in test setups since 2005.

Test setup "Axis 1": Speed 1.5 m/s, Travel: 18 m, Mileage so far: about 50,000 km (test runs since 2005)



Test - Glide strips minimize wear after 1.653.187 cycles, 4.300 km

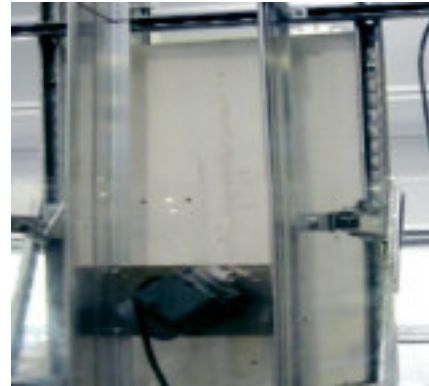

Vibration test: No shifting of trough sections after 108.000.000 rotations at 658 rpm.

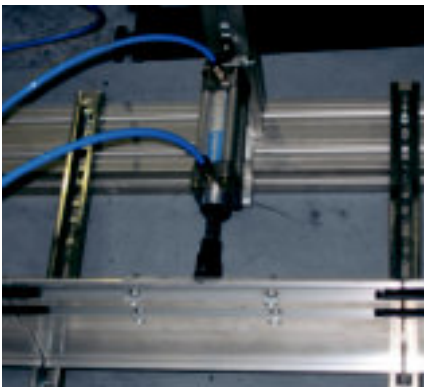

Test - Interface connector

- Push/pull force of 350N
- 9.890.000 cycles without shifting of the connector

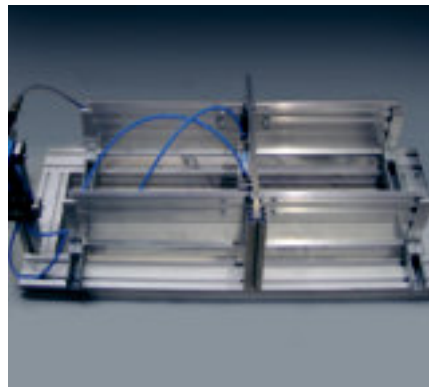

Alternating push- and pull force of 400N is induced on 2 trough side parts, with no deformation after 1.700.000 cycles

Phone +49- (0) 22 03-96 49-800
Fax +49- (0) 22 03-96 49-222



Installation sets | Basic and Heavy Duty

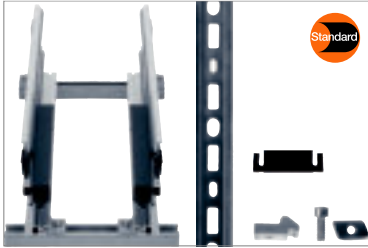

Installation set Basic

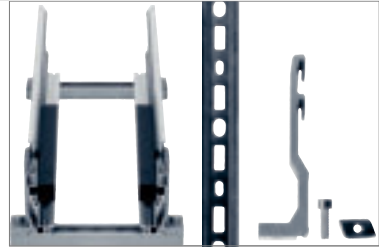

Installation set Heavy Duty

Pre-assembly of installation set | Basic - The Standard!



Pre-assemble the clamping shoe and the screw kit

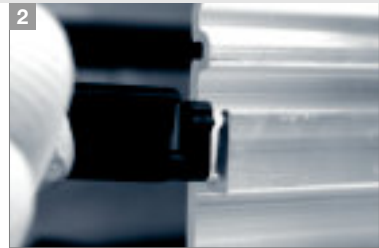

Clip in polymer connector on both sides of the designated support

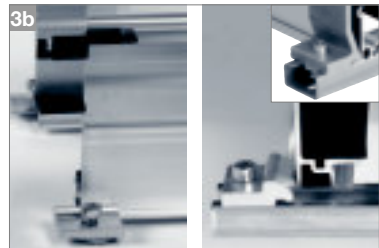

Fasten Basic assembly set Basic inside ③a or outside ③b (Check stability of the fixing). Please note: half the length of the assembly set and connector must protrude out of the trough. The glide nut should be well fastened in the C-profile

Pre-assembly of installation set | Heavy Duty (alternative)



① Pre-assemble heavy duty bracket and screw set ② Fasten Heavy Duty assembly set outside. Please note: half the length of the assembly set and connector must protrude out of the trough





Cut the rubber profile in accordance to the length of the trough (standard 2 m) and press it into the designated groove. (Pictured: Left and right sides are the same. To be repeated for each trough section.)

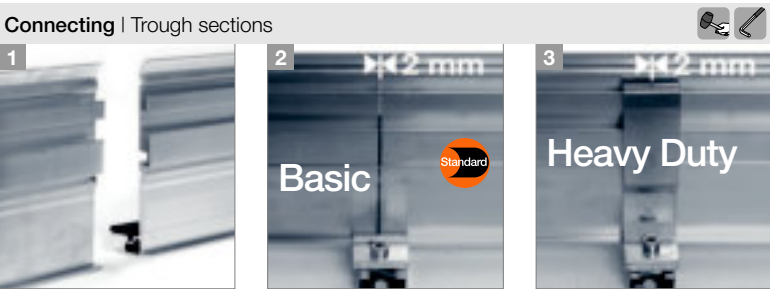

- 1 Join the sides of the trough side parts by pushing them together (min. +2 mm gap!)
- 2 + 3 The pre-assembled parts join each trough section centrally



- 1 Adjust by the necessary minimum "E-Chain"/trough" tolerance of 2 mm on both sides. Please note: the inner width B_{pi} of the trough decreases 2 mm per side with the assembled glide strip (pictured)
- 2 Test to ensure the E-Chain runs problem free and with low friction in the channel
- 3 After adjusting the minimum tolerance and alignment of all trough sections, please pull tight all screw tight all trough connections. Pay attention thereby to the correct installation direction of the sliding nut (see detail) Starting torque of the assembly set's fixing bolts: M6: 10 Nm / M8: 23 Nm.

Tools for the assembling of the SuperTrough

- Pictogram aid: Hand
- Pictogram aid: Rubber hammer
- Pictogram aid: Hexagonal wrench
- Pictogram aid: Ruler

! Please consider health & safety regulations while handling sheet metals. We recommend using protective Category II gloves to protect against cuts when handling the aluminium profiles.





For the following
E-Chains®/E-Tubes:

System E2 Series

- 10
- B15
- Zipper Series
- 15/R15

B_a = Outer E-Chain® width
 B_i = Inner E-Chain® width
 h_a = E-Chain® outer height
 H_{Ri} = Inner trough height
 H_{Ra} = Outer trough height
 B_{Ri} = Inner trough width ▶
 depends on dim. B_a
 B_{Ra} = Outer trough width

! $H_{Ri} \geq 2 \cdot h_a$
 $B_{Ri} \geq B_a + 4$

- = Guide trough
- = Glide bar
- = Installation set "Basic"
- = C-profile

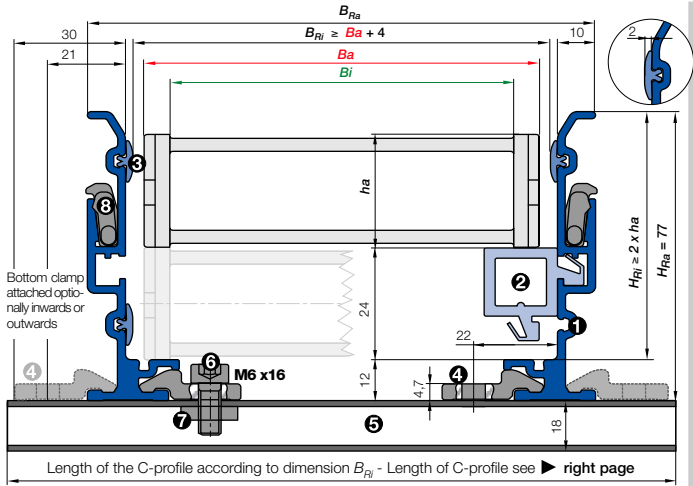

- **Components, trough "Basic":** ① Trough side parts, aluminum, 2 m ② Glide bar, plastic, 2 m ③ Glide strips, plastic, 2 m (without glide strips on request)
- **Components, installation set "Basic":** ④ Bottom clamp, aluminum ⑤ C-profile, steel galvanized ⑥ Screw M6 x 16 ⑦ Sliding nut M6 ⑧ Interface connector, plastic

Basic version: Aluminum "SuperTrough" components

Complete guide trough sets - description	Part No.	Weight	kg
① Set of 2 trough side parts, incl. glide strips, without glide bars, 2 m section	970.30.SL	= 4,20 kg	
① Set of 2 trough side parts, incl. glide strips, with glide bars, 2 m section	970.31.SL	= 4,90 kg	
1 Installation set "Basic" without C-profile	960.30	= 0,06 kg	
1 Installation set "Basic" with C-profile	960.30.		
Single parts - description			
⑥ 1 Glide strip, individual, 2 m section	75.01	= 0,06 kg	
④ 1 Bottom clamp, individual	75.40	= 0,03 kg	
⑧ 1 Interface connector, individual	75.60		
⑥ 1 Screw M6 x 16, individual	MAT 0040209		
⑦ 1 Sliding nut M6, individual	MAT 0040057		
② 1 Glide bar, individual, 2 m section	82.79	= 0,42 kg	
⑤ 1 C-profile, individual	92.52.	= 0,90 kg/m	

Phone +49- (0) 22 03-96 49-800
 Fax +49- (0) 22 03-96 49-222

igus® GmbH
 51147 Cologne



Calculation - travel center mounted

Half travel length, rounded down to full 2 m sections = X m guide trough length without glide bars + X m guide trough length with glide bars + installation sets "Basic" (number of trough pieces + 1)

Supplement Part No. with the indicated C-profile-length-index.
Example: 960.30.125
 C-profile length-index for your chosen trough inner width B_{Ri} ▶ see table on the right or the respective page for chosen series



Fixed end module - A quick fix for mounting the stationary end of an E-Chain® ▶ page 9.16



Order example: Length of travel 30 m - Center mounted for Series 10.5.038.0 with $B_{Ri} = 80$

Guide trough set (set of 2 trough side parts, incl. glide strips) **without** glide bar
Order text: 16 m guide trough without glide bar (8 x 2 m sections) Part No. 970.30.SL

Guide trough set (set of 2 trough side parts, incl. glide strips) **with** glide bar
Order text: 16 m guide trough with glide bar (8 x 2 m sections) Part No. 970.31.SL

Installation set "Basic" complete (guide trough-sets + 1)
Order text: 17 installation sets "Basic" Part No. 960.30.125

Module for the fixed end
Order text: 1 set Part No. 970.80

Option: For an additional noise dampening with silencer profile, please add Index A Example: Part No. 970.30.SLA

Internet: www.igus.eu
 E-mail: info@igus.de

Lengths of C-profile for Basic version - Bottom clamp attached optionally **inwards** or **outwards**

10			B15			15			R15		
10.5.038.0			B15.5.038.0			15.5.038.0			R15.025.100.0		
B_{Ri} [mm]	Part No. attached inwards	Part No. attached outwards	B_{Ri} [mm]	Part No. attached inwards	Part No. attached outwards	B_{Ri} [mm]	Part No. attached inwards	Part No. attached outwards	B_{Ri} [mm]	Part No. attached inwards	Part No. attached outwards
.015	30	*	960.30.125	.015	30	*	960.30.125	.015	30	*	960.30.125
.025	40	*	960.30.150	.025	40	*	960.30.150	.025	40	*	960.30.150
.038	53	*	960.30.150	.038	53	*	960.30.150	.038	53	*	960.30.150
.050	65	960.30.125	960.30.175	.050	65	960.30.125	960.30.175	.050	65	960.30.125	960.30.175
.5	80	960.30.125	960.30.175	.5	80	960.30.125	960.30.175	.5	80	960.30.125	960.30.175
.6	98	960.30.150	960.30.200	.6	98	960.30.150	960.30.200	.6	98	960.30.150	960.30.200
.7	117	960.30.175	960.30.225	.7	117	960.30.175	960.30.225	.7	117	960.30.175	960.30.225

*upon request

Lengths of C-profile for Basic version - Bottom clamp attached optionally **inwards** or **outwards**

1500

1500.050.035.0

B_{Ri} [mm]	Part No. attached inwards	Part No. attached outwards
.015 33	*	960.30.125
.020 38	*	960.30.125
.025 43	*	960.30.150
.038 56	*	960.30.150
.050 68	960.30.125	960.30.175
.068 86	960.30.150	960.30.175
.080 98	960.30.150	960.30.200
.100 118	960.30.175	960.30.225
.125 143	960.30.200	960.30.250

E4.21 (210)

E4.21.080.100.0

B_{Ri} [mm]	Part No. attached inwards	Part No. attached outwards
.030 48	*	960.30.150
.040 58	960.30.125	960.30.150
.050 68	960.30.125	960.30.175
.060 78	960.30.125	960.30.175
.070 88	960.30.150	960.30.175
.080 98	960.30.150	960.30.200
.100 118	960.30.175	960.30.225
.120 138	960.30.200	960.30.225

*upon request



For the following
E-Chains®/E-Tubes:

System E2 Series

- 2500

- 255

System E2 E-Tubes

- R48

System E6 Series

- E6.29/R6.29

E2 medium classic

- 250 classic

B_a = Outer E-Chain® width
 B_i = Inner E-Chain® width
 h_a = E-Chain® outer height
 H_{Ri} = Inner trough height
 H_{Ra} = Outer trough height
 B_{Ri} = Inner trough width
depends on dim. B_a
 B_{Ra} = Outer trough width

! $H_{Ri} \geq 2 \cdot h_a$
■ $B_{Ri} \geq B_a + 4$

● = Guide trough

● = Glide bar

● = Installation set "Basic"

● = C-profile



Calculation - travel center mounted

Half travel length, rounded down to full 2 m sections = X m guide trough length without glide bars + X m guide trough length with glide bars + installation sets "Basic" (number of trough pieces + 1)

Supplement Part No. with the indicated C-profile-length-index.

Example: 960.30.150

C-profile length-index for your chosen trough inner width B_{Ri} ▶ see table on the right or the respective page for chosen series



Fixed end module - A quick fix for mounting the stationary end of an E-Chain® ▶ page 9.16

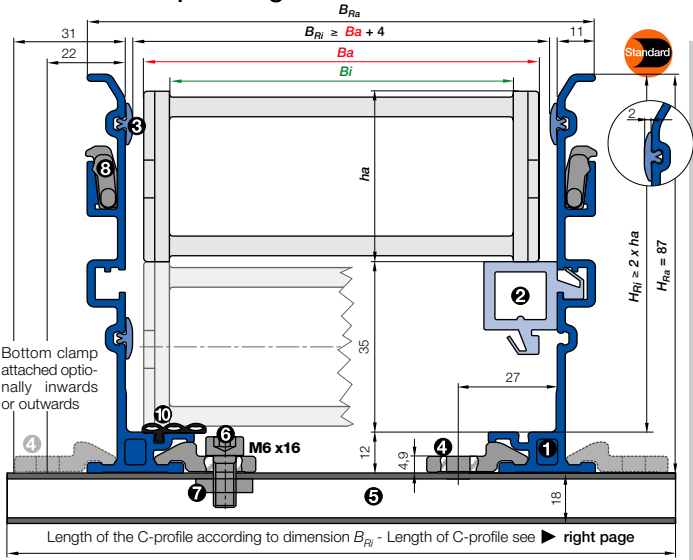

- **Components, trough "Basic":** ① Trough side parts, aluminum, 2 m ② Glide bar, plastic, 2 m ③ Glide strips, plastic, 2 m (without glide strips on request) ⑩ Optional: Silencer profile, rubber
- **Components, installation set "Basic":** ④ Bottom clamp, aluminum ⑤ C-profile, steel galvanized ⑥ Screw M6 x 16 ⑦ Sliding nut M6 ⑧ Interface connector, plastic

Basic version: Aluminum "SuperTrough" components

Complete guide trough sets - description	Part No.	Weight	kg
① Set of 2 trough side parts, incl. glide strips, without glide bars, 2 m section	971.30.SL	≈ 5,00 kg	
① Set of 2 trough side parts, incl. glide strips, with glide bars, 2 m section	971.31.SL	≈ 6,40 kg	
1 Installation set "Basic" without C-profile	960.30	≈ 0,06 kg	
1 Installation set "Basic" with C-profile	960.30.		
Single parts - description			
⑥ 1 Glide strip, individual, 2 m section	75.01	≈ 0,06 kg	
⑩ 1 Silencer profile, rubber, individual, 2 m section	75.67.H		
④ 1 Bottom clamp, individual	75.40	≈ 0,03 kg	
⑧ 1 Interface connector, individual	75.60		
⑥ 1 Screw M6 x 16, individual	MAT 0040209		
⑦ 1 Sliding nut M6, individual	MAT 0040057		
② 1 Glide bar, individual, 2 m section	82.79	≈ 0,60 kg	
⑤ 1 C-profile, individual	92.52.	≈ 0,90 kg/m	



Order example: Length of travel 30 m - Center mounted for Series 2500.07.200.0 with $B_{Ri} = 97$

Guide trough set (set of 2 trough side parts, incl. glide strips) **without** glide bar
Order text: 16 m guide trough without glide bar (8 x 2 m sections) Part No. 971.30.SL

Guide trough set (set of 2 trough side parts, incl. glide strips) **with** glide bar
Order text: 16 m guide trough with glide bar (8 x 2 m sections) Part No. 971.31.SL

Installation set "Basic" complete (guide trough-sets + 1)
Order text: 17 installation sets "Basic" Part No. 960.30.150

Module for the fixed end
Order text: 1 set Part No. 971.80

Option: For an additional noise dampening with silencer profile, please add Index A Example:
Part No. 971.30.SLA

Lengths of C-profile for Basic version - Bottom clamp attached optionally inwards or outwards

2500			255			E6.29/R6.29			R48		
2500.02.200.0			255.03.200.0			E6.29.030.100.0			48.050.100.0		
B_{Ri} [mm]	Part No. attached inwards	Part No. attached outwards	B_{Ri} [mm]	Part No. attached inwards	Part No. attached outwards	B_{Ri} [mm]	Part No. attached inwards	Part No. attached outwards	B_{Ri} [mm]	Part No. attached inwards	Part No. attached outwards
.02	45	*	960.30.150	.03	58	*	960.30.150	.030	50	*	960.30.150
.03	58	*	960.30.150	.05	77	960.30.125	960.30.175	.040	60	*	960.30.175
.05	77	960.30.125	960.30.175	.07	97	960.30.150	960.30.200	.050	70	*	960.30.175
.07	97	960.30.150	960.30.200	.10	123	960.30.175	960.30.225	.060	80	960.30.150	960.30.175
.09	109	960.30.175	960.30.225					.070	90	960.30.150	960.30.200
.10	123	960.30.175	960.30.225					.080	100	960.30.150	960.30.200
.12	145	960.30.200	960.30.250					.090	110	960.30.175	960.30.225
								.100	120	960.30.175	960.30.225
								.110	130	960.30.200	960.30.225
								.120	140	960.30.200	960.30.250

*upon request

"Heavy Duty" Version | Installation set Part No. 971.50

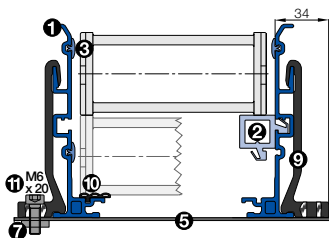

- **Components, trough "Heavy Duty":** ① Trough side parts, aluminum, 2 m ② Glide bar, plastic, 2 m ③ Glide strips, plastic 2 m (without glide strips on request) ⑩ Optional: Silencer profile, rubber
- **Components, installation set "Heavy Duty":** ⑤ C-profile, steel galvanized ⑦ Sliding nut M6 ⑧ Heavy duty bracket, aluminum ⑪ Screw M6 x 20



- = Guide trough
- = Glide bar
- = Installation set "Heavy duty"
- = C-profile

Note: Dimensions similar to Basic version!
Exception: Heavy duty bracket, see drawing

Insert for the installation set "Heavy-Duty": **971.50.XXX** instead of 960.30.XXX on the right column "attached outwards"

"Heavy Duty" installation set Part No. 971.50.150

! The inner width of the guide through and the length of the C-Profile of the assembly kit can differ according to the bracket you choose. Please call us!

Lengths of C-profile for Basic version - Bottom clamp attached optionally **inwards** or **outwards**

E4.28/R4.28

E4.28.070.250.0

B_{Ri} [mm]	Part No. attached inwards	Part No. attached outwards
.040 64	*	960.30.175
.050 74	960.30.125	960.30.175
.062 86	960.30.150	960.30.200
.070 94	960.30.150	960.30.200
.075 99	960.30.150	960.30.200
.087 111	960.30.175	960.30.225
.100 124	960.30.175	960.30.225
.125 149	960.30.200	960.30.250
.150 174	960.30.225	960.30.275
.175 199	960.30.250	960.30.300
.200 224	960.30.275	960.30.325
.225 249	960.30.300	960.30.350
.250 274	960.30.325	960.30.375
.275 299	960.30.350	960.30.400
.300 324	960.30.375	960.30.425

220/R760

220.070.250.0

B_{Ri} [mm]	Part No. attached inwards	Part No. attached outwards
.040 64	*	960.30.175
.050 74	960.30.125	960.30.175
.062 86	960.30.150	960.30.200
.070 94	960.30.150	960.30.200
.075 99	960.30.150	960.30.200
.087 111	960.30.175	960.30.225
.100 124	960.30.175	960.30.225
.125 149	960.30.200	960.30.250
.150 174	960.30.225	960.30.275
.175 199	960.30.250	960.30.300
.200 224	960.30.275	960.30.325
.225 249	960.30.300	960.30.350
.250 274	960.30.325	960.30.375
.275 299	960.30.350	960.30.400
.300 324	960.30.375	960.30.425

E6.35

E6.35.100.063.0

B_{Ri} [mm]	Part No. attached inwards	Part No. attached outwards
.030 54	*	960.30.150
.040 64	*	960.30.175
.050 74	960.30.125	960.30.175
.060 84	960.30.150	960.30.200
.070 94	960.30.150	960.30.200
.080 104	960.30.150	960.30.200
.090 114	960.30.175	960.30.225
.100 124	960.30.175	960.30.225
.110 134	960.30.200	960.30.250
.120 144	960.30.200	960.30.250

*upon request

"Heavy Duty" Version | **Installation set Part No. 972.50**

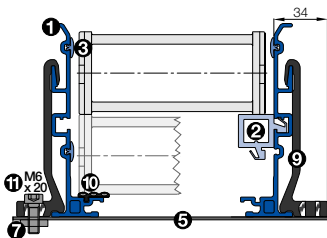

- **Components, trough "Heavy Duty":** ❶ Trough side parts, aluminum, 2 m ❷ Glide bar, plastic, 2 m ❸ Glide strips, plastic 2 m (without glide strips on request) ❹ Optional: Silencer profile, rubber
- **Components, installation set "Heavy Duty":** ❺ C-profile, steel galvanized ❻ Sliding nut M6 ❼ Heavy duty bracket, aluminum ❽ Screw M6 x 20



- = Führungsrinnen-Set
- = Gleitschiene
- = Montageset "Heavy duty"
- = C-Profil

Note: Dimensions similar to Basic version!
Exception: Heavy duty bracket, see drawing

Insert for the installation set "Heavy-Duty": **972.50.XXX** instead of 960.30.XXX on the right column "attached outwards"

"Heavy Duty" installation set Part No. 972.50.150

! The inner width of the guide through and the length of the C-Profile of the assembly kit can differ according to the bracket you choose. Please call us!



For the following
E-Chains®/E-Tubes:

System E4 Series

- E4.32/H4.32/R4.32
- 280/290/R770
- 2828/2928/R7728

System E6 Series

- E6.40/R6.40

B_a = Outer E-Chain® width
 B_i = Inner E-Chain® width
 h_a = E-Chain® outer height
 H_{Ri} = Inner trough height
 H_{Ra} = Outer trough height
 B_{Ri} = Inner trough width
depends on dim. B_a
 B_{Ra} = Outer trough width

! $H_{Ri} \geq 2 \cdot h_a$
■ $B_{Ri} \geq B_a + 4$

- = Guide trough
- = Glide bar
- = Installation set "Basic"
- = C-profile



Calculation - travel center mounted

Half travel length, rounded down to full 2 m sections = X m **guide trough length without glide bars** + X m **guide trough length with glide bars** + installation sets "Basic" (number of trough pieces + 1)

Supplement Part No. with the indicated C-profile-length-index.

Example: 960.30.150

C-profile length-index for your chosen trough inner width B_{Ri} ▶ see table on the right or the respective page for chosen series



Fixed end module - A quick fix for mounting the stationary end of an E-Chain® ▶ **page 9.16**

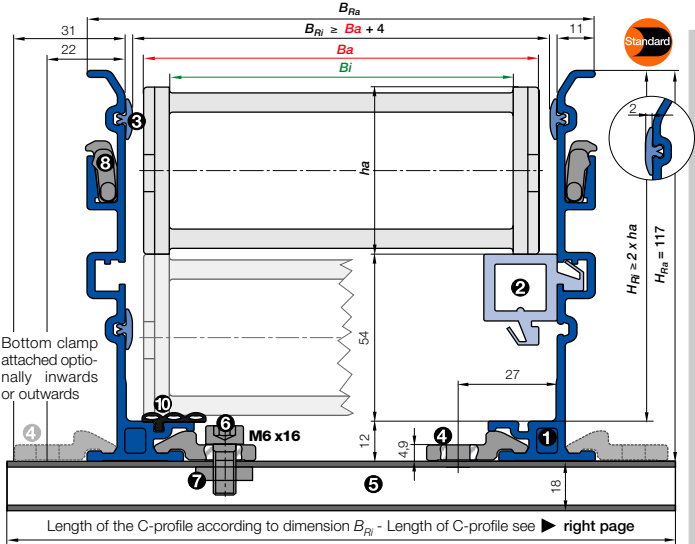

- **Components, trough "Basic":** ① Trough side parts, aluminum, 2 m ② Glide bar, plastic, 2 m ③ Glide strips, plastic, 2 m (without glide strips on request) ⑩ Optional: Silencer profile, rubber
- **Components, installation set "Basic":** ④ Bottom clamp, aluminum ⑤ C-profile, steel galvanized ⑥ Screw M6 x16 ⑦ Sliding nut M6 ⑧ Interface connector, plastic

Basic version: Aluminum "SuperTrough" components

Complete guide trough sets - description	Part No.	Weight	kg
① Set of 2 trough side parts, incl. glide strips, without glide bars, 2 m section	972.30.SL	= 6,00 kg	
① Set of 2 trough side parts, incl. glide strips, with glide bars, 2 m section	972.31.SL	= 7,40 kg	
1 Installation set "Basic" without C-profile	960.30	= 0,06 kg	
1 Installation set "Basic" with C-profile	960.30.		
Single parts - description			
⑥ 1 Glide strip, individual, 2 m section	75.01	= 0,06 kg	
⑩ 1 Silencer profile, rubber, individual, 2 m section	75.67.H		
④ 1 Bottom clamp, individual	75.40	= 0,03 kg	
⑧ 1 Interface connector, individual	75.60		
⑥ 1 Screw M6 x 16, individual	MAT 0040209		
⑦ 1 Sliding nut M6, individual	MAT 0040057		
② 1 Glide bar, individual, 2 m section	82.79	= 0,60 kg	
⑤ 1 C-profile, individual	92.52.	= 0,90 kg/m	



Order example: Length of travel 30 m - Center mounted for Series E4.32.07.200.0 with $B_{Ri} = 102$

Guide trough set (set of 2 trough side parts, incl. glide strips) without glide bar		
Order text: 16 m guide trough without glide bar (8 x 2 m sections)	Part No.	972.30.SL
Guide trough set (set of 2 trough side parts, incl. glide strips) with glide bar		
Order text: 16 m guide trough with glide bar (8 x 2 m sections)	Part No.	972.31.SL
Installation set "Basic" complete (guide trough-sets + 1)		
Order text: 17 installation sets "Basic"	Part No.	960.30.150
Module for the fixed end		
Order text: 1 set	Part No.	972.80
Option: For an additional noise dampening with silencer profile, please add Index A Example:	Part No.	972.30.SLA

Lengths of C-profile for Basic version - Bottom clamp attached optionally inwards or outwards

E4.32/H4.32/R4.32				280/290/R770				2828/2928/R7728				E6.40/R6.40			
E4.32.05.200.0				280.05.200.0				2828.05.200.0				E6.40.040.063.0			
B_{Ri} [mm]	Part No. attached inwards	Part No. attached outwards		B_{Ri} [mm]	Part No. attached inwards	Part No. attached outwards		B_{Ri} [mm]	Part No. attached inwards	Part No. attached outwards		B_{Ri} [mm]	Part No. attached inwards	Part No. attached outwards	
.05	77	960.30.125	960.30.175	.05	77	960.30.125	960.30.175	.05	78	960.30.125	960.30.175	.040	64	*	960.30.175
.06	95	960.30.150	960.30.200	.06	95	960.30.150	960.30.200	.06	96	960.30.150	960.30.200	.050	74	960.30.125	960.30.175
.07	102	960.30.150	960.30.200	.07	102	960.30.150	960.30.200	.07	103	960.30.150	960.30.200	.062	86	960.30.150	960.30.200
.087	114	960.30.175	960.30.225	.087	114	960.30.175	960.30.225	.087	115	960.30.175	960.30.225	.070	94	960.30.150	960.30.200
.10	127	960.30.175	960.30.225	.10	127	960.30.175	960.30.225	.10	128	960.30.175	960.30.225	.075	99	960.30.150	960.30.200
.11	135	960.30.200	960.30.250	.11	135	960.30.200	960.30.250	.11	136	960.30.200	960.30.225	.087	111	960.30.175	960.30.225
.112	140	960.30.200	960.30.250	.112	140	960.30.200	960.30.250	.112	141	960.30.200	960.30.250	.100	124	960.30.175	960.30.225
.12	152	960.30.200	960.30.250	.12	152	960.30.200	960.30.250	.12	153	960.30.200	960.30.250	.125	149	960.30.200	960.30.250
.137	165	960.30.225	960.30.275	.137	165	960.30.225	960.30.275	.137	166	960.30.225	960.30.275	.150	174	960.30.225	960.30.275
.15	177	960.30.225	960.30.275	.15	177	960.30.225	960.30.275	.15	178	960.30.225	960.30.275	.175	199	960.30.250	960.30.300
.162	190	960.30.250	960.30.300	.162	190	960.30.250	960.30.300	.162	191	960.30.250	960.30.300	.200	224	960.30.275	960.30.325
.17	195	960.30.250	960.30.300	.17	195	960.30.250	960.30.300	.17	196	960.30.250	960.30.300	.225	249	960.30.300	960.30.350
.18	202	960.30.250	960.30.300	.18	202	960.30.250	960.30.300	.18	203	960.30.250	960.30.300	.250	274	960.30.325	960.30.375
.187	215	960.30.275	960.30.325	.187	215	960.30.275	960.30.325	.187	216	960.30.275	960.30.325	.275	299	960.30.350	960.30.400
.20	227	960.30.275	960.30.325	.20	227	960.30.275	960.30.325	.20	228	960.30.275	960.30.325	.300	324	960.30.375	960.30.425
.212	240	960.30.300	960.30.350	.212	240	960.30.300	960.30.350	.212	241	960.30.300	960.30.350				
.23	252	960.30.300	960.30.350	.23	252	960.30.300	960.30.350	.23	253	960.30.300	960.30.350				
.237	265	960.30.325	960.30.375	.237	265	960.30.325	960.30.375	.237	266	960.30.325	960.30.375				
.25	277	960.30.325	960.30.375	.25	277	960.30.325	960.30.375	.25	278	960.30.325	960.30.375				
.262	290	960.30.350	960.30.400	.262	290	960.30.350	960.30.400	.262	291	960.30.350	960.30.400				
.28	302	960.30.350	960.30.400	.28	302	960.30.350	960.30.400	.28	303	960.30.350	960.30.400				
.29	315	960.30.375	960.30.425	.29	315	960.30.375	960.30.425	.29	316	960.30.375	960.30.425				
.30	327	960.30.375	960.30.425	.30	327	960.30.375	960.30.425	.30	328	960.30.375	960.30.425				
.312	340	960.30.400	960.30.450	.312	340	960.30.400	960.30.450	.312	341	960.30.400	960.30.450				
.325	352	960.30.400	960.30.450	.325	352	960.30.400	960.30.450	.325	353	960.30.400	960.30.450				
.337	365	960.30.425	960.30.475	.337	365	960.30.425	960.30.475	.337	366	960.30.425	960.30.475				
.350	377	960.30.425	960.30.475	.350	377	960.30.425	960.30.475	.350	378	960.30.425	960.30.475				
.362	390	960.30.450	960.30.500	.362	390	960.30.450	960.30.500	.362	391	960.30.450	960.30.500				
.375	402	960.30.450	960.30.500	.375	402	960.30.450	960.30.500	.375	403	960.30.450	960.30.500				
.387	415	960.30.475	960.30.525	.387	415	960.30.475	960.30.525	.387	416	960.30.475	960.30.525				
.400	427	960.30.475	960.30.525	.400	427	960.30.475	960.30.525	.400	428	960.30.475	960.30.525				

*upon request

"Heavy Duty" Version | Installation set Part No. 972.50

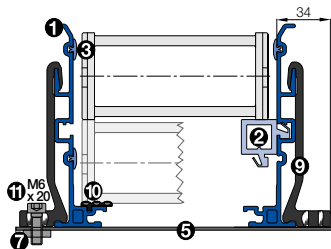

- Components, trough "Heavy Duty": ① Trough side parts, aluminum, 2 m ② Glide bar, plastic, 2 m ③ Glide strips, plastic 2 m (without glide strips on request) ⑩ Optional: Silencer profile, rubber
- Components, installation set "Heavy Duty": ⑤ C-profile, steel galvanized ⑦ Sliding nut M6 ⑧ Heavy duty bracket, aluminum ⑪ Screw M6 x 20



Note: Dimensions similar to Basic version!
Exception: Heavy duty bracket, see drawing

- = Guide trough
- = Glide bar
- = Installation set "Heavy duty"
- = C-profile

Insert for the installation set "Heavy-Duty": **972.50.XXX** instead of 960.30.XXX on the right column "attached outwards"

"Heavy Duty" installation set Part No. 972.50. 150

! The inner width of the guide through and the length of the C-Profile of the assembly kit can differ according to the bracket you choose. Please call us!



For the following
E-Chains®/E-Tubes:

System E2 Series

- 2700

System E2 E-Tubes

- R58

E2 medium classic

- 27 classic

B_a = Outer E-Chain® width
 B_i = Inner E-Chain® width
 h_a = E-Chain® outer height
 H_{Ri} = Inner trough height
 H_{Ra} = Outer trough height
 B_{Ri} = Inner trough width
depends on dim. B_a
 B_{Ra} = Outer trough width

! $H_{Ri} \geq 2 \cdot h_a$
■ $B_{Ri} \geq B_a + 4$

● = Guide trough

● = Glide bar

● = Installation set "Basic"

● = C-profile



Calculation - travel center mounted

Half travel length, rounded down to full 2 m sections = X m guide trough length without glide bars + X m guide trough length with glide bars + installation sets "Basic" (number of trough pieces + 1)

Supplement Part No. with the indicated C-profile-length-index.

Example : 960.30.150

C-profile length-index for your chosen trough inner width B_{Ri} see table on the right or the respective page for chosen series



Fixed end module - A quick fix for mounting the stationary end of an E-Chain® ▶ page 9.16

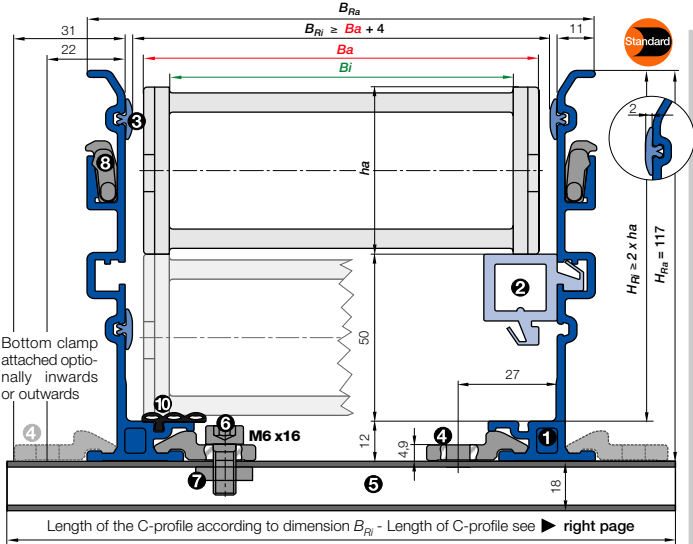

- **Components, trough "Basic":** ① Trough side parts, aluminum, 2 m ② Glide bar, plastic, 2 m ③ Glide strips, plastic, 2 m (without glide strips on request) ⑩ Optional: Silencer profile, rubber
- **Components, installation set "Basic":** ④ Bottom clamp, aluminum ⑤ C-profile, steel galvanized ⑥ Screw M6 x16 ⑦ Sliding nut M6 ⑧ Interface connector, plastic

Basic version: Aluminum "SuperTrough" components

Complete guide trough sets - description	Part No.	Weight	kg
① Set of 2 trough side parts, incl. glide strips, without glide bars, 2 m section	972.30.SL	= 6,00 kg	
① Set of 2 trough side parts, incl. glide strips, with glide bars, 2 m section	972.32.SL	= 7,40 kg	
1 Installation set "Basic" without C-profile	960.30	= 0,06 kg	
1 Installation set "Basic" with C-profile	960.30.		
Single parts - description			
⑥ 1 Glide strip, individual, 2 m section	75.01	= 0,06 kg	
⑩ 1 Silencer profile, rubber, individual, 2 m section	75.67.H		
④ 1 Bottom clamp, individual	75.40	= 0,03 kg	
⑧ 1 Interface connector, individual	75.60		
⑥ 1 Screw M6 x 16, individual	MAT 0040209		
⑦ 1 Sliding nut M6, individual	MAT 0040057		
② 1 Glide bar, individual, 2 m section	82.79	= 0,60 kg	
⑤ 1 C-profile, individual	92.52.	= 0,90 kg/m	



Order example: Length of travel 30 m - Center mounted for Series 2700.07.200.0 with $B_{Ri} = 95$

Guide trough set (set of 2 trough side parts, incl. glide strips) **without** glide bar
Order text: 16 m guide trough without glide bar (8 x 2 m sections) Part No. 972.30.SL

Guide trough set (set of 2 trough side parts, incl. glide strips) **with** glide bar
Order text: 16 m guide trough with glide bar (8 x 2 m sections) Part No. 972.32.SL

Installation set "Basic" complete (guide trough-sets + 1)
Order text: 17 installation sets "Basic" Part No. 960.30.150

Module for the fixed end
Order text: 1 set Part No. 972.81

Option: For an additional noise dampening with silencer profile, please add Index A Example:
Part No. 972.30.SLA

Lengths of C-profile for Basic version - Bottom clamp attached optionally **inwards** or **outwards**

2700

2700.05.200.0

B_{Ri} [mm]	Part No. attached inwards	Part No. attached outwards
.05 70	*	960.30.175
.06 85	960.30.150	960.30.200
.07 95	960.30.150	960.30.200
.09 110	960.30.175	960.30.225
.10 120	960.30.175	960.30.225
.12 145	960.30.200	960.30.250
.15 170	960.30.225	960.30.275
.17 198	960.30.250	960.30.300

R58

58.075.200.0

B_{Ri} [mm]	Part No. attached inwards	Part No. attached outwards
.050 70	*	960.30.175
.075 95	960.30.150	960.30.200
.100 120	960.30.175	960.30.225
.125 145	960.30.200	960.30.250
.150 170	960.30.225	960.30.275
.175 195	960.30.250	960.30.300
.200 220	960.30.275	960.30.325

*upon request

"Heavy Duty" Version | Installation set Part No. Nr. 972.50

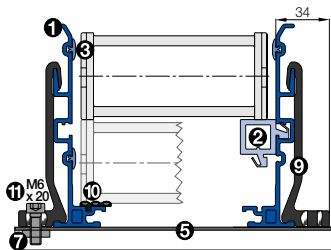

- **Components, trough "Heavy Duty":** ① Trough side parts, aluminum, 2 m ② Glide bar, plastic, 2 m ③ Glide strips, plastic 2 m (without glide strips on request) ⑩ Optional: Silencer profile, rubber
- **Components, installation set "Heavy Duty":** ⑤ C-profile, steel galvanized ⑦ Sliding nut M6 ⑧ Heavy duty bracket, aluminum ⑪ Screw M6 x 20



- = Guide trough
- = Glide bar
- = Installation set "Heavy duty"
- = C-profile

Note: Dimensions similar to Basic version!
Exception: Heavy duty bracket, see drawing



Insert for the installation set "Heavy-Duty": **972.50.XXX** instead of 960.30.XXX on the right column "attached outwards"

"Heavy Duty" installation set Part No. 972.50. 150

! The inner width of the guide trough and the length of the C-Profile of the assembly kit can differ according to the bracket you choose. Please call us!



For the following
E-Chains®/E-Tubes:

System E2 Series

- 3500

System E2 E-Tubes Series

- R68

System E4 Series

- E4.42/H4.42/R4.42
- 380/390/R780

System E6 Series

- E6.52/R6.52

E2 medium classic

- 350 classic

B_a = Outer E-Chain® width
 B_i = Inner E-Chain® width
 h_a = E-Chain® outer height
 H_{Ri} = Inner trough height
 H_{Ra} = Outer trough height
 B_{Ri} = Inner trough width
 B_{Ra} = Outer trough width

! $H_{Ri} \geq 2 \cdot h_a$
■ $B_{Ri} \geq B_a + 4$

- = Guide trough
- = Glide bar
- = Installation set "Basic"
- = C-profile



Calculation - travel center mounted

Half travel length, rounded down to full 2 m sections = X m **guide trough length without glide bars** + X m **guide trough length with glide bars** + installation sets "Basic" (number of trough pieces + 1)

Supplement Part No. with the indicated C-profile-length-index.

Example: 960.40.175

C-profile length-index for your chosen trough inner width B_{Ri} ▶ see table on the right or the respective page for chosen series



Fixed end module - A quick fix for mounting the stationary end of an E-Chain® ▶ page 9.16

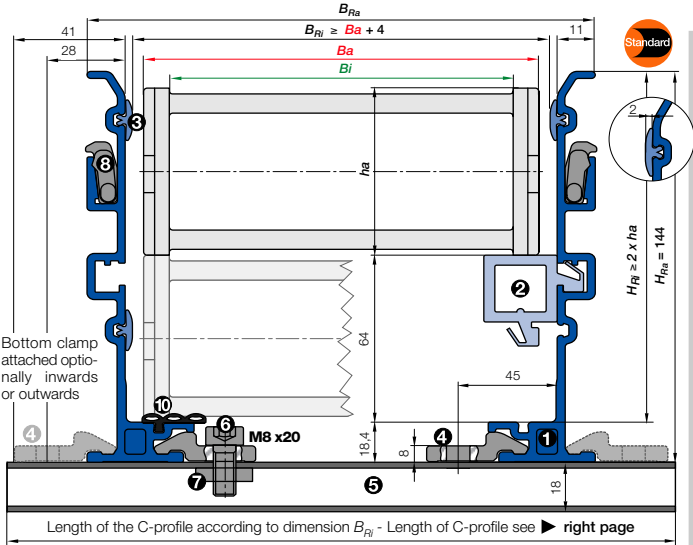

- **Components, trough "Basic":** ① Trough side parts, aluminum, 2 m ② Glide bar, plastic, 2 m ③ Glide strips, plastic, 2 m (without glide strips on request) ⑩ Optional: Silencer profile, rubber
- **Components, installation set "Basic":** ④ Bottom clamp, aluminum ⑤ C-profile, steel galvanized ⑥ Screw M8 x 20 ⑦ Sliding nut M8 ⑧ Interface connector, plastic

Basic version: Aluminum "SuperTrough" components

Complete guide trough sets - description	Part No.	Weight	kg
① Set of 2 trough side parts, incl. glide strips, without glide bars, 2 m section	973.30.SL	≈ 8,00	kg
① Set of 2 trough side parts, incl. glide strips, with glide bars, 2 m section	973.31.SL	≈ 10,8	kg
1 Installation set "Basic" without C-profile	960.40.	≈ 0,08	kg
1 Installation set "Basic" with C-profile	960.40.		
Single parts - description			
⑥ 1 Glide strip, individual, 2 m section	75.01	≈ 0,06	kg
⑩ 1 Silencer profile, rubber, individual, 2 m section	75.68.H		
④ 1 Bottom clamp, individual	75.50	≈ 0,04	kg
⑧ 1 Interface connector, individual	75.60		
⑥ 1 Screw M8 x 20, individual	MAT 0040445		
⑦ 1 Sliding nut M8, individual	MAT 0040413		
② 1 Glide bar, individual, 2 m section	83.79	≈ 1,30	kg
⑤ 1 C-profile, individual	92.52.	≈ 0,90	kg/m



Order example: Length of travel 30 m - Center mounted for Series 3500.100.200.0 with $B_{Ri} = 124$

Guide trough set (set of 2 trough side parts, incl. glide strips) **without** glide bar
Order text: 16 m guide trough without glide bar (8 x 2 m sections) Part No. 973.30.SL

Guide trough set (set of 2 trough side parts, incl. glide strips) **with** glide bar
Order text: 16 m guide trough with glide bar (8 x 2 m sections) Part No. 973.31.SL

Installation set "Basic" complete (guide trough-sets + 1)
Order text: 17 installation sets "Basic" Part No. 960.40.175

Module for the fixed end
Order text: 1 set Part No. 973.80

Option: For an additional noise dampening with silencer profile, please add Index A Example:
Part No. 973.30.SLA

Lengths of C-profile for Basic version - Bottom clamp attached optionally inwards or outwards

3500			E4.42/H4.42/R4.42			380/390/R780			3838/3938/R7838			E6.52/R6.52			
3500.050.200.0			E4.42.05.200.0			380.05.200.0			3838.05.200.0			E6.52.040.200.0			
B_{Ri} [mm]	Part No. attached inwards	Part No. attached outwards	B_{Ri} [mm]	Part No. attached inwards	Part No. attached outwards	B_{Ri} [mm]	Part No. attached inwards	Part No. attached outwards	B_{Ri} [mm]	Part No. attached inwards	Part No. attached outwards	B_{Ri} [mm]	Part No. attached inwards	Part No. attached outwards	
.050	74 *	960.40.200	.05	80 *	960.40.200	.05	80 *	960.40.200	.05	81 *	960.40.200	.040	68 *	960.40.200	
.075	99 *	960.40.225	.06	98 *	960.40.225	.06	98 *	960.40.225	.06	99 *	960.40.225	.050	78 *	960.40.200	
.100	124	960.40.175	960.40.250	.07	105 *	960.40.225	.07	105 *	960.40.225	.07	106 *	960.40.225	.062	90 *	960.40.225
.115	139	960.40.200	960.40.275	.087	118	960.40.175	960.40.250	.087	118	960.40.175	960.40.250	.070	98 *	960.40.225	
.125	149	960.40.200	960.40.275	.10	130	960.40.200	960.40.250	.10	130	960.40.200	960.40.250	.075	103 *	960.40.225	
.150	174	960.40.225	960.40.300	.11	138	960.40.200	960.40.275	.11	138	960.40.200	960.40.275	.087	115 *	960.40.250	
.175	199	960.40.250	960.40.325	.112	143	960.40.200	960.40.275	.112	143	960.40.200	960.40.275	.100	128	960.40.175	960.40.250
.200	224	960.40.275	960.40.350	.12	155	960.40.225	960.40.275	.12	155	960.40.225	960.40.275	.125	153	960.40.200	960.40.275
.225	249	960.40.300	960.40.375	.137	168	960.40.225	960.40.300	.137	168	960.40.225	960.40.300	.137	169	960.40.225	960.40.300
.250	274	960.40.325	960.40.400	.15	180	960.40.250	960.40.300	.15	180	960.40.250	960.40.300	.15	181	960.40.250	960.40.300
				.162	193	960.40.250	960.40.325	.162	193	960.40.250	960.40.325	.162	194	960.40.250	960.40.325
				.17	198	960.40.250	960.40.325	.17	198	960.40.250	960.40.325	.17	199	960.40.250	960.40.325
				.18	205	960.40.275	960.40.325	.18	205	960.40.275	960.40.325	.18	206	960.40.275	960.40.325
				.187	218	960.40.275	960.40.350	.187	218	960.40.275	960.40.350	.187	219	960.40.275	960.40.350
				.20	230	960.40.300	960.40.350	.20	230	960.40.300	960.40.350	.20	231	960.40.300	960.40.350
				.212	243	960.40.300	960.40.375	.212	243	960.40.300	960.40.375	.212	244	960.40.300	960.40.375
				.23	255	960.40.325	960.40.375	.23	255	960.40.325	960.40.375	.23	256	960.40.325	960.40.375
				.237	268	960.40.325	960.40.400	.237	268	960.40.325	960.40.400	.237	269	960.40.325	960.40.400
				.25	280	960.40.350	960.40.400	.25	280	960.40.350	960.40.400	.25	281	960.40.350	960.40.400
				.262	293	960.40.350	960.40.425	.262	293	960.40.350	960.40.425	.262	294	960.40.350	960.40.425
				.28	305	960.40.375	960.40.425	.28	305	960.40.375	960.40.425	.28	306	960.40.375	960.40.425
				.29	318	960.40.375	960.40.450	.29	318	960.40.375	960.40.450	.29	319	960.40.375	960.40.450
				.30	330	960.40.400	960.40.450	.30	330	960.40.400	960.40.450	.30	331	960.40.400	960.40.450
				.312	343	960.40.400	960.40.475	.312	343	960.40.400	960.40.475	.312	344	960.40.400	960.40.475
				.325	355	960.40.425	960.40.475	.325	355	960.40.425	960.40.475	.325	356	960.40.425	960.40.475
				.337	368	960.40.425	960.40.500	.337	368	960.40.425	960.40.500	.337	369	960.40.425	960.40.500
				.350	380	960.40.450	960.40.500	.350	380	960.40.450	960.40.500	.350	381	960.40.450	960.40.500
				.362	393	960.40.450	960.40.525	.362	393	960.40.450	960.40.525	.362	394	960.40.450	960.40.525
				.375	406	960.40.475	960.40.525	.375	406	960.40.475	960.40.525	.375	406	960.40.475	960.40.525
				.387	418	960.40.475	960.40.550	.387	418	960.40.475	960.40.550	.387	419	960.40.475	960.40.550
				.400	430	960.40.500	960.40.550	.400	430	960.40.500	960.40.550	.400	431	960.40.500	960.40.550

R68

68.050.200.0

B_{Ri} [mm]	Part No. attached inwards	Part No. attached outwards	B_{Ri} [mm]	Part No. attached inwards	Part No. attached outwards	B_{Ri} [mm]	Part No. attached inwards	Part No. attached outwards	B_{Ri} [mm]	Part No. attached inwards	Part No. attached outwards	B_{Ri} [mm]	Part No. attached inwards	Part No. attached outwards	
.050	72 *	960.40.200	.262	293	960.40.350	960.40.425	.262	293	960.40.350	960.40.425	.262	294	960.40.350	960.40.425	
.075	97 *	960.40.225	.28	305	960.40.375	960.40.425	.28	305	960.40.375	960.40.425	.28	306	960.40.375	960.40.425	
.100	122	960.40.175	960.40.250	.29	318	960.40.375	960.40.450	.29	318	960.40.375	960.40.450	.29	319	960.40.375	960.40.450
.115	137	960.40.200	960.40.275	.30	330	960.40.400	960.40.450	.30	330	960.40.400	960.40.450	.30	331	960.40.400	960.40.450
.125	147	960.40.200	960.40.275	.312	343	960.40.400	960.40.475	.312	343	960.40.400	960.40.475	.312	344	960.40.400	960.40.475
.150	172	960.40.225	960.40.300	.325	355	960.40.425	960.40.475	.325	355	960.40.425	960.40.475	.325	356	960.40.425	960.40.475
.175	197	960.40.250	960.40.325	.337	368	960.40.425	960.40.500	.337	368	960.40.425	960.40.500	.337	369	960.40.425	960.40.500
.200	222	960.40.275	960.40.350	.350	380	960.40.450	960.40.500	.350	380	960.40.450	960.40.500	.350	381	960.40.450	960.40.500
.225	247	960.40.300	960.40.375	.362	393	960.40.450	960.40.525	.362	393	960.40.450	960.40.525	.362	394	960.40.450	960.40.525
.250	272	960.40.325	960.40.400	.375	406	960.40.475	960.40.525	.375	406	960.40.475	960.40.525	.375	406	960.40.475	960.40.525
				.387	418	960.40.475	960.40.550	.387	418	960.40.475	960.40.550	.387	419	960.40.475	960.40.550
				.400	430	960.40.500	960.40.550	.400	430	960.40.500	960.40.550	.400	431	960.40.500	960.40.550

*upon request

"Heavy Duty" Version | Installation set Part No. 973.50

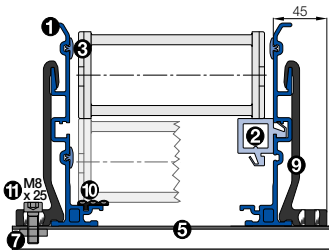

- Components, trough "Heavy Duty": ① Trough side parts, aluminum, 2 m ② Glide bar, plastic, 2 m ③ Glide strips, plastic 2 m (without glide strips on request) ⑩ Optional: Silencer profile, rubber
- Components, installation set "Heavy Duty": ⑤ C-profile, steel galvanized ⑦ Sliding nut M8 ⑧ Heavy duty bracket, aluminum ⑪ Screw M8 x 25



- = Guide trough
- = Glide bar
- = Installation set "Heavy duty"
- = C-profile

Note: Dimensions similar to Basic version!
Exception: Heavy duty bracket, see drawing

Insert for the installation set "Heavy-Duty": **973.50.XXX** instead of **960.40.XXX** on the right column "attached outwards"
"Heavy Duty" installation set Part No **973.50.175**

! The inner width of the guide through and the length of the C-Profile of the assembly kit can differ according to the bracket you choose. Please call us!



For the following
E-Chains*/E-Tubes:

System E4 Series

- E4.56/H4.56/R4.56
- 400/410/R880
- 4040/4140/R8840
- 14040/14140/R18840
- 14240/14340

System E6 Series

- E6.62

B_a = Outer E-Chain* width
 B_i = Inner E-Chain* width
 h_a = E-Chain* outer height
 H_{Ri} = Inner trough height
 H_{Ra} = Outer trough height
 B_{Ri} = Inner trough width
 depends on dim. B_a
 B_{Ra} = Outer trough width

! $H_{Ri} \geq 2 \cdot h_a$
 $B_{Ri} \geq B_a + 4$

- = Guide trough
- = Glide bar
- = Installation set "Basic"
- = C-profile



Calculation - travel center mounted

Half travel length, rounded down to full 2 m sections = X m **guide trough length without glide bars** + X m **guide trough length with glide bars** + installation sets "Basic" (number of trough pieces + 1)

Supplement Part No. with the indicated C-profile-length-index.

Example: 960.50.200

C-profile length-index for your chosen trough inner width B_{Ri} ▶ see table on the right or the respective page for chosen series



Fixed end module - A quick fix for mounting the stationary end of an E-Chain* ▶ **page 9.16**

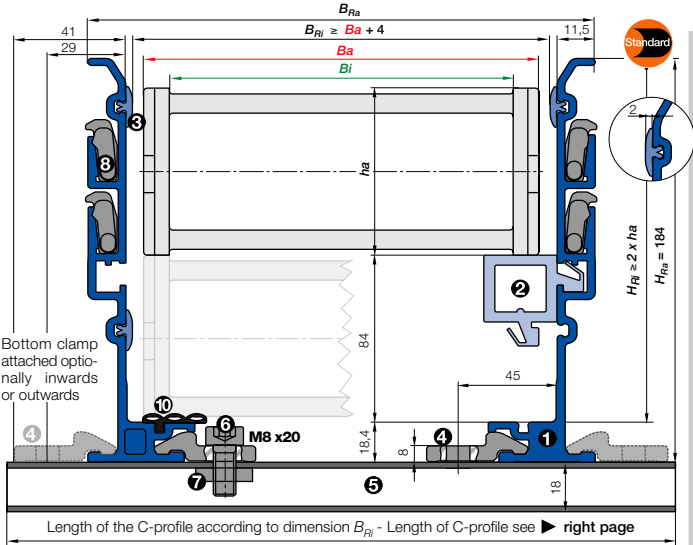

- **Components, trough "Basic":** ① Trough side parts, aluminum, 2 m ② Glide bar, plastic, 2 m ③ Glide strips, plastic, 2 m (without glide strips on request) ⑩ Optional: Silencer profile, rubber
- **Components, installation set "Basic":** ④ Bottom clamp, aluminum ⑤ C-profile, steel galvanized ⑥ Screw M8 x 20 ⑦ Sliding nut M8 ⑧ Interface connector, plastic

Basic version: Aluminum "SuperTrough" components

Complete guide trough sets - description	Part No.	Weight	kg
① Set of 2 trough side parts, incl. glide strips, without glide bars, 2 m section	974.30.SL	≈ 10,0	kg
① Set of 2 trough side parts, incl. glide strips, with glide bars, 2 m section	974.31.SL	≈ 12,8	kg
1 Installation set "Basic" without C-profile	960.50	≈ 0,08	kg
1 Installation set "Basic" with C-profile	960.50.		
Single parts - description			
⑥ 1 Glide strip, individual, 2 m section	75.01	≈ 0,06	kg
⑩ 1 Silencer profile, rubber, individual, 2 m section	75.68.H		
④ 1 Bottom clamp, individual	75.50	≈ 0,04	kg
⑧ 1 Interface connector, individual	75.60		
⑥ 1 Screw M8 x 20, individual	MAT 0040445		
⑦ 1 Sliding nut M8, individual	MAT 0040413		
② 1 Glide bar, individual, 2 m section	83.79	≈ 1,30	kg
⑤ 1 C-profile, individual	92.52.	≈ 0,90	kg/m



Order example: Length of travel 30 m - Center mounted for Series E4.56.10.250.0 with $B_{Ri} = 138$

Guide trough set (set of 2 trough side parts, incl. glide strips) **without** glide bar
Order text: 16 m guide trough without glide bar (8 x 2 m sections) Part No. **974.30.SL**

Guide trough set (set of 2 trough side parts, incl. glide strips) **with** glide bar
Order text: 16 m guide trough with glide bar (8 x 2 m sections) Part No. **974.31.SL**

Installation set "Basic" complete (guide trough-sets + 1)
Order text: 17 installation sets "Basic" Part No. **960.50.200**

Module for the fixed end
Order text: 1 set Part No. **974.80**

Option: For an additional noise dampening with silencer profile, please add Index A Example: Part No. **974.30.SLA**

Lengths of C-profile for Basic version - Bottom clamp attached optionally inwards or outwards

E4.56/H4.56/R4.56			400/410/R880			4040/4140/R8840			14040/14140/R18840			14240/14340			E6.62		
E4.56.05.200.0			400.05.200.0			4040.05.200.0			14040.05.200.0			14240.05.200.0			E6.62.05.200.0		
B_{Ri} [mm]	Part No. attached inwards	Part No. attached outwards	B_{Ri} [mm]	Part No. attached inwards	Part No. attached outwards	B_{Ri} [mm]	Part No. attached inwards	Part No. attached outwards	B_{Ri} [mm]	Part No. attached inwards	Part No. attached outwards	B_{Ri} [mm]	Part No. attached inwards	Part No. attached outwards	B_{Ri} [mm]	Part No. attached inwards	Part No. attached outwards
.05 88	*	960.50.225	.05 88	*	960.50.225	.05 90	*	960.50.225	.05 80	*	960.50.200	.05 80	*	960.50.200	.05 90	*	960.50.225
.06 103	*	960.50.225	.06 103	*	960.50.225	.06 105	*	960.50.225	.06 95	*	960.50.225	.06 98	*	960.50.225	.06 108	*	960.50.225
.07 113	*	960.50.250	.07 113	*	960.50.250	.07 115	*	960.50.250	.07 105	*	960.50.225	.07 105	*	960.50.225	.07 115	*	960.50.250
.08 125	960.50.175	960.50.250	.08 125	960.50.175	960.50.250	.08 127	960.50.175	960.50.250	.08 117	960.50.175	960.50.225	.08 118	960.50.175	960.50.250	.08 127	960.50.175	960.50.250
.10 138	960.50.200	960.50.275	.10 138	960.50.200	960.50.275	.10 140	960.50.200	960.50.275	.10 130	960.50.200	960.50.250	.10 130	960.50.200	960.50.250	.10 140	960.50.200	960.50.275
.15 188	960.50.250	960.50.325	.15 188	960.50.250	960.50.325	.15 190	960.50.250	960.50.325	.15 180	960.50.250	960.50.300	.15 180	960.50.225	960.50.300	.15 188	960.50.225	960.50.300
.16 201	960.50.250	960.50.325	.16 201	960.50.250	960.50.325	.16 203	960.50.250	960.50.325	.16 193	960.50.250	960.50.325	.15 180	960.50.250	960.50.300	.15 190	960.50.250	960.50.325
.17 213	960.50.275	960.50.350	.17 213	960.50.275	960.50.350	.17 215	960.50.275	960.50.350	.17 205	960.50.275	960.50.325	.16 213	960.50.250	960.50.325	.16 220	960.50.250	960.50.325
.18 226	960.50.275	960.50.350	.18 226	960.50.275	960.50.350	.18 228	960.50.275	960.50.350	.18 218	960.50.275	960.50.350	.17 198	960.50.250	960.50.325	.17 208	960.50.275	960.50.325
.20 238	960.50.300	960.50.375	.20 238	960.50.300	960.50.375	.20 240	960.50.300	960.50.375	.20 230	960.50.300	960.50.350	.18 205	960.50.275	960.50.325	.18 215	960.50.275	960.50.350
.21 251	960.50.300	960.50.375	.21 251	960.50.300	960.50.375	.21 253	960.50.300	960.50.375	.21 243	960.50.300	960.50.375	.18 218	960.50.275	960.50.350	.18 227	960.50.275	960.50.350
.22 263	960.50.325	960.50.400	.22 263	960.50.325	960.50.400	.22 265	960.50.325	960.50.400	.22 255	960.50.325	960.50.375	.20 230	960.50.300	960.50.350	.20 240	960.50.300	960.50.375
.23 276	960.50.325	960.50.400	.23 276	960.50.325	960.50.400	.23 278	960.50.325	960.50.400	.23 268	960.50.325	960.50.400	.21 243	960.50.300	960.50.375	.21 252	960.50.300	960.50.375
.25 288	960.50.350	960.50.425	.25 288	960.50.350	960.50.425	.25 290	960.50.350	960.50.425	.25 280	960.50.350	960.50.400	.23 255	960.50.325	960.50.375	.23 265	960.50.325	960.50.400
.26 301	960.50.350	960.50.425	.26 301	960.50.350	960.50.425	.26 303	960.50.350	960.50.425	.26 293	960.50.350	960.50.425	.23 268	960.50.325	960.50.400	.23 277	960.50.325	960.50.400
.27 313	960.50.375	960.50.450	.27 313	960.50.375	960.50.450	.27 315	960.50.375	960.50.450	.27 305	960.375	960.50.425	.25 280	960.50.350	960.50.400	.25 290	960.50.350	960.50.425
.28 326	960.50.375	960.50.450	.28 326	960.50.375	960.50.450	.28 328	960.50.375	960.50.450	.28 318	960.50.375	960.50.450	.26 293	960.50.350	960.50.425	.26 302	960.50.350	960.50.425
.30 338	960.50.400	960.50.475	.30 338	960.50.400	960.50.475	.30 340	960.50.400	960.50.475	.30 330	960.50.400	960.50.450	.28 305	960.50.375	960.50.425	.28 315	960.50.375	960.50.450
.31 351	960.50.400	960.50.475	.31 351	960.50.400	960.50.475	.31 353	960.50.400	960.50.475	.31 343	960.50.400	960.50.475	.29 318	960.50.375	960.50.450	.29 327	960.50.375	960.50.450
.32 363	960.50.425	960.50.500	.32 363	960.50.425	960.50.500	.32 365	960.50.425	960.50.500	.32 355	960.50.425	960.50.475	.30 330	960.50.400	960.50.450	.30 340	960.50.400	960.50.475
.33 376	960.50.425	960.50.500	.33 376	960.50.425	960.50.500	.33 378	960.50.425	960.50.500	.33 368	960.50.425	960.50.500	.31 2343	960.50.400	960.50.475	.31 2352	960.50.400	960.50.475
.35 388	960.50.450	960.50.525	.35 388	960.50.450	960.50.525	.35 390	960.50.450	960.50.525	.35 380	960.50.450	960.50.500	.32 355	960.50.425	960.50.475	.32 365	960.50.425	960.50.500
.36 401	960.50.450	960.50.525	.36 401	960.50.450	960.50.525	.36 403	960.50.450	960.50.525	.36 393	960.50.450	960.50.525	.33 378	960.50.425	960.50.500	.33 387	960.50.425	960.50.500
.37 413	960.50.475	960.50.550	.37 413	960.50.475	960.50.550	.37 415	960.50.475	960.50.550	.37 405	960.50.475	960.50.525	.35 380	960.50.450	960.50.500	.35 390	960.50.450	960.50.525
.38 426	960.50.475	960.50.550	.38 426	960.50.475	960.50.550	.38 428	960.50.475	960.50.550	.38 418	960.50.475	960.50.550	.36 2393	960.50.450	960.50.525	.36 2402	960.50.450	960.50.525
.40 438	960.50.500	960.50.575	.40 438	960.50.500	960.50.575	.40 440	960.50.500	960.50.575	.40 430	960.50.500	960.50.550	.37 405	960.50.475	960.50.525	.37 415	960.50.475	960.50.550
.41 451	960.50.500	960.50.575	.41 451	960.50.500	960.50.575	.41 453	960.50.500	960.50.575	.41 443	960.50.500	960.50.575	.38 418	960.50.475	960.50.525	.38 427	960.50.475	960.50.550
.42 463	960.50.525	960.50.600	.42 463	960.50.525	960.50.600	.42 465	960.50.525	960.50.600	.42 455	960.50.525	960.50.575	.40 430	960.50.500	960.50.550	.40 440	960.50.500	960.50.575
.43 476	960.50.525	960.50.600	.43 476	960.50.525	960.50.600	.43 478	960.50.525	960.50.600	.43 468	960.50.525	960.50.600	.43 468	960.50.525	960.50.600	.43 477	960.50.525	960.50.600
.45 488	960.50.550	960.50.625	.45 488	960.50.550	960.50.625	.45 490	960.50.550	960.50.625	.45 480	960.50.550	960.50.600	.45 480	960.50.550	960.50.600	.45 489	960.50.550	960.50.625
.46 501	960.50.550	960.50.625	.46 501	960.50.550	960.50.625	.46 503	960.50.550	960.50.625	.46 493	960.50.550	960.50.625	.46 493	960.50.550	960.50.625	.46 492	960.50.550	960.50.625
.47 513	960.50.575	960.50.650	.47 513	960.50.575	960.50.650	.47 515	960.50.575	960.50.650	.47 505	960.50.575	960.50.625	.47 505	960.50.575	960.50.625	.47 504	960.50.575	960.50.625
.48 526	960.50.575	960.50.650	.48 526	960.50.575	960.50.650	.48 528	960.50.575	960.50.650	.48 518	960.50.575	960.50.650	.48 518	960.50.575	960.50.650	.48 517	960.50.575	960.50.650
.50 538	960.50.600	960.50.675	.50 538	960.50.600	960.50.675	.50 540	960.50.600	960.50.675	.50 530	960.50.600	960.50.650	.50 530	960.50.600	960.50.650	.50 529	960.50.600	960.50.650
.51 551	960.50.600	960.50.675	.51 551	960.50.600	960.50.675	.51 553	960.50.600	960.50.675	.51 543	960.50.600	960.50.675	.51 543	960.50.600	960.50.675	.51 542	960.50.600	960.50.675
.52 563	960.50.625	960.50.700	.52 563	960.50.625	960.50.700	.52 565	960.50.625	960.50.700	.52 555	960.50.625	960.50.675	.52 555	960.50.625	960.50.675	.52 554	960.50.625	960.50.675
.53 576	960.50.625	960.50.700	.53 576	960.50.625	960.50.700	.53 578	960.50.625	960.50.700	.53 568	960.50.625	960.50.700	.53 568	960.50.625	960.50.700	.53 567	960.50.625	960.50.700
.55 588	960.50.650	960.50.725	.55 588	960.50.650	960.50.725	.55 590	960.50.650	960.50.725	.55 580	960.50.650	960.50.700	.55 580	960.50.650	960.50.700	.55 579	960.50.650	960.50.700
.60 638	960.50.700	960.50.775	.60 638	960.50.700	960.50.775	.60 640	960.50.700	960.50.775	.60 630	960.50.700	960.50.750						upon request

"Heavy Duty" Version | Installation set Part No. 974.50

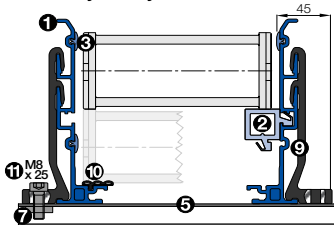

- Components, trough "Heavy Duty": ❶ Trough side parts, aluminum, 2 m ❷ Glide bar, plastic, 2 m ❸ Glide strips, plastic 2 m (without glide strips on request) ❹ Optional: Silencer profile, rubber
- Components, installation set "Heavy Duty": ❺ C-profile, steel galvanized ❻ Sliding nut M8 ❼ Heavy duty bracket, aluminum ❶ Screw M8 x 25

Note: Dimensions similar to Basic version!
Exception: Heavy duty bracket, see drawing



- = Guide trough
- = Glide bar
- = Installation set "Heavy duty"
- = C-profile

Insert for the installation set "Heavy-Duty": **974.50.XXX** instead of **960.50.XXX** on the right column "attached outwards"

"Heavy Duty" installation set Part No. 974.50. 200

! The inner width of the guide through and the length of the C-Profile of the assembly kit can differ according to the bracket you choose. Please call us!



For the following
E-Chains®/E-Tubes:

System E4 Series

- 4040HD/R8840HD

We especially recommend for the igus® E4/4 series 4040 HD (Heavy Duty) this trough system. Structurally identical with trough 974.30.SL yet with special HD-installation set, suitable for ambitious applications.

- B_a = Outer E-Chain® width
 - B_i = Inner E-Chain® width
 - h_a = E-Chain® outer height
 - H_{Ri} = Inner trough height
 - H_{Ra} = Outer trough height
 - B_{Ri} = Inner trough width
 - B_{Ra} = Outer trough width
- ▶ depends on dim. B_a

! $H_{Ri} \geq 2 \cdot h_a$
■ $B_{Ri} \geq B_a + 4$

- = Guide trough
- = Glide bar
- = Installation set
- = C-profile



Calculation - travel
center mounted

Half travel length, rounded down to full 2 m sections = X m guide trough length without glide bars + X m guide trough length with glide bars + installation sets (number of trough pieces + 1)

Supplement Part No. with the indicated C-profile-length-index.

Example: 974.50. 200

C-profile length-index for your chosen trough inner width B_{Ri} ▶ see table on the right or the respective page for chosen series

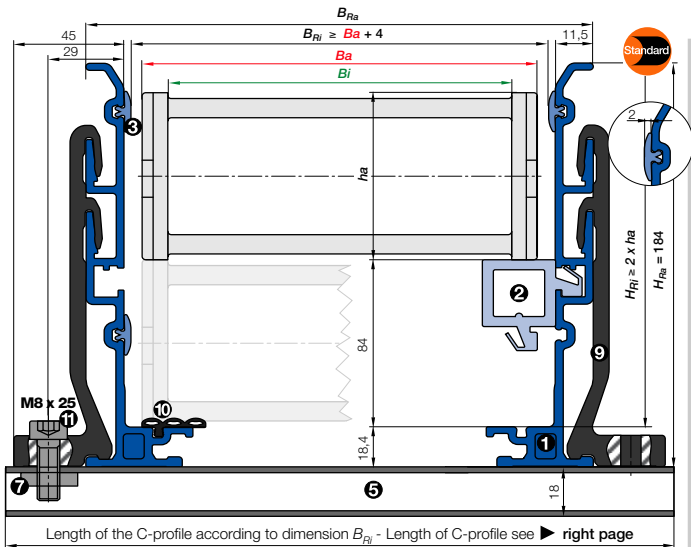

- Components, trough "Heavy Duty": ① Trough side parts, aluminum, 2 m ② Glide bar, plastic, 2 m ③ Glide strips, plastic, 2 m (without glide strips on request) ⑩ Optional: Silencer profile, rubber
- Components, installation set "Heavy Duty": ⑤ C-profile, steel galvanized ⑦ Sliding nut M8 ⑨ Heavy duty bracket, aluminum ⑪ Screw M8 x 25

Heavy Duty version: Aluminum "SuperTrough" components

Complete guide trough sets - description	Part No.	Weight	kg
① Set of 2 trough side parts, incl. glide strips, without glide bars, 2 m section	974.30.SL	≈ 10,0 kg	
② Set of 2 trough side parts, incl. glide strips, with glide bars, 2 m section	974.31.SL	≈ 12,8 kg	
③ 1 Installation set "Heavy Duty" without C-profile	974.50	≈ 0,40 kg	
1 Installation set "Heavy Duty" with C-profile	974.50. <input type="text"/>		
Single parts - description			
⑥ 1 Glide strip, individual, 2 m section	75.01	≈ 0,06 kg	
⑩ 1 Silencer profile, rubber, individual, 2 m section	75.68.H		
⑪ 1 Screw M8 x 25, individual	MAT 0040445		
⑦ 1 Sliding nut M8, individual	MAT 0040413		
② 1 Glide bar, individual, 2 m section	83.79	≈ 1,30 kg	
⑤ 1 C-profile, individual	92.52. <input type="text"/>	≈ 0,90 kg/m	



Order example: Length of travel 30 m -
Center mounted for Series 4040HD.10.250.0 with $B_{Ri} = 158$

Guide trough set (set of 2 trough side parts, incl. glide strips) without glide bar		
Order text: 16 m guide trough without glide bar (8 x 2 m sections)	Part No.	974.30.SL
Guide trough set (set of 2 trough side parts, incl. glide strips) with glide bar		
Order text: 16 m guide trough with glide bar (8 x 2 m sections)	Part No.	974.31.SL
Installation set "Heavy Duty" complete (guide trough-sets + 1)		
Order text: 17 installation sets "Heavy Duty"	Part No.	974.50. <u>275</u>
Module for the fixed end		
Order text: 1 set	Part No.	974.80
Option: For an additional noise dampening with silencer profile, please add Index A Example:	Part No.	974.30.SLA

Lengths of C-profile

4040HD/R8840HD

4040HD.05.250.0

B_H [mm]	Part No. assembled
.05 108	974.50.225
.06 123	974.50.250
.07 133	974.50.250
.08 146	974.50.275
.10 158	974.50.275
.11 170	974.50.300
.12 183	974.50.300
.13 195	974.50.325
.15 208	974.50.325
.16 220	974.50.350
.17 233	974.50.350
.18 245	974.50.375
.20 258	974.50.375
.21 270	974.50.400
.22 283	974.50.400
.23 295	974.50.425
.25 308	974.50.425
.26 320	974.50.450
.27 333	974.50.450
.28 345	974.50.475
.30 358	974.50.475
.31 370	974.50.500
.32 383	974.50.500
.33 395	974.50.525
.35 408	974.50.525
.36 420	974.50.550
.37 433	974.50.550
.38 445	974.50.575
.40 458	974.50.575
.41 470	974.50.600
.42 483	974.50.600
.43 495	974.50.625
.45 508	974.50.625
.46 520	974.50.650
.47 533	974.50.650
.48 545	974.50.675
.50 558	974.50.675
.51 570	974.50.700
.52 583	974.50.700
.53 595	974.50.725
.55 608	974.50.725
.60 658	974.50.775

! The inner width of the guide through and the length of the C-Profile of the assembly kit can differ according to the bracket you choose. Please call us!



For the following
E-Chains*/E-Tubes:

System E4 Series

- E4.80/H4.80/R4.80
- 5050/5150/R9850
- 15050/15150/R19850

System E6 Series

- E6.80

B_a = Outer E-Chain* width
 B_i = Inner E-Chain* width
 h_a = E-Chain* outer height
 H_{Ri} = Inner trough height
 H_{Ra} = Outer trough height
 B_{Ri} = Inner trough width
 B_{Ra} = Outer trough width

! $H_{Ri} \geq 2 \cdot h_a$
 $B_{Ri} \geq B_a + 4$

- = Guide trough
- = Glide bar
- = Installation set "Basic"
- = C-profile

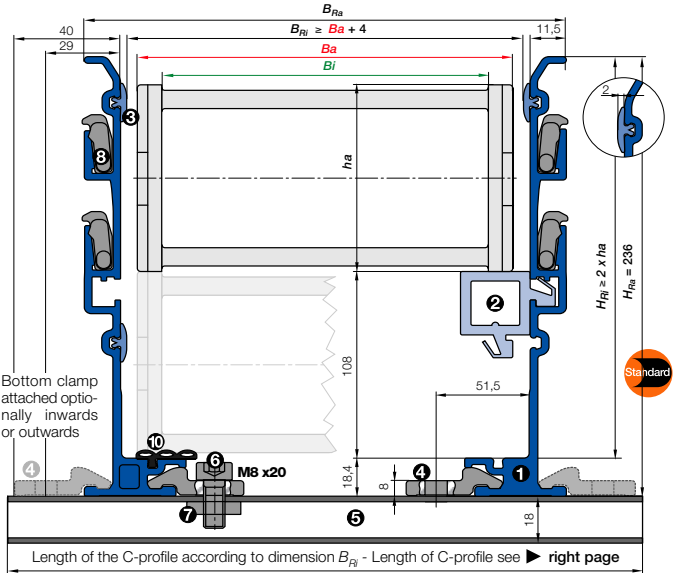

- **Components, trough "Basic":** ① Trough side parts, aluminum, 2 m ② Glide bar, plastic, 2 m ③ Glide strips, plastic, 2 m (without glide strips on request) ⑩ Optional: Silencer profile, rubber
- **Components, installation set "Basic":** ④ Bottom clamp, aluminum ⑤ C-profile, steel galvanized ⑥ Screw M8 x 20 ⑦ Sliding nut M8 ⑧ Interface connector, plastic

Basic version: Aluminum "SuperTrough" components

Complete guide trough sets - description	Part No.	Weight	kg
① Set of 2 trough side parts, incl. glide strips, without glide bars, 2 m section	975.30.SL	= 14,0	kg
① Set of 2 trough side parts, incl. glide strips, with glide bars, 2 m section	975.31.SL	= 16,6	kg
1 Installation set "Basic" without C-profile	960.50	= 0,08	kg
1 Installation set "Basic" with C-profile	960.50.		
Single parts - description			
⑥ 1 Glide strip, individual, 2 m section	75.01	= 0,06	kg
⑩ 1 Silencer profile, rubber, individual, 2 m section	75.68.H		
④ 1 Bottom clamp, individual	75.50	= 0,04	kg
⑧ 1 Interface connector, individual	75.60		
⑥ 1 Screw M8 x 20, individual	MAT 0040445		
⑦ 1 Sliding nut M8, individual	MAT 0040413		
② 1 Glide bar, individual, 2 m section	83.79	= 1,30	kg
⑤ 1 C-profile, individual	92.52.	= 0,90	kg/m



Calculation - travel center mounted

Half travel length, rounded down to full 2 m sections = X m guide trough length without glide bars + X m guide trough length with glide bars + installation sets "Basic" (number of trough pieces + 1)

Supplement Part No. with the indicated C-profile-length-index.
Example: 960.50.200
 C-profile length-index for your chosen trough inner width B_{Ri} ▶ see table on the right or the respective page for chosen series



Fixed end module - A quick fix for mounting the stationary end of an E-Chain* ▶ page 9.16



Order example: Length of travel 30 m - Center mounted for Series 5050.30.300.0 with $B_{Ri} = 345$

Guide trough set (set of 2 trough side parts, incl. glide strips) **without** glide bar
Order text: 16 m guide trough without glide bar (8 x 2 m sections) Part No. 975.30.SL

Guide trough set (set of 2 trough side parts, incl. glide strips) **with** glide bar
Order text: 16 m guide trough with glide bar (8 x 2 m sections) Part No. 975.31.SL

Installation set "Basic" complete (guide trough-sets + 1)
Order text: 17 installation sets "Basic" Part No. 960.50.425

Module for the fixed end
Order text: 1 set Part No. 975.80

Option: For an additional noise dampening with silencer profile, please add Index A Example:
 Part No. 975.30.SLA

Lengths of C-profile for Basic version - Bottom clamp attached optionally inwards or outwards

E4.80/H4.80/R4.80			5050/5150/R9850			15050/15150/R19850			E6.80		
E4.80.05.200.0			5050.05.200.0			15050.05.200.0			E6.80.30.300.0		
B_{Ri} [mm]	Part No. attached inwards	Part No. attached outwards	B_{Ri} [mm]	Part No. attached inwards	Part No. attached outwards	B_{Ri} [mm]	Part No. attached inwards	Part No. attached outwards	B_{Ri} [mm]	Part No. attached inwards	Part No. attached outwards
.05	104	* 960.50.225	.05	104	* 960.50.225	.05	84	* 960.50.200	.05	104	* 960.50.225
.06	119	* 960.50.250	.06	119	* 960.50.250	.06	99	* 960.50.225	.06	119	* 960.50.250
.07	129	* 960.50.250	.07	129	* 960.50.250	.07	109	* 960.50.225	.07	129	* 960.50.250
.08	141	960.50.200 960.50.275	.08	141	960.50.200 960.50.275	.08	121	* 960.50.250	.08	141	960.50.200 960.50.275
.10	154	960.50.225 960.50.275	.10	154	960.50.225 960.50.275	.10	134	* 960.50.250	.10	154	960.50.225 960.50.275
.11	167	960.50.225 960.50.300	.11	167	960.50.225 960.50.300	.11	146	960.50.200 960.50.275	.11	167	960.50.225 960.50.300
.12	179	960.50.250 960.50.300	.12	179	960.50.250 960.50.300	.12	159	960.50.225 960.50.275	.12	179	960.50.250 960.50.300
.13	192	960.50.250 960.50.325	.13	192	960.50.250 960.50.325	.13	171	960.50.225 960.50.300	.13	192	960.50.250 960.50.325
.15	204	960.50.275 960.50.325	.15	204	960.50.275 960.50.325	.15	184	960.50.250 960.50.300	.15	204	960.50.275 960.50.325
.16	217	960.50.275 960.50.350	.16	217	960.50.275 960.50.350	.16	196	960.50.250 960.50.325	.16	217	960.50.275 960.50.350
.17	229	960.50.300 960.50.350	.17	229	960.50.300 960.50.350	.17	209	960.50.275 960.50.325	.17	229	960.50.300 960.50.350
.18	242	960.50.300 960.50.375	.18	242	960.50.300 960.50.375	.18	221	960.50.275 960.50.350	.18	242	960.50.275 960.50.375
.20	254	960.50.325 960.50.375	.20	254	960.50.325 960.50.375	.20	234	960.50.300 960.50.350	.20	254	960.50.325 960.50.375
.21	267	960.50.325 960.50.400	.21	267	960.50.325 960.50.400	.21	246	960.50.300 960.50.375	.21	267	960.50.325 960.50.400
.22	279	960.50.350 960.50.400	.22	279	960.50.350 960.50.400	.22	259	960.50.325 960.50.375	.22	279	960.50.350 960.50.400
.23	292	960.50.350 960.50.425	.23	292	960.50.350 960.50.425	.23	271	960.50.325 960.50.400	.23	292	960.50.350 960.50.425
.25	304	960.50.375 960.50.425	.25	304	960.50.375 960.50.425	.25	284	960.50.350 960.50.400	.25	304	960.50.375 960.50.425
.26	317	960.50.375 960.50.450	.26	317	960.50.375 960.50.450	.26	296	960.50.350 960.50.425	.26	317	960.50.375 960.50.450
.27	329	960.50.400 960.50.450	.27	329	960.50.400 960.50.450	.27	309	960.50.375 960.50.425	.27	329	960.50.400 960.50.450
.28	342	960.50.400 960.50.475	.28	342	960.50.400 960.50.475	.28	321	960.50.375 960.50.450	.28	342	960.50.400 960.50.475
.30	354	960.50.425 960.50.475	.30	354	960.50.425 960.50.475	.30	334	960.50.400 960.50.450	.30	354	960.50.425 960.50.475
.31	367	960.50.425 960.50.500	.31	367	960.50.425 960.50.500	.31	346	960.50.400 960.50.475	.31	367	960.50.425 960.50.500
.32	379	960.50.450 960.50.500	.32	379	960.50.450 960.50.500	.32	359	960.50.425 960.50.475	.32	379	960.50.450 960.50.500
.33	392	960.50.450 960.50.525	.33	392	960.50.450 960.50.525	.33	371	960.50.425 960.50.500	.33	392	960.50.450 960.50.525
.35	404	960.50.475 960.50.525	.35	404	960.50.475 960.50.525	.35	384	960.50.450 960.50.500	.35	404	960.50.475 960.50.525
.36	417	960.50.475 960.50.550	.36	417	960.50.475 960.50.550	.36	396	960.50.450 960.50.525	.36	417	960.50.475 960.50.550
.37	429	960.50.500 960.50.550	.37	429	960.50.500 960.50.550	.37	409	960.50.475 960.50.525	.37	429	960.50.500 960.50.550
.38	442	960.50.500 960.50.575	.38	442	960.50.500 960.50.575	.38	421	960.50.475 960.50.550	.38	442	960.50.500 960.50.575
.40	454	960.50.525 960.50.575	.40	454	960.50.525 960.50.575	.40	434	960.50.500 960.50.550	.40	454	960.50.525 960.50.575
.41	467	960.50.525 960.50.600	.41	467	960.50.525 960.50.600	.41	446	960.50.500 960.50.575	.41	467	960.50.525 960.50.600
.42	479	960.50.550 960.50.600	.42	479	960.50.550 960.50.600	.42	459	960.50.525 960.50.575	.42	479	960.50.550 960.50.600
.43	492	960.50.550 960.50.625	.43	492	960.50.550 960.50.625	.43	471	960.50.525 960.50.600	.43	492	960.50.550 960.50.625
.45	504	960.50.575 960.50.625	.45	504	960.50.575 960.50.625	.45	484	960.50.550 960.50.600	.45	504	960.50.575 960.50.625
.46	517	960.50.575 960.50.650	.46	517	960.50.575 960.50.650	.46	496	960.50.550 960.50.625	.46	517	960.50.575 960.50.650
.47	529	960.50.600 960.50.650	.47	529	960.50.600 960.50.650	.47	509	960.50.575 960.50.625	.47	529	960.50.600 960.50.650
.48	542	960.50.600 960.50.675	.48	542	960.50.600 960.50.675	.48	521	960.50.575 960.50.650	.48	542	960.50.600 960.50.675
.50	554	960.50.625 960.50.675	.50	554	960.50.625 960.50.675	.50	534	960.50.600 960.50.650	.50	554	960.50.625 960.50.675
.51	567	960.50.625 960.50.700	.51	567	960.50.625 960.50.700	.51	546	960.50.600 960.50.675	.51	567	960.50.625 960.50.700
.52	579	960.50.650 960.50.700	.52	579	960.50.650 960.50.700	.52	559	960.50.625 960.50.675	.52	579	960.50.650 960.50.700
.53	592	960.50.650 960.50.725	.53	592	960.50.650 960.50.725	.53	571	960.50.625 960.50.700	.53	592	960.50.650 960.50.725
.55	604	960.50.675 960.50.725	.55	604	960.50.675 960.50.725	.55	584	960.50.650 960.50.700	.55	604	960.50.675 960.50.725
.60	654	960.50.725 960.50.775	.60	654	960.50.725 960.50.775	.60	634	960.50.700 960.50.750	.60	654	960.50.725 960.50.775

*upon request

"Heavy Duty" Version | Installation set Part No. 975.50

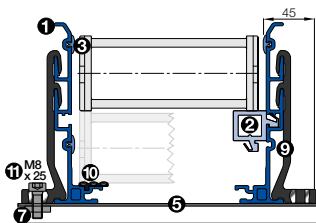

- Components, trough "Heavy Duty": ① Trough side parts, aluminum, 2 m ② Glide bar, plastic, 2 m ③ Glide strips, plastic 2 m (without glide strips on request) ⑩ Optional: Silencer profile, rubber
- Components, installation set "Heavy Duty": ⑤ C-profile, steel galvanized ⑦ Sliding nut M8 ⑧ Heavy duty bracket, aluminum ⑪ Screw M8 x 25

Note: Dimensions similar to Basic version!
Exception: Heavy duty bracket, see drawing



- = Guide trough
- = Glide bar
- = Installation set "Heavy duty"
- = C-profile

Insert for the installation set "Heavy-Duty": **975.50.XXX** instead of **960.50.XXX** on the right column "attached outwards"
"Heavy Duty" installation set Part No. 975.50. 200

! The inner width of the guide through and the length of the C-Profile of the assembly kit can differ according to the bracket you choose. Please call us!



For the following
E-Chains®/E-Tubes:

System E4 Series

- 5050HD/R9850HD

We especially recommend for the igus® E4/4 series 5050 HD (Heavy Duty) this trough system. Structurally identical with trough 975.30.SL yet with special HD-installation set, suitable for ambitious applications.

- B_a = Outer E-Chain® width
 - B_i = Inner E-Chain® width
 - h_a = E-Chain® outer height
 - H_{Ri} = Inner trough height
 - H_{Ra} = Outer trough height
 - B_{Ri} = Inner trough width
 - B_{Ra} = Outer trough width
- ▶ depends on dim. B_a

! $H_{Ri} \geq 2 \cdot h_a$
■ $B_{Ri} \geq B_a + 4$

- = Guide trough
- = Glide bar
- = Installation set
- = C-profile



Calculation - travel
center mounted

Half travel length, rounded down to full 2 m sections = X m guide trough length without glide bars + X m guide trough length with glide bars + installation sets (number of trough pieces + 1)

Supplement Part No. with the indicated C-profile-length-index.
Example: 975.50.200

C-profile length-index for your chosen trough inner width B_{Ri} ▶ see table on the right or the respective page for chosen series

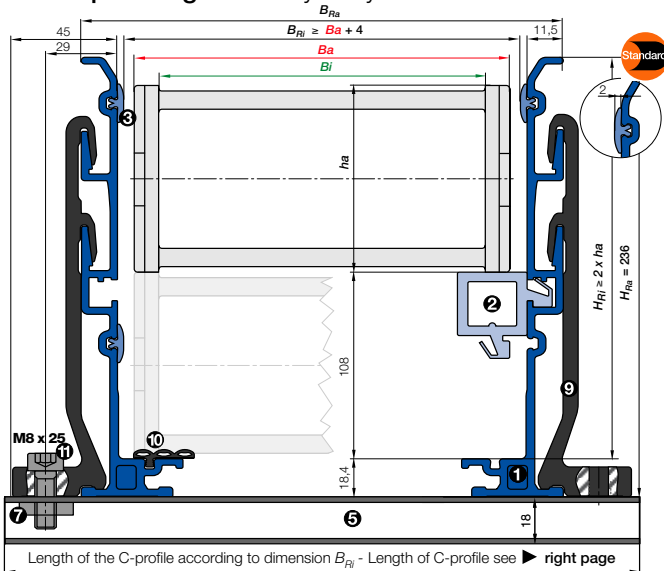

- Components, trough "Heavy Duty": ① Trough side parts, aluminum, 2 m ② Glide bar, plastic, 2 m ③ Glide strips, plastic, 2 m (without glide strips on request) ⑩ Optional: Silencer profile, rubber ● Components, installation set "Heavy Duty": ⑤ C-profile, steel galvanized ⑦ Sliding nut M8 ⑨ Heavy duty bracket, aluminum ⑪ Screw M8 x 25

Heavy Duty version: Aluminum "SuperTrough" components

Complete guide trough sets - description	Part No.	Weight	kg
① Set of 2 trough side parts, incl. glide strips, without glide bars, 2 m section	975.30.SL	≈ 14,0	kg
② Set of 2 trough side parts, incl. glide strips, with glide bars, 2 m section	975.31.SL	≈ 16,6	kg
③ 1 Installation set "Heavy Duty" without C-profile	975.50	≈ 0,53	kg
1 Installation set "Heavy Duty" with C-profile	975.50.□		
Single parts - description			
⑥ 1 Glide strip, individual, 2 m section	75.01	≈ 0,06	kg
⑩ 1 Silencer profile, rubber, individual, 2 m section	75.68.H		
⑪ 1 Screw M8 x 25, individual	MAT 0040445		
⑦ 1 Sliding nut M8, individual	MAT 0040413		
② 1 Glide bar, individual, 2 m section	83.79	≈ 1,30	kg
⑤ 1 C-profile, individual	92.52.□	≈ 0,90	kg/m



Order example: Length of travel 30 m -
Center mounted for Series 5050HD.10.250.0 with $B_{Ri} = 975.30.SL$

Guide trough set (set of 2 trough side parts, incl. glide strips) without glide bar		
Order text: 16 m guide trough without glide bar (8 x 2 m sections)	Part No.	975.31.SL
Guide trough set (set of 2 trough side parts, incl. glide strips) with glide bar		
Order text: 16 m guide trough with glide bar (8 x 2 m sections)	Part No.	975.50.300
Installation set "Heavy Duty" complete (guide trough-sets + 1)		
Order text: 17 installation sets "Heavy Duty"	Part No.	975.80
Module for the fixed end		
Order text: 1 set	Part No.	975.30.SLA
Option: For an additional noise dampening with silencer profile, please add Index A Example:	Part No.	

Lengths of C-profile

5050HD/R9850HD

5050HD.30.300.0

B_{R1} [mm]	Part No. assembled
.05 114	974.50.250
.06 129	974.50.250
.07 139	974.50.275
.08 152	974.50.275
.10 164	974.50.300
.11 176	974.50.300
.12 189	974.50.325
.13 201	974.50.325
.15 214	974.50.350
.16 226	974.50.350
.17 239	974.50.375
.18 251	974.50.375
.20 264	974.50.400
.21 276	974.50.400
.22 289	974.50.425
.23 301	974.50.425
.25 314	974.50.450
.26 326	974.50.450
.27 339	974.50.475
.28 351	974.50.475
.30 364	974.50.500
.31 376	974.50.500
.32 389	974.50.525
.33 401	974.50.525
.35 414	974.50.550
.36 426	974.50.550
.37 439	974.50.575
.38 451	974.50.575
.40 464	974.50.600
.41 476	974.50.600
.42 489	974.50.625
.43 501	974.50.625
.45 514	974.50.650
.46 526	974.50.650
.47 539	974.50.675
.48 551	974.50.675
.50 564	974.50.700
.51 576	974.50.700
.52 589	974.50.725
.53 601	974.50.725
.55 614	974.50.750
.60 664	974.50.800

! The inner width of the guide through and the length of the C-Profile of the assembly kit can differ according to the bracket you choose. Please call us!



Steel Guide Troughs

Steel guide trough - very stable and rugged for heavy duty applications

If the igus® installation sets are used, the guide troughs are particularly easy to assemble. All the steel guide troughs are constructed according to the same basic principle. On the following pages, you will find information about dimensions, weights and accessories according to the trough size. You will find all necessary design data to stipulate the assembly width on. All sizes use a common C-profile on which the guide parts are assembled. The assembly brackets used vary in height only.

- Easy assembly with installation set
- Big range, two piece design, adjustable to E-Chain® width
- Available in galvanized steel and stainless steel
- Glide bar made of PE

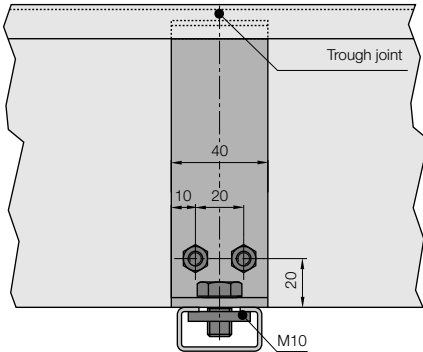

Side view of trough joint. All the dimensions, apart from the height, apply to all sizes

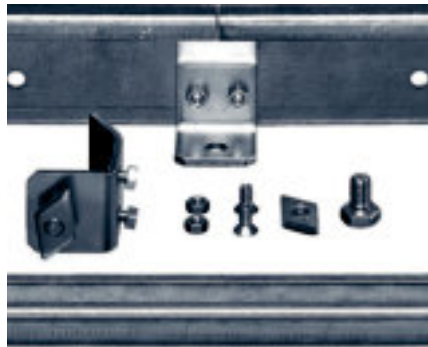

Installation set for joint and attachment surface connections secure connection without misalignment and without welding

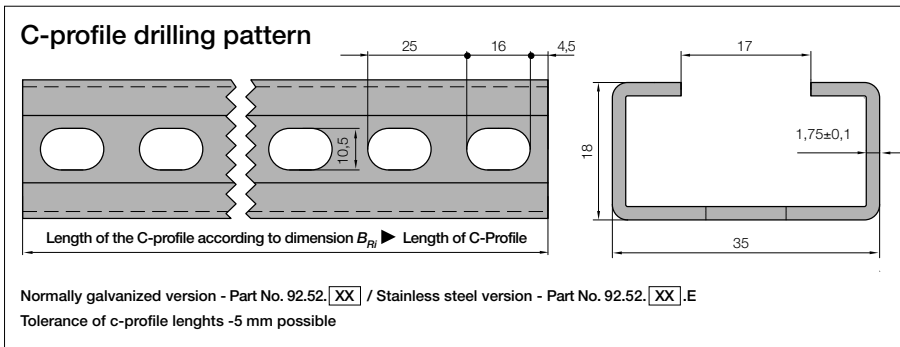



For the following
E-Chains®/E-Tubes:

System E2 Series

● 2500

● 255

System E6 Series

● E6.29/R6.29

E2 medium classic

● 250 classic



Fixed end module

Quick installation of the mounting brackets due to the prepared bores

► page 9.62

- B_a = Outer E-Chain® width
- B_i = Inner E-Chain® width
- h_a = E-Chain® outer height
- H_{Ri} = Inner trough height
- H_{Ra} = Outer trough height
- B_{Ri} = Inner trough width ► depends on dim. B_a
- B_{Ra} = Outer trough width
- n_{Mon} = Number of installation sets (left/right)
- n_{Ri} = Number of trough sets (left/right)
- ! $H_{Ri} \geq 2 \cdot h_a$
- ! $B_{Ri} \geq B_a + 5$
- = Guide trough
- = Glide bar
- = Installation set
- = C-profile

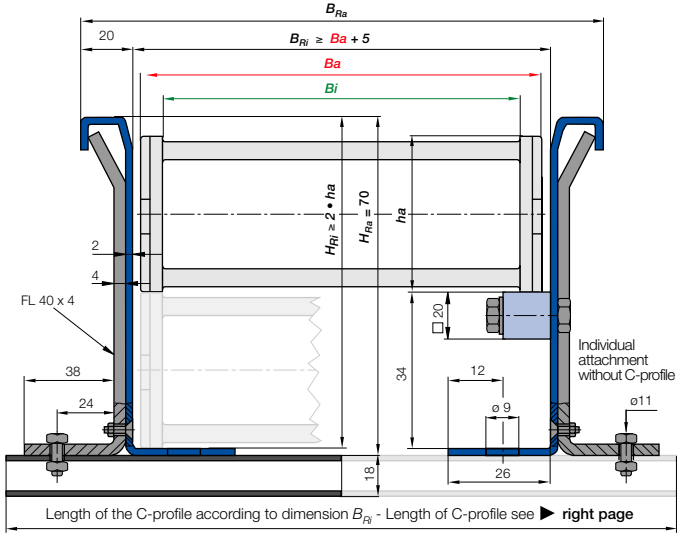

Steel Guide Trough components - Sets and single parts

Complete guide trough sets - description	Part No.	Weight	kg
Set of 2 trough side parts without glide bars, 2 m section	92.30	≈ 7,60 kg	
Set of 2 trough side parts with glide bars, 2 m section	92.31	≈ 9,60 kg	
1 Installation set with C-profile	92.50. <input type="text"/>		
1 Installation set without C-profile	92.50	≈ 0,34 kg	
Single parts - description			
1 glide bar, individual, each 2 m	92.01	≈ 0,75 kg	
1 glide bar, individual, each 2 m + 11 screw sets	92.20	≈ 0,98 kg	
11 screw sets for 2 m sections	92.21	≈ 0,23 kg	
1 Clamping bracket, individual	92.51	≈ 0,12 kg	
1 Countersunk-head screw M6 x 14, individual	92.53		
1 Hexagon nut M6, individual	92.54		
1 Hexagon-head screw M10 x 16, individual	92.55		
1 Glide nut M10, individual	92.56		
1 C-profile, individual	92.52. <input type="text"/>	≈ 0,90 kg/m	

Supplement Part No. with the indicated C-profile-length-index. Example: 92.50.175

C-profile-length-index for your chosen trough inner width B_{Ri} ► right table

Trough side parts also available in stainless steel. Please add index "E" to the Part No. 92.30.E

Principle sketch: Number of installation sets which have to be installed

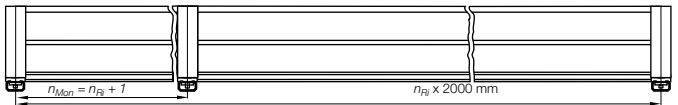

Calculation - travel center mounted

Half travel length, rounded down to full 2 m sections = X m guide trough length without glide bars + X m guide trough length with glide bars + installation sets (number of trough pieces + 1)



Order example: Length of travel 30 m - Center mounted for Series 2500.05.200.0 with $B_{Ri} = 78$

Guide trough-set of 2 trough side parts, without glide bars:	
16 m Guide trough = 8 x 2 m sections (without glide bars)	Part No. 92.30
Guide trough-set of 2 trough side parts, with assembled glide bars:	
16 m Guide trough = 8 x 2 m sections (with glide bars)	Part No. 92.31
Installation sets complete (Guide trough-sets + 1)	
17 Installation sets (with C-profile)	Part No. 92.50.200

Part No. Installation set: Steel Guide Trough with C-profile (in dependence of the width)

2500

2500.~~03~~.200.0

B_{Rl} [mm]	Part No. Installation set
.02 46	*
.03 59	92.50.175
.05 78	92.50.200
.07 98	92.50.225
.09 110	92.50.225
.10 124	92.50.250
.12 146	92.50.275

255

255.~~03~~.200.0

B_{Rl} [mm]	Part No. Installation set
.03 59	92.50.175
.05 78	92.50.200
.07 98	92.50.225
.10 124	92.50.250

E6.29/R6.29

E6.29.~~040~~.100.0

B_{Rl} [mm]	Part No. Installation set
.030 51	*
.040 61	92.50.175
.050 71	92.50.200
.060 81	92.50.200
.070 91	92.50.200
.080 101	92.50.225
.090 111	92.50.225
.100 121	92.50.250
.110 131	92.50.250
.120 141	92.50.250

*upon request



For the following
E-Chains®/E-Tubes:

System E2 Series

- 2700

System E2 Tubes Series

- R58

E2 medium classic

- 27 classic



Fixed end module

Quick installation of the mounting brackets due to the prepared bores

► page 9.62

- B_a = Outer E-Chain® width
- B_i = Inner E-Chain® width
- h_a = E-Chain® outer height
- H_{Ri} = Inner trough height
- H_{Ra} = Outer trough height
- B_{Ri} = Inner trough width ► depends on dim. B_a
- B_{Ra} = Outer trough width
- n_{Mon} = Number of installation sets (left/right)
- n_{Ri} = Number of trough sets (left/right)
- $H_{Ri} \geq 2 \cdot h_a$**
- $B_{Ri} \geq B_a + 5$**
- = Guide trough
- = Glide bar
- = Installation set
- = C-profile

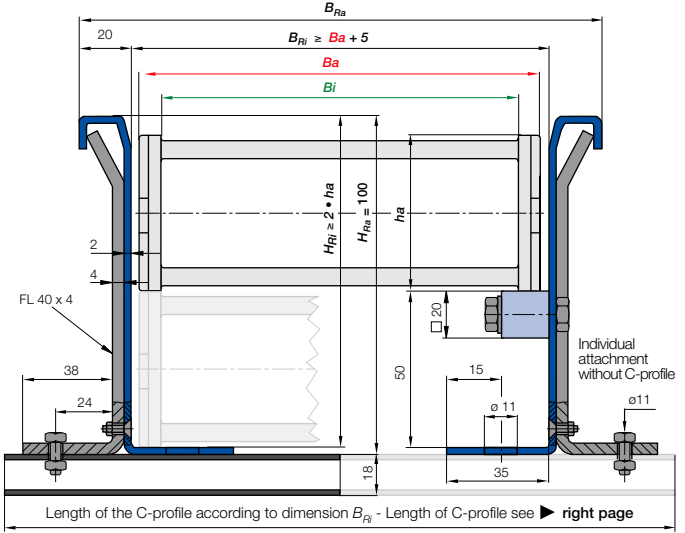

Steel Guide Trough components - Sets and single parts

Complete guide trough sets - description	Part No.	Weight	kg
Set of 2 trough side parts without glide bars, 2 m section	95.30	≈ 10,00	kg
Set of 2 trough side parts with glide bars, 2 m section	95.31	≈ 12,00	kg
1 Installation set with C-profile	95.50. <input type="text"/>		
1 Installation set without C-profile	95.50	≈ 0,41	kg
Single parts - description			
1 glide bar, individual, each 2 m	92.01	≈ 0,75	kg
1 glide bar, individual, each 2 m + 11 screw sets	92.20	≈ 0,98	kg
11 screw sets for 2 m sections	92.21	≈ 0,23	kg
1 Clamping bracket, individual	95.51	≈ 0,16	kg
1 Countersunk-head screw M6 x 14, individual	92.53		
1 Hexagon nut M6, individual	92.54		
1 Hexagon-head screw M10 x 16, individual	92.55		
1 Glide nut M10, individual	92.56		
1 C-profile, individual	92.52. <input type="text"/>	≈ 0,90	kg/m

Supplement Part No. with the indicated C-profile-length-index. **Example:** 95.50.

C-profile-length-index for your chosen trough inner width B_{Ri} ► **right table**

Trough side parts also available in stainless steel. Please add index "E" to the **Part No. 95.30.E**

Principle sketch: Number of installation sets which have to be installed

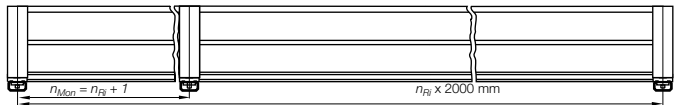

Calculation - travel center mounted

Half travel length, rounded down to full 2 m sections = **X m guide trough length without glide bars** + **X m guide trough length with glide bars** + **installation sets** (number of trough pieces + 1)



Order example: Length of travel 30 m - Center mounted for Series 2700.05.200.0 with $B_{Ri} = 71$

Guide trough-set of 2 trough side parts, without glide bars:	
16 m Guide trough = 8 x 2 m sections (without glide bars)	Part No. 95.30
Guide trough-set of 2 trough side parts, with assembled glide bars:	
16 m Guide trough = 8 x 2 m sections (with glide bars)	Part No. 95.31
Installation sets complete (Guide trough-sets + 1)	
17 Installation sets (with C-profile)	Part No. 95.50. <input type="text"/>

Part No. Installation set: Steel Guide Trough with C-profile (in dependance of the width)

2700

2700.05.200.0

	B_{Rl} [mm]	Part No. Installation set
.05	71	95.50.200
.06	86	95.50.200
.07	96	95.50.225
.09	111	95.50.225
.10	121	95.50.250
.12	146	95.50.275
.15	171	95.50.300
.17	199	95.50.325

R58

58.050.200.0

	B_{Rl} [mm]	Part No. Installation set
.050	71	95.50.200
.075	96	95.50.225
.100	121	95.50.250
.125	146	95.50.275
.150	171	95.50.300
.175	196	95.50.325
.200	221	95.50.350



For the following
E-Chains®/E-Tubes:

System E4 Series

- E4.28/R4.28
- 220/R760

- E6.35



Fixed end module

Quick installation of the mounting brackets due to the prepared bores

► page 9.62

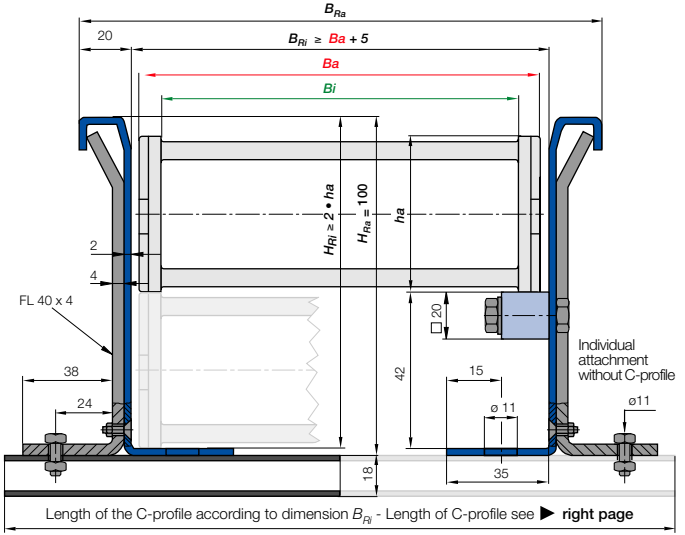

- Ba** = Outer E-Chain® width
- Bi** = Inner E-Chain® width
- ha** = E-Chain® outer height
- H_{Ri}** = Inner trough height
- H_{fa}** = Outer trough height
- B_{Ri}** = Inner trough width ► depends on dim. *Ba*
- B_{Ra}** = Outer trough width
- n_{Mon}** = Number of installation sets (left/right)
- n_{Ri}** = Number of trough sets (left/right)
- **H_{Ri} ≥ 2 • ha**
- **B_{Ri} ≥ Ba + 5**
- = Guide trough
- = Glide bar
- = Installation set
- = C-profile

Steel Guide Trough components - Sets and single parts

Complete guide trough sets - description	Part No.	Weight	kg
Set of 2 trough side parts without glide bars, 2 m section	99.30	≈ 10,00 kg	
Set of 2 trough side parts with glide bars, 2 m section	99.31	≈ 12,00 kg	
1 Installation set with C-profile	95.50. <input type="text"/>		
1 Installation set without C-profile	95.50.	≈ 0,41 kg	
Single parts - description			
1 glide bar, individual, each 2 m	92.01	≈ 0,75kg	
1 glide bar, individual, each 2 m + 11 screw sets	92.20	≈ 0,98 kg	
11 screw sets for 2 m sections	92.21	≈ 0,23 kg	
1 Clamping bracket, individual	95.51	≈ 0,16 kg	
1 Countersunk-head screw M6 x 14, individual	92.53		
1 Hexagon nut M6, individual	92.54		
1 Hexagon-head screw M10 x 16, individual	92.55		
1 Glide nut M10, individual	92.56		
1 C-profile, individual	92.52. <input type="text"/>	≈ 0,90 kg/m	

Supplement Part No. with the indicated C-profile-length-index. **Example: 95.50. 200**

C-profile-length-index for your chosen trough inner width **B_{Ri}** ► [right table](#)

Trough side parts also available in stainless steel. Please add index "E" to the **Part No. 99.30.E**

Principle sketch: Number of installation sets which have to be installed

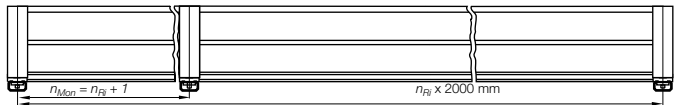

Calculation - travel
center mounted

Half travel length, rounded down to full 2 m sections = **X m guide trough length without glide bars** + **X m guide trough length with glide bars** + **installation sets** (number of trough pieces + 1)



Order example: Length of travel 30 m - Center mounted for Series E4.28.050.200.0 with B_{Ri} = 75

Guide trough-set of 2 trough side parts, without glide bars:	16 m Guide trough = 8 x 2 m sections (without glide bars)	Part No. 99.30
Guide trough-set of 2 trough side parts, with assembled glide bars:	16 m Guide trough = 8 x 2 m sections (with glide bars)	Part No. 99.31
Installation sets complete (Guide trough-sets + 1)	17 Installation sets (with C-profile)	Part No. 95.50. <u>200</u>

Part No. Installation set: Steel Guide Trough with C-profile (in dependance of the width)

E4.28/R4.28

E4.28.**040**.200.0

B_{Rl} [mm]	Part No. Installation set
.040 65	*
.050 75	95.50.200
.062 87	95.50.200
.070 95	95.50.200
.075 100	95.50.225
.087 112	95.50.225
.100 125	95.50.250
.125 150	95.50.275
.150 175	95.50.300
.175 200	95.50.325
.200 225	95.50.350
.225 250	95.50.375
.250 275	95.50.400
.275 300	95.50.425
.300 325	95.50.450

220/R760

220.**040**.200.0

B_{Rl} [mm]	Part No. Installation set
.040 65	*
.050 75	95.50.200
.062 87	95.50.200
.070 95	95.50.200
.075 100	95.50.225
.087 112	95.50.225
.100 125	95.50.250
.125 150	95.50.275
.150 175	95.50.300
.175 200	95.50.325
.200 225	95.50.350
.225 250	95.50.375
.250 275	95.50.400
.275 300	95.50.425
.300 325	95.50.450

E6.35

E6.35.**100**.055.0

B_{Rl} [mm]	Part No. Installation set
.030 55	*
.040 65	*
.050 75	95.50.200
.060 85	95.50.200
.070 95	95.50.200
.080 105	95.50.225
.090 115	95.50.225
.100 125	95.50.250
.110 135	95.50.250
.120 145	95.50.250

*upon request



For the following
E-Chains®/E-Tubes:

System E4 Series

- E4.32/H4.32/R4.32
- 280/290/R770
- 2828/2928/R7728

System E6 Series

- E6.40/R6.40



Fixed end module

Quick installation of the mounting brackets due to the prepared bores

► page 9.62

- B_a = Outer E-Chain® width
- B_i = Inner E-Chain® width
- h_a = E-Chain® outer height
- H_{Ri} = Inner trough height
- H_{Ra} = Outer trough height
- B_{Ri} = Inner trough width ► depends on dim. B_a
- B_{Ra} = Outer trough width
- n_{Mon} = Number of installation sets (left/right)
- n_{Ri} = Number of trough sets (left/right)
- ! $H_{Ri} \geq 2 \cdot h_a$
- ! $B_{Ri} \geq B_a + 5$
- = Guide trough
- = Glide bar
- = Installation set
- = C-profile

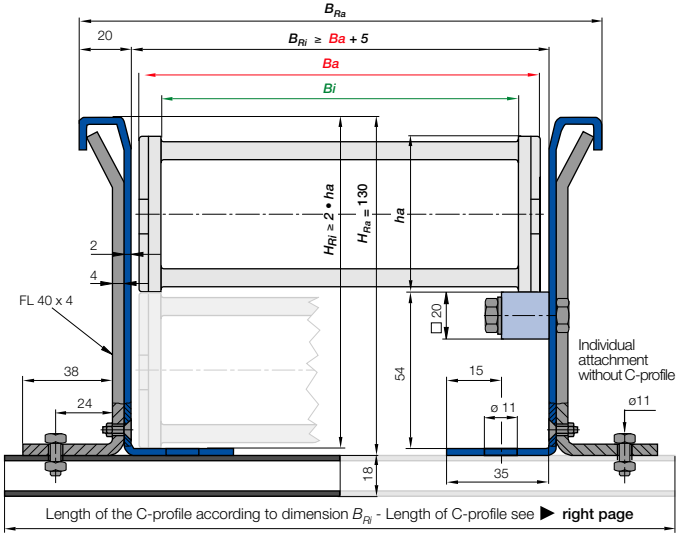

Steel Guide Trough components - Sets and single parts

Complete guide trough sets - description	Part No.	Weight	kg
Set of 2 trough side parts without glide bars, 2 m section	97.30	≈ 11,80 kg	
Set of 2 trough side parts with glide bars, 2 m section	97.31	≈ 13,60 kg	
1 Installation set with C-profile	93.50. <input type="text"/>		
1 Installation set without C-profile	93.50	≈ 0,49 kg	
Single parts - description			
1 glide bar, individual, each 2 m	92.01	≈ 0,75 kg	
1 glide bar, individual, each 2 m + 11 screw sets	92.20	≈ 0,98 kg	
11 screw sets for 2 m sections	92.21	≈ 0,23 kg	
1 Clamping bracket, individual	93.51	≈ 0,20 kg	
1 Countersunk-head screw M6 x 14, individual	92.53		
1 Hexagon nut M6, individual	92.54		
1 Hexagon-head screw M10 x 16, individual	92.55		
1 Glide nut M10, individual	92.56		
1 C-profile, individual	92.52. <input type="text"/>	≈ 0,90 kg/m	

Supplement Part No. with the indicated C-profile-length-index. Example: 93.50.

C-profile-length-index for your chosen trough inner width B_{Ri} ► right table

Trough side parts also available in stainless steel. Please add index "E" to the Part No. 97.30.E

Principle sketch: Number of installation sets which have to be installed

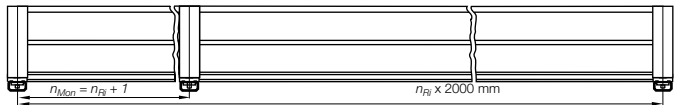

Calculation - travel center mounted

Half travel length, rounded down to full 2 m sections = X m guide trough length without glide bars + X m guide trough length with glide bars + installation sets (number of trough pieces + 1)



Order example: Length of travel 30 m - Center mounted for Series 2828.05.200.0 with $B_{Ri} = 79$

Guide trough-set of 2 trough side parts, without glide bars:	
16 m Guide trough = 8 x 2 m sections (without glide bars)	Part No. 97.30
Guide trough-set of 2 trough side parts, with assembled glide bars:	
16 m Guide trough = 8 x 2 m sections (with glide bars)	Part No. 97.31
Installation sets complete (Guide trough-sets + 1)	
17 Installation sets (with C-profile)	Part No. 93.50. <input type="text"/>



For the following
E-Chains®/E-Tubes:

System E2 Series

- 3500

System E2 Tubes Series

- R68

System E4 Series

- E4.42/H4.42/R4.42

- 380/390/R780

- 3838/3938/R7838

System E6 Series

- E6.52/R6.52

E2 medium classic

- 350 classic



Fixed end module

Quick installation of the mounting brackets due to the prepared bores

► page 9.62

- B_a = Outer E-Chain® width
- B_i = Inner E-Chain® width
- h_a = E-Chain® outer height
- H_{Ri} = Inner trough height
- H_{Ra} = Outer trough height
- B_{Ri} = Inner trough width ► depends on dim. B_a
- B_{Ra} = Outer trough width
- n_{Mon} = Number of installation sets (left/right)
- n_{Ri} = Number of trough sets (left/right)

- ! $H_{Ri} \geq 2 \cdot h_a$
- ! $B_{Ri} \geq B_a + 5$
- = Guide trough
- = Guide bar
- = Installation set
- = C-profile

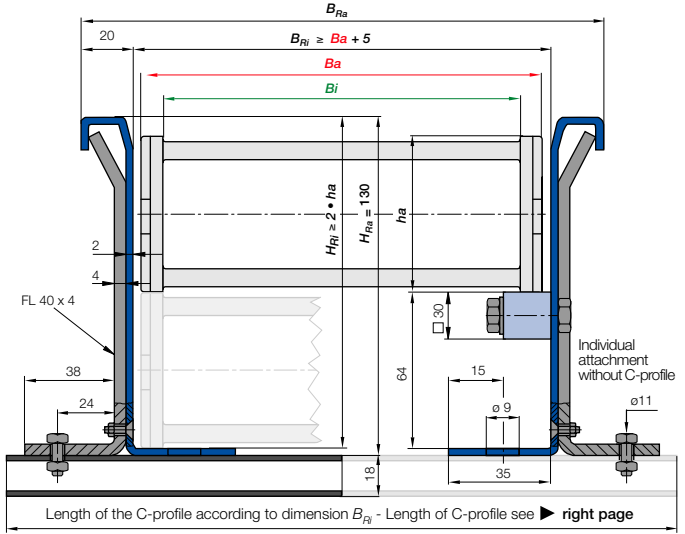

Steel Guide Trough components - Sets and single parts

Complete guide trough sets - description

Complete guide trough sets - description	Part No.	Weight	kg
Set of 2 trough side parts without glide bars, 2 m section	93.30	≈ 11,80 kg	
Set of 2 trough side parts with glide bars, 2 m section	93.31	≈ 16,20 kg	
1 Installation set with C-profile	93.50. <input type="text"/>		
1 Installation set without C-profile	93.50	≈ 0,49 kg	

Single parts - description

1 glide bar, individual, each 2 m	93.01	≈ 1,68 kg	
1 glide bar, individual, each 2 m + 11 screw sets	93.20	≈ 2,22 kg	
11 screw sets for 2 m sections	93.21	≈ 0,54 kg	
1 Clamping bracket, individual	93.51	≈ 0,20 kg	
1 Countersunk-head screw M6 x 14, individual	92.53		
1 Hexagon nut M6, individual	92.54		
1 Hexagon-head screw M10 x 16, individual	92.55		
1 Glide nut M10, individual	92.56		
1 C-profile, individual	92.52. <input type="text"/>	≈ 0,90 kg/m	

Supplement Part No. with the indicated C-profile-length-index. Example: 93.50.

C-profile-length-index for your chosen trough inner width B_{Ri} ► right table

Trough side parts also available in stainless steel. Please add index "E" to the Part No. 93.30.E

Principle sketch: Number of installation sets which have to be installed

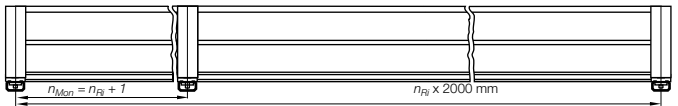

Calculation - travel
center mounted

Half travel length, rounded down to full 2 m sections = **X m guide trough length without glide bars** + **X m guide trough length with glide bars** + **installation sets** (number of trough pieces + 1)



Order example: Length of travel 30 m - Center mounted for Series 3500.075.200.0 with $B_{Ri} = 100$

Guide trough-set of 2 trough side parts, without glide bars:	
16 m Guide trough = 8 x 2 m sections (without glide bars)	Part No. 93.30
Guide trough-set of 2 trough side parts, with assembled glide bars:	
16 m Guide trough = 8 x 2 m sections (with glide bars)	Part No. 93.31
Installation sets complete (Guide trough-sets + 1)	
17 Installation sets (with C-profile)	Part No. 93.50. <input type="text"/>

Part No. Installation set: Steel Guide Trough with C-profile (in dependence of the width)

3500
3500.050.200.0

B_{Ri} [mm]	Part No. Installation set
.050 75	93.50.200
.075 100	93.50.225
.100 125	93.50.250
.115 140	93.50.250
.125 150	93.50.275
.150 175	93.50.300
.175 200	93.50.325
.200 225	93.50.350
.225 250	93.50.375
.250 275	93.50.400

E4.42/H4.42/R4.42
E4.42.07.200.0

B_{Ri} [mm]	Part No. Installation set
.05 81	93.50.200
.06 99	93.50.225
.07 106	93.50.225
.087 119	93.50.250
.10 131	93.50.250
.11 139	93.50.250
.112 144	93.50.275
.12 156	93.50.275
.137 169	93.50.300
.15 181	93.50.300
.162 194	93.50.325
.17 199	93.50.325
.18 206	93.50.325
.187 219	93.50.350
.20 231	93.50.350
.212 244	93.50.375
.23 256	93.50.375
.237 269	93.50.400
.25 281	93.50.400
.262 294	93.50.425
.28 306	93.50.425
.29 319	93.50.450
.30 331	93.50.450
.312 344	93.50.475
.325 356	93.50.475
.337 369	93.50.500
.350 381	93.50.500
.362 394	93.50.525
.375 407	93.50.525
.387 419	93.50.550
.400 431	93.50.550

380/390/R780
390.07.200.0

B_{Ri} [mm]	Part No. Installation set
.05 81	93.50.200
.06 99	93.50.225
.07 106	93.50.225
.087 119	93.50.250
.10 131	93.50.250
.11 139	93.50.250
.112 144	93.50.275
.12 156	93.50.275
.137 169	93.50.300
.15 181	93.50.300
.162 194	93.50.325
.17 199	93.50.325
.18 206	93.50.325
.187 219	93.50.350
.20 231	93.50.350
.212 244	93.50.375
.23 256	93.50.375
.237 269	93.50.400
.25 281	93.50.400
.262 294	93.50.425
.28 306	93.50.425
.29 319	93.50.450
.30 331	93.50.450
.312 344	93.50.475
.325 356	93.50.475
.337 369	93.50.500
.350 381	93.50.500
.362 394	93.50.525
.375 407	93.50.525
.387 419	93.50.550
.400 431	93.50.550

3838/3938/R7838
3838.05.200.0

B_{Ri} [mm]	Part No. Installation set
.05 82	93.50.200
.06 100	93.50.225
.07 107	93.50.225
.087 120	93.50.250
.10 132	93.50.250
.11 140	93.50.250
.112 145	93.50.275
.12 157	93.50.275
.137 170	93.50.300
.15 182	93.50.300
.162 195	93.50.325
.17 200	93.50.325
.18 207	93.50.325
.187 220	93.50.350
.20 232	93.50.350
.212 245	93.50.375
.23 257	93.50.375
.237 270	93.50.400
.25 282	93.50.400
.262 295	93.50.425
.28 307	93.50.425
.29 320	93.50.450
.30 332	93.50.450
.312 345	93.50.475
.325 357	93.50.475
.337 370	93.50.500
.350 382	93.50.500
.362 395	93.50.525
.375 407	93.50.525
.387 420	93.50.550
.400 432	93.50.550

E6.52/R6.52
E6.52.040.200.0

B_{Ri} [mm]	Part No. Installation set
.040 69	*
.050 79	93.50.200
.062 91	93.50.200
.070 99	93.50.225
.075 104	93.50.225
.087 116	93.50.225
.100 129	93.50.250
.125 154	93.50.275
.150 179	93.50.300
.175 204	93.50.325
.200 229	93.50.350
.225 254	93.50.375
.250 279	93.50.400
.275 304	93.50.425
.300 329	93.50.450

R68
68.050.200.0

B_{Ri} [mm]	Part No. Installation set
.050 73	93.50.200
.075 98	93.50.225
.100 123	93.50.250
.115 138	93.50.250
.125 148	93.50.275
.150 173	93.50.300
.175 198	93.50.325
.200 223	93.50.350
.225 248	93.50.375
.250 273	93.50.400

*upon request

! The inner width of the guide through and the length of the C-Profile of the assembly kit can differ according to the bracket you choose. Please call us!



For the following
E-Chains®/E-Tubes:

System E4 Series

- E4.56/H4.56/R4.56
- 400/410/R880
- 4040/4140/R8840
- 4040HD/R8840HD
- 14040/14140/R18840
- 14240/14340

- E6.62

System E6 Series



Fixed end module

Quick installation of the mounting brackets due to the prepared bores

► page 9.62

- B_a = Outer E-Chain® width
- B_i = Inner E-Chain® width
- h_a = E-Chain® outer height
- H_{Ri} = Inner trough height
- H_{Ra} = Outer trough height
- B_{Ri} = Inner trough width ► depends on dim. B_a
- B_{Ra} = Outer trough width
- n_{Mon} = Number of installation sets (left/right)
- n_{Ri} = Number of trough sets (left/right)
- ▶ $H_{Ri} \geq 2 \cdot h_a$
- ▶ $B_{Ri} \geq B_a + 5$
- = Guide trough
- = Glide bar
- = Installation set
- = C-profile

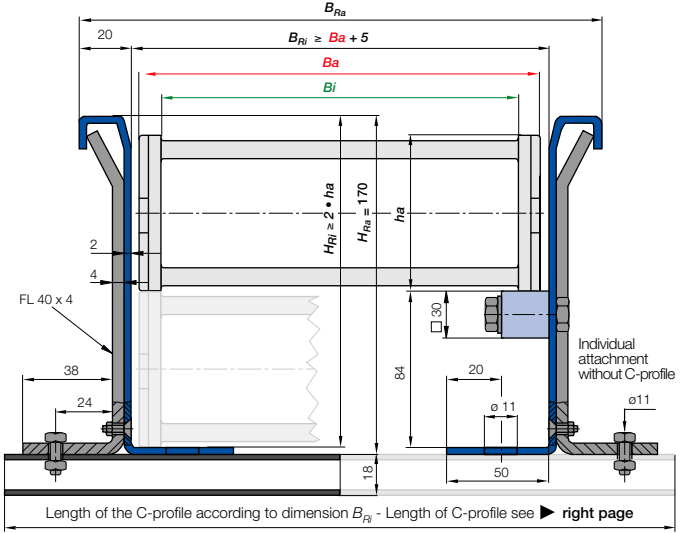

Steel Guide Trough components - Sets and single parts

Complete guide trough sets - description	Part No.	Weight	kg
Set of 2 trough side parts without glide bars, 2 m section	94.30	≈ 14,70 kg	
Set of 2 trough side parts with glide bars, 2 m section	94.31	≈ 19,00 kg	
1 Installation set with C-profile	94.50		
1 Installation set without C-profile	94.50	≈ 0,58 kg	
Single parts - description			
1 glide bar, individual, each 2 m	93.01	≈ 1,68 kg	
1 glide bar, individual, each 2 m + 11 screw sets	93.20	≈ 2,22 kg	
11 screw sets for 2 m sections	93.21	≈ 0,54 kg	
1 Clamping bracket, individual	94.51	≈ 0,25 kg	
1 Countersunk-head screw M6 x 14, individual	92.53		
1 Hexagon nut M6, individual	92.54		
1 Hexagon-head screw M10 x 16, individual	92.55		
1 Glide nut M10, individual	92.56		
1 C-profile, individual	92.52	≈ 0,90 kg/m	

Supplement Part No. with the indicated C-profile-length-index. Example: 94.50. 225

C-profile-length-index for your chosen trough inner width B_{Ri} ► [right table](#)

Trough side parts also available in stainless steel. Please add index "E" to the Part No. 94.30.E

Principle sketch: Number of installation sets which have to be installed

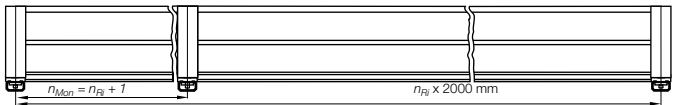

Calculation - travel center mounted

Half travel length, rounded down to full 2 m sections = **X m guide trough length without glide bars + X m guide trough length with glide bars + installation sets** (number of trough pieces + 1)



Order example: Length of travel 30 m - Center mounted for Series E4.56.06.200.0 with $B_{Ri} = 104$

Guide trough-set of 2 trough side parts, without glide bars:	16 m Guide trough = 8 x 2 m sections (without glide bars)	Part No. 94.30
Guide trough-set of 2 trough side parts, with assembled glide bars:	16 m Guide trough = 8 x 2 m sections (with glide bars)	Part No. 94.31
Installation sets complete (Guide trough-sets + 1)	17 Installation sets (with C-profile)	Part No. 94.50. 225

Part No. Installation set: Steel Guide Trough with C-profile (in dependence of the width)

E4.56/H4.56/R4.56		400/410/R880		4040/4140/R8840		4040HD/R8840HD		14040/14140/R18840		14240/14340		E6.62	
E4.56.10.200.0		400.10.200.0		4040.05.200.0		4040HD.05.200.0		14040.05.200.0		14240.05.200.0		E6.62.05.200.0	
B_{Ri} [mm]	Part No. Installation set	B_{Ri} [mm]	Part No. Installation set	B_{Ri} [mm]	Part No. Installation set	B_{Ri} [mm]	Part No. Installation set	B_{Ri} [mm]	Part No. Installation set	B_{Ri} [mm]	Part No. Installation set	B_{Ri} [mm]	Part No. Installation set
.05	89 *	.05	89 *	.05	91 *	.05	109 94.50.225	.05	81 *	.05	81 *	.05	91 *
.06	104 94.50.225	.06	104 94.50.225	.06	106 94.50.225	.06	124 94.50.250	.06	96 *	.06	99 *	.06	109 94.50.225
.07	114 94.50.225	.07	114 94.50.225	.07	116 94.50.225	.07	134 94.50.250	.07	106 94.50.225	.07	106 94.50.225	.07	116 94.50.225
.10	139 94.50.250	.10	139 94.50.250	.10	141 94.50.250	.10	159 94.50.275	.10	131 94.50.250	.087	119 94.50.250	.087	128 94.50.250
.11	152 94.50.275	.11	152 94.50.275	.11	154 94.50.275	.11	171 94.50.300	.11	144 94.50.275	.10	131 94.50.250	.10	141 94.50.250
.12	164 94.50.275	.12	164 94.50.275	.12	166 94.50.275	.12	184 94.50.300	.12	156 94.50.275	.11	139 94.50.250	.11	149 94.50.275
.13	177 94.50.300	.13	177 94.50.300	.13	179 94.50.300	.13	196 94.50.325	.13	169 94.50.300	.112	144 94.50.275	.112	153 94.50.275
.15	189 94.50.300	.15	189 94.50.300	.15	191 94.50.300	.15	209 94.50.325	.15	181 94.50.300	.12	156 94.50.275	.12	166 94.50.275
.16	202 94.50.325	.16	202 94.50.325	.16	204 94.50.325	.16	221 94.50.350	.16	194 94.50.325	.137	169 94.50.300	.137	178 94.50.300
.17	214 94.50.325	.17	214 94.50.325	.17	216 94.50.325	.17	234 94.50.350	.17	206 94.50.325	.15	181 94.50.300	.15	191 94.50.300
.18	227 94.50.350	.18	227 94.50.350	.18	229 94.50.350	.18	246 94.50.375	.18	219 94.50.350	.162	194 94.50.325	.162	203 94.50.325
.20	239 94.50.350	.20	239 94.50.350	.20	241 94.50.350	.20	259 94.50.375	.20	231 94.50.350	.17	199 94.50.325	.17	209 94.50.325
.21	252 94.50.375	.21	252 94.50.375	.21	254 94.50.375	.21	271 94.50.400	.21	244 94.50.375	.18	206 94.50.325	.18	216 94.50.325
.22	264 94.50.375	.22	264 94.50.375	.22	266 94.50.375	.22	284 94.50.400	.22	256 94.50.375	.187	219 94.50.350	.187	228 94.50.350
.23	277 94.50.400	.23	277 94.50.400	.23	279 94.50.400	.23	296 94.50.425	.23	269 94.50.400	.20	231 94.50.350	.20	241 94.50.350
.25	289 94.50.400	.25	289 94.50.400	.25	291 94.50.400	.25	309 94.50.425	.25	281 94.50.400	.212	244 94.50.375	.212	253 94.50.375
.26	302 94.50.425	.26	302 94.50.425	.26	304 94.50.425	.26	321 94.50.450	.26	294 94.50.425	.23	256 94.50.375	.23	266 94.50.375
.27	314 94.50.425	.27	314 94.50.425	.27	316 94.50.425	.27	334 94.50.450	.27	306 94.50.425	.237	269 94.50.400	.237	278 94.50.400
.28	327 94.50.450	.28	327 94.50.450	.28	329 94.50.450	.28	346 94.50.475	.28	319 94.50.450	.25	281 94.50.400	.25	291 94.50.400
.30	339 94.50.450	.30	339 94.50.450	.30	341 94.50.450	.30	359 94.50.475	.30	331 94.50.450	.262	294 94.50.425	.262	303 94.50.425
.31	352 94.50.475	.31	352 94.50.475	.31	354 94.50.475	.31	371 94.50.500	.31	344 94.50.475	.28	306 94.50.425	.28	316 94.50.425
.32	364 94.50.475	.32	364 94.50.475	.32	366 94.50.475	.32	384 94.50.500	.32	356 94.50.475	.29	319 94.50.450	.29	328 94.50.450
.33	377 94.50.500	.33	377 94.50.500	.33	379 94.50.500	.33	396 94.50.525	.33	369 94.50.500	.30	331 94.50.450	.30	341 94.50.450
.35	389 94.50.500	.35	389 94.50.500	.35	391 94.50.500	.35	409 94.50.525	.35	381 94.50.500	.312	344 94.50.475	.312	353 94.50.475
.36	402 94.50.525	.36	402 94.50.525	.36	404 94.50.525	.36	421 94.50.550	.36	394 94.50.525	.325	356 94.50.475	.325	366 94.50.475
.37	414 94.50.525	.37	414 94.50.525	.37	416 94.50.525	.37	434 94.50.550	.37	406 94.50.525	.337	369 94.50.500	.337	378 94.50.500
.38	427 94.50.550	.38	427 94.50.550	.38	429 94.50.550	.38	446 94.50.575	.38	419 94.50.550	.350	381 94.50.500	.350	391 94.50.500
.40	439 94.50.550	.40	439 94.50.550	.40	441 94.50.550	.40	459 94.50.575	.40	431 94.50.550	.362	394 94.50.525	.362	403 94.50.525
.41	452 94.50.575	.41	452 94.50.575	.41	454 94.50.575	.41	471 94.50.600	.41	444 94.50.575	.375	406 94.50.525	.375	416 94.50.525
.42	464 94.50.575	.42	464 94.50.575	.42	466 94.50.575	.42	484 94.50.600	.42	456 94.50.575	.384	419 94.50.550	.384	428 94.50.550
.43	477 94.50.600	.43	477 94.50.600	.43	479 94.50.600	.43	496 94.50.625	.43	469 94.50.600	.400	431 94.50.550	.400	441 94.50.550
.45	489 94.50.600	.45	489 94.50.600	.45	491 94.50.600	.45	509 94.50.625	.45	481 94.50.600				
.46	502 94.50.625	.46	502 94.50.625	.46	504 94.50.625	.46	521 94.50.650	.46	494 94.50.625				
.47	514 94.50.625	.47	514 94.50.625	.47	516 94.50.625	.47	534 94.50.650	.47	506 94.50.625				
.48	527 94.50.650	.48	527 94.50.650	.48	529 94.50.650	.48	546 94.50.675	.48	519 94.50.650				
.50	539 94.50.650	.50	539 94.50.650	.50	541 94.50.650	.50	559 94.50.675	.50	531 94.50.650				
.51	552 94.50.675	.51	552 94.50.675	.51	554 94.50.675	.51	571 94.50.700	.51	544 94.50.675				
.52	564 94.50.675	.52	564 94.50.675	.52	566 94.50.675	.52	584 94.50.700	.52	556 94.50.675				
.53	577 94.50.700	.53	577 94.50.700	.53	579 94.50.700	.53	596 94.50.725	.53	569 94.50.700				
.55	589 94.50.700	.55	589 94.50.700	.55	591 94.50.700	.55	609 94.50.725	.55	581 94.50.700				
.60	639 94.50.750	.60	639 94.50.750	.60	641 94.50.750	.60	659 94.50.775	.60	631 94.50.750				

*upon request



Trough (Part No. 94.30 and 94.31)
with reinforced mounting angles for
very rugged and extreme applications

! The inner width of the guide through and the length of the C-Profile of the assembly kit can differ according to the bracket you choose. Please call us!



For the following
E-Chains®/E-Tubes:

System E4 Series

- E4.80/H4.80/R4.80
- 5050/5150/R9850
- 5050HD/R9850HD
- 15050/15150/R19850

System E6 Series

- E6.80



Fixed end module

Quick installation of the mounting brackets due to the prepared bores

► page 9.62

- B_a = Outer E-Chain® width
- B_i = Inner E-Chain® width
- h_a = E-Chain® outer height
- H_{Ri} = Inner trough height
- H_{Ra} = Outer trough height
- B_{Ri} = Inner trough width ► depends on dim. B_a
- B_{Ra} = Outer trough width
- n_{Mon} = Number of installation sets (left/right)
- n_{Ri} = Number of trough sets (left/right)
- ! $H_{Ri} \geq 2 \cdot h_a$
- ! $B_{Ri} \geq B_a + 5$
- = Guide trough
- = Glide bar
- = Installation set
- = C-profile

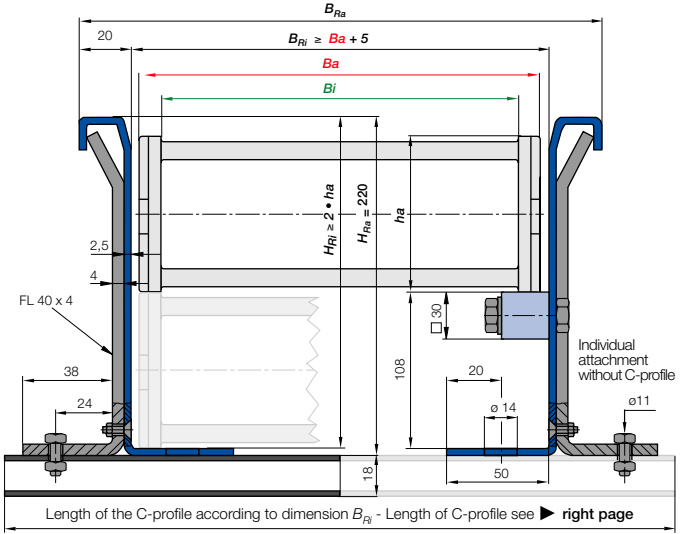

Steel Guide Trough components - Sets and single parts

Complete guide trough sets - description	Part No.	Weight	kg
Set of 2 trough side parts without glide bars, 2 m section	96.30	≈ 22,80 kg	
Set of 2 trough side parts with glide bars, 2 m section	96.31	≈ 27,20 kg	
1 Installation set with C-profile	96.50		
1 Installation set without C-profile	96.50	≈ 0,72 kg	
Single parts - description			
1 glide bar, individual, each 2 m	93.01	≈ 1,68 kg	
1 glide bar, individual, each 2 m + 11 screw sets	93.20	≈ 2,22 kg	
11 screw sets for 2 m sections	93.21	≈ 0,54 kg	
1 Clamping bracket, individual	96.51	≈ 0,31 kg	
1 Countersunk-head screw M6 x 14, individual	92.53		
1 Hexagon nut M6, individual	92.54		
1 Hexagon-head screw M10 x 16, individual	92.55		
1 Glide nut M10, individual	92.56		
1 C-profile, individual	92.52	≈ 0,90 kg/m	

Supplement Part No. with the indicated C-profile-length-index. **Example: 96.50.225**

C-profile-length-index for your chosen trough inner width B_{Ri} ► **right table**

Trough side parts also available in stainless steel. Please add index "E" to the **Part No. 96.30.E**

Principle sketch: Number of installation sets which have to be installed

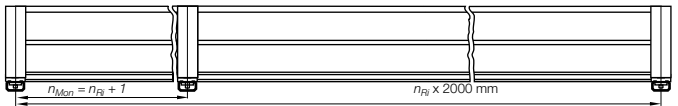

Calculation - travel center mounted

Half travel length, rounded down to full 2 m sections = **X m guide trough length without glide bars + X m guide trough length with glide bars + installation sets** (number of trough pieces + 1)



Order example: Length of travel 30 m - Center mounted for Series 5050.05.200.0 with $B_{Ri} = 105$

Guide trough-set of 2 trough side parts, without glide bars:	16 m Guide trough = 8 x 2 m sections (without glide bars)	Part No. 96.30
Guide trough-set of 2 trough side parts, with assembled glide bars:	16 m Guide trough = 8 x 2 m sections (with glide bars)	Part No. 96.31
Installation sets complete (Guide trough-sets + 1)	17 Installation sets (with C-profile)	Part No. 96.50.225

Part No. Installation set: Steel Guide Trough with C-profile (in dependance of the width)

E4.80/H4.80/R4.80			5050/5150/R9850			5050HD/R9850HD			15050/15150/R19850			E6.80		
E4.80.10.200.0			5050.10.200.0			5050HD.10.200.0			15050.07.200.0			E6.80.05.200.0		
B_R [mm]	Part No.	Installation set	B_R [mm]	Part No.	Installation set	B_R [mm]	Part No.	Installation set	B_R [mm]	Part No.	Installation set	B_R [mm]	Part No.	Installation set
.05	105	96.50.225	.05	105	96.50.225	.05	115	96.50.225	.05	85	*	.05	105	96.50.225
.06	120	96.50.250	.06	120	96.50.250	.06	130	96.50.250	.06	100	*	.06	120	96.50.250
.07	130	96.50.250	.07	130	96.50.250	.07	140	96.50.250	.07	110	96.50.225	.07	130	96.50.250
.10	155	96.50.275	.10	155	96.50.275	.10	165	96.50.275	.10	135	96.50.250	.10	155	96.50.275
.11	168	96.50.300	.11	168	96.50.300	.11	177	96.50.300	.11	148	96.50.275	.11	167	96.50.300
.12	180	96.50.300	.12	180	96.50.300	.12	190	96.50.300	.12	160	96.50.275	.12	180	96.50.300
.13	193	96.50.325	.13	193	96.50.325	.13	202	96.50.325	.13	173	96.50.300	.13	192	96.50.325
.15	205	96.50.325	.15	205	96.50.325	.15	215	96.50.325	.15	185	96.50.300	.15	205	96.50.325
.16	218	96.50.350	.16	218	96.50.350	.16	227	96.50.350	.16	198	96.50.325	.16	217	96.50.350
.17	230	96.50.350	.17	230	96.50.350	.17	240	96.50.350	.17	210	96.50.325	.17	230	96.50.350
.18	243	96.50.375	.18	243	96.50.375	.18	252	96.50.375	.18	223	96.50.350	.18	242	96.50.375
.20	255	96.50.375	.20	255	96.50.375	.20	265	96.50.375	.20	235	96.50.350	.20	255	96.50.375
.21	268	96.50.400	.21	268	96.50.400	.21	277	96.50.400	.21	248	96.50.375	.21	267	96.50.400
.22	280	96.50.400	.22	280	96.50.400	.22	290	96.50.400	.22	260	96.50.375	.22	280	96.50.400
.23	293	96.50.425	.23	293	96.50.425	.23	302	96.50.425	.23	273	96.50.400	.23	292	96.50.425
.25	305	96.50.425	.25	305	96.50.425	.25	315	96.50.425	.25	285	96.50.400	.25	305	96.50.425
.26	318	96.50.450	.26	318	96.50.450	.26	327	96.50.450	.26	298	96.50.425	.26	317	96.50.450
.27	330	96.50.450	.27	330	96.50.450	.27	340	96.50.450	.27	310	96.50.425	.27	330	96.50.450
.28	343	96.50.475	.28	343	96.50.475	.28	352	96.50.475	.28	323	96.50.450	.28	342	96.50.475
.30	355	96.50.475	.30	355	96.50.475	.30	365	96.50.475	.30	335	96.50.450	.30	355	96.50.475
.31	368	96.50.500	.31	368	96.50.500	.31	377	96.50.500	.31	348	96.50.475	.31	367	96.50.500
.32	380	96.50.500	.32	380	96.50.500	.32	390	96.50.500	.32	360	96.50.475	.32	380	96.50.500
.33	393	96.50.525	.33	393	96.50.525	.33	402	96.50.525	.33	373	96.50.500	.33	392	96.50.525
.35	405	96.50.525	.35	405	96.50.525	.35	415	96.50.525	.35	385	96.50.500	.35	405	96.50.525
.36	418	96.50.550	.36	418	96.50.550	.36	427	96.50.550	.36	398	96.50.525	.36	417	96.50.550
.37	430	96.50.550	.37	430	96.50.550	.37	440	96.50.550	.37	410	96.50.525	.37	430	96.50.550
.38	443	96.50.575	.38	443	96.50.575	.38	452	96.50.575	.38	423	96.50.550	.38	442	96.50.575
.40	455	96.50.575	.40	455	96.50.575	.40	465	96.50.575	.40	435	96.50.550	.40	455	96.50.575
.41	468	96.50.600	.41	468	96.50.600	.41	477	96.50.600	.41	448	96.50.575	.41	470	96.50.600
.42	480	96.50.600	.42	480	96.50.600	.42	490	96.50.600	.42	460	96.50.575	.42	480	96.50.600
.43	493	96.50.625	.43	493	96.50.625	.43	502	96.50.625	.43	473	96.50.600	.43	492	96.50.625
.45	505	96.50.625	.45	505	96.50.625	.45	515	96.50.625	.45	485	96.50.600	.45	505	96.50.625
.46	518	96.50.650	.46	518	96.50.650	.46	527	96.50.650	.46	498	96.50.625	.46	517	96.50.650
.47	530	96.50.650	.47	530	96.50.650	.47	540	96.50.650	.47	510	96.50.625	.47	530	96.50.650
.48	543	96.50.675	.48	543	96.50.675	.48	552	96.50.675	.48	523	96.50.650	.48	542	96.50.675
.50	555	96.50.675	.50	555	96.50.675	.50	565	96.50.675	.50	535	96.50.650	.50	555	96.50.675
.51	568	96.50.700	.51	568	96.50.700	.51	577	96.50.700	.51	548	96.50.675	.51	567	96.50.700
.52	580	96.50.700	.52	580	96.50.700	.52	590	96.50.700	.52	560	96.50.675	.52	580	96.50.700
.53	593	96.50.725	.53	593	96.50.725	.53	602	96.50.725	.53	573	96.50.700	.53	592	96.50.725
.55	605	96.50.725	.55	605	96.50.725	.55	615	96.50.725	.55	585	96.50.700	.55	605	96.50.725
.60	655	96.50.775	.60	655	96.50.775	.60	665	96.50.775	.60	635	96.50.750	.60	655	96.50.775

*upon request



Trough (Part No. 96.30 and 96.31)
with reinforced mounting angles for
very rugged and extreme applications

! The inner width of the guide through and the length of the C-Profile of the assembly kit can differ according to the bracket you choose. Please call us!



For the following
E-Chains®/E-Tubes:

System E4 Series

- 600/601/R608
- 640
- 1640/R1608



Fixed end module

Quick installation of the mounting brackets due to the prepared bores

► page 9.62

- B_a = Outer E-Chain® width
- B_i = Inner E-Chain® width
- h_a = E-Chain® outer height
- H_{Ri} = Inner trough height
- H_{Ra} = Outer trough height
- B_{Ri} = Inner trough width ► depends on dim. B_a
- B_{Ra} = Outer trough width
- n_{Mon} = Number of installation sets (left/right)
- n_{Ri} = Number of trough sets (left/right)
- ! $H_{Ri} \geq 2 \cdot h_a$
- ! $B_{Ri} \geq B_a + 5$
- = Guide trough
- = Glide bar
- = Installation set
- = C-profile

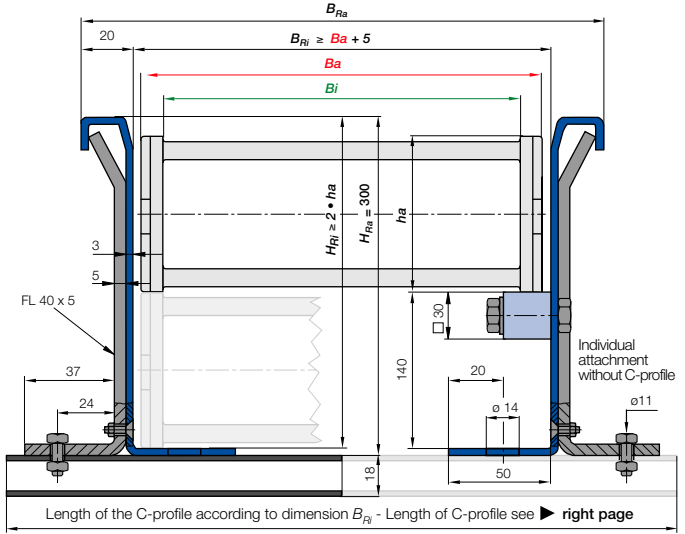

Steel Guide Trough components - Sets and single parts

Complete guide trough sets - description

Complete guide trough sets - description	Part No.	Weight	kg
Set of 2 trough side parts without glide bars, 2 m section	98.30	≈ 34,60 kg	
Set of 2 trough side parts with glide bars, 2 m section	98.31	≈ 39,00 kg	
1 Installation set with C-profile	98.50 <input type="text"/>		
1 Installation set without C-profile	98.50	≈ 1,16 kg	

Single parts - description

1 glide bar, individual, each 2 m	93.01	≈ 1,68 kg	
1 glide bar, individual, each 2 m + 11 screw sets	93.20	≈ 2,22 kg	
11 screw sets for 2 m sections	93.21	≈ 0,54 kg	
1 Clamping bracket, individual	98.51	≈ 0,52 kg	
1 Countersunk-head screw M8 x 20, individual	92.05		
1 Hexagon nut M8, individual	92.04		
1 Hexagon-head screw M10 x 16, individual	92.55		
1 Glide nut M10, individual	92.56		
1 C-profile, individual	92.52 <input type="text"/>	≈ 0,90 kg/m	

Supplement Part No. with the indicated C-profile-length-index. **Example: 98.50.375**

C-profile-length-index for your chosen trough inner width B_{Ri} ► **right table**

Trough side parts also available in stainless steel. Please add index "E" to the **Part No. 98.30.E**

Principle sketch: Number of installation sets which have to be installed

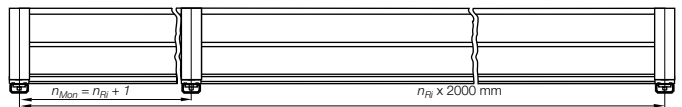

Calculation - travel center mounted

Half travel length, rounded down to full 2 m sections = **X m guide trough length without glide bars + X m guide trough length with glide bars + installation sets** (number of trough pieces + 1)



Order example: Length of travel 30 m - Center mounted for Series 600.20.200.0 with $B_{Ri} = 257$

Guide trough-set of 2 trough side parts, **without** glide bars:

16 m Guide trough = 8 x 2 m sections (without glide bars)	Part No.	
Guide trough-set of 2 trough side parts, with assembled glide bars:		98.30
16 m Guide trough = 8 x 2 m sections (with glide bars)	Part No.	
Installation sets complete (Guide trough-sets + 1)		98.31
17 Installation sets (with C-profile)	Part No.	
		98.50.375



For the following
E-Chains®/E-Tubes:

System E4 Series

- 800
- 840

Guide troughs with reinforced brackets for the largest igus® E-Chains® Series 800 and 840. Especially designed for crane and off-shore applications



Fixed end module

Quick installation of the mounting brackets due to the prepared bores

▶ page 9.62

- B_a = Outer E-Chain® width
- B_i = Inner E-Chain® width
- h_a = E-Chain® outer height
- H_{Ri} = Inner trough height
- H_{Ra} = Outer trough height
- B_{Ri} = Inner trough width ▶ depends on dim. B_a
- B_{Ra} = Outer trough width
- n_{Mon} = Number of installation sets (left/right)
- n_{Ri} = Number of trough sets (left/right)
- $H_{Ri} \geq 2 \cdot h_a$**
- $B_{Ri} \geq B_a + 5$**
- = Guide trough
- = Glide bar
- = Installation set
- = C-profile

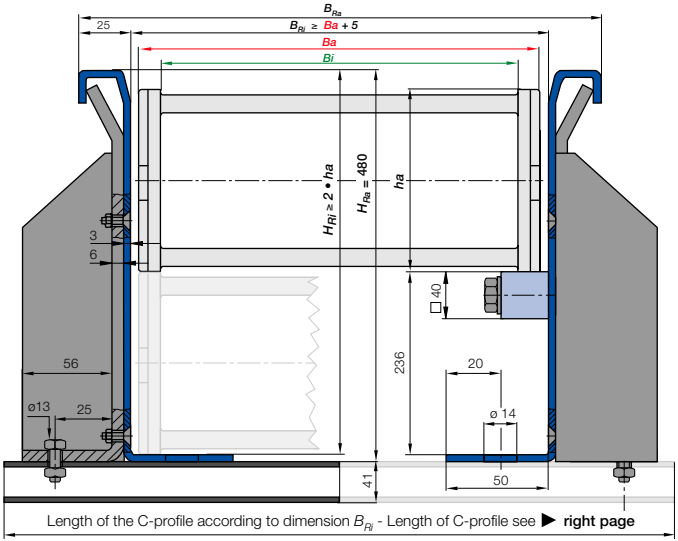

Steel Guide Trough components - Sets and single parts

Complete guide trough sets - description	Part No.	Weight	kg
Set of 2 trough side parts without glide bars, 2 m section	90.30	≈ 53,40 kg	
Set of 2 trough side parts with glide bars, 2 m section	90.31	≈ 59,40 kg	
1 Installation set with C-profile	90.50		
1 Installation set without C-profile	90.50	≈ 0,41 kg	
Single parts - description			
1 glide bar, individual, each 2 m	90.01	≈ 3,00 kg	
1 glide bar, individual, each 2 m + 11 screw sets	90.20	≈ 3,50 kg	
11 screw sets for 2 m sections	90.21	≈ 0,50 kg	
1 Clamping bracket, individual	90.51	≈ 2,75 kg	
2 Countersunk-head screws M8 x 25, individual	92.53		
2 Hexagon nuts M8, individual	92.54		
1 Hexagon-head screw M12 x 30, individual	92.55		
1 Glide nut M12, individual	92.56		
1 C-profile, individual	92.52	≈ 0,90 kg/m	

Supplement Part No. with the indicated C-profile-length-index. Example: 90.50.200

C-profile-length-index for your chosen trough inner width B_{Ri} ▶ right table

Trough side parts also available in stainless steel. Please add index "E" to the Part No. 90.30.E

Principle sketch: Number of installation sets which have to be installed

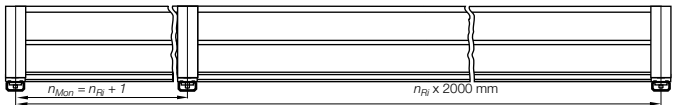

Calculation - travel center mounted

Half travel length, rounded down to full 2 m sections = **X m guide trough length without glide bars + X m guide trough length with glide bars + installation sets** (number of trough pieces + 1)



Order example: Length of travel 30 m - Center mounted for Series 800.20.325.0 with $B_{Ri} = 265$

Guide trough-set of 2 trough side parts, without glide bars:	16 m Guide trough = 8 x 2 m sections (without glide bars)	Part No. 90.30
Guide trough-set of 2 trough side parts, with assembled glide bars:	16 m Guide trough = 8 x 2 m sections (with glide bars)	Part No. 90.31
Installation sets complete (Guide trough-sets + 1)	17 Installation sets (with C-profile)	Part No. 90.50.450

Part No. Installation set: Steel Guide Trough with C-profile (in dependance of the width)

800

800.20.325.0

B_{Rl} [mm]	Part No. Installation set
.20	265 90.50.450
.25	315 90.50.500
.30	365 90.50.550
.32	390 90.50.575
.35	415 90.50.600
.40	465 90.50.650
.45	515 90.50.700
.50	565 90.50.750
.55	615 90.50.800
.60	665 90.50.850

840

840.13.325.0

B_{Rl} [mm]	Part No. Installation set
.13	165 90.50.350
.15	178 90.50.350
.16	190 90.50.375
.17	203 90.50.375
.18	215 90.50.400
.20	228 90.50.400
.21	240 90.50.425
.22	253 90.50.425
.23	265 90.50.450
.25	278 90.50.450
.26	290 90.50.475
.27	303 90.50.475
.28	315 90.50.500
.30	328 90.50.500
.31	340 90.50.525
.32	353 90.50.525
.33	365 90.50.550
.35	378 90.50.550
.36	390 90.50.575
.37	403 90.50.575
.38	415 90.50.600
.40	428 90.50.600
.41	440 90.50.625
.42	453 90.50.625
.43	465 90.50.650
.45	478 90.50.650
.46	490 90.50.675
.47	503 90.50.675
.48	515 90.50.700
.50	528 90.50.700
.51	540 90.50.725
.52	553 90.50.725
.53	565 90.50.750
.55	578 90.50.750
.60	628 90.50.800



Trough (Part No. 90.30 and 90.31) with reinforced mounting angles for extreme applications

! The inner width of the guide trough and the length of the C-Profile of the assembly kit can differ according to the bracket you choose. Please call us!

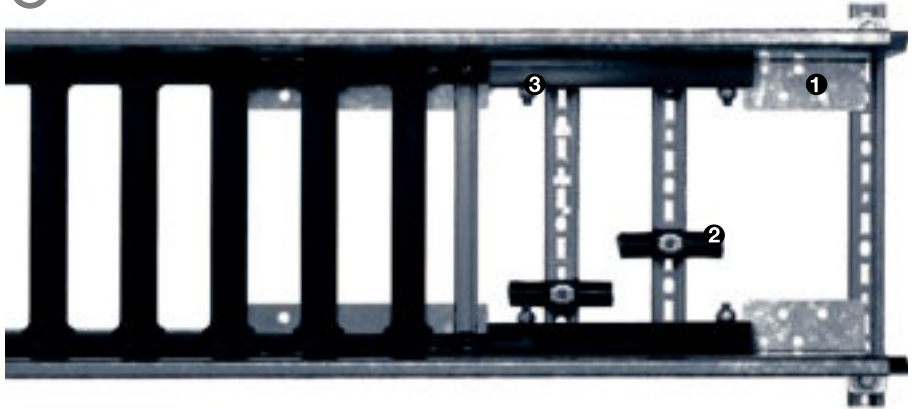

Fixed end module for steel guide troughs

Until now, the steel trough had to be modified on site to fit the mounting brackets at the stationary end of the E-Chain®. That is now history. With its prefabricated boreholes, the 2.000 mm long kit can be used for middle-feed, end-feed and opposed installation.

- ① Fast fixation of mounting brackets thanks to prefabricated boreholes
- ② Fast installation of C-profile for strain relief
- ③ Fast bolting of glide bars
- Available immediately for Part No. 93.80.01, 94.80.01 and 96.80.01

Industries: Power plants, coal conveyors, mining, composting plants, raw material storage, gipsumplants, etc.



Part No.	For Steel guide troughs	For Series
90.80.01	90.30 / 90.31	800, 840
92.80.01*	92.30 / 92.31	2500, 255, E6.29, R6.29
93.80.01	93.30 / 93.31	3500, R68, E4.42/H4.42/R4.42, 380/390/R780, 3838/3938/R7838, E6.52, R6.52
94.80.01	94.30 / 94.31	E4.56/H4.56/R4.56, 400/410/R880, 4040/4140/R8840, 4040HD/R8840HD, 14040/14140/R18840, 14240/14340, E6.62
95.80.01*	95.30 / 95.31	2700
96.80.01	96.30 / 96.31	E4.80/H4.80/R4.80, 5050/5150/R9850, 5050HD/R9850HD, 15050/5150/R19850, E6.80
97.80.01*	97.30 / 97.31	E4.32/H4.32/R4.32, 280/290/R770, 2828/2928/R7728, E6.40, R6.40
98.80.01*	98.30 / 98.31	600/601/R608, 640, 1640/R1608
99.80.01*	99.30 / 99.31	E4.28/R4.28, 220/R760, E6.35

*available upon request - time of delivery 6 weeks after intake of order

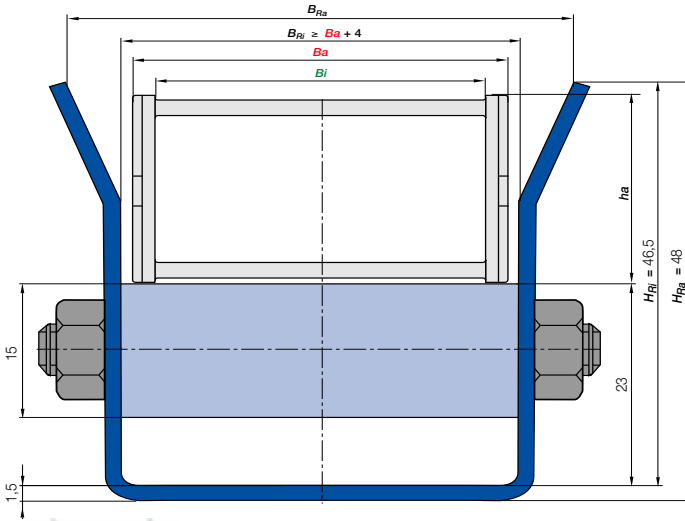

For the following
E-Chains/E-Tubes:

System E2 Series

- 10
- B15

System Zipper Series

- 15/R15



For Series 10, 15 and B15 are steel guide troughs for one side available. They have got a continuous glide bar for the transition from area with the glide bars to the area without glide bars. Available from stock are the guide troughs for the E-Chains® with an outer width up to 60 mm. For the E-Chains® with a width of more than 60 mm special solutions are on short call. For this trough sizes are no installation sets necessary as the guide troughs are made of a single U-profile. The solution for the trough joint is specific for every application.

B_a = Outer E-Chain® width
 B_i = Inner E-Chain® width
 h_a = E-Chain® outer height
 H_{Ri} = Inner trough height
 H_{Ra} = Outer trough height
 B_{Ri} = Inner trough width
 B_{Ra} = Outer trough width

For Series	Part No.	Dim. B_{Ra} [mm]	Dim. B_{Ri} [mm]	Weight
For Series 10.015/15.015/B15.015				
Trough without glide bar, 2-m section	91.10	40,5	30	1,50 kg/m
Trough with glide bar, 2-m section	91.11	40,5	30	2,10 kg/m
For Series 10.025/15.025/B15.025				
Trough without glide bar, 2-m section	91.20	50,5	40	1,65 kg/m
Trough with glide bar, 2-m section	91.21	50,5	40	2,35 kg/m
For Series 10.038/15.038/B15.038				
Trough without glide bar, 2-m section	91.30	62,5	52	1,80 kg/m
Trough with glide bar, 2-m section	91.31	62,5	52	2,70 kg/m
For Series 10.050/15.050/B15.050				
Trough without glide bar, 2-m section	91.40	72,5	62	1,90 kg/m
Trough with glide bar, 2-m section	91.41	72,5	62	3,15 kg/m
For Series 10.5/15.5/B15.5				
Trough without glide bar, 2-m section	91.50	89,5	79	2,15 kg/m
Trough with glide bar, 2-m section	91.51	89,5	79	4,30 kg/m
For Series 10.6/15.6/B15.6				
Trough without glide bar, 2-m section	91.60	106,5	96	≈ 2,40 kg/m
Trough with glide bar, 2-m section	91.61	106,5	96	≈ 4,60 kg/m
For Series 10.7/15.7/B15.7				
Trough without glide bar, 2-m section	91.70	126,5	116	≈ 2,80 kg/m
Trough with glide bar, 2-m section	91.71	126,5	116	≈ 5,20 kg/m

Trough material: St 1203 galvanized



Order example: Length of travel 30 m - Center mounted for Series 10.038.100.0 with B_{Ri} = 52

Guide trough-channel **without** glide bars:

10 m Guide trough = 5 x 2 m sections (without glide bars)

Part No. 91.30

Guide trough-channel **with** glide bars:

10 m Guide trough = 5 x 2 m sections (with glide bars)

Part No. 91.31

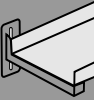



Further troughs

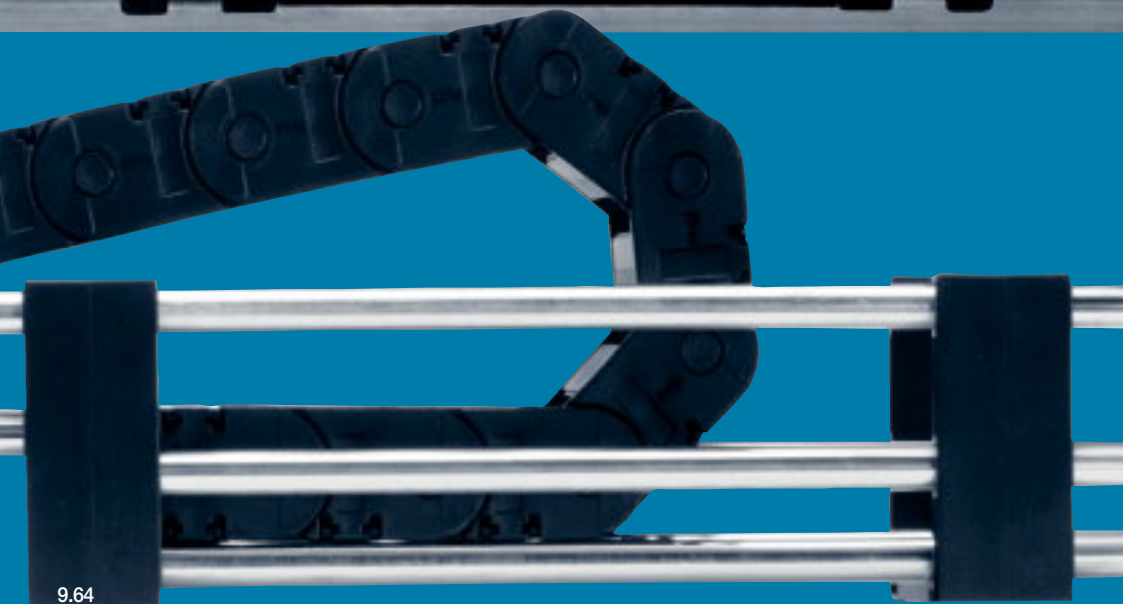

Economically priced and simple guide options

igus® tubular trough and insert trough systems are simple and favorably priced options to safely guide E-Chains®. Recommended for less demanding applications and applications with travel speeds below 2 m/s, as well as travel distances below 50 m. The igus® tubular trough is ideal for applications where quick cleaning and good visibility are required. The crucial advantage of the igus® insert trough is the low price and the very simple and fast installation.



Tubular trough system RS - lets light and dirt through

- Resistant to dirt - wear debris falls through
 - More translucent than sheet metal constructions
 - Easy and fast assembly
 - Low price
 - Easy and space saving delivery
 - iF-Design Award
- from page 9.66

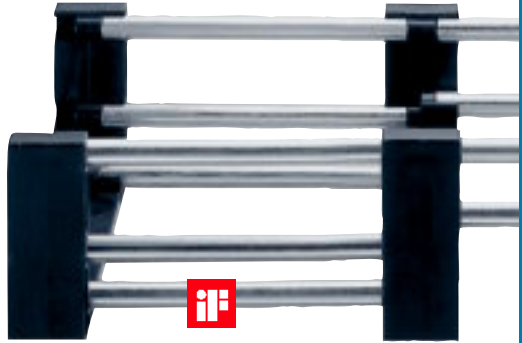

Snap-in trough system SP - simple and cost effective

- Smaller than conventional troughs
 - Easy and fast assembly
 - No sharp metal edges in the internal area because of covered connectors
 - Low price because of easy assembly
- from page 9.68

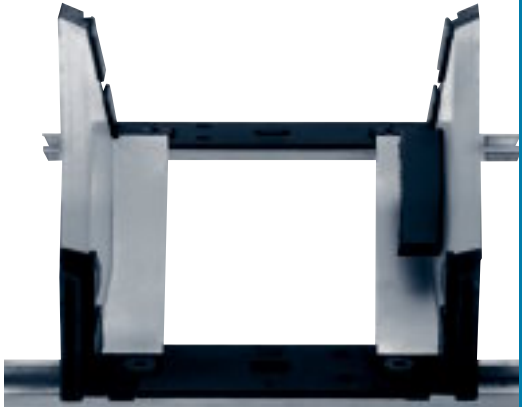

Especially for supporting the lower run - igus® Support tray



For support of the lower run - Support tray tool kit

- Complete system, ready to install
 - No more costly self-made designs
 - Easy installation onto your machine, on profiles or wall-mount brackets
- from page 9.70





The adjacent picture shows the transition from area without glide bar to area with glide bar in detail

Tubular trough system RS - low priced guide trough solution

The Tubular Trough System RS enables the setting up of a guide trough through simply connecting the polymer tubes and installation elements. This system is used practically everywhere in mechanical engineering where elegant design is important and where no great mechanical loads are present. The System RS is a good choice particularly where dirt, chips occur, because the waste products simply fall through the spaces and are hence not relevant as possible disturbance factors. The tubes are available in galvanized steel or polymer.

The assembly of the guide trough is very simple, because the individual elements are not screwed together but, instead, only pushed together and

clipped in. The difficult setting of the correct width is no longer necessary, since fitting spacers are delivered with the complete order. ● **The junction installation set** is required for junction of area without glide bar to area with glide bar ● **The fastening set (Part. No. 92.70 and Part. No. 92.71)** is used for fastening the fixed point of the above-mentioned E-Chain® in the trough. It consists of 2 clamping parts which connect the end element set (Material igumid G) **without** glide bar ❶ Installation set (Material igumid G) **with** glide bar ❷ Installation set of junction of area ❸ Tubular steel $\varnothing 12 \times 1$, (galvanized)

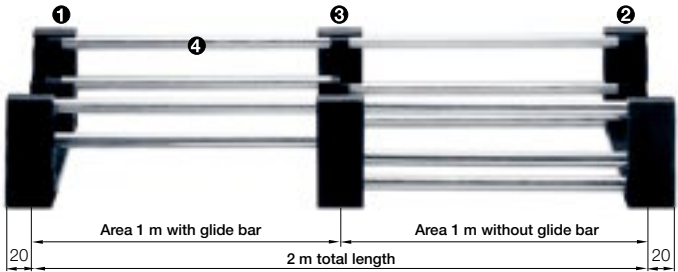

For the following E-Chains®/E-Tubes:

System E2 Series

- 2500
- 255
- 250 classic

System E6 Series

- E6.29/R6.29*

XX	Bi	Ba	B _{Ra}	B _{Ri}
02*	25	41	81	45
03	38	54	94	58
05	57	73	113	77
07	77	93	133	97
09	89	105	145	109
10	103	119	159	123
12	125	141	181	145

XX = E-Chain® width

* without spacer plate

Part No. 92.70 and Part No. 92.71

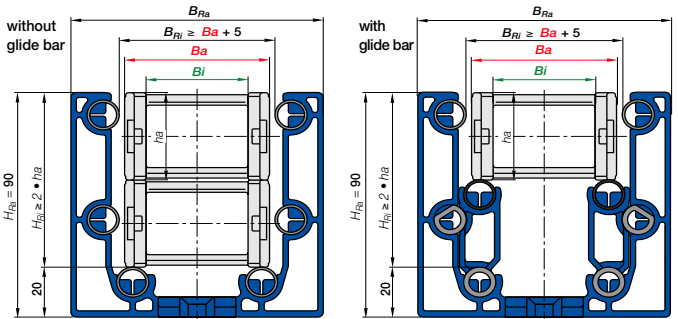

Tubular Trough Components	Part No.	Weight [kg]
Installation set without glide bars	92.70. XX	≈ 0,15
Installation set with glide bars	92.71. XX	≈ 0,12
Installation set junction	92.74. XX	
Fastening set	92.77.2	
Tubular steel, diameter 12 x 1 galvanized; (L = 985) for clearance Installation set 1 m	92.80	≈ 0,28

Supplement Part No. with the required width in the table. Example: 92.71. 10

Order Example: Inner width 57 mm. For 8 m trough the following parts are required:

Area with glide bar:	4 x Installation set Part No. 92.71.05 + tube: 4 x 4 piece Part No. 92.80
Area without glide bar:	4 x Installation set Part No. 92.70.05 + tube: 4 x 6 piece Part No. 92.80
	1 x junction Part No. 92.74.05

Part No. 93.70 and Part No. 93.71

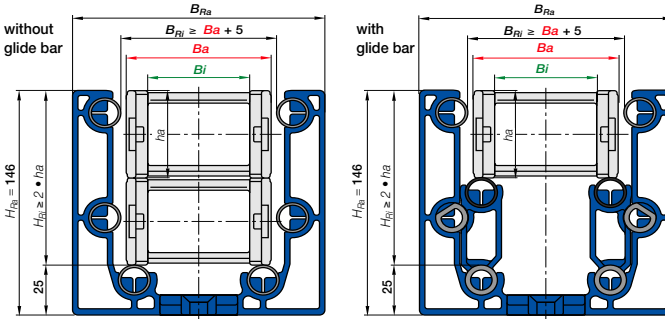

Tubular Trough Components	Part No.	Weight [kg]
Installation set without glide bars	93.70. <u>XX</u>	≈ 0,25
Installation set with glide bars	93.71. <u>XX</u>	≈ 0,20
Installation set junction	93.74. <u>XX</u>	
Tubular steel, diameter 12 x 1 galvanized; (L = 985) for clearance Installation set 1 m	93.80	≈ 0,50

Supplement Part No. with the required width in the table. Example: 93.71. 050

Order Example: Inner width 50 mm. For 8 m trough the following parts are required:
 Area **with** glide bar: 4 x Installation set **Part No. 93.71.050** + tube: 4 x 4 piece **Part No. 93.80**
 Area **without** glide bar: 4 x Installation set **Part No. 93.70.050** + tube: 4 x 6 piece **Part No. 93.80**
 1 x junction **Part No. 93.74.050**

For the following E-Chains/E-Tubes:

- System E2 Series**
- 3500
 - 350 classic
- System E6 Series**
- E6.52* ● R6.52*

<u>XX</u>	Bi	Ba	B _{Ra}	B _{Ri}
050	50	70	130	75
075	75	95	155	100
100	100	120	180	125
115	115	135	195	140
125	125	145	205	150
150	150	170	230	175
175	175	195	255	200
200	200	220	280	225
225	225	245	305	250
250	250	270	330	275

XX = E-Chain* width
* without spacer plate

For 1 m trough **without** glide bars
6 tubes 1 meter long are required.
For 1 m trough **with** glide bars 4 tubes 1 meter long are required.

Part No. 95.70 and Part No. 95.71

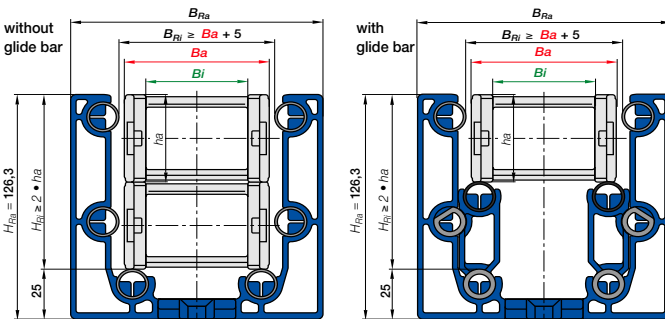

Tubular Trough Components	Part No.	Weight [kg]
Installation set without glide bars	95.70. <u>XX</u>	≈ 0,15
Installation set with glide bars	95.71. <u>XX</u>	≈ 0,12
Installation set junction	95.74. <u>XX</u>	
Fastening set	93.80	≈ 0,50

Tubular steel, diameter 12 x 1 galvanized; (L = 985) for clearance Installation set 1 m
 Supplement Part No. with the required width in the table. Example: 95.71. 10

Order Example: Inner width 50 mm. For 8 m trough the following parts are required:
 Area **with** glide bar: 4 x Installation set **Part No. 95.71.05** + tube: 4 x 4 piece **Part No. 93.80**
 Area **without** glide bar: 4 x Installation set **Part No. 95.70.05** + tube: 4 x 6 piece **Part No. 93.80**
 1 x junction **Part No. 95.74.05**

For the following E-Chains/E-Tubes:

- System E2 Series**
- 2700
 - 27 classic

<u>XX</u>	Bi	Ba	B _{Ra}	B _{Ri}
05	50	66	124	71
06*	65	81	139	86
07	75	91	149	96
09*	90	106	164	111
10	100	116	174	121
12	125	141	199	146
15	150	166	224	171
17	175	194	252	199
20	200	219	277	224

XX = E-Chain* width
*upon request

For 1 m trough **without** glide bars
6 tubes 1 meter long are required.
For 1 m trough **with** glide bars 4 tubes 1 meter long are required.





The spacer plate makes the trough installation easier because it is no longer necessary to set the trough width

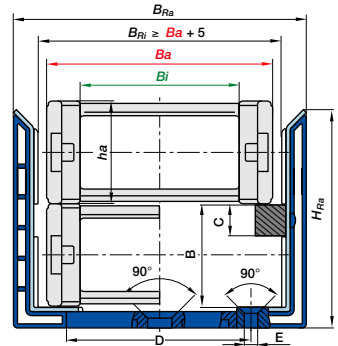

For the following
E-Chains®/E-Tubes:

System E2 Series

- 10
- B15/B15i

Zipper Series

- 15

Part No. 91.930

Snap-In Trough Components

Trough set without glide bars, 2 glide strips of 1 m	91.930	≈ 1,50
Trough set with glide bars, 2 glide strips of 1 m	91.931	≈ 1,90
Glide bar set, 2 glide bars, 1 m section	91.920	
Screw set	91.921	
Installation set with spacer plate	91.950. [XX]	≈ 0,05
Installation set without spacer plate	91.950	≈ 0,03

Part No. Weight
Trough [kg/m]

Supplement Part No. with the required width in the table. Example: **91.950. [05]**

[XX]	H _{Ra}	B	C	B _{Ri}	D	ø E	B _{Ra}
015	55,5	23	12	29,6	21	4,2	46
025	55,5	23	12	39,6	31	4,2	56
038	55,5	23	12	51,6	43	4,2	68
050	55,5	23	12	63,6	55	4,2	80
05	55,5	23	12	79,6	71	4,2	96
06	55,5	23	12	96,6	88	4,2	113
07	55,5	23	12	116,6	108	4,2	133



For the following
E-Chains®/E-Tubes:

System E2 Series

- 2500
- 250 classic

System E6 Series

- E6.29 ● R6.29

(without spacer plate)

Part No. 92.930

Snap-In Trough Components

Trough set without glide bars, 2 glide strips of 2 m	92.930	≈ 5,50
Trough set with glide bars, 2 glide strips of 2 m	92.931	≈ 6,50
Glide bar set, 2 glide bars, 2 m section	92.920	
Screw set	92.921	
Installation set with spacer plate	92.950. [XX]	≈ 0,10
Installation set without spacer plate	92.950	≈ 0,08

Part No. Weight
Trough [kg/m]

Supplement Part No. with the required width in the table. Example: **92.950. [05]**

[XX]	H _{Ra}	B	C	B _{Ri}	D	ø E	B _{Ra}
02*	76,6	35	15	43	14	6,6	67
03	76,6	35	15	56	27	6,6	80
05	76,6	35	15	75	46	6,6	99
07	76,6	35	15	95	66	6,6	119
09	76,6	35	15	107	78	6,6	131
10	76,6	35	15	121	92	6,6	145
12	76,6	35	15	143	114	6,6	167

[XX] = E-Chain® width

* without spacer plate



Order Example - for 20 m trough Part. No. 93.930
the following parts are required:

10 m Part No. 93.930, Trough set without glide bars (5 x 2 m)

10 m Part No. 93.931, Trough set with glide bars (5 x 2 m)

Part No. 93.950. 050, Installation set

B_a = Outer E-Chain* width
 B_i = Inner E-Chain* width
 h_a = E-Chain* outer height
 H_{Ri} = Inner trough height
 H_{Ra} = Outer trough height
 B_{Ri} = Inner trough width ►
 depends on dim. B_a
 B_{Ra} = Outer trough width

Part No. 93.930

Snap-In Trough Components

	Part No. Trough	Weight [kg/m]
Trough set without glide bars, 2 glide strips of 2 m	93.930	≈ 9,00
Trough set with glide bars, 2 glide strips of 2 m	93.931	≈ 10,00
Glide bar set, 2 glide bars, 2 m section	93.920	
Screw set	93.921	
Installation set with spacer plate	93.950. XX	≈ 0,20
Installation set without spacer plate	93.950	≈ 0,16

Supplement Part No. with the required width in the table. Example: 93.950. 050

XX	H_{Ra}	B	C	B_{Ri}	D	ø E	B_{Ra}
050	138,6	64	15	74	40	6,6	102
075	138,6	64	15	99	65	6,6	127
100	138,6	64	15	124	90	6,6	152
115	138,6	64	15	139	105	6,6	167
125	138,6	64	15	149	115	6,6	177
150	138,6	64	15	174	140	6,6	202
175	138,6	64	15	199	165	6,6	227
200	138,6	64	15	224	190	6,6	252
225	138,6	64	15	249	215	6,6	277
250	138,6	64	15	274	240	6,6	302

Art. Nr. 95.930

Snap-In Trough Components

	Part No. Trough	Weight [kg/m]
Trough set without glide bars, 2 glide strips of 2 m	95.930	≈ 7,10
Trough set with glide bars, 2 glide strips of 2 m	95.931	≈ 8,10
Glide bar set, 2 glide bars, 2 m section	95.920	
Screw set	95.921	
Installation set with spacer plate	95.950. XX	≈ 0,11
Installation set without spacer plate	95.950	≈ 0,13

Supplement Part No. with the required width in the table. Example: 95.950. 05

XX	H_{Ra}	B	C	B_{Ri}	D	ø E	B_{Ra}
05	106,6	50	15	70	40	6,6	94
06*	106,6	50	15	85	55	6,6	109
07	106,6	50	15	95	65	6,6	119
09*	106,6	50	15	110	80	6,6	134
10	106,6	50	15	120	90	6,6	144
12	106,6	50	15	145	115	6,6	169
15	106,6	50	15	170	140	6,6	194
17	106,6	50	15	198	168	6,6	222
20	106,6	50	15	223	193	6,6	247



For the following
E-Chains*/E-Tubes:

System E2 Series

● 3500

● 350 classic

System E6 Series

● E6.52 ● R6.52

(without spacer plate)

XX = E-Chain* width



For the following
E-Chains*/E-Tubes:

System E2 Series

● 2700

● 27 classic

XX = E-Chain* width

* without spacer plate





Support Tray

Support tray | For support of the lower run

igus®

For support of the lower run - Support tray tool kit

Simple one-piece support trays for the lower E-Chain® run, according with your requirements and specification. Your width, height and color - we supply the fitting E-Chain®, together with the support tray system. Ready to install onto your machine or application. Save on procurement and design time.

- Complete system, ready to install
- No more costly self-made designs
- Easy installation onto your machine, on profiles or wall-mount brackets

igus® support tray - in 2 types
and 4 options available

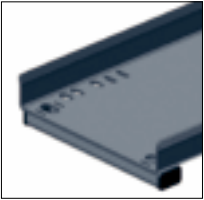

Option 01 -
with connection-rail

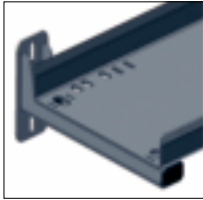

Option 02 -
with bracket

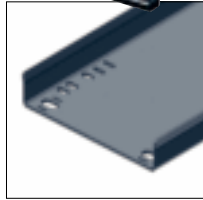

Option 03 -
without rail

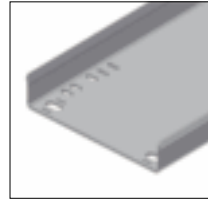

Option 04 -
customized

For many widths available from stock,
with many mounting possibilities



Delivery time: 3-10 days





For the following
E-Chains /E-Tubes:

- E2/000**
 - 2400/2450/2480/2500
 - 2600/2650/2680/2700
- E4.1**
 - E4.21 (210)
 - E4.28/R4.28
 - E4.32/H4.32/R4.32
- E4/00**
 - 220/R760
 - 280/290/R770
- E4/4**
 - 2828/2928/R7728
- E6**
 - E6.29/R6.29
 - E6.35
 - E6.40/R6.40

- ① Support tray type 01 - Standard-length from stock 1 m and 2 m
- ② All connection rails 975 mm
- ③ Bracket for easy mounting on your application

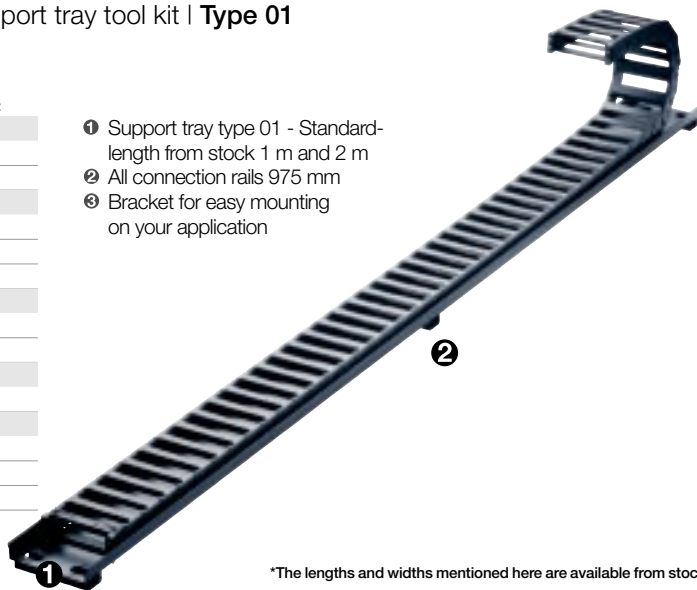

*The lengths and widths mentioned here are available from stock in the standard black color. For other lengths, widths and colors, please contact us.

Product Range*

System	Suitable for the following series ▼	Widths-index	B_{Ra} [mm]	B_{Ri} [mm]	Part No. Support-tray, single	Part No. Support-tray with bracket	Part No. single bracket
E2/000	2400/2450/2480/2500	.05	89	80	S9.010.05.XXXX,0	S9.011.05.XXXX,0	907.724.05
		.07	114	105	S9.010.07.XXXX,0	S9.011.07.XXXX,0	907.724.07
		.10	139	130	S9.010.10.XXXX,0	S9.011.10.XXXX,0	907.724.10
E2/000	2600/2650/2680/2700	.05	89	80	S9.010.05.XXXX,0	S9.011.05.XXXX,0	907.724.05
E4.1	E4.32/H4.32/R4.32	.07	114	105	S9.010.07.XXXX,0	S9.011.07.XXXX,0	907.724.07
E4/4	2828/2928/R7728	.10	139	130	S9.010.10.XXXX,0	S9.011.10.XXXX,0	907.724.10
E4/00	280/290/R770	.15	185	175	S9.010.15.XXXX,0	S9.011.15.XXXX,0	907.724.15
E4.1	E4.21	.050	89	80	S9.010.05.XXXX,0	S9.011.05.XXXX,0	907.724.05
E6	E6.29/R6.29	.070	114	105	S9.010.07.XXXX,0	S9.011.07.XXXX,0	907.724.07
E6	E6.35	.100	139	130	S9.010.10.XXXX,0	S9.011.10.XXXX,0	907.724.10
E4.1	E4.28/R4.28	.050	89	80	S9.010.05.XXXX,0	S9.011.05.XXXX,0	907.724.05
E4/00	220/R760	.070	114	105	S9.010.07.XXXX,0	S9.011.07.XXXX,0	907.724.07
E6	E6.40/R6.40	.100	139	130	S9.010.10.XXXX,0	S9.011.10.XXXX,0	907.724.10
		.150	185	175	S9.010.15.XXXX,0	S9.011.15.XXXX,0	907.724.15

Please replace XXXX by the standard lengths 1000 or 2000 mm available from stock!

Accessories - optional bracket

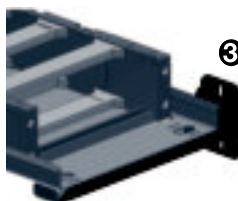

Bracket for easy mounting on your application (see table above for Part No.)

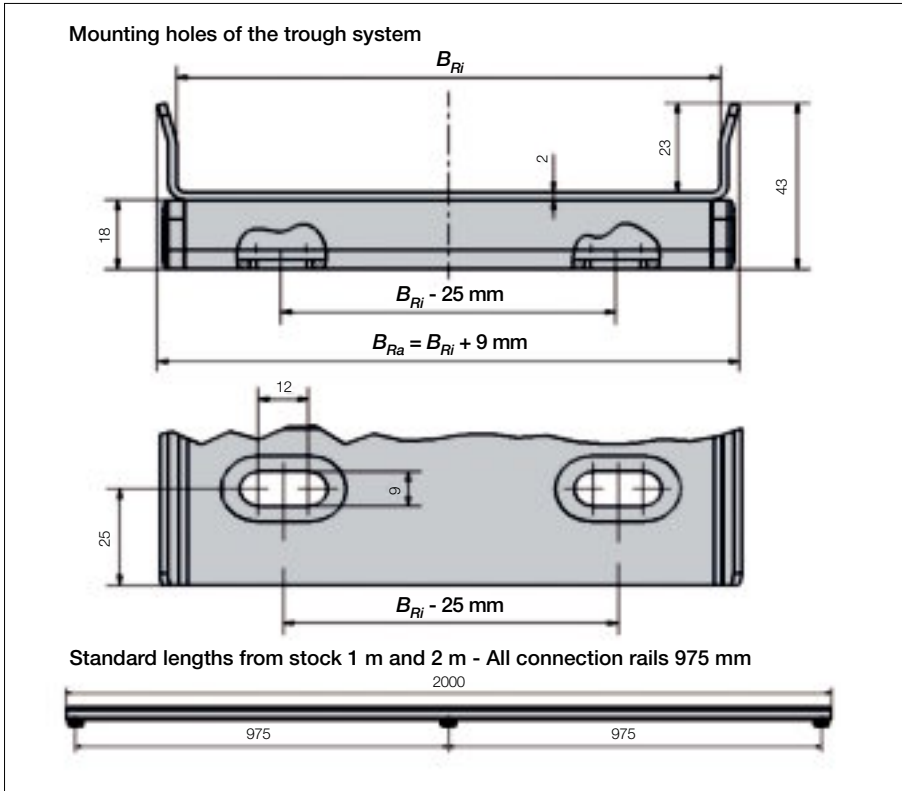

S9. 010. 07. 1000. 0



Part No. structure
1000 mm

Color, powdered black
Length 1000 mm
E-Chain®- width
without bracket
Support tray

S9. 011. 15. 2000. 0



Part No. structure
2000 mm

Color, powdered black
Length 2000 mm
E-Chain®- width
with bracket
Support tray

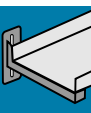
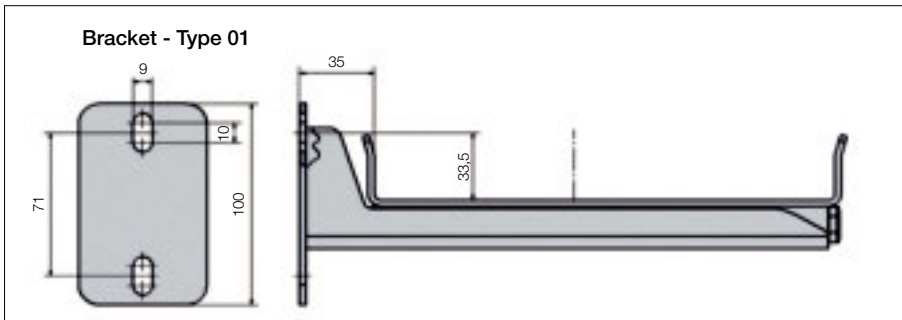



For the following
E-Chains /E-Tubes:

- E2/000
 - 3400/3450/3480/3500
- E4.1
 - E4.42/H4.42/R4.42
 - E4.56/H4.56/R4.56
 - E4.80/H4.80/R4.80
- E4/00
 - 380/390/R780
 - 400/410/R880
- E4/4
 - 3838/3938/R7838
 - 4040/4140/R8840
 - 5050/5150/R9850
- E4/light
 - 14040/14140/R18840
 - 14240/14340
 - 15050/15150/R19850
- E4/00
 - E6.52/R6.52
 - E6.62
 - E6.80

- ① Support tray type 02 - Standard-length from stock 1 m and 2 m
- ② All connection rails 975 mm
- ③ Bracket for easy mounting on your application

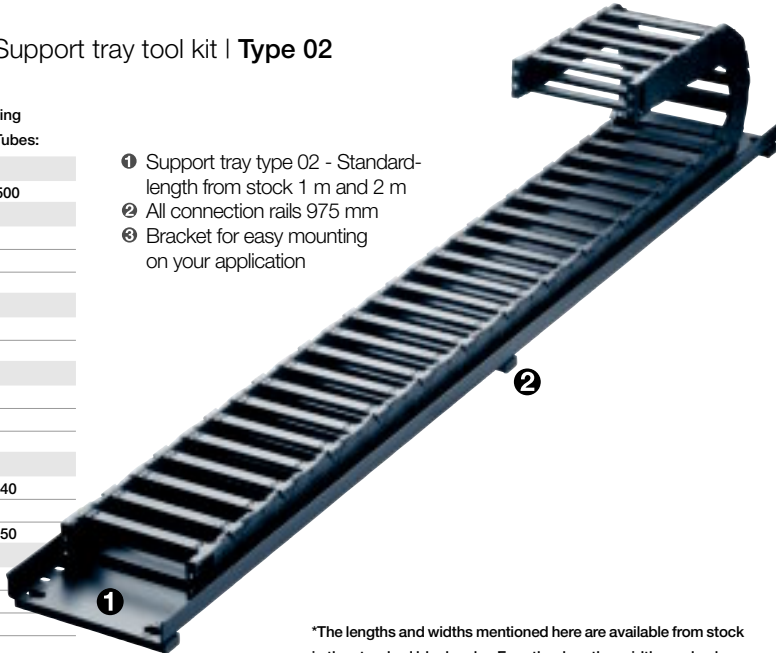

*The lengths and widths mentioned here are available from stock in the standard black color. For other lengths, widths and colors, please contact us.

Product Range*

System	Suitable for the following series ▼	Widths-index	B_{Ra} [mm]	B_{Ri} [mm]	Part No. Support-tray, single	Part No. Support-tray with bracket	Part No. single bracket
E4.1	E4.42/H4.42/R4.42	.10	167	156	S9.020.10. XXXX ,0	S9.021.10. XXXX ,0	907.724.10
E4.1	E4.56/H4.56/R4.56	.15	217	206	S9.020.15. XXXX ,0	S9.021.15. XXXX ,0	907.724.15
E4.1	E4.80/H4.80/R4.80	.20	267	256	S9.020.20. XXXX ,0	S9.021.20. XXXX ,0	907.724.20
E4/00	380/390/R780	.25	317	306	S9.020.25. XXXX ,0	S9.021.25. XXXX ,0	907.724.25
E4/00	400/410/R880						
E4/4	3838/3938/R7838						
E4/4	4040/4140/R8840						
E4/4	5050/5150/R9850						
E4/light	14040/14140/R18840						
E4/light	14240/14340						
E4/light	15050/15150/R19850						
E6	E6.62						
E6	E6.80						
E4/00	3400/3450/3480/3500	.100	167	156	S9.020.10. XXXX ,0	S9.021.10. XXXX ,0	907.724.10
E6	E6.52/R6.52	.150	217	206	S9.020.15. XXXX ,0	S9.021.15. XXXX ,0	907.724.15
		.200	267	256	S9.020.20. XXXX ,0	S9.021.20. XXXX ,0	907.724.20
		.250	317	306	S9.020.25. XXXX ,0	S9.021.25. XXXX ,0	907.724.25

Please replace XXXX by the standard lengths 1000 or 2000 mm available from stock!

Accessories - optional bracket

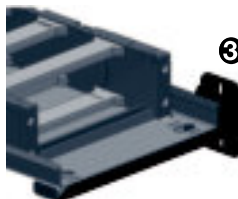

Bracket for easy mounting on your application (see table above for Part No.)

Mounting holes of the trough system

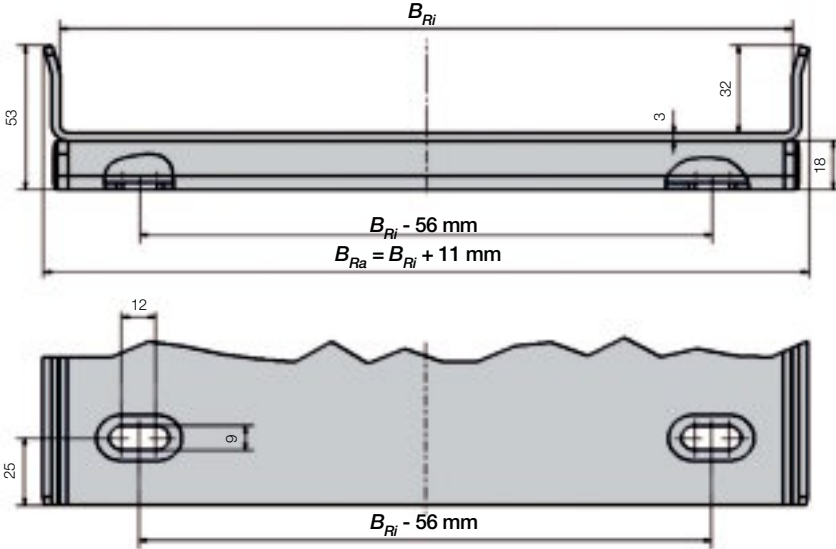

Standard lengths from stock 1 m and 2 m - All connection rails 975 mm

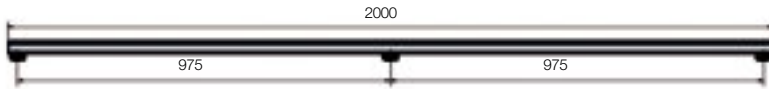

S9.	020.	20.	1000.	0
-----	------	-----	-------	---



Part No. structure
1000 mm



Color, powdered black
Length 1000 mm
E-Chain®- width
without bracket
Support tray

S9.	021.	20.	2000.	0
-----	------	-----	-------	---



Part No. structure
2000 mm



Color, powdered black
Length 2000 mm
E-Chain®- width
with bracket
Support tray

Bracket - Type 02

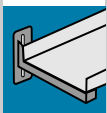
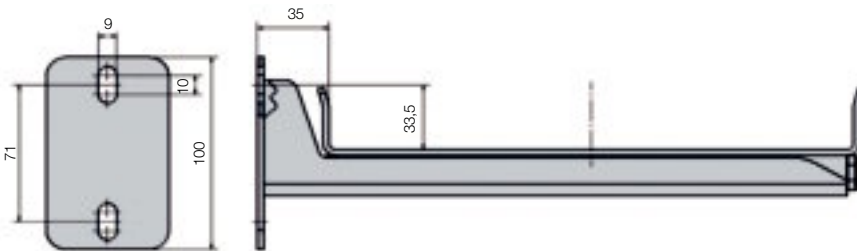

Special Solutions for Long Travels



System P4 | Rol E-Chain® | Very long travels, high speeds, quiet



Product	Page
System P4	
System P4 - Safe, maintenance-free energy supply system on long travels up to 800 m and more for outdoor cranes or conveyor systems. Low-noise operation, high service life	9.78

Rol E-Chain® | Rolling instead of gliding



Product	Page
Rol E-Chain®	
Major reduction in drive power to less than 25 % for moving the E-Chain®	
Travels up to 800 m, speeds up to 6 m/s	9.86

System AUTO-GLIDE | Long travels without guide troughs



Product	Page
AUTO-GLIDE	
Self-guiding E-ChainSystems® - No Guide Troughs required!	
Travels up to 50 m, speeds up to 1,5 m/s	9.90

Guidelok horizontal | Upper run guide for long travels



Product	Page
Guidelok horizontal	
Chips cannot get stuck between upper and lower run -	
Enormous increase of „self supporting“ length of E-Chains®	9.96

Guidelok vertical | For safe vertical guidance



Product	Page
Guidelok vertical	
Keeps hanging E-Chains® in line - no swinging sideways -	
No bouncing of E-Chains® in vertical applications with horizontal dynamics	9.98

LBT Flizz® | Enclosed plastic trough



Product	Page
LBT Flizz®	
Modular guide trough construction kit	
Travels up to 200 m, speeds up to 8 m/s	9.100

Micro Flizz® | Small E-Chains® in aluminum profile



Product	Page
Micro Flizz®	
ONE compact system for a secure guidance of power, data and air	
Maintenance-free alternative for busbar	9.104

LeviChain | Magnetic E-ChainSystem® - it "floats"



Product	Page
LeviChain	
Long travel possible without laying the E-Chain® systems on top of each other. Almost no abrasion and very low wear due to low-abrasion E-Chain® links as well as almost contactless movement of the E-Chain®	9.112



System P4

A detailed close-up photograph of a mechanical assembly, likely a camera or sensor system. The central focus is a white vertical component, possibly a lens or sensor housing, surrounded by various black plastic and metal parts. There are several circular openings with four small white dots inside, which could be sensors or indicators. The background is a solid blue color.

System P4 | Rol E-Chain® | For very long travels, speed (up to 10 m/s)



Standard Rol E-Chain® has been used in over 1000 installations worldwide. Some industries - cranes, for example - have ever-increasing demands for length of travel, fill weight and speed. **Systems of this type should be designed by our system design engineers. We will be more than willing to submit an offer to you. Please contact us about this.**

- Identical pitch of the chain link with or without roller
- Smooth, low noise operation through identical pitch length for links with and without rollers
- Integrated "captive" roller in the side part
- Long travels (up to 800 m), high additional loads (up to 30 kg/m)
- For very long travels and high speeds >10 m/s travel speed
- AUTO-GLIDE crossbars provide for a safe guiding in very long travels
- 4 different inner heights: (32, 42, 56, 80 mm) available
- Large modular tool box system with interior separations of the System E4

Typical industries and applications

- Cranes
- Warehousing
- Equipment manufacturing
- Gantry robots
- Material handling



Find a video online ► www.igus.de/P4_Film

Application video ► www.igus.de/P4cranes



Offset operation of upper and lower run, resulting in continuous roll-through surface

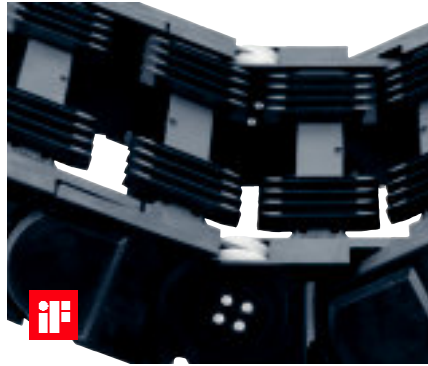

System P4 - Very quiet operation through identical pitch of all chain links. AUTO-GLIDE crossbars offer a safe guidance in very long travels

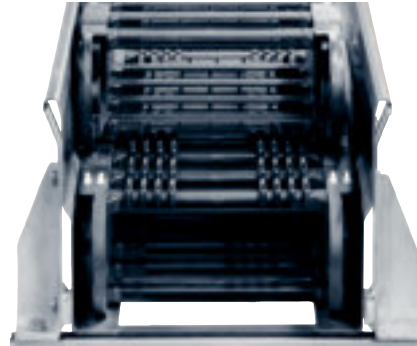

Guide trough system linked with the AUTO-GLIDE crossbars ensures the offset operation of the upper and lower run - safe at high speeds

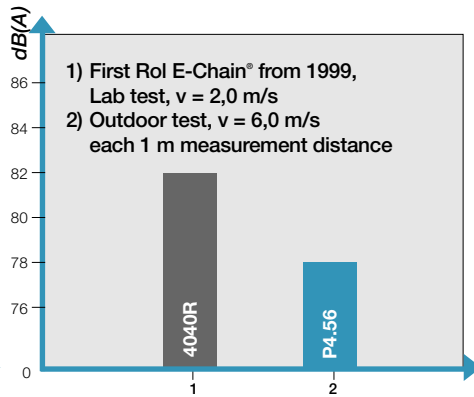
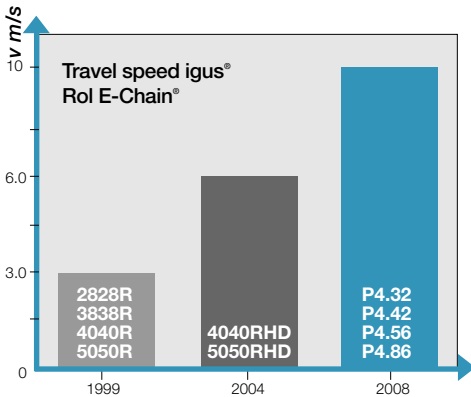

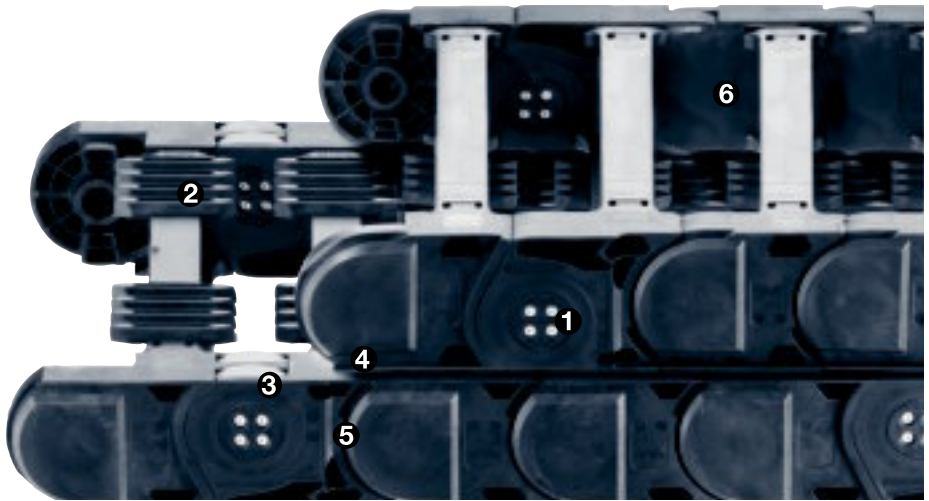

Safe, low-noise, abrasion-resistant energy supply system on long travels - igus® system P4

With the low-maintenance igus® System P4, a secure energy supply system can be implemented on long travels up to 800 m for cranes or conveyor systems. The upper run and lower run roll staggered on each other. Thus the tribo-optimized plastic rollers don't overrun, but roll on a continuous, wide roll-through surface. The P4 E-Chain® is safely guided by the comb-shaped AUTO-GLIDE crossbars and the special trough system. **Ideal for applications with high travel speeds (up to 10 m/s) and large fill weights (up to 30 kg/m)**

- ① Low maintenance Rol E-ChainSystem® from tribooptimized plastic rollers
- ② Combshaped AUTO-GLIDE cross bars
- ③ Exceptionally quiet through special roller and link design
- ④ Offset motion of upper and lower run
- ⑤ Same pitch for roller- / chain links
- ⑥ 4 different inner heights: 32, mm, 56 and 80 mm available
- ⑦ Extension link solution for still higher fill weights with 56 and 80 mm inner height available
- ⑧ Robust steel mounting brackets available
- ⑨ Special P4 guide trough system available

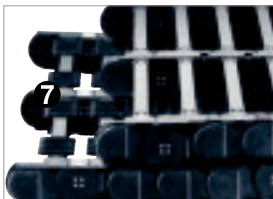

- Extension link for heavy fill weights
- 2 inner heights available (56, 80 mm)
- 50% higher fill weight possible
- Maximum rigidity
- Divides cross section into reasonable compartments (electric/hydraulic)



- New tribo-optimized plastic rollers for all P4 systems
- Wear optimized
- Long cycle life
- Improved rolling
- Lower noise and vibration
- Same pitch for roller links / chain links

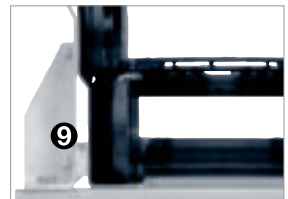

- New guide trough system
- Special geometry in combination with AUTO-GLIDE cross bars allows for offset upper and lower run
- Strong installation kits for long cycle life
- Stainless trough segments resist corrosion and sea water

Energy efficient polymer E-Chains® and cables reduce consumption by up to 57%

With the right materials and clever design, the energy consumption can be drastically reduced, as now proven by current tests and sample calculations in the E-Chain® and cable laboratory at igus®. igus® E-Chains® and Chainflex® cables reduce the required drive power and extend the application's service life.

Gliding application	Standard 100%
Optimized cables	Chainflex® -17%
Stronger E-Chains®	System E4.1 -17%
Rolling instead of gliding	Rol E-Chain® -37%
Better cables, stronger and rolling E-Chains®	System P4 -57%

System P4



+

Chainflex®



= 57%

Saving

Sample calculations online ► www.igus.eu/energyefficiency



Successful application with P4.56 on a new RMG crane. 130 m travel length at 150 m/min speed. Harnessed with igus® Chainflex® motor-, control- and fiber optic cables

3D-CAD files, pdf-downloads and many online features ► www.igus.de/en/p4

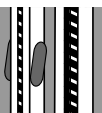
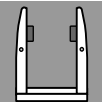
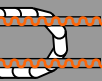
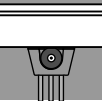
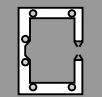
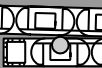
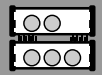

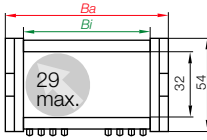
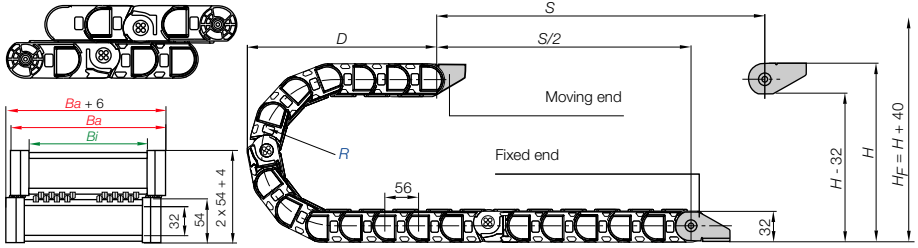

Part No. structure

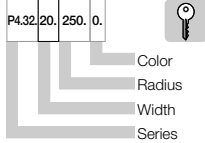

Series P4.32 - Rol E-Chain® with combstile AUTO-GLIDE cross bars

Part No.	Bi	Ba	R	Bending Radii							Weight [kg/m]
P4.32.10.	.0	100	132	075	100	125	150	200	250	300	≈ 3,27
P4.32.15.	.0	150	182	075	100	125	150	200	250	300	≈ 3,83
P4.32.20.	.0	200	232	075	100	125	150	200	250	300	≈ 4,50
P4.32.25.	.0	250	282	075	100	125	150	200	250	300	≈ 5,09

The P4.32 series is available on request from autumn 2009.

Supplement Part No. with required radius. Example: P4.32.15. 100.0

0 = standard color, other colors ▶ page 1.39

Pitch = 56 mm/link Links/mm = 18 (1008 mm) Chain length = $S/2 + K$

- S = Length of travel
 - R = Bending radius
 - H = Nominal clearance height
 - H_F = Required clearance height
 - H_{Ri} = Trough inner height
 - D = Overlength E-Chain® radius in final position
 - K = $\pi \cdot R + \text{"safety"}$
 - D₂ = Overlength - long travels, gliding
 - K₂ = "Further add-on"
 - H₂ = "Mounting height"
- *if the mounting bracket location is set lower

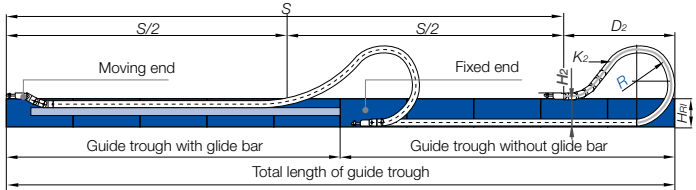

	R	075	100	125	150	200	250	300
H	209	259	309	359	459	559	659	
D	160	185	210	235	285	335	385	
K	350	430	505	585	745	900	1055	
H ₂	*	*	125	125	125	125	125	
D ₂	*	*	*	*	*	*	*	
K ₂	*	*	*	*	*	*	*	

*upon request

Technical Data



Details of material properties

▶ page 1.38

Long travels	from 10 m up to max. 600 m
Speed max. rolling / acceleration max. rolling	max. 10 [m/s] / max. 50 [m/s ²]
Fill weight	max. 7,0 [kg/m]
Material - permitted temperature °C	igumid G / -40° up to +120° C
Flammability class, igumid G	VDE 0304 IIC UL94 HB

Additional Features



Interior separation available - Series E4.32

▶ from page 7.40



Robust steel mounting brackets available



Special P4 guide trough system available

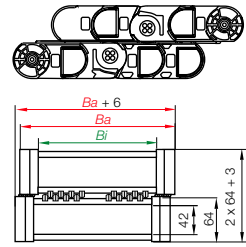
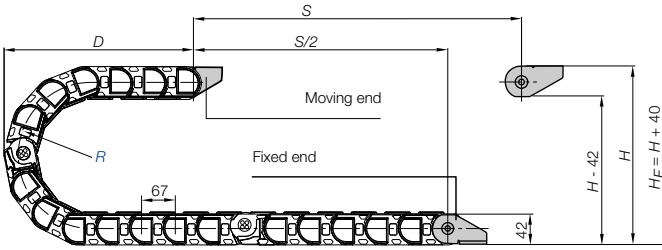

Series P4.42 - Rol E-Chain® with combstipe AUTO-GLIDE cross bars

Part No.	Bi	Ba	R	Bending Radii	Weight [kg/m]
P4.42.10, .0	100	154	100	125 150 200 250 300 350	≈ 4,49
P4.42.15, .0	150	204	100	125 150 200 250 300 350	≈ 4,99
P4.42.20, .0	200	254	100	125 150 200 250 300 350	≈ 5,55
P4.42.25, .0	250	304	100	125 150 200 250 300 350	≈ 6,05

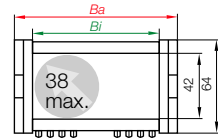

Supplement Part No. with required radius. Example: P4.42.15, 100,0

0 = standard color, other colors ▶ page 1.39

Pitch = 67 mm/link Links/m = 15 (1005 mm) Chain length = $\frac{S}{2} + K$

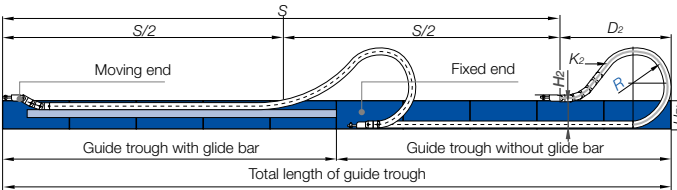

R	100	125	150	200	250	300	350
H	268	318	368	468	568	668	768
D	201	226	251	301	351	401	451
K	450	530	610	765	920	1080	1235
H ₂	140	140	140	140	140	140	140
D ₂	*	*	*	*	*	*	*
K ₂	*	*	*	*	*	*	*

*upon request

Part No. structure

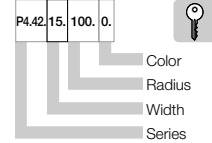

- S = Length of travel
- R = Bending radius
- H = Nominal clearance height
- H_F = Required clearance height
- H_m = Trough inner height
- D = Overlength E-Chain® radius in final position
- K = $\pi \cdot R +$ "safety"
- D₂ = Overlength - long travels, gliding
- K₂ = "Further add-on"
- H₂ = "Mounting height"

*if the mounting bracket location is set lower

Long travels	from 10 m up to max. 800 m
Speed max. rolling / acceleration max. rolling	max. 10 [m/s] / max. 50 [m/s]
Fill weight	max. 15,0 [kg/m]
Material - permitted temperature °C	igumid G / -40° up to +120° C
Flammability class, igumid G	VDE 0304 IIC UL94 HB

Technical Data



Details of material properties

▶ page 1.38



Interior separation available - Series E4.42

▶ from page 7.54



Robust steel mounting brackets available



Special P4 guide trough system available

Additional Features

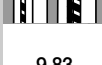
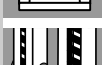
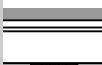
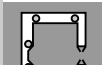
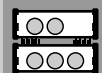

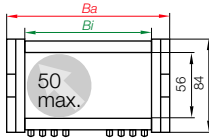
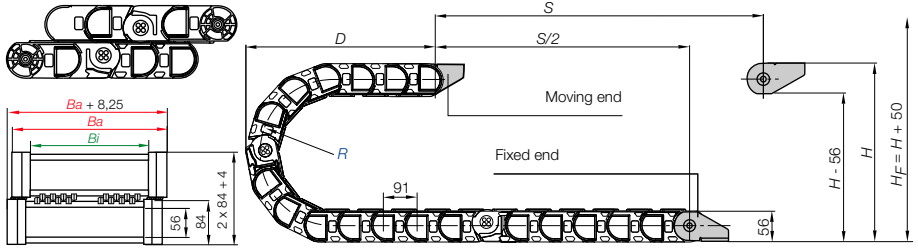

Part No. structure

P4.56.20, 250, 0.



Series P4.56 - Rol E-Chain® with combstipe AUTO-GLIDE cross bars

Part No.	B _i	B _a	R	Bending Radii								Weight [kg/m]
P4.56.20, .0	200	270	150	200	250	300	350	400	450	500	≈ 6,89	
P4.56.25, .0	250	320	150	200	250	300	350	400	450	500	≈ 7,25	
P4.56.30, .0	300	370	150	200	250	300	350	400	450	500	≈ 7,65	
P4.56.35, .0	350	420	150	200	250	300	350	400	450	500	≈ 8,11	
P4.56.40, .0	400	470	150	200	250	300	350	400	450	500	≈ 8,50	

The bending radii 150 | 200 | 400 | 450 | 500 are available upon request.

Delivery time: approx. 6-8 weeks after receipt of order!

Supplement Part No. with required radius. Example: P4.56.20, 250 | 0

0 = standard color, other colors ▶ page 1.39

Pitch = 91 mm/link Links/m = 11 (1001 mm) Chain length = $S/2 + K$

- S = Length of travel
- R = Bending radius
- H = Nominal clearance height
- H_F = Required clearance height
- H_{ri} = Trough inner height
- D = Overlength E-Chain® radius in final position
- K = $\pi \cdot R + \text{"safety"}$
- D₂ = Overlength - long travels, gliding
- K₂ = "Further add-on"
- H₂ = "Mounting height"

*if the mounting bracket location is set lower

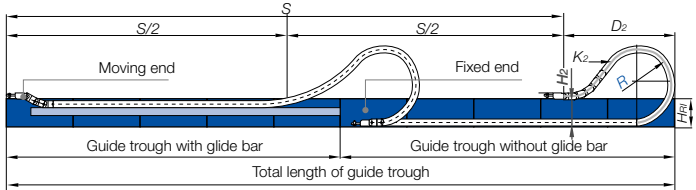

	R	150	200	250	300	350	400	450	500
H	390	490	590	690	790	890	990	1090	
D	286	336	386	436	486	536	586	636	
K	655	815	970	1125	1285	1440	1600	1755	
H ₂	*	180	180	180	180	180	*	*	
D ₂	*	1140	1470	1700	1950	2255	*	*	
K ₂	*	1820	2275	2639	3003	3458	*	*	

*upon request

Technical Data



Details of material properties

▶ page 1.38

Long travels	from 10 m up to max. 800 m
Speed max. rolling / acceleration max. rolling	max. 10 [m/s] / max. 50 [m/s ²]
Fill weight	max. 15 [kg/m]
Material - permitted temperature °C	igumid G / -40° up to +120° C
Flammability class, igumid G	VDE 0304 IIC UL94 HB

Additional Features



- Interior separation available - Series E4.56
- Extension link for heavy fill weights available
- Robust steel mounting brackets available
- Special P4 guide trough system available

▶ from page 7.68

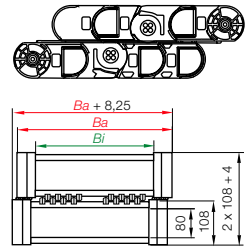
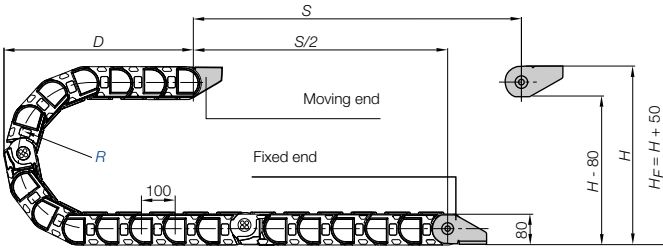

Series P4.80 - Rol E-Chain® with combstile AUTO-GLIDE cross bars

Part No.	Bi	Ba	R	Bending Radii	Weight [kg/m]
P4.80.20.□.0	200	276	150	200 250 300 350 400 450 500	≈ 8,46
P4.80.25.□.0	250	326	150	200 250 300 350 400 450 500	≈ 8,79
P4.80.30.□.0	300	376	150	200 250 300 350 400 450 500	≈ 9,02
P4.80.35.□.0	350	426	150	200 250 300 350 400 450 500	≈ 9,58
P4.80.40.□.0	400	476	150	200 250 300 350 400 450 500	≈ 9,93

The bending radii 150 200 400 450 500 are available upon request.

Delivery time: approx. 6-8 weeks after receipt of order!

Supplement Part No. with required radius. Example: P4.80.20. 250 □.0

0 = standard color, other colors ▶ page 1.39

Pitch = 100 mm/link Links/m = 10 (1000 mm) Chain length = $S/2 + K$

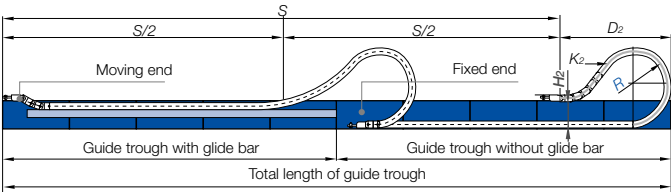

R	150	200	250	300	350	400	450	500
H	420	520	620	720	820	920	1020	1120
D	310	360	410	460	510	560	610	660
K	675	830	990	1145	1300	1460	1615	1775
H ₂	180	180	180	180	180	180	180	180
D ₂	955	1310	1610	1974	2060	2625	2910	3275
K ₂	900	1400	1800	2300	2700	3200	36000	4100

*upon request

Long travels	from 10 m up to max. 800 m
Speed max. rolling / acceleration max. rolling	max. 10 [m/s] / max. 50 [m/s]
Fill weight	max. 15 [kg/m]
Material - permitted temperature °C	igumid G / -40° up to +120° C
Flammability class, igumid G	VDE 0304 IIC UL94 HB

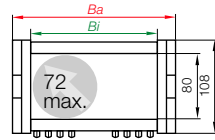

Part No. structure

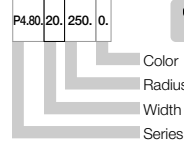

- S = Length of travel
- R = Bending radius
- H = Nominal clearance height
- H_F = Required clearance height
- H_{in} = Trough inner height
- D = Overlength E-Chain® radius in final position
- K = $\pi \cdot R$ + "safety"
- D₂ = Overlength - long travels, gliding
- K₂ = "Further add-on"
- H₂ = "Mounting height"

*if the mounting bracket location is set lower

Technical Data



Details of material properties

▶ page 1.38



Interior separation available - Series E4.80

▶ from page 7.82



Extension link for heavy fill weights available



Robust steel mounting brackets available



Special P4 guide trough system available

Additional Features



Rol E-Chain[®]

Rol E-Chain® - Rolling instead of gliding

E-Chains® are being used in ever longer travels. This has driven the development of the Rol E-Chain®. Additionally, movement speeds are increasing in combination with larger and larger fill weights (up to 50 kg/m). **Please contact us if you have decided for this product. We'll assist you in the project planning!**

- Major reduction in drive power to less than 25 % for moving the E-Chain®
- Travels up to 800 m possible
- Speeds up to 6 m/s possible
- Various roller types for optimum application adaption
- Can be used even in dirty environments
- Available as ready-to-fit, made-to-specifications system
- System guarantee for made-to-specifications systems

Application areas

The igus® Rol E-Chain® is designed for applications where long travels at high speeds have to be realized. This is, for instance, frequently the case with moving camera systems or material handling systems, even in the case of slower applications in the crane sector or travelling plants the low friction values of the system allow cost-savings, since the drives can be considerably smaller.

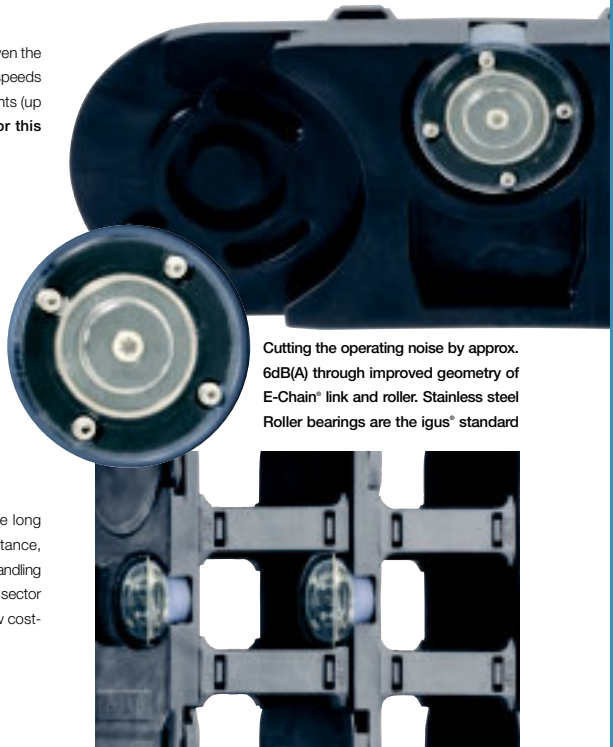

Cutting the operating noise by approx. 6dB(A) through improved geometry of E-Chain® link and roller. Stainless steel Roller bearings are the igus® standard

Roller extension link for higher additional weights and widths up to 2 m and more



Cross travel of 441.3 m, implemented with igus® Rol E-Chain® Series 5050R

Product Range Rol E-Chain®

Interior heights of 32, 42, 56 and 80 mm and widths of 50 mm up to several meters are possible and are available from stock. All interior separation options and mounting bracket variants of the igus® system E4 are available. The standard guide troughs of the relevant E-Chains® from stock can be used Rol E-Chains® can basically be opened along both radii. The Rol E-Chain® is available as a made-to-spec E-ChainSystem®. The Rol E-Chain® standard are stainless-steel ball-bearings. It is fitted with Chainflex® cables

and made-to-spec connectors and fittings in accordance with your requirements by igus® specialists and packaged in installation-friendly manner. Depending on the length of travel, the Rol E-Chain® can be delivered on a drum. If cables from the Chainflex® range are to be used, we will be more than willing to assume warranty for the full system. **Systems of this type should be designed by our system design engineers. We will be more than willing to submit an offer to you. Please contact us about this.**

Selection table

Series	Inner height <i>hi</i> [mm]	Inner width <i>Bi</i> [mm]	Outer width <i>Ba</i> [mm]	Outer height <i>ha</i> [mm]	Bending radius <i>R</i> [mm]	Chapter
Rol E-Chain® - with crossbars every 2nd link						
2828R	32	50 - 400	73 - 423	54	125 - 300	7
3838R	42	50 - 400	77 - 427	64	150 - 350	7
4040R	56	50 - 600	86 - 636	84	200 - 500	7
4040 RHD*	56	50 - 600	140 - 654	84	200 - 500	7
5050R	80	50 - 600	100 - 650	108	250 - 500	7
5050 RHD*	80	50 - 660	160 - 710	108	200 - 500	7
Rol E-Chain® - E-Tube, fully enclosed						
R7728R	32	50 - 300	73 - 323	54	250 - 300	7
R7838R	42	50 - 300	77 - 327	64	200 - 350	7
R8840R	56	75 - 462	111 - 499	84	300 - 500	7
R9850R	80	75 - 462	125 - 513	108	300 - 1000	7

- 4040 RHD* / 5050RHD* = extra stable version of Series 4040 and 5050
- 5050R: for E-Chain® widths up to 3000 mm with extension link/roller extension link
- Series 2828R, 3838R, 4040R, 5050R are also available as AUTO-GLIDE rollers
- Details on the appropriate E4/4 Series ► chapter 7 - System E4/4

Proven advantage: Reduce tensile strengths and shear forces by over 75% with igus® Rol E-Chain®

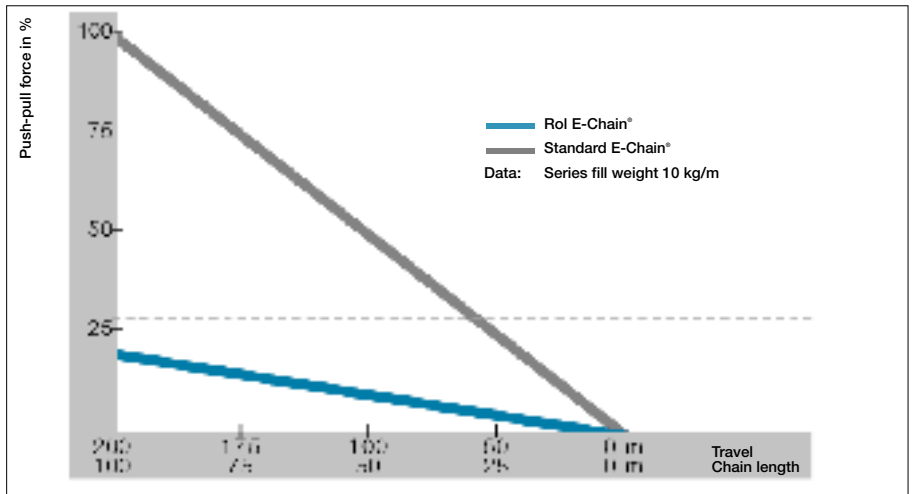

Comparison of the power requirement between Rol E-Chain® and a standard E-Chain®



igus® Rol E-Chain® Serie 5050R in a steel plant in India with highly corrosive atmosphere - $s = 22 \text{ m}$, $v = 1 \text{ m/s}$, $a = 1 \text{ m/s}^2$



Power plant application with igus® Rol E-Chain® 4040R - Travel 46 m, Speed 1.5 m/s, Fill weight 5.3 kg/m



Assembled system in a ship unloading crane with igus® 5050RHD - Travel 106 m, Speed 4 m/s, Fill weight 25 kg/m



Series 4040R on a coal unloading system - Travel 190 m, Speed 0.5 m/s, Fill weight 8.05 kg/m

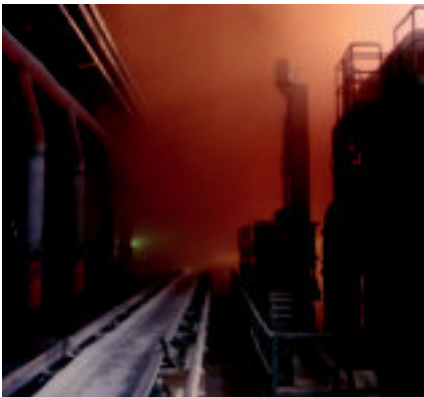

Series 4040R in steel works environment - Travel 10.5 m, Speed 60 m/min, Fill weight 6.084 kg/m



igus® E-Chains 5050RHD "Rol E-Chain"™ in an igus® super-alu-trough = 75% less driving power

Rol E-Chain®

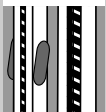
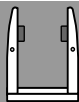
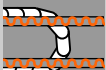
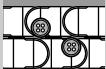
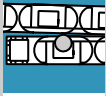

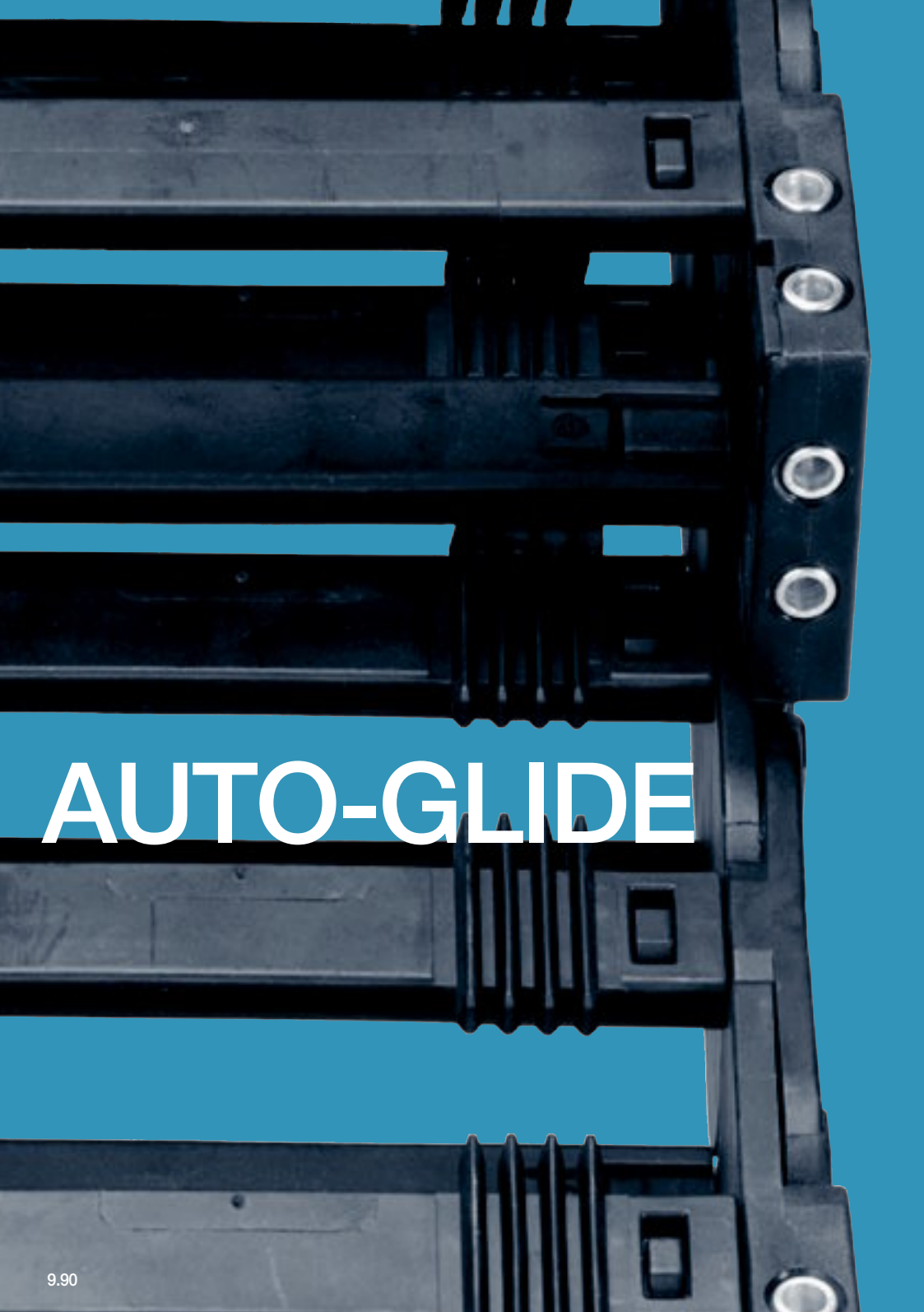

AUTO-GLIDE

AUTO-GLIDE:

Long travels are always demanding for an E-ChainSystem®. For much of the travel, the E-Chain must run on the lower run or on the glide bars. In addition the E-ChainSystem® needs guides, in order to prevent a sideward movement. In most cases this is ensured through a guide trough. However, there are also applications where a guide trough is not desired for space reasons, whether this is due to optical considerations or spatial conditions. In order to cater for this possibility, igus® developed the AUTO-GLIDE system in 1995. AUTO-GLIDE is a self-aligning E-Chain®, which can dispense with guide troughs for up to 50 m travel. You save acquisition and installation costs and can keep pathways in your warehouse free for lifts or industrial trucks.



In principle every igus® E-Chain® can be fitted out for the AUTO-GLIDE system. However, we recommend its use with E-Chain® whose interior height is less than 35 mm, and you should also consult us, since there are restrictions regarding the bending radii to be used

- Travels up to 50 m
- Travel speeds up to 1,5 m/s
- AUTO-GLIDE E-Chain® links of a piece, no additional parts required
- Very quick installation times for long travels
- Guide troughs not required!
- Small installation width, silent operation
- Functional guarantee for the entire system with Chainflex® cables

There are 4 options of the igus® AUTO-GLIDE system:

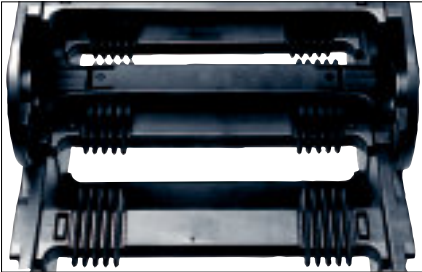

Option 1 - is available for almost all System E4 Series - here the crossbars in the interior radius of the E-Chain® are fitted with molded-on glide shoes

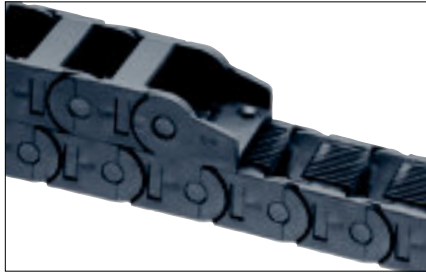

Option 2 - for Series 200 E-Chains: Injection-molded AUTO-GLIDE grooves in the inner radius. One-piece E-Chain® with firmly molded horizontal interior separation

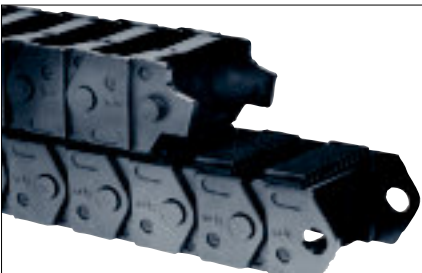

Option 3 - for igus® Easy Chain® E-Chain® combination of the easily fillable Easy Chain® and injection-molded AUTOGLIDE grooves in the inner radius

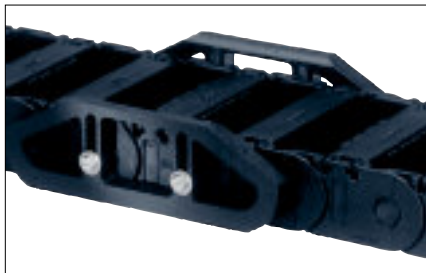

Option 4 - for Series E2/000 E-Chain® - Special plastic glide shoes side-mounted on the E-Chain® hold the E-Chain® "in the track"



Part No. structure

E4.56.21.	250.	0.	AG
-----------	------	----	----



System E4 AUTO-GLIDE variants

Part No.		Bi	Ba	R	Bending radius															
E4.32.20.	<input type="checkbox"/> .0.AG	200	223	100	125	150	175	200	220	250	300									
280.20.	<input type="checkbox"/> .0.AG	200	223	100	125	150	175	200	220	250	300									
2828.20.	<input type="checkbox"/> .0.AG	200	223	100	125	150	175	200	220	250	300									
E4.42.20.	<input type="checkbox"/> .0.AG	200	226	100	115	125	150	170	200	115	250	300	350							
380.20.	<input type="checkbox"/> .0.AG	200	226	100	115	125	150	170	200	115	250	300	350							
3838.20.	<input type="checkbox"/> .0.AG	200	226	100	115	125	150	170	200	115	250	300	350							
E4.56.15.	<input type="checkbox"/> .0.AG	150	184	135	150	175	200	240	250	300	350	400	500							
E4.56.21.	<input type="checkbox"/> .0.AG	150	184	135	150	175	200	240	250	300	350	400	500							
E4.56.25.	<input type="checkbox"/> .0.AG	150	184	135	150	175	200	240	250	300	350	400	500							
400.15	<input type="checkbox"/> .0.AG	150	184	135	150	175	200	240	250	300	350	400	500							
400.21	<input type="checkbox"/> .0.AG	212	249	135	150	175	200	240	250	300	350	400	500							
400.25	<input type="checkbox"/> .0.AG	250	284	135	150	175	200	240	250	300	350	400	500							
4040.15	<input type="checkbox"/> .0.AG	150	184	135	150	175	200	240	250	300	350	400	500							
4040.21	<input type="checkbox"/> .0.AG	212	249	135	150	175	200	240	250	300	350	400	500							
4040.25	<input type="checkbox"/> .0.AG	250	284	135	150	175	200	240	250	300	350	400	500							
E4.80.15.	<input type="checkbox"/> .0.AG	150	200	150	200	250	300	350	400	500	550	600	650	1000						
E4.80.21.	<input type="checkbox"/> .0.AG	150	200	150	200	250	300	350	400	500	550	600	650	1000						
E4.80.25.	<input type="checkbox"/> .0.AG	150	200	150	200	250	300	350	400	500	550	600	650	1000						
5050.15	<input type="checkbox"/> .0.AG	150	200	150	200	250	300	350	400	500	550	600	650	1000						
5050.21	<input type="checkbox"/> .0.AG	121	263	150	200	250	300	350	400	500	550	600	650	1000						
5050.25	<input type="checkbox"/> .0.AG	250	300	150	200	250	300	350	400	500	550	600	650	1000						

Supplement Part No. with required radius. Example: E4.56.21. 250.0.AG

Further widths on request - Delivery time: approx. 6-8 weeks after receipt of order!

Phone +49- (0) 22 03-96 49-800
Fax +49- (0) 22 03-96 49-222



Large gliding surfaces and good sliding behavior - Of one piece, no additional parts required

igus® GmbH
51147 Cologne



A glider and floor guides every 2 m completely replace a guide trough

Long travel without guide trough - Glider and floor guide

Simple guide elements for quick installation on the subsurface are available for the AUTO-GLIDE system version 1. The traversable eccentric floor guides are fastened every 2 m on the subsurface. The glider ② fastened on the moving end feeds the E-Chain® and holds this securely in the track. The AUTO-GLIDE crossbars ③ safely guide the E-Chain® and replace the guide trough. ● Save purchase and installation costs with this system ● Traversable over floor guide for travel distances over 10 m

Note: Only 2 gliders AG.XXX.OF are required for the safe feeding of the E-Chain®. The mounting of the glider is done on the outer link of the upper run, which is laid down first on the lower run.



Industrial trucks can run over the floor guides

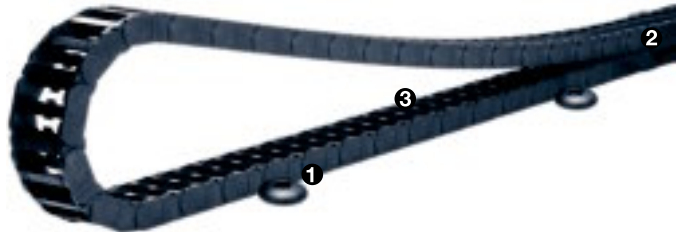

Part No. glider ②	For Series
AG.280.OF	E4.32 / 280 / 2828
AG.380.OF	E4.42 / 380 / 3838
Part No. floor guide ①	For Series
AG.380.BF	universal

Internet: www.igus.eu
E-mail: info@igus.de

Roller AUTO-GLIDE RAG

Special feature: Series 4040 and 5050 also available as rolling AUTO-GLIDE. For long travel and 75% less drive power (gliding application). We request for a consultation in case you have decided on this product.



System E4 Roller AUTO-GLIDE options

Part No.	Bi	Ba	R	Bending radius									
4040.28.	0.RAG	287	324	135	150	175	200	240	250	300	350	400	500
4040.36.	0.RAG	362	399	135	150	175	200	240	250	300	350	400	500
5050.28.	0.RAG	287	338	150	200	250	300	350	400	500	550	600	1000
5050.36.	0.RAG	362	413	150	200	250	300	350	400	500	550	600	1000

Supplement Part No. with required radius. Example: 4040.28.150.0.RAG

Comprehensive information for each E4 Series can be found at the relevant catalog page

Series	Inner-height hi	Outer-height ha	Page	Series	Inner-height hi	Outer-height ha	Page
E4.32	32	54	7.30	E4.56	56	84	7.50
280	32	54	7.132	400	56	84	7.152
2828	32	54	7.198	4040*	56	84	7.222
E4.42	42	64	7.40	E4.80*	80	108	7.60
380	42	64	7.142	5050*	80	108	7.242
3838	42	64	7.210	*Also available as AUTO-GLIDE E-Chain*			

Part No. structure

4040.28.250.0.RAG

AUTO-GLIDE
color
Radius
Width
Series

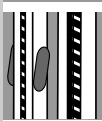
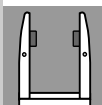
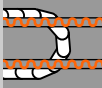
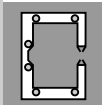
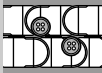
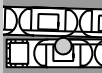
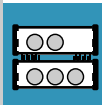

AUTO-GLIDE | Product Range | Option 2

Option 2: Series 200 - Molded AUTO-GLIDE grooves in the inner radius

One-piece E-Chain® with molded AUTO-GLIDE grooves in the inner radius. Available in one width, with molded horizontal interior separation.

- AUTO-GLIDE E-Chain® links are moulded and no additional parts are necessary
- Guide troughs not required!
- Narrow construction width, quiet running
- Function guarantee on the whole system with Chainflex® cables



Series AG200 - Combination: AUTO-GLIDE and E2 medium (Series 200)

Part No.	Bi	Ba	R	Bending radius									
AG200.05.	0	57	73.2	055	075	100	125	150	175	200	225	250	

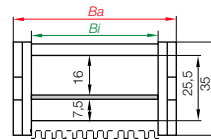

Supplement Part No. with required radius. Example: AG200.05.055.0

Pitch = 46 mm Links/m = 22 Chain length = S + K

R	055	075	100	125	150	175	200	225	250
H ⁺	145	185	235	285	335	385	435	485	535
D	125	150	170	195	220	245	270	295	320
K	276	346	414	496	578	660	742	814	920

The required clearance height is: $H_c = H + 25$ mm



Part No. structure

AG200.05.055.0.

AUTO-GLIDE
Color
Radius
Width



Option 3: As EA16 and EA25

The version 2 is a combination of AUTO-GLIDE version 1 and Easy Chain®. The grooves similar to tie-wrap plates are molded directly on the E-Chain® link and available at present in two sizes.

- AUTO-GLIDE E-Chain® links of a piece, no additional parts required
- Very quick installation times for long travels
- Guide troughs not required!
- Easy Chain® system: Cables and hoses can be inserted without opening the E-Chain®
- Small installation width, silent operation
- Functional guarantee for the entire system with Chainflex® cables

Series EA16 - Combination of AUTO-GLIDE and Easy Chain®

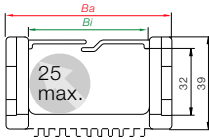

Part No.	Bi	Ba	R Bending radius
EA16.4. <input type="text"/> .0	48	60	<input type="text"/> 065 <input type="text"/> 075 <input type="text"/> 100

Supplement Part No. with required radius. Example: EA16.4. 065].0

Pitch = 30,5 mm Links/m = 33 Chain length = S + K

R	065	075	100
H	159	189	239
D	110	130	155
K	270	305	395

Part No. structure

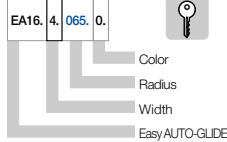

Series EA25 - Combination of AUTO-GLIDE and Easy Chain®

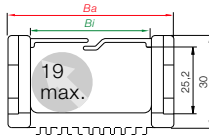

Part No.	Bi	Ba	R Bending radius
EA25.050. <input type="text"/> .0	50	60	<input type="text"/> 065 <input type="text"/> 075 <input type="text"/> 100

Supplement Part No. with required radius. Example: EA25.050. 075].0

Pitch = 25 mm Links/m = 40 Chain length = S + K

R	063	075	100
H	156	180	230
D	125	135	160
K	250	290	375

Part No. structure

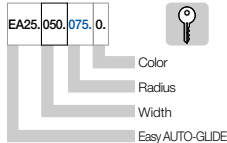

Option 4: For E-ChainSystem® E2 up to 35 mm inner height

In this version, special plastic glide shoes are side-mounted on the E-Chain® link every 1,000 to 2,000 mm. The function of these gliding shoes resembles the leeboards used on sail boats. Some of these leeboards are conceived in such a way that in contact they pivot upward and enable the continuation of the travel. Similarly the glide shoes in AUTO-GLIDE go up and down, each according to its position as lower run or upper run of the E-Chain®. They provide for the precise lateral guidance and a smooth gliding of the E-Chain® ● The first 4 m of the E-Chain® seen from the moving end needs no gliding shoes. From the fixed end of the E-Chain®, the glide shoes are **mounted on every 20th E-Chain® link** up to 4 m before the moving end ● Series 2400/2450/2480/2500 allow up to 15 m length without further glide shoes

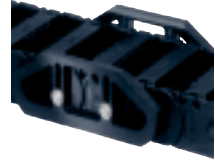

Series 2400/2450/2480/2500 - AUTO-GLIDE and System E2/000

Part No.		Bi	Ba	R	Bending radius														
2400/2450/2480/2500.02.	<input type="checkbox"/> .0.AG	25	41	055*	075*	100	125	150	175	200	225	250							
2400/2450/2480/2500.03.	<input type="checkbox"/> .0.AG	38	54	055*	075*	100	125	150	175	200	225	250							
2400/2450/2480/2500.05.	<input type="checkbox"/> .0.AG	57	73	055*	075*	100	125	150	175	200	225	250							
2400/2450/2480/2500.07.	<input type="checkbox"/> .0.AG	77	93	055*	075*	100	125	150	175	200	225	250							
2400/2450/2480/2500.09.	<input type="checkbox"/> .0.AG	89	105	055*	075*	100	125	150	175	200	225	250							
2400/2450/2480/2500.10.	<input type="checkbox"/> .0.AG	103	119	055*	075*	100	125	150	175	200	225	250							
2400/2450/2480/2500.12.	<input type="checkbox"/> .0.AG	125	141	055*	075*	100	125	150	175	200	225	250							

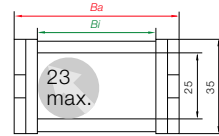

Supplement Part No. with required radius. Example: 2400.10.100.0.AG

Installation point = final travel

$$\text{Chain length} = S + K_2$$

Number of glide shoes =

$$\frac{\text{Chain length [m]} - 4 \text{ m}}{0,92 \text{ m}}$$

R	055*	075*	100	125	150	175	200	225	250
H	145	185	235	285	335	385	435	485	535
D	125	150	170	195	220	245	270	295	320
K	276	346	414	496	578	660	742	814	920

From R 100: with lowered mounting height!

*not for Series 2480

Part No. structure

2400.10.100.0. AG



Series 2600/2650/2680/2700 - AUTO-GLIDE and System E2/000

Part No.		Bi	Ba	R	Bending radius													
2600/2650/2680/2700.05.	<input type="checkbox"/> .0.AG	50	66	063*	075*	100	125	150	175	200	250							
2600/2650/2680/2700.06.	<input type="checkbox"/> .0.AG	65	81	063*	075*	100	125	150	175	200	250							
2600/2650/2680/2700.07.	<input type="checkbox"/> .0.AG	75	91	063*	075*	100	125	150	175	200	250							
2600/2650/2680/2700.09.	<input type="checkbox"/> .0.AG	90	106	063*	075*	100	125	150	175	200	250							
2600/2650/2680/2700.10.	<input type="checkbox"/> .0.AG	100	116	063*	075*	100	125	150	175	200	250							
2600/2650/2680/2700.12.	<input type="checkbox"/> .0.AG	125	141	063*	075*	100	125	150	175	200	250							
2600/2650/2680/2700.15.	<input type="checkbox"/> .0.AG	150	166	063*	075*	100	125	150	175	200	250							
2600/2650/2680/2700.17.	<input type="checkbox"/> .0.AG	175	194	063*	075*	100	125	150	175	200	250							

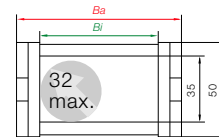

Supplement Part No. with required radius. Example: 2600.15.100.0.AG

Installation point = final travel

$$\text{Chain length} = S + K_2$$

Number of glide shoes =

$$\frac{\text{Chain length [m]} - 4 \text{ m}}{1,12 \text{ m}}$$

R	063*	075*	100	125	150	175	200	250
H	180	200	250	300	350	400	450	550
D	140	150	175	200	225	250	275	325
K	335	375	475	550	650	750	825	925

From R 100: with lowered mounting height!

*not for Series 2680

Part No. structure

2600.15.100.0. AG



A close-up photograph of a horizontal guide rail assembly. The assembly consists of a metal rail with a series of parallel grooves, mounted on a support structure. A black, flexible, braided cable is attached to the rail. The background is a solid, bright blue color. The text "Guidelok horizontal" is overlaid in white, bold, sans-serif font.

Guidelok horizontal

Upper run guide for long travels, self-supporting in chip areas

Especially for long travels on machine tools, if the E-Chain® has to be gliding, metallic chips are a problem. Guidelok horizontal is a cost-effective solution

- Travels, unsupported up to 50 m possible
- Chips cannot get stuck between upper and lower run
- Modular system with few parts
(also possible without sideways trough)
- Enormous increase of „self supporting“ length of E-Chains®
- Lower push-/pull forces (smaller E-Chains®, self supporting and rollers = energy efficient)
- Systeme Lower cost than most steel chains or sophisticated gliding systems
- Open guide trough design, chips can fall through

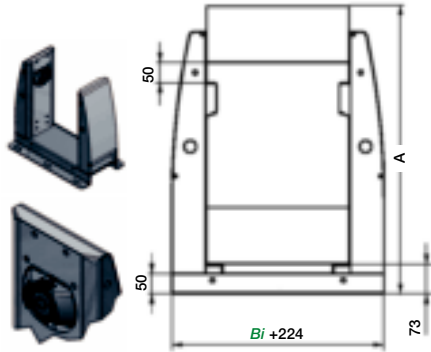

Typical industries and applications

- Machine tools
- Applications in the chip area
- Wherever a gliding application is not recommended

Design-principle - horizontal Guidelok guides the E-Chain® on special spring loaded roller supports, that are pushed back by the E-Chains® radius, clearing its path



The E-Chain® is guided in the trough channel, pushing back the spring loaded roller support with its radius...



...which snaps back out again after the E-Chain® radius has passed...



...the upper run then gets to lay on the roller support.

Guidelok horizontal | Product Range

LLLL = S

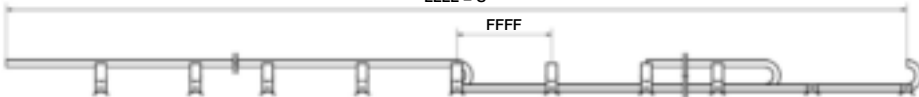

Principle sketch - Guidelok horizontal

Selection table

For Series	Bi	R Bending radius	Dim. A	Part No. horizontal trough with Guidelok	
E4.56/H4.56/R4.56	30	150	457	GLO.79.300.150.LLLL/FFFF	LLLL = Total length
E4.80/H4.80/R4.80	30	200	581	GLO.79.300.200.LLLL/FFFF	FFFF = Field length
600/601/R608	30	200	613	GLO.79.300.200.LLLL/FFFF	

For many more types (widths/radii) possible, due to the modular design - please contact us



Guidelok vertical

Guidelok vertical | For vertical energy supplies up to 80 m height



For vertical applications with lateral motion, igus® Guidelok vertical offers a simple, costeffective and safe system solution.

- Keeps hanging E-Chains in line - no swinging sideways
- No bouncing of E-Chains® in vertical applications with horizontal dynamics
- For high speed, acceleration and noise reduction
- E-Chain® is held in the trough by two rocking levers, activated by the chain loop
- Cost-effective, corrosion-free, light weight and for retroactive installation (hanging)
- Available immediately, for Series 2400/2500 and 2600/2700



Typical industries and applications

- Automated storage/retrieval systems
- Lifts
- Revolving storage systems
- Diagonal lifts
- All vertical applications

The problem: Suspended E-Chains® can swing sideways due to transverse acceleration. **The solution:** New "Guidelok vertical" system. E-Chain® stays on track even with high transverse acceleration! When the chain moves over the control button ❶ the fixing button ❷ is moved, the lower run of the E-Chain® held in place, preventing it swinging out. For elevators, racking units, material handling equipment.



Find a video online
▶ www.igus.de/GuideLok_Film

Guidelok vertical | Product Range

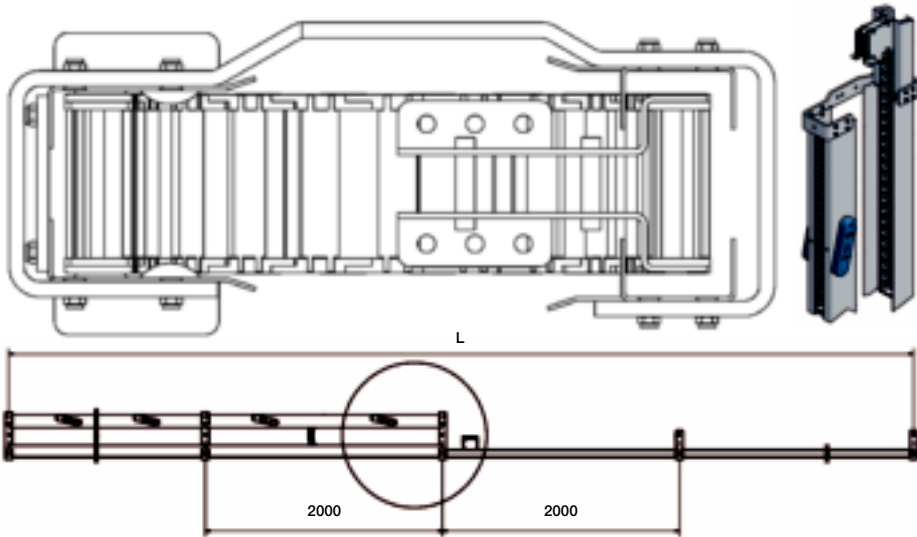

Principle sketch - Guidelok vertical

Selection table

For Series	Bi	R Bending radii	Part. No. vertical trough with Guidelok	L = total length/height
2400	07	150	GLC.2400.07.150.	L/2000
2600	07	200	GLC.2600.07.200.	L/2000
2600	15	200	GLC.2600.15.200.	L/2000
2828	137	200	GLC.2828.137.200.	L/2000
E4.32	137	200	GLC.E4.32.137.200.	L/2000

For many other series on request!



LBT Flizz[®]

LBT Flizz® - High speeds and accelerations

- Travels up to 200 m, speeds up to 8 m/s
- Applicable for moving and stationary control, ideal for all bus systems
- Good for applications needing low weight and good corrosion resistance
- Quiet and maintenance free operation
- At -35°C up to +80°C continuous temperature
- Accelerations over 10 m/s²
- Energy supply for all media, not only for electrical

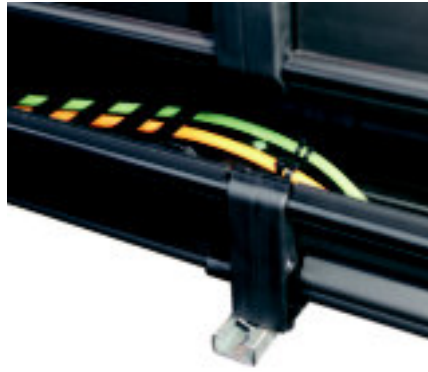

LBT Flizz® System

The complete system comprises the igus® E-Chain®, the LBT Flizz® guide trough and the igus® Chainflex® cables which can be fully made-to-spec on request. The LBT Flizz® guide trough consists of a modular system, based on extruded guide profiles and a supporting frame with continuous tubes for stabilization. All components are of corrosion-protection, made either extruded or powder-coated high-quality plastic. The materials used are resistant to weathering and resistant to most chemicals, oils, greases, coolants and solvents. The optionally fully enclosed design offers protection against dirt, leaves, ice and snow. Safety, function and freedom from maintenance with clear price advantages over conventional energy supply systems are the crucial criteria for selection.

Advantages of LBT Flizz®

- Guaranteed service life
- Cost-effective by comparison with conventional energy supply systems
- Protection of the cables against dirt, rain, sun, ice, snow and leaves (freezing up not possible)
- Insensitive to wind movement
- Resistant to chemicals and solvents etc.
- Use of special cables possible, e.g. servo-drive cables, fiber-optic cables and bus systems etc.
- Virtually maintenance-free
- Easy and fast installation since it supplied as a made-to-spec system
- Easy integration in existing systems
- Cable length 50 % of travel

Typical industries and applications

- Sludge scrapers
- Sand catchers
- Stormwater overflow tanks
- Electric plating plants
- Cranes
- Plant construction

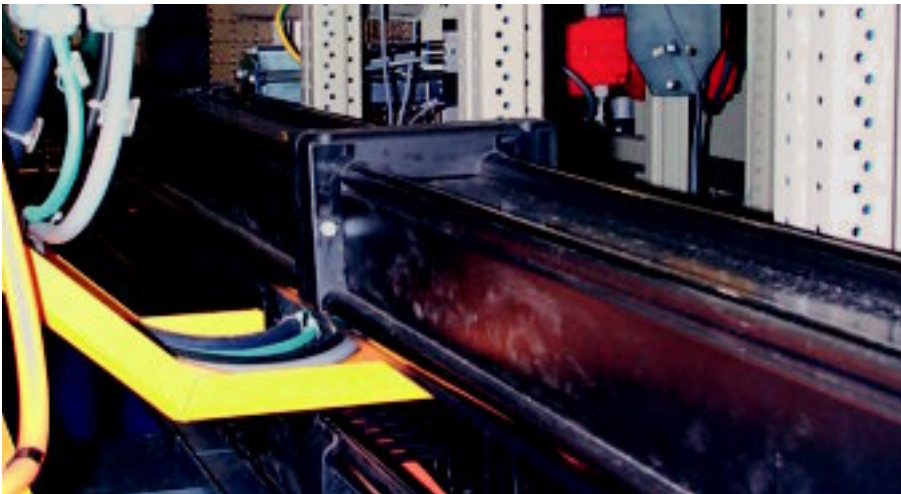

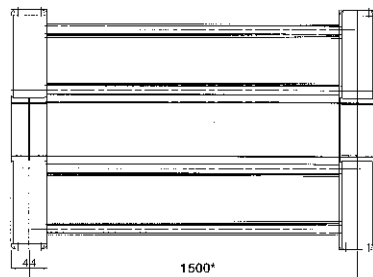
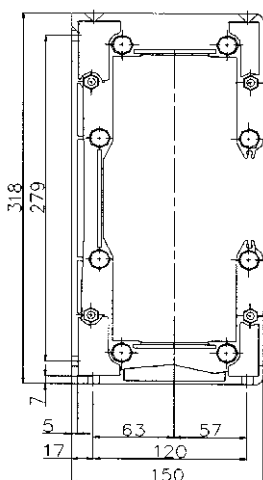
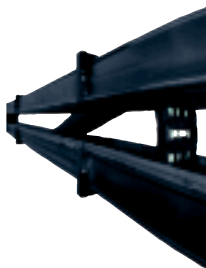

*required length: 1500 mm (more upon request)



Installation variant for
power infeed at fixed end

Design

- Solid plastic with powder-coated support tubes
- Modular design: the system can be closed with intermediate plates
- Can be supplied preassembled
- Variable bays which are simply screwed together
- Glide bar integrated in profile

Safe energy and data transfer

The igus® Chainflex® range of cables offers a selection from over 850 different cables available from stock. This includes power, signal, data and bus systems including fibre optic cables. In addition, we can offer you all supply cables for your drive systems, such as motor, servo cables and encoder cables; all can be supplied made-to-spec with connectors.

Cost-cutting installation

Thanks to the use of made-to-spec E-ChainSystems®, you can greatly reduce expensive time incurred for installation and assembly at the installation site. Function-tested systems guarantee fast commissioning of the powered system sections.

Installation service

We will be more than pleased to submit an offer to you for a full solution, including all installation services. This means that none of your own staff are tied up and, in future, you will have a trouble-free energy supply system at a fixed price.



Example of mounting
the console on jibs



The installation variant of a floating moving end for compensating for any lateral offset tolerances between scraper and E-ChainSystem®





The scraper moves on the 38 m long final clarifier in round-the-clock operation. The energy supply is done via the LBT Flizz® system



Space-saving and compact energy supply with LBT Flizz® - Maintenance system, delivered pre-assembled with assembled igus® E-Chain®



LBT Flizz® in a longitudinal scraper travel (S) = 38 m
 ● Speed (v) = 1.0 m/min. ● Acceleration (a) = 0.5 m/s²
 ● Cycle time 1.5 x hour/ 24 h/365 days



Energy supply system protected from wind and weathering. The used materials are weather-resistant, as well as resistant against most chemicals, oils, fats, coolants and solvents



igus® LBT Flizz® - Sewage works of the company Hydrobudowa S.A. in Poland. The power supply system of the scrapers in 8 clarifiers was equipped with igus® E-Chain® and LBT Flizz®. The complete system runs directly over the clarifier. Advantages: ● Low-maintenance system ● Longer service life ● Enclosed trough, protection against snow and ice ● Space-saving compared to conventional system ● Compact and safe ● Travel (S) = 42 m ● Assembled with igus® Chainflex® cables

System LBT Flizz®

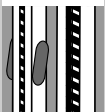
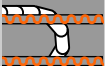
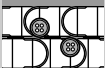
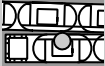

A detailed close-up photograph of a Micro Flizz cable management system. The system consists of a white plastic frame with a black, flexible, segmented track. The track is curved and features several circular indentations, each containing a small blue cable. The track is mounted to the white frame using screws. The background is a solid, vibrant blue color.

Micro Flizz®



Master long travels with the smallest E-Chain® without failures

- ONE compact system for a secure guidance of power, data and air
- Maintenance-free alternative for busbar
- E-Chain® is guided in special slot, no sliding against each other
- Control via stationary switch cabinet possible
- Accelerations up to 50 m/s² and speeds up to 6 m/s
- Fast assembly due to pre-configured, modular system
- Less space required
- Available also as pre-assembled
- Smooth running due to ball bearings in the guide carriages
- Also with EX tested E-Chain® available (on request)
- Rail material: anodized aluminum
- iF-Design Award

Cable diameter
MF06: max. Ø 8,0 mm
MF08: max. Ø 9,5 mm

Typical industries and applications

- Rack feeder ● Indoor cranes ● Industrial gates ● Working stations ● Sewage treatment plants ● Camera systems ● Sliding doors ● Operator panels ● Measure systems ● Studio equipment ● Conveyor technique



Special feature of the Micro Flizz® construction

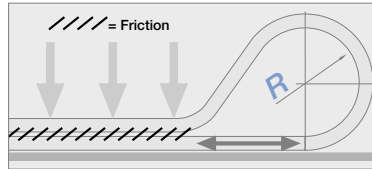

Yesterday: Moving lower run, sliding function. Long travels need stable E-Chains®.

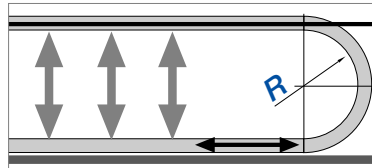

Today: Micro Flizz® - Small E-Chains®, self-guiding in guiding channel - Friction is reduced by factor 3 over the conventional system.

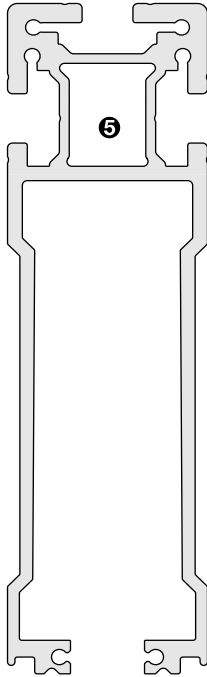

Technical data Micro Flizz®

- ① Separated upper and lower run of the Flizz® E-Chain®, thus less friction and reduced push/pull forces
- ② Winglets hold the E-Chain® secure in the guidance channel
- ③ Polymer springs for a soft unrolling of the E-Chain® in the Flizz® channel effect a substantial noise reduction
- ④ Integrated strain relief in the guide carriage for the safe fixing of cables
- ⑤ Universal attachment options due to three T-grooves
- ⑥ Attachment of the E-Chain® by roller cart on the moving end, gliding or locking possible
- ⑦ Opposed E-Chains® can be used, that means a double filling or two independent travels are possible

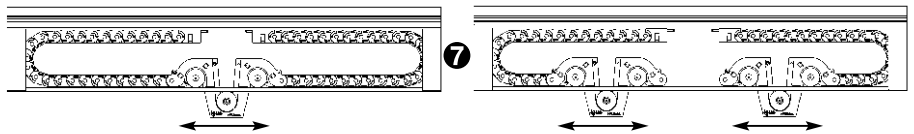
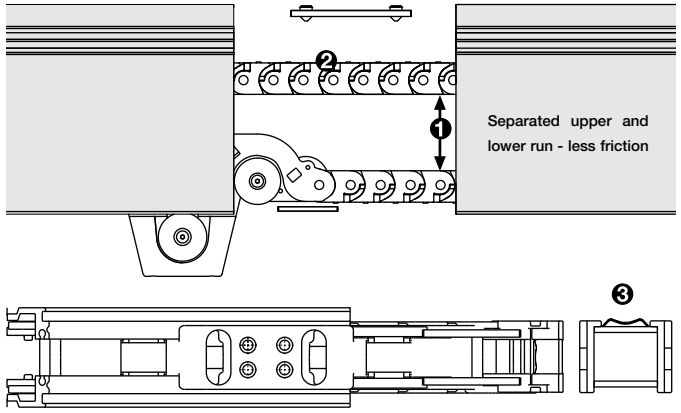

Details Micro Flizz®



Separated upper and lower run: Running trough the radius, integrated winglets fold in

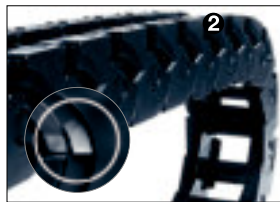

In the extended position, the winglets fold out and safely hold the upper run in the elevated position

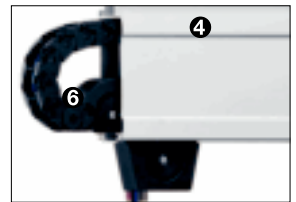

Power, data, pneumatics in confined areas. Chainflex® cables are specifically designed for this challenge

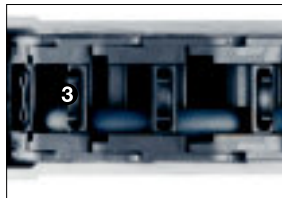

A polymer spring element cushions the motion inside the trough and lower noise



Micro Flizz® accessory:
 Connection for compressed air coupling



Potential application area of the Micro Flizz® - Storage and retrieval units for high-bay warehouses, indoor cranes, etc.

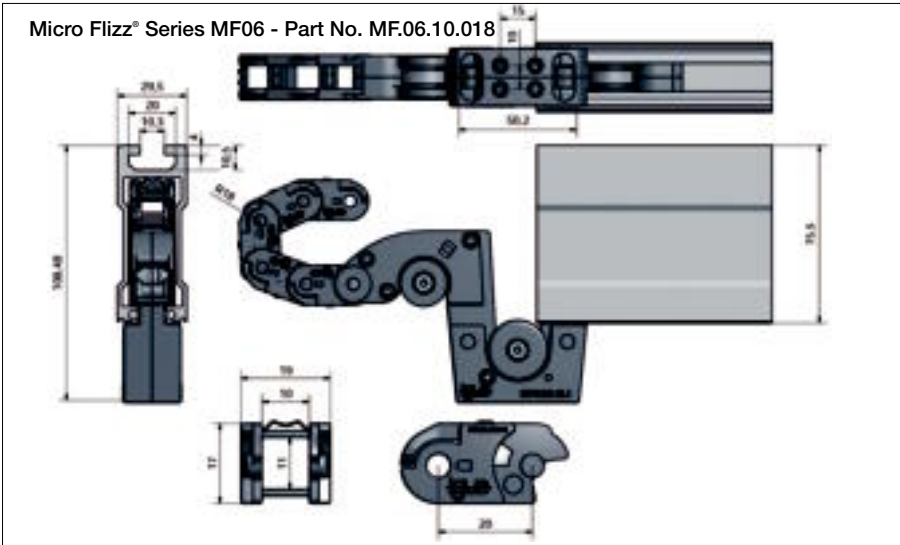

Micro Flizz® Series MF06 - Dimensions

Part No.	Bi	Ba	hi	ha	R Bending radius
MF.06.10.018	10	19	11	17	018

order example ► next page

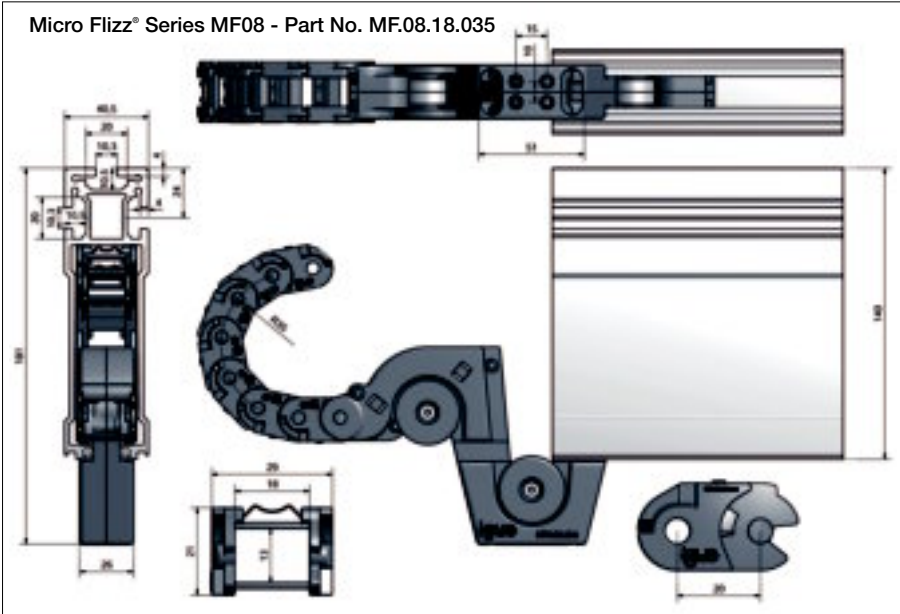

Micro Flizz® Series MF08 - Dimensions

Part No.	Bi	Ba	hi	ha	R Bending radius
MF.08.18.035	18	29	13	21	035

order example ► next page



Order example - End feed

MF	06.	10.	018.	L / F
----	-----	-----	------	-------

MF06.10.018.5000/2000 Series MF06

MF	08.	18.	035.	L / F
----	-----	-----	------	-------

MF08.18.035.5000/2000 Series MF08

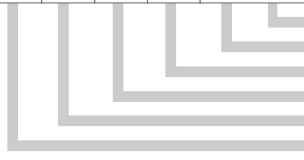

- F = Field length [mm]
- L = Total length [mm]
- R = Bending radius [mm]
- Bi = Inner E-Chain® width
- Type (Series)
- Micro Flizz® end feed

Calculate the number of required channel pieces (n) thus:
 $n = \frac{L}{F}$
 Then round off the result.

Micro Flizz® as end feed option with a total length of 5000 mm, split into 2 channels each 2000 mm and 1 channel with a residual length of 1000 mm

- Bi = Inner E-Chain® width [mm]
- R = Bending radius [mm]
- n = Number of channel pieces
- S = travel = L - 300 [mm]
- F = Field length [mm]
- L = Total length [mm]
- X = residual length [mm]

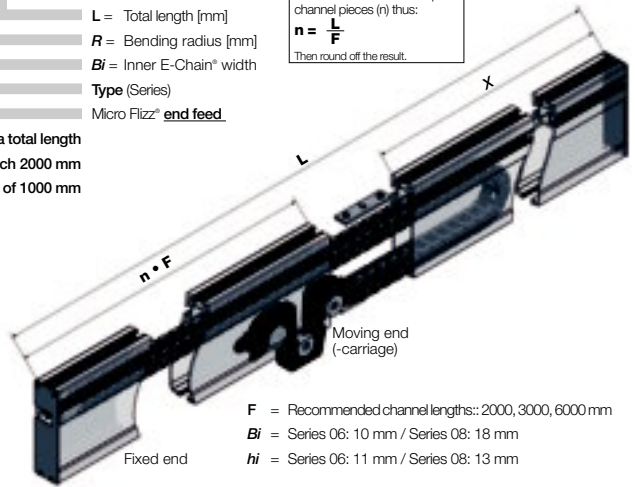

- F = Recommended channel lengths:: 2000, 3000, 6000 mm
- Bi = Series 06: 10 mm / Series 08: 18 mm
- hi = Series 06: 11 mm / Series 08: 13 mm



Order example - 2 carriages in opposite directions

MFG2	06.	10.	018.	L / F
------	-----	-----	------	-------

MFG2.06.10.018.10000/3000 Series MF06

MFG2	08.	18.	035.	L / F
------	-----	-----	------	-------

MFG2.08.18.035.10000/3000 Series MF08



- F = Field length [mm]
- L = Total length [mm]
- R = Bending radius [mm]
- Bi = Inner E-Chain® width
- Type (Series)
- Micro Flizz® 2 carriages

Calculate the number of required channel pieces (n) thus:
 $n = 2 \cdot \frac{L - 200}{2 \cdot F}$
 Then round off the result.



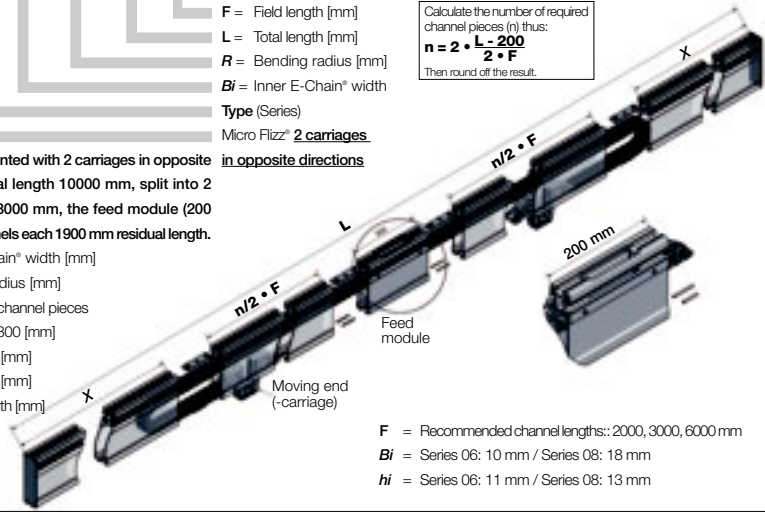

Micro Flizz® mounted with 2 carriages in opposite directions - Total length 10000 mm, split into 2 channels each 3000 mm, the feed module (200 mm) and 2 channels each 1900 mm residual length.

- Bi = Inner E-Chain® width [mm]
- R = Bending radius [mm]
- n = Number of channel pieces
- S = travel = L - 300 [mm]
- F = Field length [mm]
- L = Total length [mm]
- X = residual length [mm]

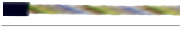

- F = Recommended channel lengths:: 2000, 3000, 6000 mm
- Bi = Series 06: 10 mm / Series 08: 18 mm
- hi = Series 06: 11 mm / Series 08: 13 mm

Highly flexible Chainflex® special cables for dynamic applications

Chainflex®	Temp. [°C]	v max. unsupported	v max. gliding	a max.	Number of cores	Diameter ø [mm]
 CF.9	-35°C - +100°C	10 m/s	6 m/s	100 m/s²	2 - 36	0,25 - 35,0
 CF.10	-35°C - +100°C	10 m/s	5 m/s	100 m/s²	2 - 25	0,14 - 4,0
 CF.98	-35°C - +90°C	10 m/s	6 m/s	100 m/s²	2 - 8	0,14 - 0,5
 CF.99	-35°C - +90°C	10 m/s	6 m/s	100 m/s²	2 - 8	0,14 - 0,34

Chainflex®	Temp. [°C]	v max. unsupported	a max.	Number of cores	Diameter ø [mm]
 CF.FLAT	-35°C - +90°C	10 m/s	*	1	2,5 - 50,0

*up on request

Chainflex® cables suitable for Micro Flizz® are available from stock at igus®!

MF06 - max. cable outer diameter ø 8,0 mm, MF08 - max. cable outer diameter ø 9,5 mm

igus® Micro Flizz®

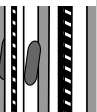
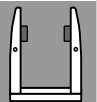

Ask for your free updated Chainflex® catalog at: www.chainflex.eu



Micro Flizz® in an outdoor application with 30 m travel



Energy supply to the strip at cold storage house doors, in operation for more than one year.



Micro Flizz® as "energy supplying rail guide" of a scale to weigh chemicals, etc.



Safe energy supply also under strong dust and dirt accumulation with igus® Micro Flizz®



● $s = 8,5 \text{ m}$ ● $v = 4 \text{ m/s}$ ● $a = 4 \text{ m/s}^2$ ● Filling: 1x CF9.15.04 ● Running performance ca. 15.000 km without failure (issue 06.2006)



● $s = 40 \text{ m}$ ● $v = 4 \text{ m/s}$ ● $a = 1 \text{ m/s}^2$ ● $m_{\text{Chain}} = 0,21 \text{ kg/m}$ ● $m_{\text{Cable}} = 0,09 \text{ kg/m}$ ● Filling: 1 x CF98.05.04

igus® Micro Flizz®

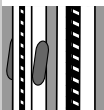
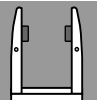
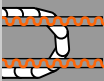
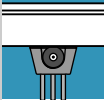
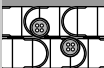
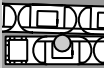



LeviChain

LeviChain - magnetic E-ChainSystem® - it "floats"

The principle of the magnetic "floatation" is based on the attractive forces of the prevailing magnetic field, which "centers" the E-Chain® in all directions. By this "centering" the E-Chain® moves almost contactless with favorable friction and wear behavior and minimum abrasion.

- Long travel possible without laying the E-ChainSystems® on top of each other
- Almost no abrasion and very low wear due to low-abrasion E-Chain® links (without pin/hole connection) as well as almost contactless movement of the E-Chain®
- Compared to other energy supply systems, the igus® System LeviChain is extraordinarily low noise [41.7 dB (A) in 1 m distance], as there is almost no rolling or sliding noise
- High speeds and accelerations are possible
- Simple assembly, even as a retrofit
- Variable installation positions (horizontal and vertical) possible
- Little space requirement in height and width
- IPA certificate



Long travels up to 40 m with high speeds and accelerations, almost contactless, with the igus® LeviChain

Typical industries and applications

- Cleanrooms
- Painting works/plants
- Medical technology
- Measuring technology
- Electronic manufacturing
- Automated storage and retrieval systems
- Material handling
- Industrial robots

Applications-LeviChain

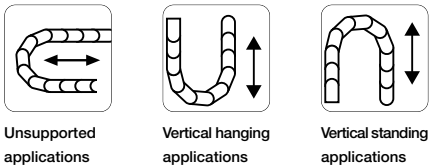

Simple insertion of cables through the proven and tested "Easy" design

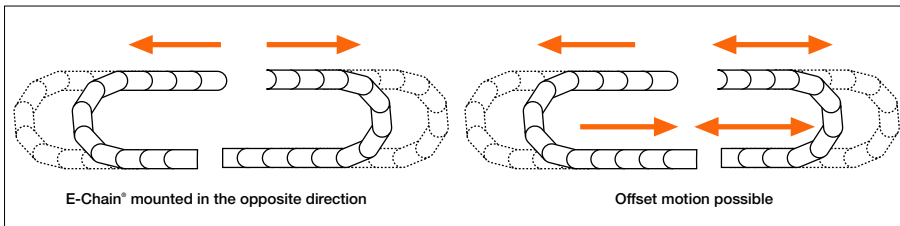



LeviChain also available as 2- and 3-strip E-Chain®



Three-strip E-Chain® assembled with igus® Chainflex® cables



Design LeviChain - Schematic diagram of the magnetic forces

Phone +49- (0) 22 03-96 49-800
Fax +49- (0) 22 03-96 49-222

igus® GmbH
51147 Cologne

Internet: www.igus.eu
E-mail: info@igus.de

Virtually contactless energy supply for long travels - low noise, low wear, safe and available!



- ① Modular igus® E-Chain® different widths and bending radii
- ② Contactless guidance of upper run and (optional) lower run
- ③ Support elements
- ④ Magnet modules

Values for 1-, 2-, 3-strip E-Chains®:

- Max. additional load 4 kg/m
- Travel: 40 m



Unsupported application for very long travels. The upper and lower runs are not laid on top of each other on long travels. The lower run can also be guided "floating" without contact. Max. additional load up to 4 kg/m. Travels up to 40 m possible.

Technical Data

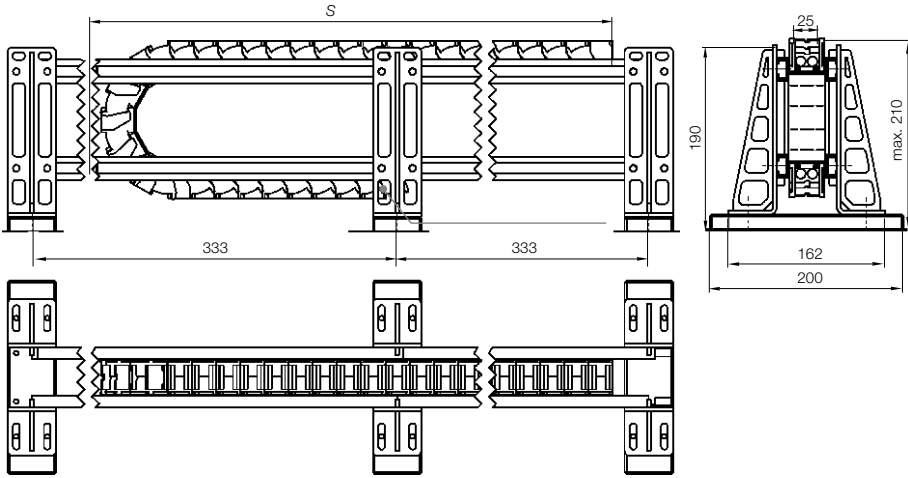

igus® LeviChain

Product Range

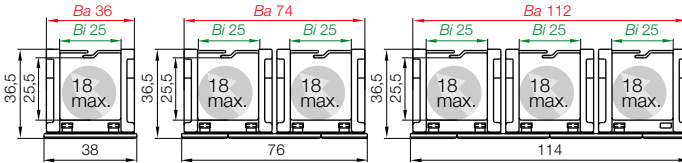

LeviChain - Dimensions

Part No.	Bi	Ba	hi	ha	R Bending radius
LV.25.25.....	25	36	25,5	36,5	045 063 075 100 125 150 175 200
LV.25.2/25.....	2 x 25	74	25,5	36,5	045 063 075 100 125 150 175 200
LV.25.3/25.....	3 x 25	112	25,5	36,5	045 063 075 100 125 150 175 200

Upon request - Delivery time: approx. 4-6 weeks after receipt of order!

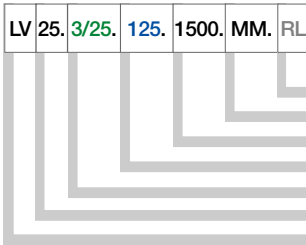

Part No. structure - LeviChain
 LV.25.3/25.125.1500.MM*.RL

- Option RL: E-Chain® counter run (E-Chain® right and left)
- Magnetic module: M = Magnetic module / B = Delivery plate / MM = Magnetic module top/bottom / MB = Magnetic module top, delivery plate bottom
- Travel S: min. 1000 mm - in 25 mm steps
- Bending radius R
- 1-, 2-, 3-Band-E-Chain® and inner width Bi
- Inner height hi
- Series: igus® LeviChain-System

Band-E-Chain LV.25.3/25.125.1500.MM.RL - LeviChain as 3-strip model and magnetic modules mounted top/bottom

*Please contact us if you need a different configuration.

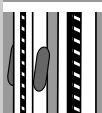
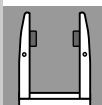
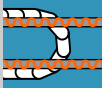
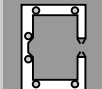
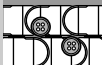
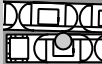
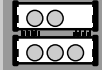

igus® modular system for projects

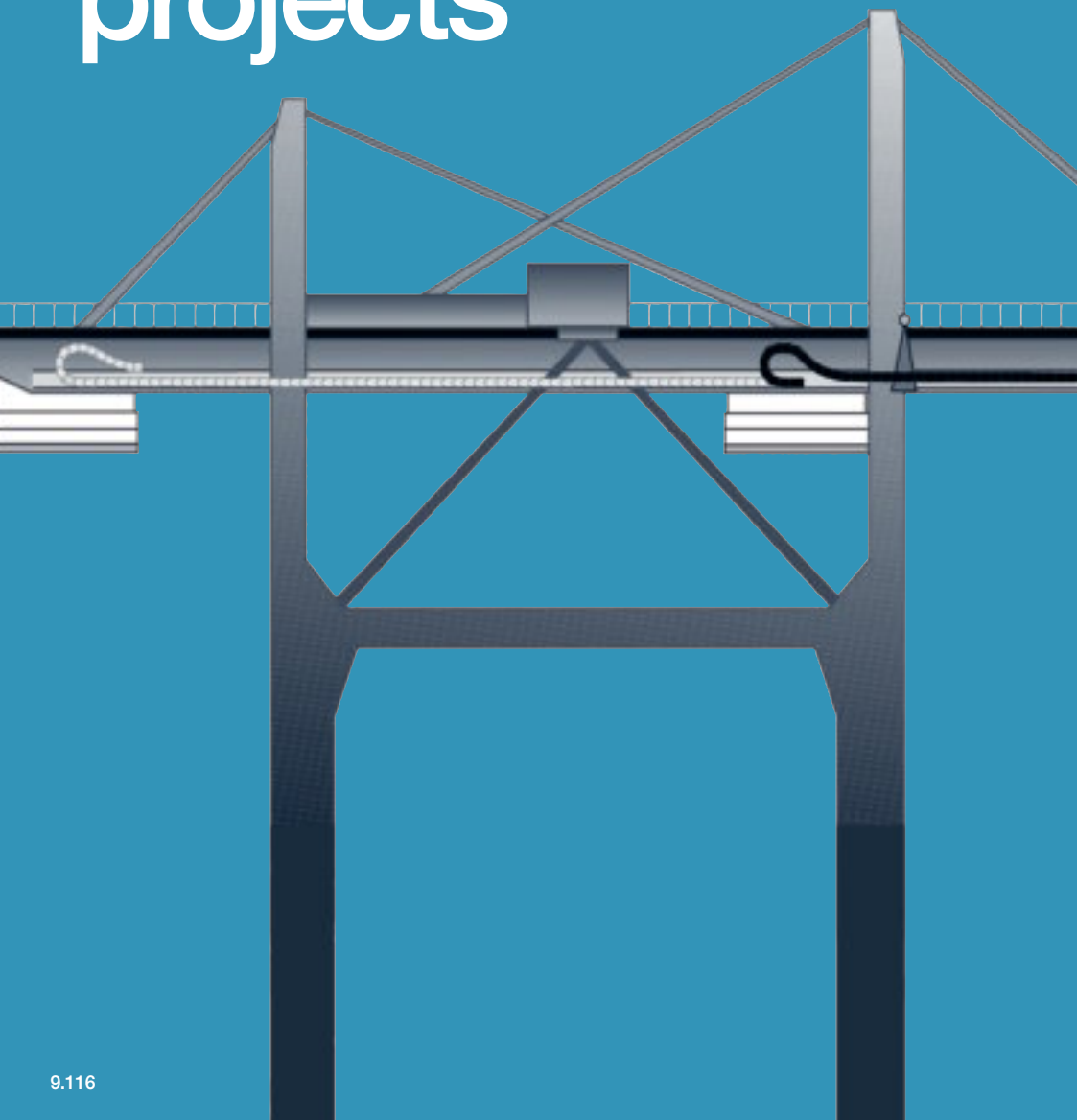

The igus® modular system for projects - special components, tested and time-proven in numerous projects, have now become available as a modular standard system.

- Faster quotations
- Faster project planning
- Detailed service manuals and documentation
- Time and cost savings
- Safe function
- System warranty available upon request, for individual applications

Available modules of such a modular system for projects entail, for example:

- PPDS tow arm with electronic push/pull force monitoring
- Fixation point modules for easy attachment of the E-Chain® inside the guide trough, with no drilling required
- Extreme gliders gliding elements for even longer cycle life of E-Chains® on long travels
- HD "heavy duty" trough systems from various materials and with different assembly kit designs, matching the respective application and stress levels

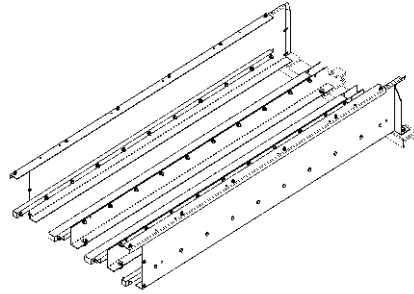

igus® project planning example, here: guide trough modules

Typical industries and applications

Cranes, offshore and many more

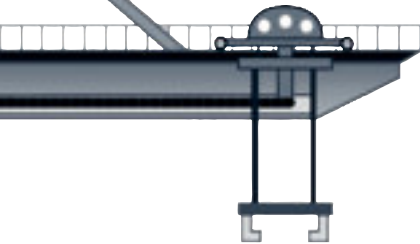

Long travels with electronics Push/Pull-force monitoring with the igus® PPDS System



igus® supervisors plan projects worldwide



Crane system designed by igus®



Chainfix

Strain Relief



Chainfix clamps and stainless-steel clamps - for maximum pull forces



Product	ø [mm]	Page
Clamps and saddle clamp elements	from - to	
Single clamp housing*, including top/bottom saddle clamps	6 - 42	10.5
Double clamp housing*, incl. top/bottom saddle clamps and 1 stacker saddle clamp	6 - 34	10.5
Triple clamp housing*, incl. top/bottom saddle clamps and 2 stacker saddle clamp	6 - 22	10.5
Chainfix Multi-Clamps*	6 - 12	10.6

*Standard material steel zinc-coated. Stainless-steel version also available (1.4301)

Chainfix tiewrap plates - for universal tiewrap, bolted or clip-on



Product	Page
Chainfix tiewrap plates	
Option 1: Chainfix tiewrap plates as single parts Series 2000	10.8
Option 1: Chainfix tiewrap plates as single parts Series 3000	10.8
Cable tiewraps	10.8

Chainfix tiewrap plates - for strain relief with cable tiewraps for C-profile



Product	Page
Chainfix tiewrap plates	
Option 2: Tiewrap plates with clip-on connection for the C-profile	10.9
Option 3: Clip-on tiewrap plates for opening or fixed crossbars	10.9
Option 4: Integrated strain relief for E2 Tubes - Series R	10.9

Chainfix Clips - high pull forces, plug-in



Product	ø [mm]	Page
Chainfix Clips	from - to	
Available for all igus® E-ChainSystems® with C-profiles and also suitable for assembly in the KMA mounting brackets and Clip-on strain relief for crossbars	04 - 24	10.10

Chainfix nuggets - for top hat rail and C-profile



Product	ø [mm]	Page
Chainfix Nuggets		
Option 1: completely simple and universal cable fixation, for diameter with Ø 20 mm and Ø 30 mm	≤ 30	10.10
Option 2: Fastening through clipping onto standard top hat rail	≤ 20	10.10

Chainfix strain relief separators - with integrated teeth



Product	Page
Chainfix strain relief separators	
Separator with integrated strain relief - easy strain relief with tie wrap	10.11

Blocks - Special strain relief for hoses. A Modular, space-saving system



Product	Page
blocks	
Strain relief for hoses, modular, space-saving system	10.11

E-Chain® Series	Chainfix					Chainfix tiewrap plates						
	Clamp ¹⁾	Clip C-profile ¹⁾	Clip cross-bar ¹⁾	Nugget ¹⁾	Strain relief separator ²⁾	Single part 2000 ²⁾	Single part 3000 ²⁾	Clip-on for C-profile ²⁾	Fixed crossbar ²⁾	Cross-bar ²⁾	For Triflex ²⁾	For E-Tube ²⁾
Triflex®												
Easy Triflex®											E33X.XX.Z	
Triflex®											33X.XX	
Easy Chain®												
E/Z200						20XX.ZB			2050.Z			
E/Z26							30XX.ZB					
E/Z300							30XX.ZB					
E2/000												
1400/1500						20XX.ZB						
1450/1480						20XX.ZB						
2400/2500					2020.Z	20XX.ZB			2050.Z			
2450/2480					2020.ZR	20XX.ZB						
2600/2700	X	X		X	262.Z		30XX.ZB	30XX.ZC	2050.Z	2050.Z		
2650/2680	X	X		X			30XX.ZB	30XX.ZC		2050.Z*		
3400/3500	X	X		X	301.Z		30XX.ZB	30XX.ZC	30XX.Z	30XX.ZS		
3450/3480	X	X		X	34501.Z		30XX.ZB	30XX.ZC		30XX.ZS*		
255						20XX.ZB						
E2 E-Tubes												
R117/118						20XX.ZB						
R157/158					1585.01.Z							
R167/168					1685.01.Z							
R48					481.ZR	20XX.ZB						
R58											5850.Z	
R68											30XX.Z	
E4.1												
E4.21					T2103.Z							
E4.28/R4.28						20XX.Z			2050.Z			
E4.32/H4.32/R4.32	X	X		X			30XX.ZB	30XX.ZC		3850.ZS		
E4.42/H4.42/R4.42	X	X		X			30XX.ZB	30XX.ZC		3850.ZS		
E4.56/H4.56/R4.56	X	X	X	X			30XX.ZB	30XX.ZC		45XX.ZS		
E4.80/H4.80/R4.80	X	X	X	X			30XX.ZB	30XX.ZC		45XX.ZS		
1640/R1608				X			30XX.ZB					
800							30XX.ZB					
840				X			30XX.ZB					
E4/00												
210					T2103.Z							
220/R760						20XX.Z			2050.Z			
280/290/R770	X	X		X			30XX.ZB	30XX.ZC		3850.ZS		
380/390/R780	X	X		X			30XX.ZB	30XX.ZC		3850.ZS		
400/410/R880	X	X	X	X			30XX.ZB	30XX.ZC		45XX.ZS		
600/601/R608				X			30XX.ZB					
640				X			30XX.ZB					
E4/4												
2828/2928/R7728	X	X		X			30XX.ZB	30XX.ZC		3850.ZS		
3838/3938/R7838	X	X		X			30XX.ZB	30XX.ZC		3850.ZS		
4040/4140/R8840	X	X	X	X			30XX.ZB	30XX.ZC		45XX.ZS		
5050/5150/R9850	X	X	X	X			30XX.ZB	30XX.ZC		45XX.ZS		
E4/light												
14040/14140/R18840	X	X	X	X			30XX.ZB	30XX.ZC		45XX.ZS		
14240/14340	X	X		X			30XX.ZB	30XX.ZC		3850.ZS		
15050/15150/R19850	X	X	X				30XX.ZB	30XX.ZC	X	45XX.ZS		
E6												
E6.29					E6.29.02.Z	20XX.ZB						
R6.29						20XX.ZB						
E6.35					E6.35.02.Z	20XX.ZB						
E6.40	X	X		X	E6.40.02.Z	20XX.ZB						
E6.52	X	X		X			30XX.ZB	30XX.ZC		3850.ZS		
R6.52	X	X		X			30XX.ZB	30XX.ZC				
E6.62	X	X		X			30XX.ZB	30XX.ZC		3850.ZS		
E6.80L	X	X	X	X			30XX.ZB	30XX.ZC		45XX.ZS		
E6.80	X	X	X	X			30XX.ZB	30XX.ZC		45XX.ZS		

■ = Recommended strain relief for selected E-Chain® *only half E-Tube

¹⁾ you'll find on ► page 10.4 ²⁾ you'll find on the product page of each E-Chain® Series

**For Series:****System E2/000**

- 2600/2650/2680/2700
- 3400/3450/3480/3500

System E4.1

- E4.32/H4.32/R4.32
- E4.42/H4.42/R4.42
- E4.56/H4.56/R4.56
- E4.80/H4.80/R4.80

System E4/00

- 280/290/R770
- 380/390/R780
- 400/410/R880

System E4/4

- 2828/2928/R7728
- 3838/3938/R7838
- 4040/4140/R8840
- 5050/5150/R9850

System E4/light

- 14040/14140/R18840
- 14240/14340
- 15050/15150/R19850

System E6

- E6.40
- E6.52 / R6.52
- E6.62
- E6.80L / E6.80

**Strain relief elements with Chainfix clamps and saddle clamp elements**

The Chainfix clamp system design principle has proven itself as effective, life-prolonging strain relief forigus® E-ChainSystems®. Clamps are the best solution for all E-Chains® with a KMA-mounting brackets with C-profile option. **Product range:** ● Chainfix clamp housing with setscrew and top saddle clamp; bottom saddle clamp; stacker saddle clamp ● C-profile **Materials:** Clamp housing: Black lacquered steel, setscrew: Black steel, saddle clamps: igumid G

Important improvements are offered by igus® exclusive Chainfix products:

- Optimal igus® Chainfix housing with reduced height
- Long service life for dynamic applications thanks to improved clamping elements
- Integration with KMA mounting brackets:
 - Saves both time and space during installation
 - Available for complete systems with cables and strain relief
- Improved clamping foot for easier fit in the C-profile Ideally, the cables/hoses should be strain relieved at both ends of the E-Chain®
- Improved housing foot clamp for easy fit into C-profile
- Housing with reduced overall height
- Black housing and setscrews for attractive appearance
- Setscrews, tightened with Allen wrench, for easy installation

Overall height restrictions

If the E-Chain® glides on itself over long travel distances, the screw heads of the strain relief on the fixed end must be at least 10 mm below the E-Chain® link height. Our clamp housing with setscrews reduces the overall height by up to 15 mm compared to conventional clamp housings. In the case of unsupported E-Chains®, the strain relief elements may be used with no problems. When using Chainfix clamps on C-Profile in the mounting bracket for Series 280, 2828, 28, 290, 2928, 29, R770, R7728, R77 a shortened mating trough must be used. The Part No. for this is: CFX...K (add letter "K" to the above Part No.)



Setscrew and reduced optimal housing height for use in long-/gliding travel applications



Improved housing foot clamp for easy fit into C-profile rail

Note:

- Ideally, the cables/hoses should be strain relieved at both ends of the E-Chain®. At the very least, they must be strain relieved **at the moving end of the E-Chain®**.
- When using Chainfix clamps on C-Profile in the mounting bracket for Series 280, 2828, 290, 2928, R770, R7728 a **shortened mating trough must be used**. The Part No. for this is: CFX...K (add letter "K" to the above Part No.)

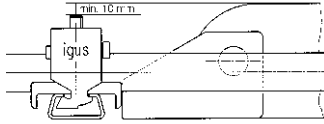
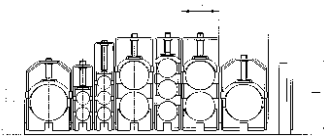

The dimensions given for H in the tables are based on the maximum cable diameter. Cables with smaller diameters may result in lower overall clamp housing heights.

Single clamp housing, incl. top/bottom saddle clamps

Part No.	Part No.	ø	B ^{±2}	H	Part No.	Part No.	ø	B ^{±2}	H
Steel	Stainless steel*	[mm]	[mm]	[mm]	Steel	Stainless steel*	[mm]	[mm]	[mm]
CFX12.1	CFX12.1.E	06 - 12	16	58	CFX26.1	CFX26.1.E	22 - 26	30	67
CFX14.1	CFX14.1.E	12 - 14	18	50	CFX30.1	CFX30.1.E	26 - 30	34	71
CFX16.1	CFX16.1.E	14 - 16	20	52	CFX34.1	CFX34.1.E	30 - 34	38	75
CFX18.1	CFX18.1.E	16 - 18	22	54	CFX38.1	CFX38.1.E	34 - 38	42	79
CFX20.1	CFX20.1.E	18 - 20	24	56	CFX42.1	CFX42.1.E	38 - 42	46	83
CFX22.1	CFX22.1.E	20 - 22	26	58					

*Material stainless steel: 1.4301



Double clamp housing, incl. top/bottom saddle clamps and stacker saddle clamp

Part No.	Part No.	ø	B ^{±2}	H	Part No.	Part No.	ø	B ^{±2}	H
Steel	Stainless steel*	[mm]	[mm]	[mm]	Steel	Stainless steel*	[mm]	[mm]	[mm]
CFX12.2	CFX12.2.E	06 - 12	16	72	CFX22.2	CFX22.2.E	20 - 22	26	90
CFX14.2	CFX14.2.E	12 - 14	18	74	CFX26.2	CFX26.2.E	22 - 26	30	109
CFX16.2	CFX16.2.E	14 - 16	20	78	CFX30.2	CFX30.2.E	26 - 30	34	117
CFX18.2	CFX18.2.E	16 - 18	22	82	CFX34.2	CFX34.2.E	30 - 34	38	125
CFX20.2	CFX20.2.E	18 - 20	24	86					

*Material stainless steel: 1.4301



Triple clamp housing, incl. top/bottom saddle clamps and stacker saddle clamp

Part No.	Part No.	ø	B ^{±2}	H	Part No.	Part No.	ø	B ^{±2}	H
Steel	Stainless steel*	[mm]	[mm]	[mm]	Steel	Stainless steel*	[mm]	[mm]	[mm]
CFX12.3	-	06 - 12	16	100	CFX18.3	-	16 - 18	22	108
CFX14.3	-	12 - 14	18	96	CFX20.3	-	18 - 20	24	114
CFX16.3	-	14 - 16	20	102	CFX22.3	-	20 - 22	26	120

*Material stainless steel: 1.4301

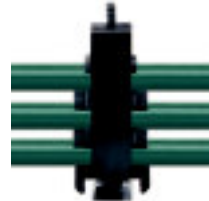

Bottom saddle clamps, single part to slide in the clamp housing

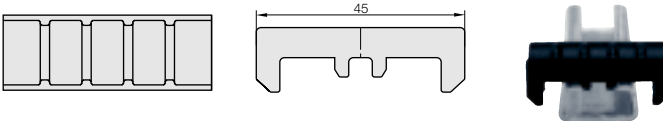

Single Parts

Stacker saddle clamps, single part for all double- and triple clamps

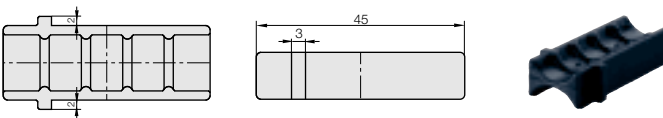

Part No. bottom saddle clamps	Part No. stacker saddle clamps	ø [mm]	Part No. bottom saddle clamps	Part No. stacker saddle clamps	ø [mm]
CG12	CD12	06 - 12	CG26	CD26	22 - 26
CG14	CD14	12 - 14	CG30	CD30	26 - 30
CG16	CD16	14 - 16	CG34	CD34	30 - 34
CG18	CD18	16 - 18	CG38	-	34 - 38
CG20	CD20	18 - 20	CG42	-	38 - 42
CG22	CD22	20 - 22			



Ribbed strain relief saddle clamps withstands increased pull forces for long-term durability

Strain relief

Phone +49- (0) 22 03-96 49-800
Fax +49- (0) 22 03-96 49-222



Multi-Clamps

The proven Chainfix-clamps now even more versatily: New parts offer numberless solutions to assemble.

- New universal strain relief
- Save assembly time and space
- Compact and modular
- For small outer diameters
- Cost-effective

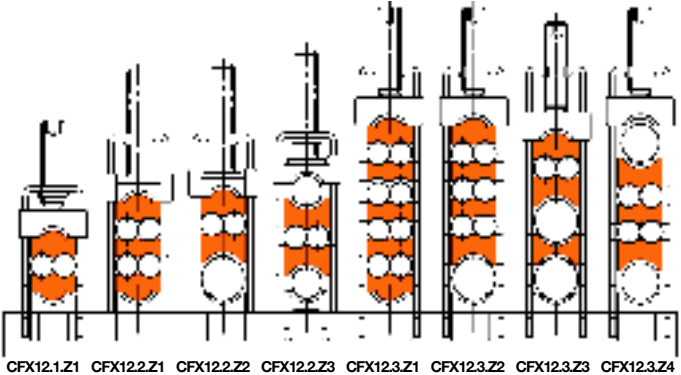
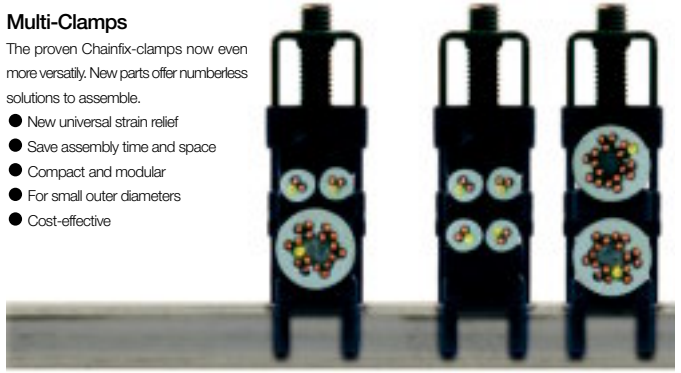

CFX12.1.Z1 CFX12.2.Z1 CFX12.2.Z2 CFX12.2.Z3 CFX12.3.Z1 CFX12.3.Z2 CFX12.3.Z3 CFX12.3.Z4

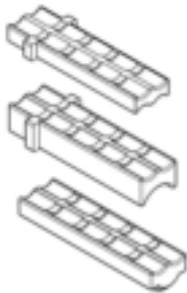

New universal saddle clamps

Part No. Version	Part No. trays as single parts				For cables Ø max. [mm]
	CDA.4/4-8	CD.4/4	CD.4/4-8	CD.12	
CFX12.1.Z1	X (2-piece)	-	-	-	6
CFX12.2.Z1	X (2-piece)	X (1-piece)	-	-	6
CFX12.2.Z2	X (1-piece)	-	X (1-piece)	-	6 + 12
CFX12.2.Z3	-	-	X (2-piece)	-	6 + 8
CFX12.3.Z1	X (2-piece)	X (3-piece)	-	-	6
CFX12.3.Z2	X (1-piece)	X (2-piece)	X (1-piece)	-	6 + 12
CFX12.3.Z3	X (1-piece)	-	X (1-piece)	X (1-piece)	6 + 12
CFX12.3.Z4	-	X (1-piece)	X (2-piece)	-	6 + 10

For stainless-steel version please insert index **[E]** Part No. CFX.12.3.Z1.E

Standard material steel zinc-coated

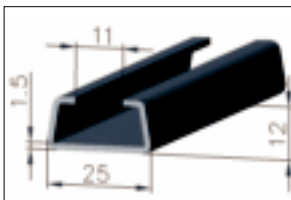

C-profile for clamps and KMA-mounting brackets

Stainless steel C-profile for all clamps, also for assembly in the KMA connection element Series E4.32, 280, 2828, E4.42, 380, 3838, E4.56, 400, 4040, 14040, 14240, E4.80, 5050, 15050 Part No. CF92.42. [XX] (XX - specify length in mm). For stainless-steel version please insert **[E]** Part No. CF92.42. [XX] [E] - Standard material steel zinc-coated.

Tolerance of C-profile lengths -5 mm possible

We have tested three different strain relief types

- ❶ Standard, hot-dipped galvanized steel strain relief clamp with single and double impact-resistant polymer saddle clamp elements (Part No. CF14.1.Z, standard elements)
- ❷ Standard strain relief housings (as used in ❶) with igumid G clamp saddles (Part No. CFY14.1)
- ❸ igus® Chainfix strain relief elements (Part No. CFX14.1)

Results: Strain relief element ❶ saddle clamps loosen at 1.000 N of pull force. The resulting diagonal position of the saddle clamp distorts the screw. Strain relief element ❷ saddle clamps loosen at 1.750 N of pull force. The improved igumid G saddle clamps attempt to hold the cable, causing the outer jacket to "peel." Strain relief element ❸ (igus® Chainfix system) saddle clamps loosen and slant 5° at 1.750 N. At 2.500 N of pull force, the cable jacket bunches up behind the clamp and, at 3.500 N of pull force, the clamps loosen completely and the cable becomes inoperative.

Conclusion: The tensile strength of the "Chainfix" line of strain relief elements developed by igus® is more than three times higher than the tensile strength of standard strain relief elements.

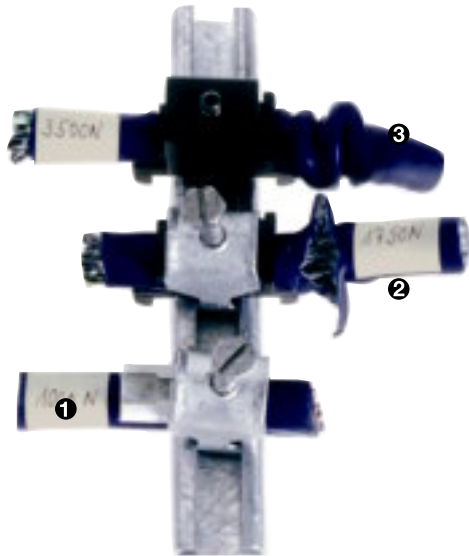

Strain relief

Phone +49- (0) 22 03-96 49-800
 Fax +49- (0) 22 03-96 49-222

Tensile strength test example with cable Ø 10,5 mm

- Tiewrap plate 2070ZB with a cable tiewrap
 Result: Tensile strength 290 N
- Chainfix clip CFC-12-M
 Result: Tensile strength 350 N



Pull force test for igus® tiewrap plates with cable tiewraps

Results: Two tiewraps are more stable than one tiewrap. If one cable tiewrap is used, the breaking force is (approx.) 350 N. If the cable is secured with two cable tiewraps, the breaking force increases to 830 N, i.e. pull force resistance more than doubles when using two cable tiewraps.

Technical data:

- Tiewrap plates: 2100.ZB/3100.ZB
- Cable: CF1.07.12
- Cable tiewrap: CFB.001





For Series:

Easy Chain®

- E200/Z200

System E2/000

- 1400/1500/1450/1480
- 2400/2500/2450/2480
- 255

System E2 E-Tubes

- R117/R118
- R48

System E4.1

- E4.28

System E4/00

- 220 (2050.Z)

System E6

- E6.29/R6.29
- E6.35
- E6.40



For Series:

Easy Chain®

- E26/Z26
- E300/Z300

System E2/000

- 2600/2700/2650/2680
- 3400/3500/3450/3480

System E4.1

- E4.32/H4.32/R4.32
- E4.42/H4.42/R4.42
- E4.56/H4.56/R4.56
- E4.80/H4.80/R4.80

- 1640

- 800 ● 840

System E4/00

- 280/290/R770
- 380/390/R780
- 400/410/R880
- 600/601/R608
- 640

System E4/4

- 2828/2928/R7728
- 3838/3938/R7828
- 4040/4140/R8840
- 5050/5150/R9850

System E4/light

- 14040/14140/R18840
- 14240/14340
- 15050/15150/R19850

System E6

- E6.52/R6.52
- E6.62
- E6.80L / E6.80

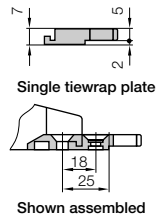
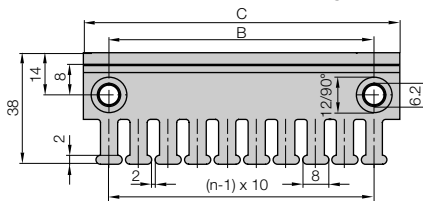
Option 1: Chainfix tiewrap plates as single parts**Characteristic features:** ● As individual component screwed on KMA (plastic metal mounting brackets)● Can be plugged in the mounting brackets ● **Use:** single part for the manufacturing of switchgear cabinets or for the assembly of machines ● Accessory for igus® E-ChainSystems®**Series 2000 - Tiewrap plate as single part**

Tiewrap plate	n Number of teeth	Dim. C [mm]	Dim. B [mm]	Center bore (- = no / + = yes)
2020.ZB	3	30	15	-
2030.ZB	4	40	20	-
2040.ZB	5	50	30	-
2050.ZB	6	60	40	-
2070.ZB	8	80	60	-
2090.ZB (= 2030.ZB + 2040.ZB)	9	90	-	-
2100.ZB	10	100	80	-
2125.ZB (= 2050.ZB + 2050.ZB)	12	120	-	-

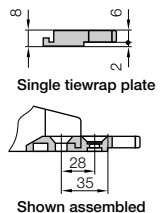
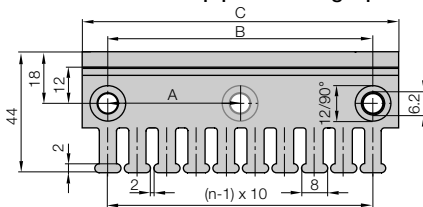
Series 3000 - Tiewrap plate as single part

Tiewrap plate	n Number of teeth	Dim. A [mm]	Dim. C [mm]	Dim. B [mm]	Center bore (- = no / + = yes)
3050.ZB	5	-	50	30	-
3075.ZB	7	-	75	55	-
3100.ZB	10	-	100	80	-
3115.ZB	11	-	115	95	-
3125.ZB	12	-	125	105	-
3150.ZB	15	-	150	130	-
3175.ZB	17	-	175	155	-
3200.ZB	20	90	200	180	+
3225.ZB	22	102,5	225	205	+
3250.ZB	25	115	250	230	+

Cable tiewraps as single part

Cable tiewraps (100-piece bag)	Width x length [mm]	Maximum Ø [mm]	Pull force resistance
CFB.001	4,8 x 150	36	222N

Option 2: Tiewrap plates with clip-on connection for the C-profile

Characteristic features: ● Can be plugged into the KMA C-profile ● Easy solvable with screwdriver
 ● Easy to assemble without any screws. Easy solvable with screwdriver nevertheless safe stop ● **Use:** single part for the manufacturing of switchgear cabinets or for the assembly of machines ● Accessory for igus® E-ChainSystems® ● For all E-Chains® with KMA and integrated C-profile



For Series:

Tiewrap plates for C-profile
 For all mounting brackets with C-Profil-option!

Part No.	Width [mm]	Number of teeth
3050.ZC	50	5
3075.ZC	75	7



Strain relief

Option 3: Clip-on tiewrap plates for opening or fixed crossbars

Characteristic features: ● Can be plugged on the fixed crossbars ● In case of many harnessed cables with strain relief "over two floors" ● If the KMA is too small for the C-profile ● Easy to assemble without any screws ● **Use:** single part for the manufacturing of switchgear cabinets or for the assembly of machines ● Accessory for igus® E-ChainSystems®



For Series:

For more details see table!

Part No.	Width [mm]	Number of teeth	For Series
fixed crossbar			
2050.Z	60	6	E/Z200, 2400/2500, 2600/2700
3050.Z	50	5	3400/3500
3075.Z	74	7	3400/3500
Part No.	Width [mm]	Number of teeth	For Series
opening crossbar			
2050.Z	60	6	E4/H4/R4.28, 220, 2650
3035.ZS	35	3	3400/3450/3500
3050.ZS	50	5	3400/3450/3500
3075.ZS	75	7	3400/3450/3500
3850.ZS	48	5	E4/H4/R4.32, E4/H4/R4.42, 280/290/R770, 380/390/R780, 2828/2928/R7728, 3838/3938/R7838, 14240/14340, E6.52, E6.62
4550.ZS	48	5	E4/H4/R4.56, E4/H4/R4.80, 400/410/R880, 4040/4140/R8840, 5050/5150/R9850, 14040/14140/R18840, 15050/15150/R19850, E6.80L, E6.80
4575.ZS	74	7	E4/H4/R4.56, E4/H4/R4.80, 400/410/R880, 4040/4140/R8840, 5050/5150/R9850, 14040/14140/R18840, 15050/15150/R19850, E6.80L, E6.80



Phone +49- (0) 22 03-96 49-800
 Fax +49- (0) 22 03-96 49-222



Option 4: integrated strain relief for E2 Tubes - Series R

Characteristic features: ● Strain relief disappears completely in the E-Tube ● Easy to assemble without any screws ● **Use:** single part for the manufacturing of switchgear cabinets or for the assembly of machines ● Accessory for igus® E-ChainSystems®



For Series:

System E2 E-Tubes

● R58 ● R68

Part No.	Width of strain relief [mm]	Number of teeth	Series
3050.Z	50	5	R68
3075.Z	75	7	R68
5850.Z	46	4	R58





For Series:

Chainfix Clip for C-profile:

For all KMA mounting brackets with C-profile-option!



Clip for C-profile

Part No. CFC-XX-C

Clips for crossbars E4.1

● E4.56/H4.56/R4.56

● E4.80/H4.80/R4.80

● 1640

● 840

Clips for crossbars E4/00

● 400/410

● 640

Clips for crossbars E4/4

● 4040/4140

● 5050/5150

Clips for crossbars E4/light

● 14040/14140

● 15050/15150

Clips for crossbars E6

● E6.80L ● E6.80



Clip for crossbars

Part No. CFC-XX-B

Chainfix clip - Modular snap-on for the C-profile

Available for all igus® E-ChainSystems with C-profiles. **Characteristic features:** ● Series of clamps and bottom parts made of plastic for cable diameters ranging from 4 mm to 24 mm ● Quick assembly without any tools ● 2 and 3 layers on top of one another possible ● Each layer can be detached and changed later on ● High tensile forces in case of single-layer installation, decreasing with the number of layers

ø Conduit [mm]	Part No. clamps	Part No. bottom part	Dim. A [mm]	Dim. B [mm]	Dim. C [mm]
04 - 08 mm	CFC-08-M	CFC-08-C	13,0	14,5	30
08 - 12 mm	CFC-12-M	CFC-12-C	24,0	23,7	36
12 - 16 mm	CFC-16-M	CFC-16-C	32,1	32,4	42
16 - 20 mm	CFC-20-M	CFC-20-C	39,1	43,2	45
20 - 24 mm	CFC-24-M	CFC-24-C	50,0	54,0	50

Modular snap-on for crossbars

Available for all igus® E-ChainSystems with crossbar serie Part No. 450.XX. **Characteristic features:** Series of clamps and bottom parts made of plastic for cable diameters ranging from 8 mm to 12 mm ● Quick assembly without any tools ● 2 and 3 layers on top of one another possible ● Each layer can be detached and changed later on ● High tensile forces in case of single-layer installation, decreasing with the number of layers

ø Conduit [mm]	Part No. clamps	Part No. crossbars	Dim. A [mm]	Dim. B [mm]	Dim. C [mm]
08 - 12 mm	CFC-12-M	CFC-12-B	24,0	23,7	36

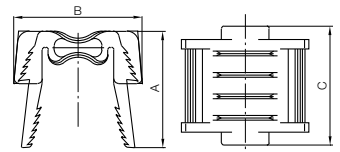
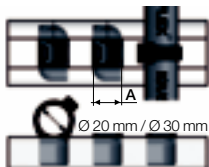
Phone +49- (0) 22 03-96 49-800
Fax +49- (0) 22 03-96 49-222igus® GmbH
51147 CologneInternet: www.igus.eu
E-mail: info@igus.de**Chainfix nugget - for top hat rail and C-profile**

● **Option 1:** completely simple and universal cable fixation, for diameter with Ø 20 mm and Ø 30 mm
● **Option 2:** Fastening through clipping onto standard top hat rail ● **Characteristic features:** ● The smart helper for electricians in the machine building industry ● Accessory for all KMA with integrated C-profile ● Strain relief for top hat rail ● Easy to assemble, without any screws and tools ● Adjustable to every E-Chain® filling ● Very small space requirement ● Easy strain relief due to fixation with pre-harnessed cable strap

For fixation	Part No. Nugget	ø Conduit max. [mm]	Dim. A [mm]
C-Profile 92.42.../92.42...E	CFN.20	20	10,8
C-Profile 92.52.../92.52...E	CFN.30.52	30	16,8
Top hat rail 35	CFN.20.N35	20	20,0

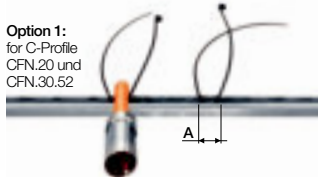
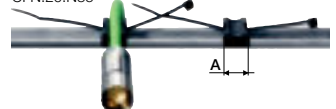
Option 1:
for C-Profile
CFN.20 und
CFN.30.52**Option 2:**
for top hat rail
CFN.20.N35

Strain relief separator - Separator with integrated strain relief

Characteristic features: ● For the use in the first or last chain link ● **Use:** single part for the manufacturing of switchgear cabinets or for the assembly of machines ● **Accessory for igus® E-ChainSystems®** ● Easy to assemble without any screws ● The number *n* is depending on the selection of cable (diameter, type) and available space

For Series	Part No. Strain relief separator	Number of teeth	Dim. A [mm]	Dim. B [mm]	Dim. C min. distance le/r [mm]	Dim. D max. cable Ø [mm]
2400/2500	▶ 2020.Z	2	10	4	-	6
2450/2480	▶ 2020.ZR	2	10	4	-	6
2600/2700	▶ 262.Z	3	10	4	-	6
3400/3500	▶ 301.Z	3	18	4	-	14
3450/3800	▶ 34501.Z	3	14	4	-	10
R157/R158	▶ 1585.01.Z	3	22	4	-	18
R167/R168	▶ 1685.01.Z	4	22	4	-	18
R48	▶ 481.ZR	2	10	3,5	10	6,5
210	▶ T2103.Z	2	8	4	13	4
E4.21	▶ T2103.Z	2	8	4	13	4
E6.29/T3.29	▶ E6.29.02.Z	2	8	4	12	4
E6.35	▶ E6.35.02.Z	3	8	4	12	4
E6.40	▶ E6.40.02.Z	3	13	4	-	8

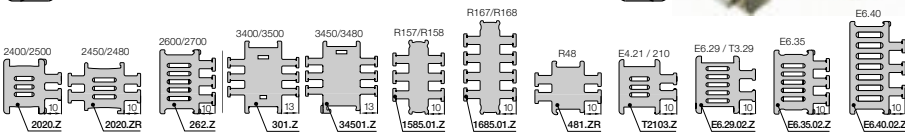
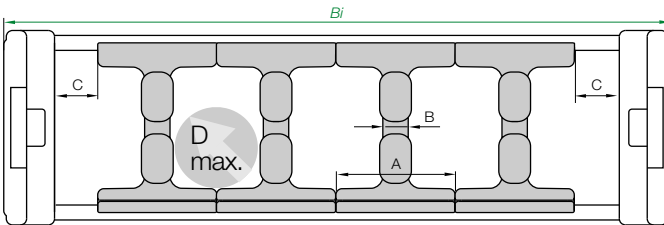

For Series:

- System E2/000**
 - 2400/2500/2450/2480
 - 2600/2700
 - 3400/3500/3450/3480
- System E2 E-Tubes**
 - R157/R158
 - R167/R168
 - R48
- System E4.1**
 - E4.21
- System E4/00**
 - 210
- System E6 / T3**
 - E6.29 / T3.29
 - E6.35
 - E6.40

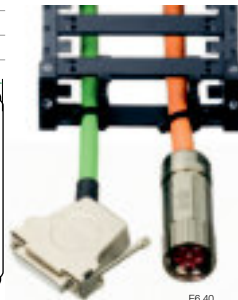

Strain relief

Phone +49- (0) 22 03-96 49-800
Fax +49- (0) 22 03-96 49-222

igus® strain relief block for small hoses and cables

● Modular system for great adaptability ● No hose damage ● Easy installation - pressing the hose into the locating notch provides reliable fastening without hardware ● Hoses and cables can be installed together in the same E-Chain® ● Accommodation of hose diameters from 4,3 to 14 mm
The modules accommodate hoses from 4,3 to 14 mm, 3 x 4,3 mm hoses can be fitted on top of each in module CFS 4,3 and 2 hoses can be fitted directly on top of each other in one notch using module CFS 6. The modules have a width of 27,5 mm, are inserted into the base plate and then fastened in position with M4 countersunk-head screws. The exception is module CFS 55,9 which offers the capacity for 5 x 9 mm hoses with twice the width. The base plate and cover plate are available in widths ranging from 75 to 240 mm. The height of the spacers and modules is 16 mm. Several layers can be installed directly above one another.



- 1 Cover plate
 - 2 Spacers
 - 3 Base plate
 - 4 Grid-dimensioned modules
- W = 27,5 mm, H = 16 mm

Part No. Blocks	Hose Ø [mm]	Number of hoses	Width [mm]
CFS 4,3	4,3	4 - 12	27,5
CFS 6	6,0	3 - 6	27,5
CFS 9	9,0	2	27,5
CFS 55,9	9,0	5	55,0
CFS 10	10,0	2	27,5
CFS 14	14,0	1	27,5

Part No. Base plate	Part No. Cover plate	Width [mm]
CFSU	CFSP	75,0
CFSU	CFSP	102,5
CFSU	CFSP	130,0
CFSU	CFSP	185,0
CFSU	CFSP	212,0
CFSU	CFSP	240,0

Part No. Spacer	Height [mm]
CFSD	16,0
CFSD	12,0



The image features a close-up, low-angle view of several blue corrugated pipes. The pipes are arranged in a way that creates a strong sense of depth and perspective, with the lines of the corrugations converging towards the top right. The lighting is dramatic, highlighting the texture of the pipes against a dark, almost black background. The overall composition is clean and industrial.

PMA

PMAFLEX | Conduits | Cable protection



Product	Description	Page
PMA conduits		
PACO	Flexible, medium, divisible	11.4
TN	Divisible connectors, PG	11.4
GTN	Divisible lock nuts, PG	11.4
PCL	Very flexible, medium	11.5
VOH	Pliable, very heavy	11.5
PIS/PIH	Highly flexible, medium	11.6
CYL	Very flexible, medium	11.7

PMAFIX | Connectors | Safety and sealing systems



Product	Description	Page
PMA connectors		
IP66 - stat., IP54 dyn.	Universal safety clip	11.8
IP68 - stat., IP67 dyn.	Oval clip	11.8
PMAFIX / PMAFLEX	Connectors	11.9
PMAFIX connectors VW	90° elbow, metric & PG	11.10
PMAFIX connectors VN	Straight, metric & PG	11.11
PMAFIX connectors VA	45° elbow, metric & PG	11.12
PMAFIX connectors VB	90° curved elbow, metric & PG	11.13
PMAFIX connectors VO	Flange 90°	11.13

PMA | Accessories



Product	Description	Page
PMA accessories		
PMAFIX FH0	One-piece system support	11.14
PMA MN	Hexagonal Lock Nuts, metric & PG	11.14
PMA SGB	Tube clamps	11.15
PMA 514	Plug Screws, metric & PG	11.15

PMA - corrugated conduits, connectors, system support, accessories

- Wide range of tubes
- Long service life of the tubes especially through millions of reverse bending cycles (I-PIST)
- UL-approved products
- PMAFIX safety locking system



PMA-Program - Wide selection of tubes and systems

The PMA cable protection system is applied wherever the mechanical protection of electrical wires and cables is required. Very flexible types of conduits are especially suitable for the additional protection of leads in E-ChainSystems® if required. By combining technical excellence with rigorous international safety standards, PMA meets the demands of industry worldwide - specialising in applications from the machine building industries to high tech manufacturing; heavy plant and vehicle construction; fiber optics, solar energy and robotic applications with high speed and millions of reversed bending cycles.

PMAFLEX - Conduits

PMAFLEX covers different conduit types for a variety of applications in cable protection. The PMAFLEX range offers conduits for technically demanding applications and special requirements. Conduit sizes range from 4.5 mm to 125 mm diameters, from lightweight to heavyweight, and pliable to highly flexible. Standard colours are black and grey. Many conduits are specially approved, e.g. CSA, UL Recognition, NF, SNCF, DB, etc.

PMAFI - Connectors

The designation PMAFIX describes a very large range of connectors for PMA conduits with the patented PMA safety clip system. Connectors are available for ingress protection IP66 and IP68. IP66 connectors are fitted with a preinstalled universal safety clip which ensures a quick "push-in" installation. IP68 connectors for increased requirements will be delivered with a special conduit seal cap.



PMAFLEX Conduits PACO - flexible, medium, divisible

The PMA COFLEX conduit type PACO has been created for **retrofit and pre-loomed applications**. New cables can be added without the need for re-wiring or re-threading within the **building of machines and installations**. Further, this product will be used increasingly in **vehicle manufacturing and building construction**. Divisible connectors and locknuts are available for this product group. **Features:** ● Specially modified polyamide 6, good closure up to IP50 ● Self-extinguishing, free of halogen and cadmium ● Temperature range: -40 °C to 100 °C; **Short-term** to 130 °C ● **Chemical resistance:** To fuels, mineral oils, fats, alkalies, weak acids and bases etc.

Part No. structure

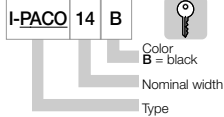

! I-PACO - is suitable
■ for static use only!

Part No.	Conduit size NW	Inside Ø d1 [mm]	Outside Ø d2 [mm]	stat.** R [mm]	PU [m]
I-PACO-10B	10	8.9	13.6	55	50
I-PACO-14B	14	12.9	18.7	75	50
I-PACO-20B	20	19.8	25.9	105	50
I-PACO-23B	23	23.7	31.3	125	50
I-PACO-37B	37	31.7	41.9	170	25
I-PACO-45B	45	43.1	54.2	180	25
I-PACO-70B	70	66.0	79.8	300	10

TN - Divisible connectors, PG

These divisible connectors are suitable for repairs or where cable protection systems are installed **after wiring** has taken place in the **machine building and installation industry**. Further, these products will be used increasingly in the **vehicle building and building construction**. **Features:** ● Specially formulated polyamide ● IP50, self-extinguishing, free of halogen, phosphor and cadmium ● Very good impact strength ● Temperature range: -30 °C to 100 °C; **Short-term** 130 °C

Part No.	Thread PG	Fits to conduit COFLEX NW	Inside Ø d1 [mm]	Wrench-Size	Dimensions length [mm]
I-BTNO-P0910	9	10	9.0	19.0	28.0
I-BTNO-P1314	13.5	14	13.0	24.0	35.0
I-BTNO-P2120	21	20	20.0	32.0	34.0
I-BTNO-P2923	29	23	31.0	41.0	42.0
I-BTNO-P2937	29	37	31.0	50.0	50.0

GTN - Divisible lock nuts, PG

These divisible lock nuts are used in connection with the connectors **TN** for repairs or where cable protection systems are **installed after wiring** has taken place in the machine building and **installation industry**. Further, these products will be used increasingly in the **vehicle building and building construction**. **Features:** ● Specially formulated polyamide ● Self-extinguishing, free of halogen, phosphor and cadmium ● Very good impact strength ● Temperature range: -30 °C to 100 °C; **Short-term** 130 °C

Part No.	Thread PG	Fits to COFLEX Connector	Wrench-Size	Dimensions height [mm]
I-BGTN-0910	9	I-BTNO-P0910	22.0	11.0
I-BGTN-1314	13.5	I-BTNO-P1314	30.0	14.0
I-BGTN-2120	21	I-BTNO-P2120	36.0	14.0
I-BGTN-2923	29	I-BTNO-P2923	46.0	17.0
I-BGTN-2937	29	I-BTNO-P2937	55.0	17.0

PMAFLEX Conduits PC - very flexible, medium

The PMAFLEX conduit type PCL is suitable for a wide range of applications in general machine building. Further more, this conduit type can be used in the vehicle building industry. The product is characterised by good weather resistance and applicability at low temperatures. **Features:** ● Specially modified polyamide 6/6.6 for cold impact ● Self-extinguishing ● Free of halogen and cadmium ● High impact strength also at low temperatures ● **Temperature range:** -50 °C to 105 °C; **Short-term** to 150 °C ● **Chemical resistance:** To fuels, mineral oils, fats, alkalies, weak acids and bases etc.

Part No. black	Part No. grey	Conduit size NW	Conduit size metric	Inside Ø d1 [mm]	Outside Ø d2 [mm]	stat.** R [mm]	PU [m]
I-PCLT-07B	I-PCLT-07S	7	10	6.2	10.0	15	50
I-PCLT-10B	I-PCLT-10S	10	12	9.6	13.0	20	50
I-PCLT-12B	I-PCLT-12S	12	16	12.0	15.8	30	50
I-PCLT-17B	I-PCLT-17S	17	20	16.2	21.2	40	50
I-PCLT-23B	I-PCLT-23S	23	25	22.6	28.5	45	50
I-PCLT-29B	I-PCLT-29S	29	32	29.0	34.5	55	50
I-PCLT-36B	I-PCLT-36S	36	40	36.5	42.5	60	30
I-PCLT-48B	I-PCLT-48S	48	50	47.5	54.5	70	30
I-PCLG-17B	I-PCLG-17S	17	20	15.3	21.2	40	50
I-PCLG-23B	I-PCLG-23S	23	25	21.9	28.5	45	50
I-PCLG-29B	I-PCLG-29S	29	32	27.6	34.5	55	50
I-PCLG-36B	I-PCLG-36S	36	40	36.0	42.5	60	30
I-PCLG-48B	I-PCLG-48S	48	50	47.0	54.5	70	30
I-PCLG-56B	I-PCLG-56S	56	68	56.3	67.2	130	30
I-PCLG-70B	I-PCLG-70S	70	80	67.5	80.0	160	30
I-PCLG-95B	I-PCLG-95S	95	106	91.5	106.0	210	30
I-PCLG-125B	I-PCLG-125S	125	146	126.5	146.5	450	6



Part No. structure

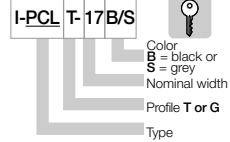

I-PCLT/PCLG - is recommended for static use!

(moderate dynamic application possible)

PMA-Program

Phone +49- (0) 22 03-96 49-800
Fax +49- (0) 22 03-96 49-222

PMAFLEX Conduits VOH - pliable, very heavy

The robust construction of PMAFLEX VOH conduit lends it **outstanding impact and pull-out resistance**. In the US market, this conduit type can also be used for exterior applications in machinery and installations (from 17 mm inside diameter). This product offers the greatest possible mechanical protection with good flammability properties. **Features:** ● Specially modified polyamide 6 ● Very good self-extinguishing properties ● Free of halogen and cadmium ● High impact strength and pull-out resistance ● High stiffness and compression strength ● **Temperature range:** -40 °C to 105 °C; **Short-term** to 150 °C ● **Chemical resistance:** To fuels, mineral oils, fats, alkalies, weak acids and bases etc.

Part No. black	Part No. grey	Conduit size NW	Conduit size metric	Inside Ø d1 [mm]	Outside Ø d2 [mm]	stat.** R [mm]	PU [m]
I-VOHD-07B	I-VOHD-07S	7	10	5.8	10.0	20	100
I-VOHD-10B	I-VOHD-10S	10	12	9.0	13.0	25	50
I-VOHD-12B	I-VOHD-12S	12	16	11.6	15.8	30	50
I-VOHG-17B	I-VOHG-17S	17	20	14.5	21.0	40	50
I-VOHG-23B	I-VOHG-23S	23	25	21.1	28.5	50	50
I-VOHG-29B	I-VOHG-29S	29	32	26.6	34.5	60	50
I-VOHG-36B	I-VOHG-36S	36	40	35.0	42.5	70	30
I-VOHG-48B	I-VOHG-48S	48	50	46.5	54.5	80	30
I-VOHG-56B	I-VOHG-56S	56	68	55.5	67.2	135	10
I-VOHG-70B	I-VOHG-70S	70	80	67.0	80.0	200	10
I-VOHG-95B	I-VOHG-95S	95	106	90.5	106.0	300	10
I-VOHG-125B	I-VOHG-125S	125	146	126.0	146.5	480	6



Part No. structure

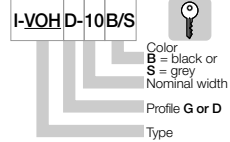

I-VOHD/VOHG - is suitable for static use only!

igus® GmbH
51147 Cologne

Internet: www.igus.eu
E-mail: info@igus.de

Fine profile T - tight bending radius

Coarse profile G - high pull-out strength

** *stat. R* = lowest recommended bending radius for static (fixed) installation

*** *dyn. R* = lowest recommended bending radius for dynamic (flexible) installation

PMAFLEX Conduits PIS/PIH - highly flexible, medium

These **highly flexible products** are used primarily in **automation** applications and for **connections subject to intense movements** in general machinery construction. Their outstanding material properties make these conduits especially suitable for outdoor applications where they are exposed to **intensive sunlight (UV)**.

Features: ● Specially modified polyamide 12 ● **PIS:** medium-wall (nominal width 07 to 48) - **PIH:** heavy-wall (nominal width 56 to 125) ● Self-extinguishing ● Free of halogen and cadmium ● Good mechanical properties also at low temperatures ● **Temperature range:** -50 °C to 95 °C; **Short-term** to 150 °C ● **Chemical resistance:** To fuels, mineral oils, fats, alkalies, acids and bases etc.

Part No. structure

I-PIS T-48B/S



Color
B = black or
S = grey
 Nominal width
 Profile T or G
 Type

Part No. black	Part No. grey	Conduit size NW	Conduit size metric	Inside Ø d1 [mm]	Outside Ø d2 [mm]	stat.**/dyn.** R [mm]	PU [m]
I-PIST-07B	I-PIST-07S	7	10	6.2	10.0	15 / 40	50
I-PIST-10B	I-PIST-10S	10	12	9.6	13.0	20 / 50	50
I-PIST-12B	I-PIST-12S	12	16	11.9	15.8	25 / 65	50
I-PIST-17B	I-PIST-17S	17	20	16.4	21.1	30 / 65	50
I-PIST-23B	I-PIST-23S	23	25	22.6	28.4	35 / 90	50
I-PIST-29B	I-PIST-29S	29	32	29.0	34.3	45 / 110	50
I-PIST-36B	I-PIST-36S	36	40	36.5	42.5	60 / 165	30
I-PIST-48B	I-PIST-48S	48	50	47.5	54.5	70 / 180	30
I-PISG-17B	-	17	20	15.2	21.1	30 / 80	50
I-PISG-23B	I-PISG-23S	23	25	21.7	28.4	40 / 100	50
I-PISG-29B	I-PISG-29S	29	32	27.4	34.3	50 / 120	50
I-PISG-36B	I-PISG-36S	36	40	35.8	42.3	60 / 180	30
I-PISG-48B	I-PISG-48S	48	50	46.7	54.2	70 / 200	30
I-PIHG-56B	I-PIHG-56S	56	68	56.3	67.2	110 / 270	30
I-PIHG-70B	I-PIHG-70S	70	80	67.2	79.6	150 / 350	30
I-PIHG-95B	I-PIHG-95S	95	106	91.3	106.0	170 / 450	30
I-PIHG-125B	I-PIHG-125S	125	146	126.5	146.5	350 / 580	20

I-PIS/PIH is recommended for highly flexible application

 Phone +49- (0) 22 03-96 49-800
 Fax +49- (0) 22 03-96 49-222

 igus® GmbH
 51147 Cologne

 Internet: www.igus.eu
 E-mail: info@igus.de

Fine profile T -
tight bending radius

Coarse profile G -
high pull-out strength

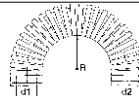

** **stat. R** = lowest recommended bending radius for static (fixed) installation

*** **dyn. R** = lowest recommended bending radius for dynamic (flexible) installation

PMAFLEX Conduits CYL - very flexible, medium

PMA CYL ECONOMY conduit exhibits **very good flexibility** and is also suitable for low-temperature applications. These conduits are used primarily in construction of machinery and equipment. **Features:**

- Specially modified polyamide 6/6.6 for cold impact
- Self-extinguishing, free of halogen and cadmium
- Good impact strength also at low temperatures
- **Temperature range:** -40 °C to 105 °C; **Short-term** to 150 °C
- **Chemical resistance:** To fuels, mineral oils, fats, alkalies, weak acids and bases etc.



Part No. black	Part No. grey	Conduit size NW	Conduit size metric	Inside Ø d1 [mm]	Outside Ø d2 [mm]	stat.** R [mm]	PU [m]
I-CYLT-07B	I-CYLT-07S	7	10	6.2	10.0	15	50
I-CYLT-10B	I-CYLT-10S	10	12	9.6	13.0	20	50
I-CYLT-12B	I-CYLT-12S	12	16	12.0	15.8	30	50
I-CYLT-17B	I-CYLT-17S	17	20	16.2	21.2	40	50
I-CYLT-23B	I-CYLT-23S	23	25	22.6	28.5	40	50
I-CYLT-29B	I-CYLT-29S	29	32	29.0	34.5	50	50
I-CYLT-36B	I-CYLT-36S	36	40	36.5	42.5	60	30
I-CYLT-48B	I-CYLT-48S	48	50	47.5	54.5	70	30
I-CYLG-23B	I-CYLG-23S	23	25	21.9	28.5	45	50
I-CYLG-29B	I-CYLG-29S	29	32	27.6	34.5	55	50
I-CYLG-36B	I-CYLG-36S	36	40	36.0	42.5	60	30
I-CYLG-48B	I-CYLG-48S	48	50	47.0	54.5	70	30
I-CYLG-56B	-	56	68	56.3	67.2	120	30
I-CYLG-70B	-	70	80	68.0	80.0	160	30
I-CYLG-95B	-	95	106	91.9	106.0	210	10
I-CYLG-125B	-	125	146	126.5	146.5	450	6

Part No. structure

I-CYL T-29B/S

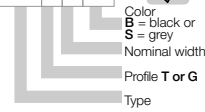

I-CYLT/CYLG - is recommended for static use!

(moderate dynamic application possible)

PMA-Program

Phone +49- (0) 22 03-96 49-800
Fax +49- (0) 22 03-96 49-222

igus® GmbH
51147 Cologne

Internet: www.igus.eu
E-mail: info@igus.de

Fine profile T - tight bending radius

Coarse profile G - high pull-out strength

-R

** **stat. R** = lowest recommended bending radius for static (fixed) installation

*** **dyn. R** = lowest recommended bending radius for dynamic (flexible) installation

IP66 - static, IP54 dynamic - universal safety clip

- One piece Fitting, sealing by cone
- Easy "push-in" installation
- Pre-installed safety clip AFN2
- Fits any type of conduit profile (T and G)
- Excellent pull-out strength
- Re-opening for safety reasons only possible with a screwdriver
- Clip pre-installed in all IP66 connectors

Installation

1 Push in conduit with a slight twist (open using screwdriver on conduit side)



2 Pull back slightly to ensure the locking mechanism is fully engaged

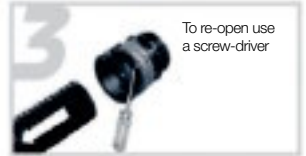

3 To re-open use a screw-driver

IP68 - static, IP67 dynamic - oval clip

- High sealing through additional seal cap
- For highest dynamic applications
- Fits any type of conduit profile (T and G)
- Excellent pull-out strength
- Re-opening for safety reasons only possible with a screwdriver

Installation

1 A Conduit, B Seal cap, C Connector, D Oval clip, E flat gasket (or O-ring seal)



2 Push seal cap onto end of conduit to achieve IP68



3 For ease of installation moisten seal cap with water or grease



4 Push conduit with seal cap fully into connector. This guarantees PMA's unique IP68/67 rating*



5 Install retaining oval clip



6 To re-open use a screwdriver

* For safety reasons, oval clip will not fit if seal cap is not fully installed.
 Ensure to follow O-ring manufacturers guidelines when using O-rings for sealing purposes.

PMAFIX - Connectors

The designation **PMAFIX** describes a very large range of connectors for PMA conduits with the patented PMA safety clip system. Connectors are available for ingress protection IP66 and IP68. IP66 connectors are fitted with a preinstalled universal safety clip which ensures a quick "push-in" installation. IP68 connectors for increased requirements will be delivered with a special conduit seal cap.

Table 1 - PMAFIX / PMAFLEX conduit code

Nominal width	UK sizes	PMA code
7	10	M
10	12	0
12	16	2
17	20	7
23	25	3
29	32	9
36	40	6
48	50	8

Table 2 - Thread codes

Thread metric	PMA code
M12 x 1.5	M12
M16 x 1.5	M16
M20 x 1.5	M20
M25 x 1.5	M25
M32 x 1.5	M32
M40 x 1.5	M40
M50 x 1.5	M50
M63 x 1.5	M63

Thread PG	PMA code
PG07	P07
PG09	P09
PG11	P11
PG13.5	P13
PG16	P16
PG21	P21
PG29	P29
PG36	P36
PG42	P42
PG48	P48

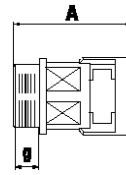

g = Thread length
A = Overall length

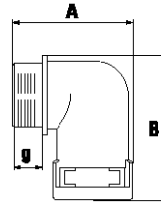

g = Thread length
A x B = External dimensions

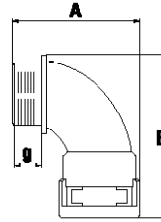

g = Thread length
A x B = External dimensions

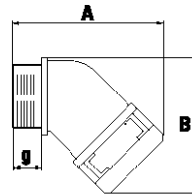

g = Thread length
A x B = External dimensions

PMA-Program

Phone +49- (0) 22 03-96 49-800
Fax +49- (0) 22 03-96 49-222

igus® GmbH
51147 Cologne

Internet: www.igus.eu
E-mail: info@igus.de

PMAFIX Connectors VW - 90° elbow, metric & PG

These PMAFIX connectors are used in a **wide range of applications**. Together with PMAFLEX conduits they offer the highest grade of safety and sealing. **Features:** ● High-grade formulated polyamide ● Self-extinguishing, free of halogen, phosphor and cadmium ● Excellent impact strength ● **Temperature range:** -40 °C to 105 °C; **Short-term** to 160 °C ● **Content of delivery IP66:** Fitting with pre-assembled universal safety clips (AFN2), **IP68:** Fitting with oval clips (OVN2), conduit and thread seal (NVN3, SVN4)

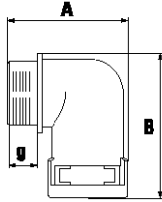

g = Thread length
A x B = External dimensions

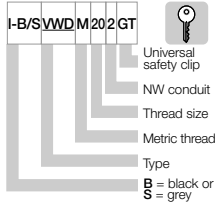
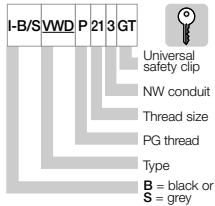
Part No. structure metric

Part No. structure PG

Part No. IP66	Part No. IP68	Thread metric	Fits to conduit size:		Thread length [mm]	External dim. [mm]
			NW	metric		
I-□ VWD-M12MGT	I-□ VVW-M12M	M12 x 1.5	7	10	11.0	32.0 x 35.0
I-□ VWD-M120GT	I-□ VVW-M120	M12 x 1.5	10	12	11.0	34.0 x 39.5
I-□ VWD-M160GT	I-□ VVW-M160	M16 x 1.5	10	12	11.0	34.0 x 40.5
I-□ VWD-M162GT	I-□ VVW-M162	M16 x 1.5	12	16	11.0	38.5 x 46.0
I-□ VWD-M202GT	I-□ VVW-M202	M20 x 1.5	12	16	11.0	38.5 x 47.5
I-□ VWD-M207GT	I-□ VVW-M207	M20 x 1.5	17	20	11.0	43.5 x 58.5
I-□ VWD-M253GT	I-□ VVW-M253	M25 x 1.5	23	25	12.0	54.0 x 65.0
I-□ VWD-M329GT	I-□ VVW-M329	M32 x 1.5	29	32	15.0	64.5 x 73.0
I-□ VWD-M406GT	I-□ VVW-M406	M40 x 1.5	36	40	19.0	78.0 x 96.0
I-□ VWD-M508GT	I-□ VVW-M508	M50 x 1.5	48	50	19.0	91.5 x 106.0

Part No. IP66	Part No. IP68	Thread PG	Fits to conduit size:		Thread length [mm]	External dim. [mm]
			NW	metric		
I-□ VWD-P07MGT-11	I-□ VVW-P07M	7	7	10	11.0	32.0 x 35.0
I-□ VWD-P070GT-11	I-□ VVW-P070	7	10	12	11.0	34.0 x 39.5
I-□ VWD-P09MGT-11	-	9	7	10	11.0	32.0 x 36.5
I-□ VWD-P090GT-11	I-□ VVW-P090	9	10	12	11.0	34.0 x 39.5
I-□ VWD-P092GT-11	I-□ VVW-P092	9	12	16	11.0	38.5 x 44.5
I-□ VWD-P11MGT-11	-	11	7	10	11.0	32.0 x 38.0
I-□ VWD-P110GT-11	I-□ VVW-P110	11	10	12	11.0	34.0 x 41.0
I-□ VWD-P112GT-11	I-□ VVW-P112	11	12	16	11.0	38.5 x 46.0
I-□ VWD-P13MGT-11	-	13.5	7	10	11.0	32.0 x 39.5
I-□ VWD-P130GT-11	I-□ VVW-P130	13.5	10	12	11.0	34.0 x 42.5
I-□ VWD-P132GT-11	I-□ VVW-P132	13.5	12	16	11.0	38.5 x 47.5
I-□ VWD-P137GT-11	I-□ VVW-P137	13.5	17	20	11.0	43.5 x 58.5
I-□ VWD-P167GT-11	I-□ VVW-P167	16	17	20	11.0	43.5 x 58.5
I-□ VWD-P213GT	I-□ VVW-P213	21	23	25	11.0	54.0 x 67.0
I-□ VWD-P299GT	I-□ VVW-P299	29	29	32	12.0	61.5 x 74.5
I-□ VWD-P366GT	I-□ VVW-P366	36	36	40	13.0	72.0 x 98.0
I-□ VWD-P488GT	I-□ VVW-P488	48	48	50	13.0	85.5 x 111.0

□ = Replace with "B" to order black or "S" to order grey

For the sizes NW 17 to NW 48 curved elbows of type VB are available

PMAFIX Connectors VN - straight, metric & PG

These PMAFIX connectors are used in a **wide range of applications**. Together with PMAFLEX conduits they offer the highest grade of safety and sealing. **Features:** ● High-grade formulated polyamide ● Self-extinguishing, free of halogen, phosphor and cadmium ● Excellent impact strength ● **Temperature range:** -40 °C to 105 °C; **Short-term** to 160 °C ● **Content of delivery IP66:** Fitting with pre-assembled universal safety clips (AFN2), **IP68:** Fitting with oval clips (OVN2), conduit and thread seal (NVN3, SVN4)



Part No. IP66	Part No. IP68	Thread metric	Fits to conduit size:		Thread length [mm]	Overall length [mm]
			NW	metric		
I-□ VND-M12MGT	I-□ VNV-M12M	M12 x 1.5	7	10	11.0	34.5
I-□ VND-M120GT	I-□ VNV-M120	M12 x 1.5	10	12	11.0	36.5
I-□ VND-M160GT	I-□ VNV-M160	M16 x 1.5	10	12	11.0	36.5
I-□ VND-M162GT	I-□ VNV-M162	M16 x 1.5	12	16	11.0	39.5
I-□ VND-M202GT	I-□ VNV-M202	M20 x 1.5	12	16	11.0	39.5
I-□ VND-M207GT	I-□ VNV-M207	M20 x 1.5	17	20	11.0	47.5
I-□ VND-M257GT	I-□ VNV-M257	M25 x 1.5	17	20	12.0	48.5
I-□ VND-M253GT	I-□ VNV-M253	M25 x 1.5	23	25	12.0	52.0
I-□ VND-M323GT	I-□ VNV-M323	M32 x 1.5	23	25	15.0	55.5
I-□ VND-M329GT	I-□ VNV-M329	M32 x 1.5	29	32	15.0	56.0
I-□ VND-M409GT	I-□ VNV-M409	M40 x 1.5	29	32	19.0	60.0
I-□ VND-M406GT	I-□ VNV-M406	M40 x 1.5	36	40	19.0	72.5
I-□ VND-M506GT	I-□ VNV-M506	M50 x 1.5	36	40	19.0	72.0
I-□ VND-M508GT	I-□ VNV-M508	M50 x 1.5	48	50	19.0	72.5
I-□ VND-M638GT	I-□ VNV-M638	M63 x 1.5	48	50	19.0	72.0

Part No. IP66	Part No. IP68	Thread PG	Fits to conduit size:		Thread length [mm]	Overall length [mm]
			NW	metric		
I-□ VND-P07MGT-11	I-□ VNV-P07M	7	7	10	11.0	34.5
I-□ VND-P070GT-11	I-□ VNV-P070	7	10	12	11.0	36.5
I-□ VND-P072GT-11	-	7	12	16	11.0	39.0
I-□ VND-P09MGT-11	I-□ VNV-P09M	9	7	10	11.0	34.5
I-□ VND-P090GT-11	I-□ VNV-P090	9	10	12	11.0	36.5
I-□ VND-P092GT-11	I-□ VNV-P092	9	12	16	11.0	39.0
I-□ VND-P097GT-11	I-□ VNV-P097	9	17	20	11.0	47.5
I-□ VND-P11MGT-11	I-□ VNV-P11M	11	7	10	11.0	34.5
I-□ VND-P110GT-11	I-□ VNV-P110	11	10	12	11.0	36.5
I-□ VND-P112GT-11	I-□ VNV-P112	11	12	16	11.0	39.0
I-□ VND-P117GT-11	I-□ VNV-P117	11	17	20	11.0	47.5
I-□ VND-P13MGT-11	-	13.5	7	10	11.0	34.5
I-□ VND-P130GT-11	I-□ VNV-P130	13.5	10	12	11.0	36.5
I-□ VND-P132GT-11	I-□ VNV-P132	13.5	12	16	11.0	39.0
I-□ VND-P137GT-11	I-□ VNV-P137	13.5	17	20	11.0	47.5
I-□ VND-P160GT-11	-	16	10	12	11.0	36.5
I-□ VND-P162GT-11	I-□ VNV-P162	16	12	16	11.0	39.0
I-□ VND-P167GT-11	I-□ VNV-P167	16	17	20	11.0	47.5
I-□ VND-P163GT-11	I-□ VNV-P163	16	23	25	11.0	51.0
I-□ VND-P213GT	I-□ VNV-P213	21	23	25	12.0	52.0
I-□ VND-P299GT	I-□ VNV-P299	29	29	32	12.0	53.0
I-□ VND-P296GT	I-□ VNV-P296	29	36	40	12.0	67.5
I-□ VND-P366GT	I-□ VNV-P366	36	36	40	13.0	66.0
I-□ VND-P368GT	-	36	48	50	13.0	68.5
I-□ VND-P428GT	I-□ VNV-P428	42	48	50	13.0	68.5
I-□ VND-P488GT	I-□ VNV-P488	48	48	50	13.0	66.5

□ = Replace with "B" to order black or "S" to order grey

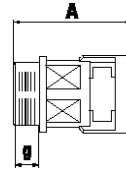

g = Thread length
A = Overall length

Part No. structure metric

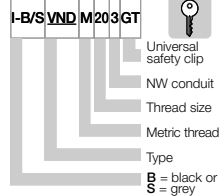

Part No. structure PG

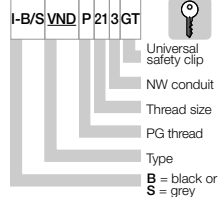

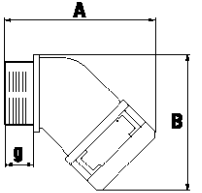

g = Thread length
A x B = External dimensions

Part No. structure metric

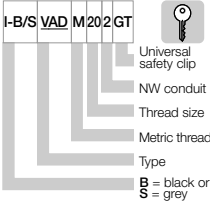

Part No. structure PG

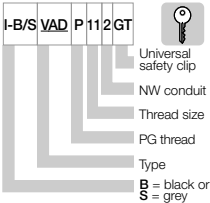

PMAFIX Connectors VA - 45° elbow, metric & PG

These PMAFIX connectors are used in a wide range of applications. Together with PMAFLEX conduits they offer the highest grade of safety and sealing. **Features:** ● High-grade formulated polyamide, thread made of nickel-plated brass ● Self-extinguishing, free of halogen, phosphor and cadmium ● Excellent impact strength ● **Temperature range:** -40 °C to 105 °C; **Short-term** to 160 °C ● **Content of delivery IP66:** Fitting with pre-assembled universal safety clips (AFN2), **IP68:** Fitting with oval clips (OVN2), conduit and thread seals (NVN3, SVN4)

Part No. IP66	Part No. IP68	Thread metric	Fits to conduit size:		Thread length [mm]	External dim. [mm]
			NW	metric		
I-□VAD-M120GT	-	M12 x 1.5	10	12	11.0	43.5 x 37.0
I-□VAD-M160GT	I-□VAV-M160	M16 x 1.5	10	12	11.0	43.5 x 38.0
I-□VAD-M162GT	I-□VAV-M162	M16 x 1.5	12	16	11.0	48.0 x 40.0
I-□VAD-M202GT	I-□VAV-M202	M20 x 1.5	12	16	11.0	48.0 x 41.5
I-□VAD-M207GT	I-□VAV-M207	M20 x 1.5	17	20	11.0	55.5 x 51.5
I-□VAD-M253GT	I-□VAV-M253	M25 x 1.5	23	25	12.0	65.0 x 58.5
I-□VAD-M329GT	I-□VAV-M329	M32 x 1.5	29	32	15.0	73.5 x 66.5
I-□VAD-M406GT	I-□VAV-M406	M40 x 1.5	36	40	19.0	92.5 x 85.5
I-□VAD-M506GT	I-□VAV-M506	M50 x 1.5	36	40	19.0	100.0 x 89.5
I-□VAD-M508GT	I-□VAV-M508	M50 x 1.5	48	50	19.0	100.0 x 96.0
I-□VAD-M638GT	I-□VAV-M638	M63 x 1.5	48	50	19.0	100.0 x 104.0

Part No. IP66	Part No. IP68	Thread PG	Fits to conduit size:		Thread length [mm]	External dim. [mm]
			NW	metric		
I-□VAD-P090GT	I-□VAV-P090	9	10	12	11.0	43.5 x 37.0
I-□VAD-P112GT	I-□VAV-P112	11	12	16	11.0	48.0 x 40.0
I-□VAD-P132GT	I-□VAV-P132	13.5	12	16	11.0	48.0 x 41.5
I-□VAD-P137GT	I-□VAV-P137	13.5	17	20	11.0	55.0 x 50.0
I-□VAD-P167GT	I-□VAV-P167	16	17	20	11.0	55.0 x 51.5
I-□VAD-P213GT	I-□VAV-P213	21	23	25	12.0	67.0 x 59.0
I-□VAD-P299GT	I-□VAV-P299	29	29	32	12.0	69.0 x 67.0
I-□VAD-P366GT	I-□VAV-P366	36	36	40	13.0	86.0 x 86.0
I-□VAD-P488GT	I-□VAV-P488	48	48	50	13.0	93.0 x 99.0

□ = Replace with "B" to order black or "S" to order grey

PMAFIX Connectors VB - 90° curved elbow, metric & PG

These PMAFIX connectors are used in a wide range of applications. Together with PMAFLEX conduits they offer the highest grade of safety and sealing. **Features:** ● High-grade formulated polyamide ● Self-extinguishing, free of halogen, phosphor and cadmium ● Excellent impact strength ● **Temperature range:** -40 °C to 105 °C; **Short-term** to 160 °C ● **IP66:** Fitting with pre-assembled universal safety clips (AFN2) ● **IP68:** Fitting with oval clips (OVN2), conduit and thread seal (NVN3,SVN4)



Part No. IP66	Part No. IP68	Thread metric	Fits to conduit size:		Thread length [mm]	External dim. [mm]
			NW	metric		
I-□VBD-M207GT	I-□VBV-M207	M20 x 1.5	17	20	11.0	47.5 x 73.0
I-□VBD-M257GT	I-□VBV-M257	M25 x 1.5	17	20	12.0	48.5 x 76.0
I-□VBD-M253GT	I-□VBV-M253	M25 x 1.5	23	25	12.0	57.5 x 83.0
I-□VBD-M323GT	I-□VBV-M323	M32 x 1.5	23	25	15.0	61.0 x 87.5
I-□VBD-M329GT	I-□VBV-M329	M32 x 1.5	29	32	15.0	70.5 x 93.0
I-□VBD-M409GT	I-□VBV-M409	M40 x 1.5	29	32	19.0	74.5 x 98.5
I-□VBD-M406GT	I-□VBV-M406	M40 x 1.5	36	40	19.0	85.0 x 121.0
I-□VBD-M506GT	I-□VBV-M506	M50 x 1.5	36	40	19.0	85.0 x 125.0
I-□VBD-M508GT	I-□VBV-M508	M50 x 1.5	48	50	19.0	98.5 x 138.0
I-□VBD-M638GT	I-□VBV-M638	M63 x 1.5	48	50	19.0	98.5 x 138.0

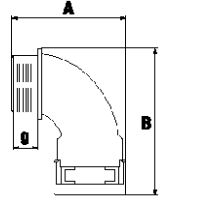

g = Thread length
A x B = External dimensions

Part No. IP66	Part No. IP68	Thread PG	Fits to conduit size:		Thread length [mm]	External dim. [mm]
			NW	metric		
I-□VBD-P167GT	I-□VBV-P167	16	17	20	11.0	47.4 x 73.0
I-□VBD-P213GT	I-□VBV-P213	21	23	25	12.0	57.5 x 85.0
I-□VBD-P299GT	I-□VBV-P299	29	29	32	12.0	67.5 x 96.0
I-□VBD-P366GT	I-□VBV-P366	36	36	40	13.0	79.0 x 123.0
I-□VBD-P488GT	I-□VBV-P488	48	48	50	13.0	92.5 x 135.0

Part No. structure metric

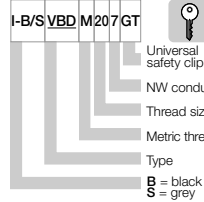

Part No. structure PG

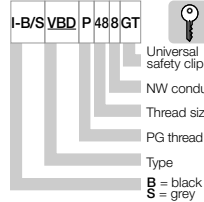

□ = Replace with "B" to order black or "S" to order grey. For smaller conduit sizes NW 07 to NW 12 appropriate standard elbows of type VW are available

PMAFIX Connectors VO - flange 90°

These PMAFIX connectors are used in a wide range of applications. Together with PMAFLEX conduits they offer the highest grade of safety and sealing. **Features:** ● IP66: Fitting with pre-assembled universal safety clips (AFN2), flange seal (OR) ● IP68: Fitting with oval clips (OVN2), conduit and flange seal (NVN3, OR)

Part No. IP66	Part No. IP68	Fits to conduit size:		Dimensions width x length x depth	Fixing screws
		NW	metric		
I-□VOD-P167GT	I-□VOV-P167	17	20	45.0 x 66.0 x 34.0	2 x M5
I-□VOD-P213GT	I-□VOV-P213	23	25	63.0 x 70.0 x 42.0	2 x M6
I-□VOD-P299GT	I-□VOV-P299	29	32	67.0 x 78.0 x 48.0	4 x M6
I-□VOD-P366GT	I-□VOV-P366	36	40	85.0 x 102.0 x 64.0	4 x M6
I-□VOD-P488GT	I-□VOV-P488	48	50	86.0 x 119.0 x 76.0	4 x M6

□ = Replace with "B" to order black or "S" to order grey

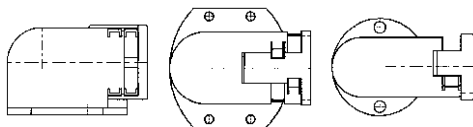

Part No. structure PG

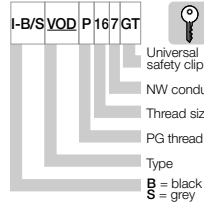



PMAFIX FH-0 - one-piece system supports

The **one-piece PMACLIP** system support is designed for fixation of **PMAFLEX** conduits. This product can be used in all **machine and installation applications** for easy assembly of the PMA system.

Features: ● High-grade formulated polyamide ● Self-extinguishing, free of halogen, phosphor and cadmium ● Excellent impact strength ● **Temperature range:** -40 °C to 105 °C; **Short-term** 160 °C

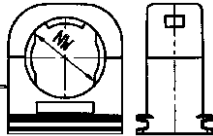
Part No. black	Part No. grey	Fits to conduit size:		Dimensions width x length x depth	Fixing screw
		NW	metric		
I-BFH-07-0	I-SFH-07-0	7	10	17.0 x 21.5 x 20.0	1 x M4
I-BFH-10-0	I-SFH-10-0	10	12	20.5 x 24.5 x 20.0	1 x M5
I-BFH-12-0	I-SFH-12-0	12	16	24.0 x 27.0 x 20.0	1 x M5
I-BFH-17-0	I-SFH-17-0	17	20	30.0 x 34.0 x 20.0	1 x M6
I-BFH-23-0	I-SFH-23-0	23	25	38.5 x 42.0 x 20.0	1 x M6
I-BFH-29-0	I-SFH-29-0	29	32	45.5 x 48.0 x 20.0	1 x M6
I-BFH-36-0	I-SFH-36-0	36	40	55.5 x 56.0 x 20.0	1 x M6
I-BFH-48-0	I-SFH-48-0	48	50	67.5 x 68.0 x 20.0	1 x M6



PMA MN - hexagonal lock nuts, metric & PG

These hexagonal lock nuts are suitable for a wide range of applications. High torque guarantees a safe connection of the system. **Features:** ● Polyamide glass fiber reinforced ● **Temperature range:** -40 °C to 105 °C; **Short-term** 150 °C

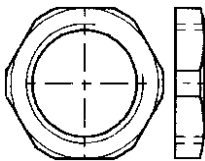

Part No. black	Part No. grey	Fits to thread: metric	Wrench size	Dimensions
				height
I-BMN-M12	I-GMN-M12	M12 x 1.5	17.0	5.0
I-BMN-M16	I-GMN-M16	M16 x 1.5	22.0	5.0
I-BMN-M20	I-GMN-M20	M20 x 1.5	27.0	6.0
I-BMN-M25	I-GMN-M25	M25 x 1.5	32.0	6.0
I-BMN-M32	I-GMN-M32	M32 x 1.5	41.0	7.0
I-BMN-M40	I-GMN-M40	M40 x 1.5	50.0	7.0
I-BMN-M50	I-GMN-M50	M50 x 1.5	60.0	8.0
I-BMN-M63	I-GMN-M63	M63 x 1.5	75.0	8.0

Part No. black	Part No. grey	Fits to thread: PG	Wrench size	Dimensions
				height
I-BMN-07	I-GMN-07	7	19.0	5.0
I-BMN-09	I-GMN-09	9	22.0	5.0
I-BMN-11	I-GMN-11	11	24.0	5.0
I-BMN-13	I-GMN-13	13.5	27.0	6.0
I-BMN-16	I-GMN-16	16	30.0	6.0
I-BMN-21	I-GMN-21	21	36.0	7.0
I-BMN-29	I-GMN-29	29	46.0	7.0
I-BMN-36	I-GMN-36	36	60.0	8.0
I-BMN-48	I-GMN-48	48	70.0	8.0



PMA SGB - tube clamps

These tube clamps are used for the mounting and smooth connection to the PMA conduits in the general machine and installation constructions. They are especially suitable for the mounting of static conduits.

Features: ● Galvanized steel according to DIN 3016 ● Elastomer free of halogen ● **Temperature range:** -50 °C bis 105 °C



Part No.	Fits to conduit size	Fits to conduit size	Dimensions	Fixing screw
	NW	metric	width [mm]	
I-SGB-07	7	10	13.0	1 x M4
I-SGB-09	10	12	13.0	1 x M4
I-SGB-11	12	16	13.0	1 x M4
I-SGB-16	17	20	16.0	1 x M5
I-SGB-21	23	25	16.0	1 x M5
I-SGB-29	29	32	19.0	1 x M6
I-SGB-36	36	40	19.0	1 x M6
I-SGB-48	48	50	19.0	1 x M6

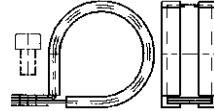

PMA 514 - plug screws, metric & PG

These plug screws are suitable for an accurate termination where no thread holes in casing and distribution boxes are needed. **Features:** ● Product with metric thread: **PA-GF** - Product with PG thread: **PS**

● Free of halogen, phosphor and cadmium ● IP54 ● **Temperature range:** -20 °C to 60 °C; **Short-term** 100 °C



Part No.	Fits to thread	Outside	Total length	Thread length
	metric	Ø [mm]	[mm]	[mm]
I-514-M12	M12 x 1.5	15.0	8.0	6.0
I-514-M16	M16 x 1.5	20.0	9.0	6.0
I-514-M20	M20 x 1.5	24.0	9.5	6.0
I-514-M25	M25 x 1.5	30.0	11.5	8.0
I-514-M32	M32 x 1.5	37.0	12.0	8.0
I-514-M40	M40 x 1.5	46.0	13.0	8.0
I-514-M50	M50 x 1.5	56.0	15.0	10.0
I-514-M63	M63 x 1.5	70.0	17.0	12.0

Part No.	Fits to thread	Outside	Total length	Thread length
	PG	Ø [mm]	[mm]	[mm]
I-514-07	7	15.0	8.0	6.0
I-514-09	9	19.0	9.5	6.5
I-514-11	11	22.0	10.0	6.5
I-514-13	13.5	25.0	10.0	6.5
I-514-16	16	27.0	10.0	6.5
I-514-21	21	33.0	12.0	8.0
I-514-29	29	44.0	11.5	8.0
I-514-36	36	55.0	14.0	10.0
I-514-48	48	69.0	16.0	12.0

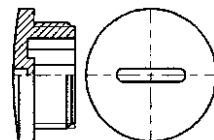

Standard Corrugated Conduits

Products		PCL PA6	CYL PA6	VOH PA6	PIS PA12	FH
Tube size:		Very flexible, medium wall	Very flexible, medium wall	Flexible, very heavy	Highly flexible medium wall	PMACLIP - one-piece system support
metric	width [mm]	corrugated conduits	corrugated conduits	corrugated conduits	corrugated conduits	
10	07	PCLT-07* -	CYLT-07* -	VDHD-07* -	PIST-07* -	*FH-07-0
12	10	PCLT-10* -	CYLT-10* -	VOHD-10* -	PIST-10* -	*FH-10-0
16	12	PCLT-12* -	CYLT-12* -	VOHD-12* -	PIST-12* -	*FH-12-0
20	17	PCLT-17* PCLG-17*	CYLT-17* -	- VOHG-17*	PIST-17* PISG-17*	*FH-17-0
25	23	PCLT-23* PCLG-23*	CYLT-23* CYLG-23*	- VOHG-23*	PIST-23* PISG-23*	*FH-23-0
32	29	PCLT-29* PCLG-29*	CYLT-29* CYLG-29*	- VOHG-29*	PIST-29* PISG-29*	*FH-29-0
40	36	PCLT-36* PCLG-36*	CYLT-36* CYLG-36*	- VOHG-36*	PIST-36* PISG-36*	*FH-36-0
50	48	PCLT-48* PCLG-48*	CYLT-48* CYLG-48*	- VOHG-48*	PIST-48* PISG-48*	*FH-48-0

* = replaced by "B" for black or "S" for gray

T or D = fine profile

G = coarse profile

Standard Corrugated Conduits

Products		PCL PA6	CYL PA6	VOH PA6	PIS PA12	FH
Tube size:		Very flexible, medium wall	Very flexible, medium wall	Flexible, very heavy	Highly flexible medium wall	PMACLIP - one-piece system support
metric	width [mm]	corrugated conduits	corrugated conduits	corrugated conduits	corrugated conduits	
10	07	PCLT-07* -	CYLT-07* -	VDHD-07* -	PIST-07* -	*FH-07-0
12	10	PCLT-10* -	CYLT-10* -	VOHD-10* -	PIST-10* -	*FH-10-0
16	12	PCLT-12* -	CYLT-12* -	VOHD-12* -	PIST-12* -	*FH-12-0
20	17	PCLT-17* PCLG-17*	CYLT-17* -	- VOHG-17*	PIST-17* PISG-17*	*FH-17-0
25	23	PCLT-23* PCLG-23*	CYLT-23* CYLG-23*	- VOHG-23*	PIST-23* PISG-23*	*FH-23-0
32	29	PCLT-29* PCLG-29*	CYLT-29* CYLG-29*	- VOHG-29*	PIST-29* PISG-29*	*FH-29-0
40	36	PCLT-36* PCLG-36*	CYLT-36* CYLG-36*	- VOHG-36*	PIST-36* PISG-36*	*FH-36-0
50	48	PCLT-48* PCLG-48*	CYLT-48* CYLG-48*	- VOHG-48*	PIST-48* PISG-48*	*FH-48-0

* = replaced by "B" for black or "S" for gray

T or D = fine profile

G = coarse profile

JUMBO Corrugated Conduits PMAGRIP

Products		PCLG PA6	PIHG PA12	BGG	BGO	SGS
Tube size:		Very flexible, medium wall	Highly flexible medium wall	PMAGRIP-straight	PMAGRIP-90° angle	PMAGRIP-tube clamps
Width [mm]		corrugated conduits	corrugated conduits			
56		PCLG-56*	PIHG-56*	*GG-56	*GO-56	SGS-56
70		PCLG-70*	PIHG-70*	*GG-70	*GO-70	SGS-70
95		PCLG-95*	PIHG-95*	*GG-95	*GO-95	SGS-95
125		PCLG-125*	PIHG-125*	*GG-125	-	SGS-125

* = replaced by "B" for black or "S" for gray

T or D = fine profile

G = coarse profile

PMAFIX



Products	IP66 - VN 9A	IP66 - VA 9A	IP66 - VW 9A	IP66 - VB	IP68 - VNZ 9A	MN
Thread	PMAFIX	PMAFIX	PMAFIX	PMAFIX	Straight with	PMA
Type	straight	45° angle	90° angle	90° elbow angle	strain relief	hexagonal lock nuts
M12x1.5	*VND-M12MGT	-	*VWD-M12MGT	-	-	*MN-M12
M12x1.5	*VND-M120GT	*VAD-M120GT	*VWD-M120GT	-	-	*MN-M12
M16x1.5	*VND-M162GT	*VAD-M162GT	*VWD-M162GT	-	*VNZ-M162S	*MN-M16
M20x1.5	*VND-M207GT	*VAD-M207GT	*VWD-M207GT	*VBD-M207GT	*VNZ-M207S	*MN-M20
M25x1.5	*VND-M253GT	*VAD-M253GT	*VWD-M253GT	*VBD-M253GT	*VNZ-M253S	*MN-M25
M32x1.5	*VND-M329GT	*VAD-M329GT	*VWD-M329GT	*VBD-M329GT	*VNZ-M329S	*MN-M32
M40x1.5	*VND-M406GT	*VAD-M406GT	*VWD-M406GT	*VBD-M406GT	*VNZ-M406S	*MN-M40
M50x1.5	*VND-M508GT	*VAD-M508GT	*VWD-M508GT	*VBD-M508GT	*VNZ-M508S	*MN-M50

* = replaced by "B" for black or "S" for gray

PMAFIX



Products	IP66 - VOD 9A	IP66 - VY 9A	IP66 - FT/VT 9A	IP66 - FV 9A	SGB	
Tube size:	PMAFIX	PMAFIX	PMAFIX	PMAFIX	PMAFIX-	
metric	flange 90°	Y-distribution piece	T-distribution piece	V-distribution piece	tube clamps	
width [mm]						
10	07	-	-	-	SGB-07	
12	10	-	*VYD-10070GT	*FTD-101010GT	*FVD-10070GT	SGB-09
16	12	-	*VYD-121010GT	*FTD-121212GT	*FVD-121010GT	SGB-11
20	17	*VOD-P167GT	*VYD-171212GT	*FTD-171717GT	*FVD-171212GT	SGB-16
25	23	*VOD-P213GT	*VYD-231717GT	*FTD-232323GT	*FVD-231717GT	SGB-21
32	29	*VOD-P299GT	*VYD-292323GT	*FTD-292929GT	-	SGB-29
40	36	*VOD-P366GT	*VYD-362929GT	*FTD-363636GT	-	SGB-36
50	48	*VOD-P488GT	*VYD-483636GT	-	-	SGB-48

* = replaced by "B" for black or "S" for gray

PMAFIX - Order example

XXXX-10 07 07 XX

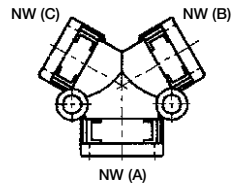
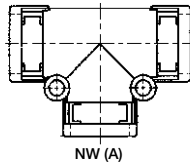
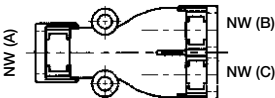

Please note: Since January 2003 are only complete packaging units available on request!

PMA-Program

Phone +49- (0) 22 03-96 49-800
Fax +49- (0) 22 03-96 49-222

igus® GmbH
51147 Cologne

Internet: www.igus.eu
E-mail: info@igus.de

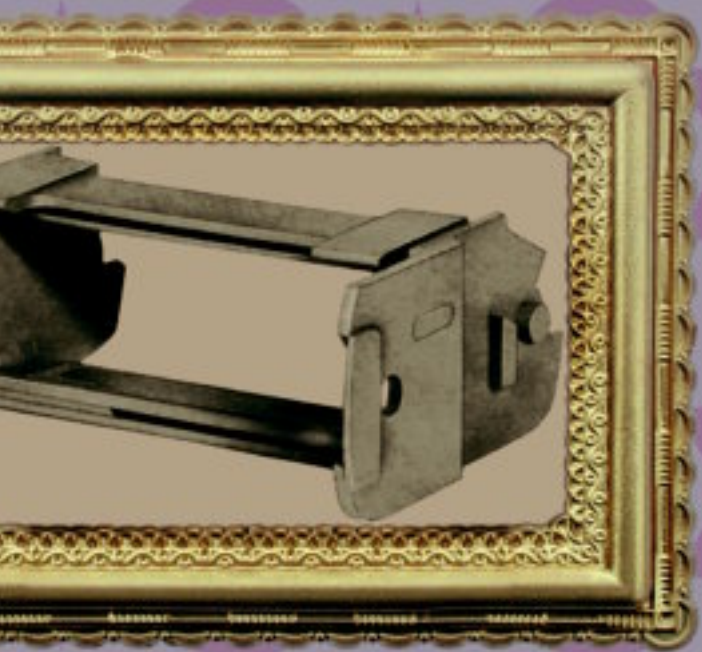

igus[®] classic & about igus[®]

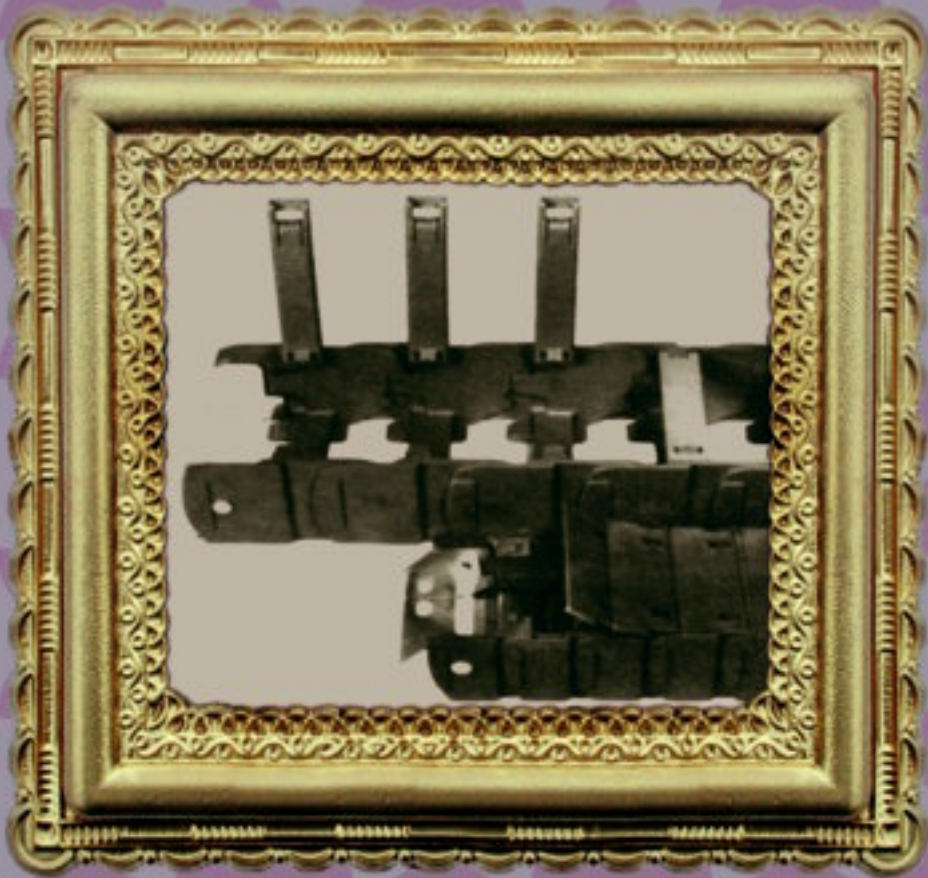

Older products are still available!

For new designs, we recommend using the newer and more advanced E-Chain® Series. The complete product range, incl. all mounting variations and guide troughs for the "Classic"-series are available on a continuous basis. Find the complete range online with the respective quicklink. Find free to download 3D-CAD files and many more useful features.

Selection table

Series		Inner height <i>hi</i> [mm]	Inner width <i>Bi</i> [mm]	Outer width <i>Ba</i> [mm]	Outer height <i>ha</i> [mm]	Bending radius <i>R</i> [mm]	Unsupported length max. [m]	Page
"Classic"-Series								
200/240/250	E2 medium	25	25 - 125	41 - 141	35	55 - 250	2,00	12.4
26/27/27	E2 medium	35	50 - 200	66 - 219	50	63 - 250	2,20	12.6
340/350	E2 medium	45	50 - 250	70 - 270	64	75 - 300	2,50	12.8
Line extensions and special solutions								
38022	E4/00	52	50 - 400	76 - 426	64	75 - 350	3,80	12.12
383822	E4/4	52	50 - 400	77 - 427	64	75 - 350	3,80	12.14
E-Band		25,5	25	36	36	45 - 200	1,50	12.18

Selection table - Classics online-program

Series	Product	Inner height <i>hi</i> [mm]	Inner width <i>Bi</i> [mm]	Outer width <i>Ba</i> [mm]	Outer height <i>ha</i> [mm]	Radius <i>R</i> [mm]	Unsupp. length max. [m]	 Web- link	New designed Series ▶ page
"Classic"-Series - online									
15 classic	Zipper	17	15 - 50	26 - 61	24	38 - 180	1,20	www.igus.de/en/15s	15 4.18
10 classic	E2 mini	18	15 - 50	26 - 61	23	28 - 180	1,20	www.igus.de/en/10s	10 5.48
B15/B15i classic	E2 mini	17	15 - 50	26 - 61	24	38 - 180	1,20	www.igus.de/en/B15s	B15 5.70
20/25	E2 medium	25	11 - 103	27 - 118	34	55 - 250	2,00	www.igus.de/en/20	2400 5.102
30/35/36	E2 medium	45	75 - 175	93 - 195	64	75 - 300	2,50	www.igus.de/en/30	3400 5.126
R58 classic	E2 E-Tubes	35	50 - 75	66 - 92	50	75 - 250	2,30	www.igus.de/en/r58s	R58 6.34
R68 classic	E2 E-Tubes	45	75 - 175	93 - 196	64	100 - 300	2,50	www.igus.de/en/r68s	R68 6.42
140/141/R188	E4/light	56	50 - 600	76 - 626	84	135 - 500	4,00	www.igus.de/en/140	14040 7.124
142/143	E4/light	62	50 - 400	76 - 426	84	135 - 500	4,00	www.igus.de/en/142	14240 7.134
150/151/R198	E4/light	80	50 - 600	80 - 630	108	150 - 500	4,50	www.igus.de/en/150	15050 7.144
22/23/R76	E4/0	28	40 - 300	60 - 320	42	55 - 250	2,10	www.igus.de/en/22	E4.28 7.24
28/29/R77	E4/0	32	50 - 400	73 - 423	54	63 - 300	2,50	www.igus.de/en/28	E4.32 7.34
38/39/R78	E4/0	42	50 - 400	77 - 427	64	75 - 350	3,25	www.igus.de/en/38	E4.42 7.48
40/41/R88	E4/0	56	50 - 600	86 - 636	84	135 - 500	4,50	www.igus.de/en/40	E4.56 7.62
50/51/R98	E4/0	80	50 - 600	100 - 650	108	150 - 1000	6,00	www.igus.de/en/50	E4.80 7.76

You miss a classic serie in this catalog? Find a detailed catalog as PDF-download online at ▶ www.igus.eu/classics

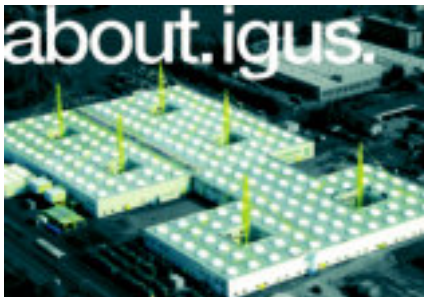

about igus® - Application examples, online-services, igus® delivery service and quality ▶ from page 12.20



Faxforms ▶ from page 12.58. Terminology index ▶ from page 12.64. igus® addresses ▶ from page 12.68

Classic-series quicklinks

Quicklinks for more information or additional functions can be found on each product page. "Visit" your selected product online by clicking on ► www.igus.de/en/240 to find more information, such as detailed interior separation and mounting options, 3-D CAD, DXF, and PDF-files for downloading, application examples, and much more; everything you need to know about your igus® product.

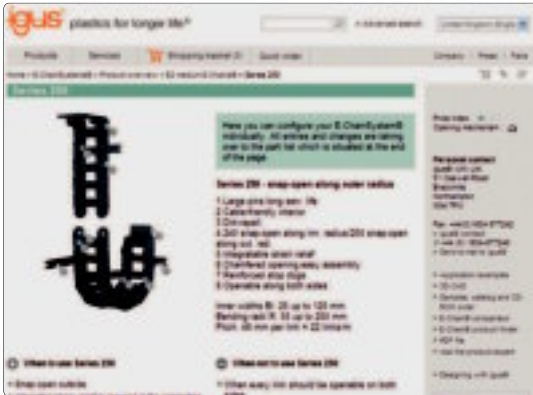

www.igus.eu/classics

Find online all information about the igus®-classics series

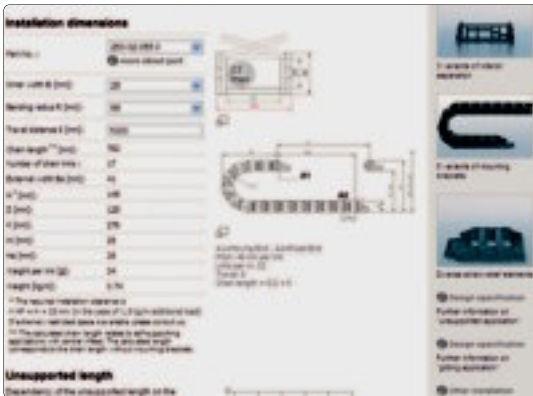

Configure your E-Chain® online. Easy takeover into the part list

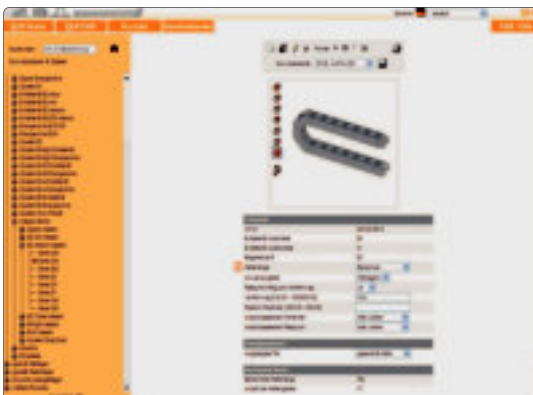

Generate quick and easy a 3D-file

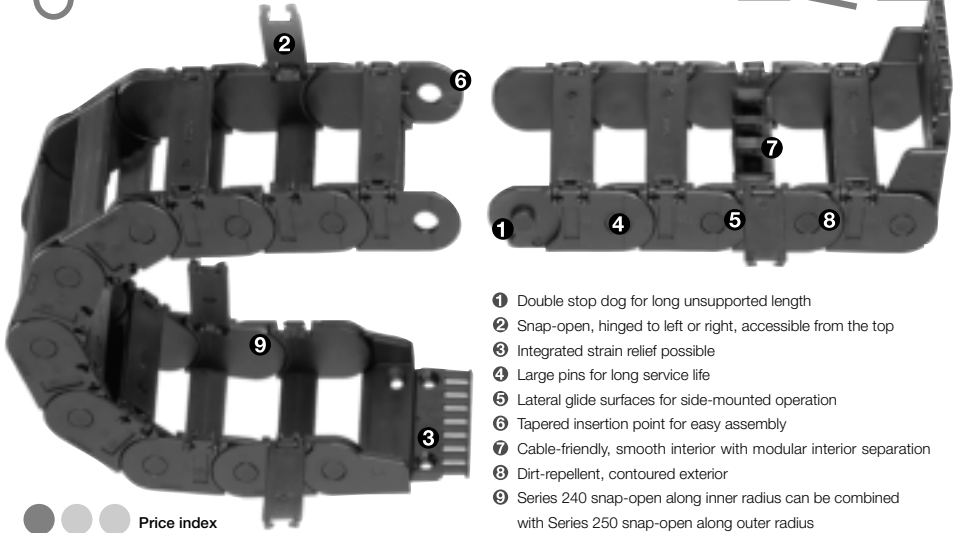

● ● ● Price index

- ❶ Double stop dog for long unsupported length
- ❷ Snap-open, hinged to left or right, accessible from the top
- ❸ Integrated strain relief possible
- ❹ Large pins for long service life
- ❺ Lateral glide surfaces for side-mounted operation
- ❻ Tapered insertion point for easy assembly
- ❼ Cable-friendly, smooth interior with modular interior separation
- ❽ Dirt-repellent, contoured exterior
- ❾ Series 240 snap-open along inner radius can be combined with Series 250 snap-open along outer radius

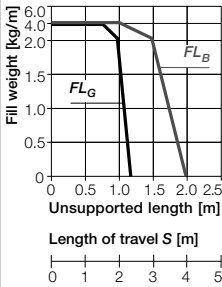

Unsupported length

FL_G = with straight upper run

FL_B = with permitted sag

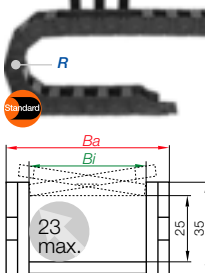
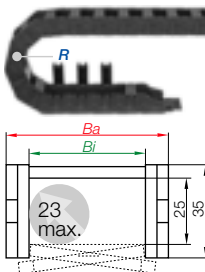
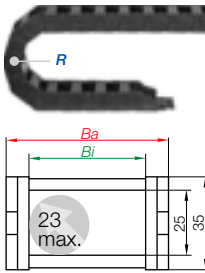
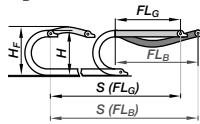

Series 200 - non snap-open

Part No.	Bi [mm]	Ba [mm]	R [mm] Bending Radii
200.02.□.0	25	41	055 075 100
200.03.□.0	38	54	125 150 175
200.05.□.0	57	73	200 225 250
200.07.□.0	77	93	
200.09.□.0	90	106	
200.10.□.0	103	119	
200.12.□.0	125	141	

Radii for all widths!

Supplement Part No. with required radius. Example: 200.10.□.100.0
Bending radii listed above can be combined with every chain width!

Series 240 - snap-open along inner radius

Part No.	Bi [mm]	Ba [mm]	R [mm] Bending Radii
240.02.□.0	25	41	055 075 100
240.03.□.0	38	54	125 150 175
240.05.□.0	57	73	200 225 250
240.07.□.0	77	93	
240.09.□.0	90	106	
240.10.□.0	103	119	
240.12.□.0	125	141	

Radii for all widths!

Supplement Part No. with required radius. Example: 240.10.□.100.0
Bending radii listed above can be combined with every chain width!

Series 250 - snap-open along outer radius

Part No.	Bi [mm]	Ba [mm]	R [mm] Bending Radii
250.02.□.0	25	41	055 075 100
250.03.□.0	38	54	125 150 175
250.05.□.0	57	73	200 225 250
250.07.□.0	77	93	
250.09.□.0	90	106	
250.10.□.0	103	119	
250.12.□.0	125	141	

Radii for all widths!

Supplement Part No. with required radius. Example: 250.10.□.100.0
Bending radii listed above can be combined with every chain width!

Part No. structure

250. 10. 100. 0

- Color black
- Bending radius
- Width
- Series

Order example 2,0 m complete E-Chain®
(indicate chain-lengths or number of links)

2,0 m (44 links) Series 250.10.100.0

+ 2 separators 211 assembled each 2nd link

+ 1 set mounting brackets + tie-wrap plates 2100.34.PZB

Pitch = 46 mm Links per m = 22 Chain length = $S/2 + K$

R	055	075	100	125	150	175	200	225	250
H ⁺⁴	145	185	235	285	335	385	435	485	535
D	125	150	170	195	220	245	270	295	320
K	276	346	414	496	578	660	742	814	920

The required clearance height is $H_F = H + 25$ mm (with 1,5 kg/m fill weight). Please consult igus® if space is particularly restricted.

Installation Dimensions

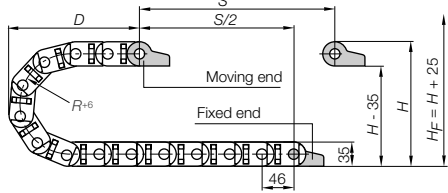

25

E2 medium classic
Inner height: 25 mm

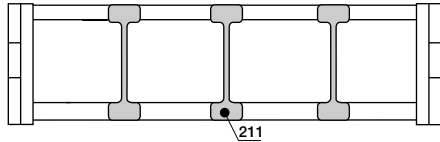

Vertical separator

unassembled	201
assembled	211

Interior Separation

Full program ▶ page 5.106



2...3.PZ(B)
Moving end

2...4.PZ(B)
Fixed end

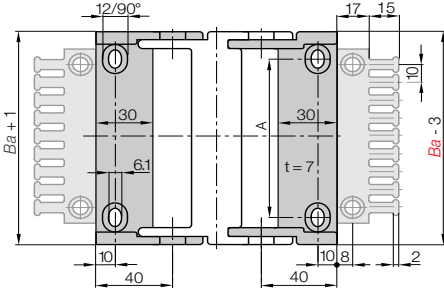

Moving end (with bore)
2...3.PZ(B)

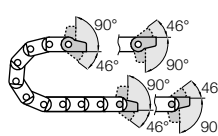

Mounting Brackets

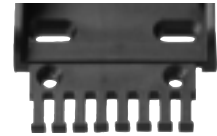

2...4.PZ(B)
Fixed end (with pin)

Polymer pivoting, with or without strain relief tiewrap plates

For E-Chain®	Part No. full set with tiewrap plate	Part No. with tiewrap plate + 10 cable tiewraps	Part No. full set without tiewrap plate	Dimension A [mm]
200/240/250.02. ▶	2020.34.PZB	2020.34.PZBK1	2020.34.PZ	12
200/240/250.03. ▶	2030.34.PZB	2030.34.PZBK1	2030.34.PZ	25
200/240/250.05. ▶	2050.34.PZB	2050.34.PZBK1	2050.34.PZ	44
200/240/250.07. ▶	2070.34.PZB	2070.34.PZBK1	2070.34.PZ	64
200/240/250.09. ▶	2090.34.PZB	2090.34.PZBK1	2090.34.PZ	77
200/240/250.10. ▶	2100.34.PZB	2100.34.PZBK1	2100.34.PZ	90
200/240/250.12. ▶	2125.34.PZB	2125.34.PZBK1	2125.34.PZ	112

Tiewrap plates are possible at the moving end and/or the fixed end!

Part No. structure

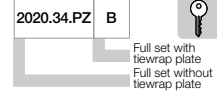

Full set, for both ends:

2020.34.PZB (+ tiewrap plates)

Single-part order:

2020.3.PZB (+ tiewrap plates)

Mounting bracket with bore

2020.4.PZB (+ tiewrap plates)

Mounting bracket with pin

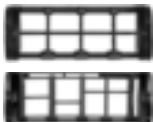

Interior separation with full-width shelves and shelves possible



Polymer mounting bracket, locking



KMA mounting bracket available with C-profile



Steel mounting bracket available

Additional Features

For more features ▶ see link below



Phone +49- (0) 22 03-96 49-800
Fax +49- (0) 22 03-96 49-222



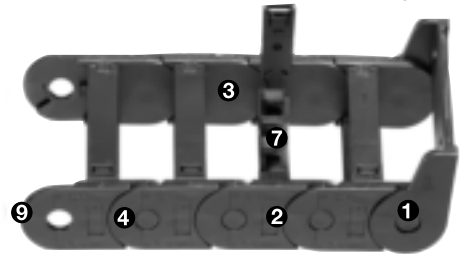

- ❶ Large pins for long service life
- ❷ Double stop dog for long unsupported length
- ❸ Space-saving ratio of inner-to-outer dimensions
- ❹ Lateral glide surfaces for side-mounted operation
- ❺ Cable-friendly, smooth interior
- ❻ Series 27i snap-open along inner radius can be combined with Series 27 snap-open along outer radius, accessible from the top
- ❼ Modular interior separation
- ❸ Integrated strain relief possible
- ❹ Side wear pads

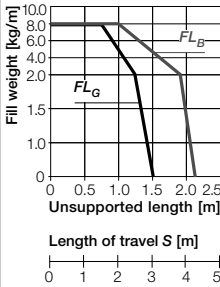

Unsupported length

FL_G = with straight upper run

FL_B = with permitted sag

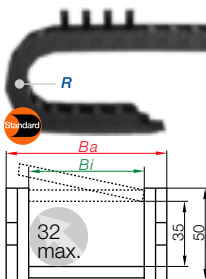
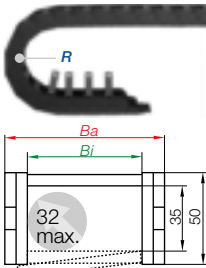
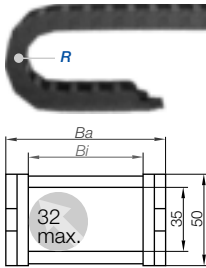
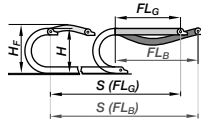

Series 26 - non snap-open

Part No.	Bj [mm]	Ba [mm]	R [mm] Bending Radii
26.05.□.0	50	66	063 075 100
26.07.□.0	75	91	125 150 175
26.10.□.0	100	116	200 250
26.12.□.0	125	141	Radii for all widths!
26.15.□.0	150	166	
26.17.□.0	175	194	
26.20.□.0	200	219	

Supplement Part No. with required radius. Example: 26.10.□.100,0
Bending radii listed above can be combined with every chain width!

Series 27i - snap-open along inner radius

Part No.	Bj [mm]	Ba [mm]	R [mm] Bending Radii
27i.05.□.0	50	66	063 075 100
27i.07.□.0	75	91	125 150 175
27i.10.□.0	100	116	200 250
27i.12.□.0	125	141	Radii for all widths!
27i.15.□.0	150	166	
27i.17.□.0	175	194	
27i.20.□.0	200	219	

Supplement Part No. with required radius. Example: 27i.10.□.100,0
Bending radii listed above can be combined with every chain width!

Series 27 - snap-open along outer radius

Part No.	Bj [mm]	Ba [mm]	R [mm] Bending Radii
27.05.□.0	50	66	063 075 100
27.07.□.0	75	91	125 150 175
27.10.□.0	100	116	200 250
27.12.□.0	125	141	Radii for all widths!
27.15.□.0	150	166	
27.17.□.0	175	194	
27.20.□.0	200	219	

Supplement Part No. with required radius. Example: 27.10.□.100,0
Bending radii listed above can be combined with every chain width!

Part No. structure

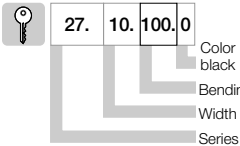

Order example 3,0 m complete E-Chain®
(indicate chain-lengths or number of links)

3,0 m (54 links) Series 27.10.100.0

+ 2 separators 261 assembled each 2nd link

+ 1 set mounting brackets + tie-wrap plates 2610.34.PZB

Pitch = 56 mm Links per m = 18 Chain length = $S/2 + K$

R	063	075	100	125	150	175	200	250
H⁺	180	200	250	300	350	400	450	550
D	140	150	175	200	225	250	275	325
K	335	375	475	550	650	750	825	925

The required clearance height is $H_F = H + 35$ mm (with 2,0 kg/m fill weight). Please consult igus® if space is particularly restricted.

Installation Dimensions

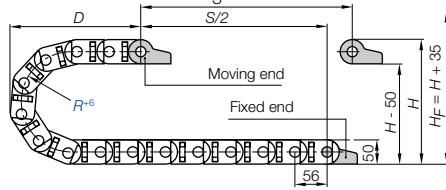

35

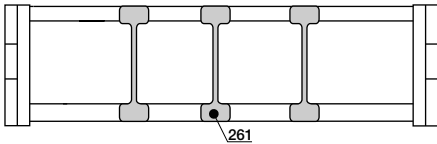

Vertical separator

unassembled	260
assembled	261

Interior Separation

Full program ▶ page 5.118



E2 medium classic
Inner height: 35 mm

26...3.PZ(B)

Moving end

26...4.PZ(B)

Fixed end

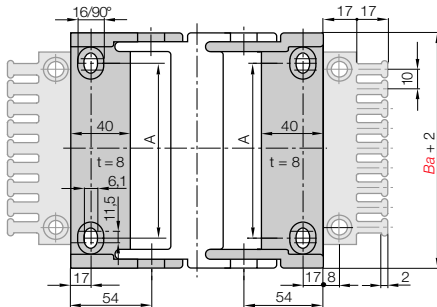

Moving end (with bore)

26...3.PZ(B)

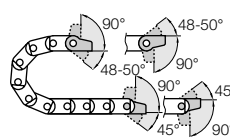

26...4.PZ(B)
Fixed end (with pin)

Mounting Brackets

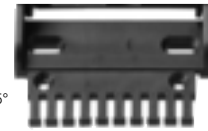

Polymer pivoting, with or without strain relief tiwrap plates

For E-Chain®	Part No. full set with tiwrap plate	Part No. with tiwrap plate + 10 cable tiwraps	Part No. full set without tiwrap plate	Dimension A [mm]
26/27/27i.05. ▶	2605.34.PZB	2605.34.PZBK1	2605.34.PZ	30
26/27/27i.07. ▶	2607.34.PZB	2607.34.PZBK1	2607.34.PZ	55
26/27/27i.10. ▶	2610.34.PZB	2610.34.PZBK1	2610.34.PZ	80
26/27/27i.12. ▶	2612.34.PZB	2612.34.PZBK1	2612.34.PZ	105
26/27/27i.15. ▶	2615.34.PZB	2615.34.PZBK1	2615.34.PZ	130
26/27/27i.17. ▶	2617.34.PZB	2617.34.PZBK1	2617.34.PZ	155
26/27/27i.20. ▶	2620.34.PZB	2620.34.PZBK1	2620.34.PZ	180

Tiwrap plates are possible at the moving end and/or the fixed end!

Part No. structure

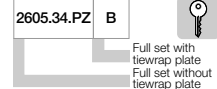

Full set, for both ends:

2605.[34].[PZB] (+ tiwrap plates)

Single-part order:

2605.[3].[PZB] (+ tiwrap plates)

Mounting bracket with bore

2605.[4].[PZB] (+ tiwrap plates)

Mounting bracket with pin



Interior separation with full-width shelves and shelves possible



Polymer mounting bracket, locking



KMA mounting bracket available with C-profile

Additional Features

For more features ▶ see link below



chapter 10

chapter 9

Phone +49- (0) 22 03-96 49-800
Fax +49- (0) 22 03-96 49-222

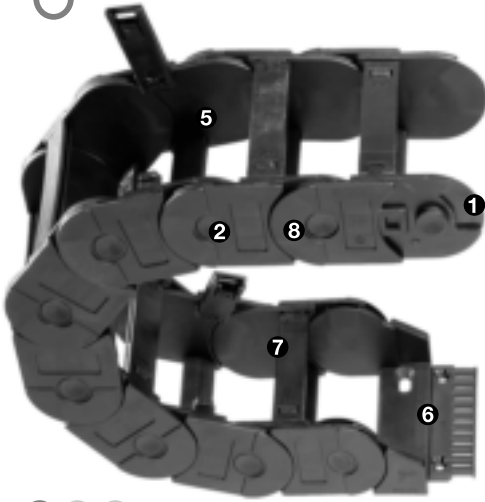

- ❶ Double stop dog for long unsupported length
- ❷ Large pins for long service life
- ❸ Lateral glide surfaces for side-mounted operation
- ❹ Available with extender crossbars for large hoses
- ❺ Cable-friendly, smooth interior
- ❻ Integrated strain relief possible
- ❼ Serie 340 snap-open along inner radius can be combined with Serie 350 snap-open along outer radius, accessible from the top
- ❽ Dirt-repellent, contoured exterior

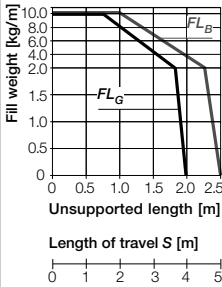

Unsupported length

FL_G = with straight upper run

FL_B = with permitted sag

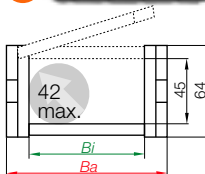
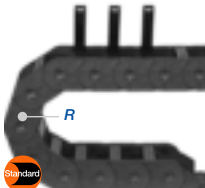
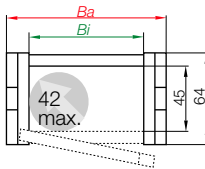
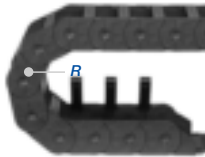
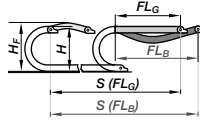

Series 340 - snap-open along inner radius

Part No.	Bi [mm]	Ba [mm]	R [mm] Bending Radii
340.050.□.0	50	70	075 100 125
340.075.□.0	75	95	150 200 250
340.100.□.0	100	120	300
340.115.□.0	115	135	Radii for all widths!
340.125.□.0	125	145	
340.150.□.0	150	170	
340.175.□.0	175	195	
340.200.□.0	200	220	
340.225.□.0	225	245	
340.250.□.0	250	270	

Supplement Part No. with required radius. Example: 340.050.100.0
Bending radii listed above can be combined with every chain width!

Series 350 - snap-open along outer radius

Part No.	Bi [mm]	Ba [mm]	R [mm] Bending Radii
350.050.□.0	50	70	075 100 115*
350.075.□.0	75	95	125 150 200
350.100.□.0	100	120	250 300
350.115.□.0	115	135	Radii for all widths!
350.125.□.0	125	145	
350.150.□.0	150	170	
350.175.□.0	175	195	
350.200.□.0	200	220	* not for Series 350.100
350.225.□.0	225	245	
350.250.□.0	250	270	

Supplement Part No. with required radius. Example: 350.150.100.0
Bending radii listed above can be combined with every chain width!

Part No. structure



350. 150.100.0

- Color black
- Bending radius
- Width
- Series



Order example 5,0 m complete E-Chain®

(indicate chain-lengths or number of links)

5,0 m (75 links) **Series 350.150.100.0**

+ 2 separators **311** assembled each 2nd link

+ 1 set mounting brackets + tie-wrap plates **3150.34.PZB**

Pitch = 67 mm Links per m = 15 Chain length = $\frac{S}{2} + K$

R	075	100	115*	125	150	200	250	300
H*5	215	265	294	315	365	465	565	665
D	150	200	215	225	250	300	350	400
K	400	500	550	650	725	875	1050	1225

The required clearance height is $H_F = H + 40$ mm (with 2,5 kg/m fill weight). Please consult igus® if space is particularly restricted.

* not for Series 350.100

Installation Dimensions

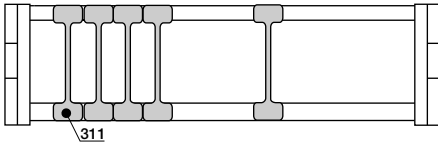
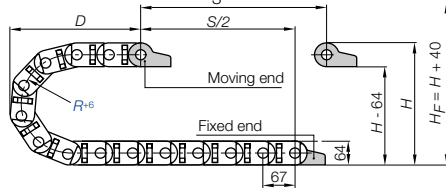

Vertical separator

unassembled	301
assembled	311



Interior Separation

Full program ▶ page 5.130



3...3.PZ(B)

Moving end

3...4.PZ(B)

Fixed end

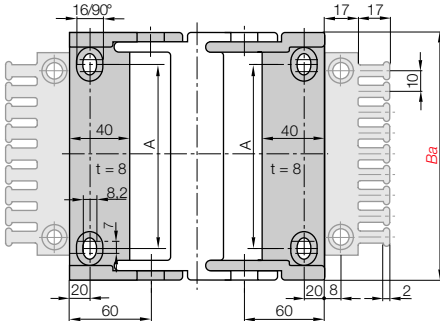

Moving end (with bore)

3...3.PZ(B)

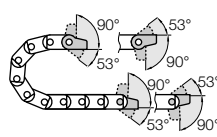

3...4.PZ(B)
Fixed end (with pin)

Mounting Brackets

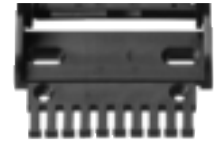

Polymer pivoting, with or without strain relief tiwrap plates

For E-Chain®	Part No. full set with tiwrap plate	Part No. with tiwrap plate + 10 cable tiwraps	Part No. full set without tiwrap plate	Dimension A [mm]
340/350.050. ▶	3050.34.PZB	3050.34.PZBK1	3050.34.PZ	28
340/350.075. ▶	3075.34.PZB	3075.34.PZBK1	3075.34.PZ	53
340/350.100. ▶	3100.34.PZB	3100.34.PZBK1	3100.34.PZ	78
340/350.115. ▶	3115.34.PZB	3115.34.PZBK1	3115.34.PZ	93
340/350.125. ▶	3125.34.PZB	3125.34.PZBK1	3125.34.PZ	103
340/350.150. ▶	3150.34.PZB	3150.34.PZBK1	3150.34.PZ	128
340/350.175. ▶	3175.34.PZB	3175.34.PZBK1	3175.34.PZ	153
340/350.200. ▶	3200.34.PZB	3200.34.PZBK1	3200.34.PZ	178
340/350.225. ▶	3225.34.PZB	3225.34.PZBK1	3225.34.PZ	203
340/350.250. ▶	3250.34.PZB	3250.34.PZBK1	3250.34.PZ	228

Tiwrap plates are possible at the moving end and/or the fixed end!

Part No. structure

3050.34.PZ B

Full set with tiwrap plate
Full set without tiwrap plate

Full set, for both ends:

3050.34.PZB (+ tiwrap plates)

Single-part order:

3050.3.PZB (+ tiwrap plates)

Mounting bracket with bore

3050.4.PZB (+ tiwrap plates)

Mounting bracket with pin



Interior separation with full-width shelves and shelves



Mounting bracket polymer locking available



KMA mounting bracket available with C-profile

Additional Features

For more features
▶ see link below



45

E2 medium classic
Inner height: 45 mm

Phone +49- (0) 22 03-96 49-800
Fax +49- (0) 22 03-96 49-222



chapter 10



chapter 9

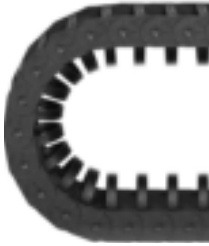

340.150...

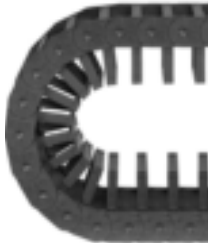

340.175...



350.150...



350.175...

Extender crossbar Series 340/350 E2 medium - for larger hoses or increased inner chain heights

igus® Extender Chains were developed to provide a very smooth hose guidance. This type of extender chain is suitable for hoses with an outside diameter up to 115 mm. Hose guidance for inside radius (Series 350) as well as outside radius (Series 340) can be easily managed. Based on its design, a smooth movement of the chain is only possible with outside radius guidance. If outside radius guidance is used, the extenders of the chain links must be supported separately to avoid touching down on the surface below. We gladly assist you with your selection for a suitable guide troughs and your system's design.

Phone +49- (0) 22 03-96 49-800
Fax +49- (0) 22 03-96 49-222

igus® GmbH
51147 Cologne

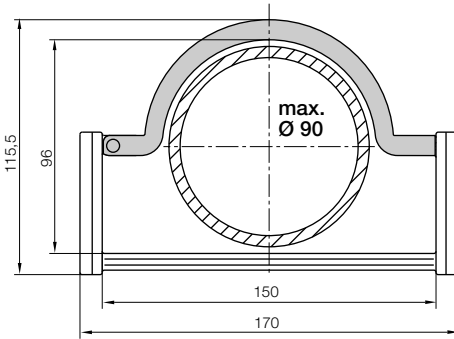

Cross section of a chain link with rounded extender crossbar. Crossbar Part No.: 350.150.D090

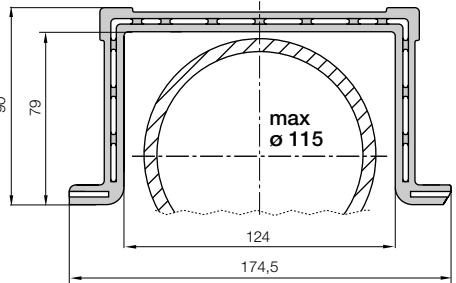

Cross section of a chain link with square extender crossbar. Crossbar Part No.: 350.175.D115*

Part No. structure (extender crossbar)

350. 150.D090. 100 0

- Color black
- Radius
- Crossbar inside Ø
- Width
- Series

Order example 5,0 m complete E-Chain® (indicate chain-lengths or number of links)

5,0 m (75 links) Series 350.150.D090.100.0

+ 1 set mounting brackets + tie-wrap plates 3150.34.PZB

For E-Chain® Series	Ø max. hoses [mm]	Fastening method	Form	Bending Radii [mm]
340.150.	90	inner radius	round	150 200 250 300
340.175.	115	inner radius	square	200 250 300
350.150.	90	outer radius	round	075 100 125 150 200 250
350.175.	115	outer radius	square	075 100 125 150 200 250

*Part No. 350.175.RD115 also available with rounded extender bars. Extenders suitable for Series 3400/3500. Please contact us for further information.





igus® E-Chain® with extender-crossbar - safe guide for big hoses



igus® E2 E-Chains® for various applications and installations



E2 medium classic
Inner height: 45 mm

Phone +49- (0) 22 03-96 49-800
Fax +49- (0) 22 03-96 49-222



▶ chapter 10



▶ chapter 9

igus® E-ChainSystems®

Phone +49- (0) 22 03-96 49-800
Fax +49- (0) 22 03-96 49-222

igus® GmbH
51147 Cologne

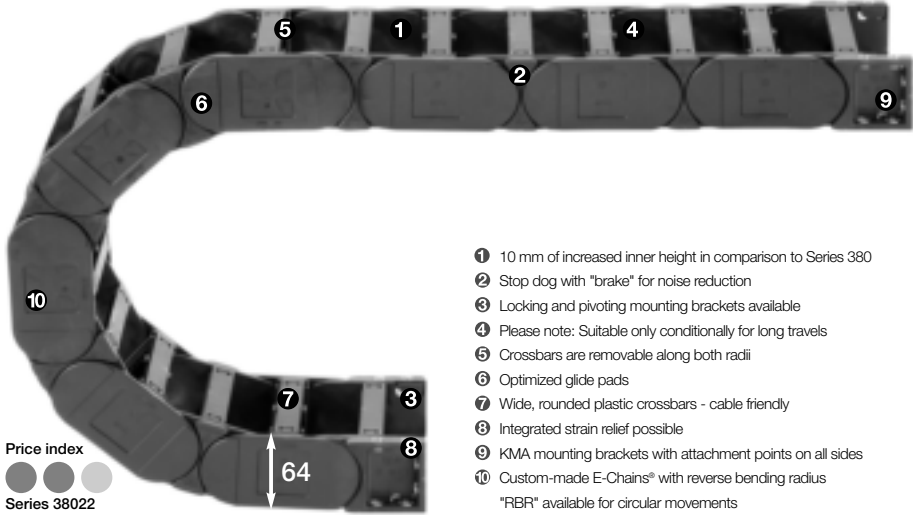

Price index
Series 38022

- ❶ 10 mm of increased inner height in comparison to Series 380
 - ❷ Stop dog with "brake" for noise reduction
 - ❸ Locking and pivoting mounting brackets available
 - ❹ Please note: Suitable only conditionally for long travels
 - ❺ Crossbars are removable along both radii
 - ❻ Optimized glide pads
 - ❼ Wide, rounded plastic crossbars - cable friendly
 - ❼ Integrated strain relief possible
 - ❽ KMA mounting brackets with attachment points on all sides
 - ❿ Custom-made E-Chains® with reverse bending radius
- "RBR" available for circular movements

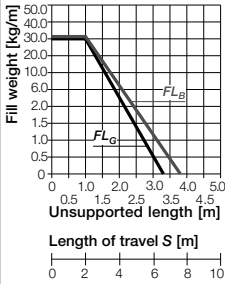

Unsupported length
 FL_G = with straight upper run
 FL_B = with permitted sag

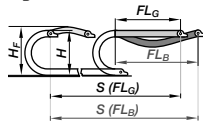

Serie 38022 - crossbars every link

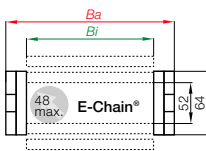
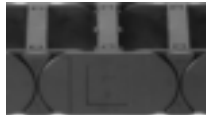

Part No.	Bi [mm]	Ba [mm]	R [mm] Bending Radii
38022.05.	<input type="checkbox"/> .0	50	76
38022.06.	<input type="checkbox"/> .0	68	94
38022.07.	<input type="checkbox"/> .0	75	101
38022.087.	<input type="checkbox"/> .0	87	114
38022.10.	<input type="checkbox"/> .0	100	126
38022.11.	<input type="checkbox"/> .0	108	134
38022.112.	<input type="checkbox"/> .0	112	139
38022.12.	<input type="checkbox"/> .0	125	151
38022.137.	<input type="checkbox"/> .0	137	164
38022.15.	<input type="checkbox"/> .0	150	176
38022.162.	<input type="checkbox"/> .0	162	189
38022.17.	<input type="checkbox"/> .0	168	194
38022.18.	<input type="checkbox"/> .0	175	201
38022.187.	<input type="checkbox"/> .0	187	214
38022.20.	<input type="checkbox"/> .0	200	226
38022.212.	<input type="checkbox"/> .0	212	239
38022.23.	<input type="checkbox"/> .0	225	251
38022.237.	<input type="checkbox"/> .0	237	264
38022.25.	<input type="checkbox"/> .0	250	276
38022.262.	<input type="checkbox"/> .0	262	289
38022.28.	<input type="checkbox"/> .0	275	301
38022.29.	<input type="checkbox"/> .0	287	314
38022.30.	<input type="checkbox"/> .0	300	326
38022.312.	<input type="checkbox"/> .0	312	339
38022.325.	<input type="checkbox"/> .0	325	351
38022.337.	<input type="checkbox"/> .0	337	364
38022.350.	<input type="checkbox"/> .0	350	376
38022.362.	<input type="checkbox"/> .0	362	389
38022.375.	<input type="checkbox"/> .0	375	402
38022.387.	<input type="checkbox"/> .0	387	414
38022.400.	<input type="checkbox"/> .0	400	426

Radii for all widths!

Part No. structure
38022.400.300.0
 Color black
 Bending radius
 Width
 Series

Order example 5,0 m complete E-Chain®
 (indicate chain-lengths or number of links)

5,0 m (75 links) Series 38022.400.300.0
 + 2 separators 382213 assembled each 2nd link
 + 1 set KMA mounting brackets 38022.400.[1].12.[C]
 (with odd numbers of links and integrated C-profile)

Supplement Part No. with required radius. Example: 38022.400.[300].0
 Bending radii listed above can be combined with every chain width!

Pitch = 67 mm Links per m = 15 Chain length = $S/2 + K$

R	075	100	115	125	150	170	200	215	250	300	350
H_{x25}^0	215	265	295	315	365	405	465	495	565	665	765
D	174	199	214	224	249	269	299	314	349	399	449
K	370	450	500	530	610	670	765	810	920	1080	1235

The required clearance height is $H_F = H + 40$ mm (bei 2,0 kg/m Zusatzlast). Please consult igus® if space is particularly restricted.

Installation Dimensions

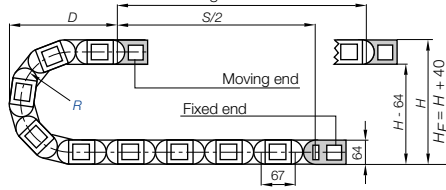

52

System E4/00
Inner height: 52 mm

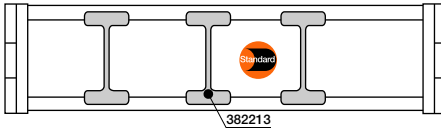

Vertical separator
unassembled 382212
assembled 382213

Interior Separation

Full program ▶ page 12.16



38022...2
Fixed end

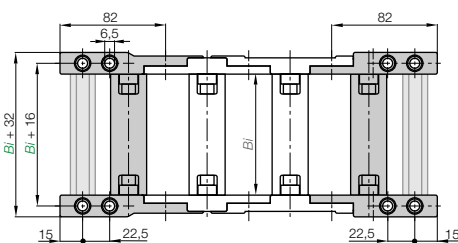

38022...1
Moving end

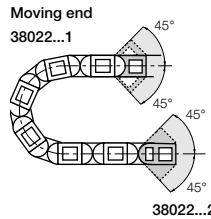

Mounting Brackets



KMA pivoting - mounting with
M6 socket head cup bolt
(KMA = Polymer Metal Mounting Bracket)

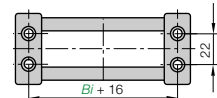

For E-Chain® width-index	Part No. full set optional with C-profile	Bi [mm]
.05.	38022.05 □.12.C	50
.06.	38022.06 □.12.C	68
.07.	38022.07 □.12.C	75
.087.	38022.087 □.12.C	87
.10.	38022.10 □.12.C	100
.11.	38022.11 □.12.C	108
.112.	38022.112 □.12.C	112
.12.	38022.12 □.12.C	125
.137.	38022.137 □.12.C	137
.15.	38022.15 □.12.C	150
.162.	38022.162 □.12.C	162
.17.	38022.17 □.12.C	168
.18.	38022.18 □.12.C	175
.187.	38022.187 □.12.C	187
.20.	38022.20 □.12.C	200
.212.	38022.212 □.12.C	212

For E-Chain® width-index	Part No. full set optional with C-profile	Bi [mm]
.23.	38022.23 □.12.C	225
.237.	38022.237 □.12.C	237
.25.	38022.25 □.12.C	250
.262.	38022.262 □.12.C	262
.28.	38022.28 □.12.C	275
.29.	38022.29 □.12.C	287
.30.	38022.30 □.12.C	300
.312.	38022.312 □.12.C	312
.325.	38022.325 □.12.C	325
.337.	38022.337 □.12.C	337
.350.	38022.350 □.12.C	350
.362.	38022.362 □.12.C	362
.375.	38022.375 □.12.C	375
.387.	38022.387 □.12.C	387
.400.	38022.400 □.12.C	400

Part No. structure

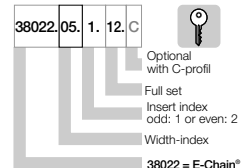

Note: The E4/00 System may end with either an inner side or an outer side link. Keep in mind that an outer side link always forms the first chain link at the moving end. The Part No. depends on an even or odd number of links. Please insert: index odd/even: **1** for odd number of links **2** for even number of links

Phone +49- (0) 22 03-96 49-800
Fax +49- (0) 22 03-96 49-222



Interior separation with locking shelves



Optional: Mounting bracket KMA, locking, Part No. 39022.XX

Additional Features

igus® E-ChainSystems®

Phone +49- (0) 22 03-96 49-800
Fax +49- (0) 22 03-96 49-222

igus® GmbH
51147 Cologne

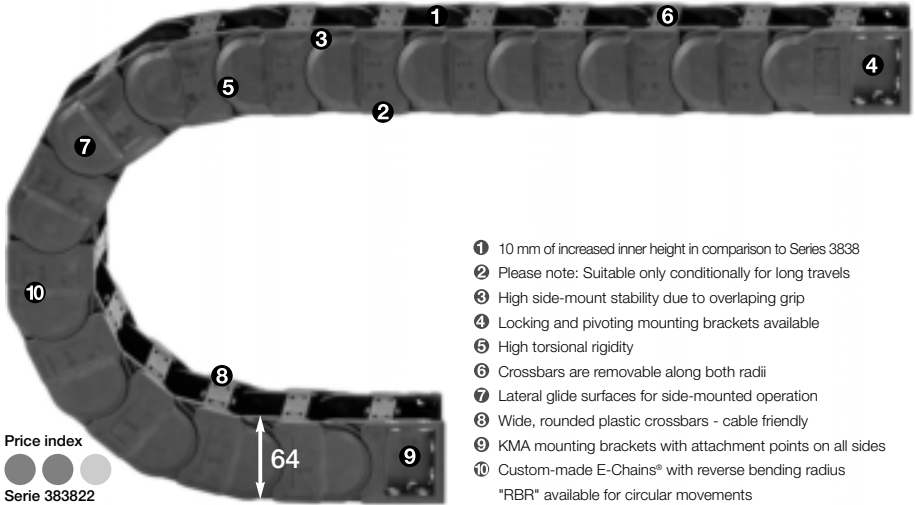

- ❶ 10 mm of increased inner height in comparison to Series 3838
 - ❷ Please note: Suitable only conditionally for long travels
 - ❸ High side-mount stability due to overlapping grip
 - ❹ Locking and pivoting mounting brackets available
 - ❺ High torsional rigidity
 - ❻ Crossbars are removable along both radii
 - ❼ Lateral glide surfaces for side-mounted operation
 - ❽ Wide, rounded plastic crossbars - cable friendly
 - ❾ KMA mounting brackets with attachment points on all sides
 - ❿ Custom-made E-Chains® with reverse bending radius
- "RBR" available for circular movements

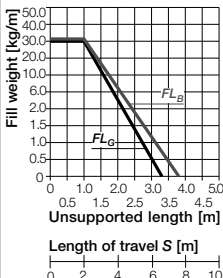

Unsupported length

FL_G = with straight upper run

FL_B = with permitted sag

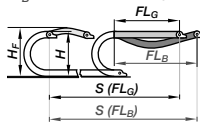

Serie 383822 - crossbars every link

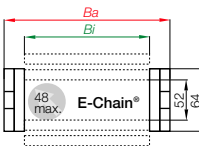

Part No.	Bi [mm]	Ba [mm]	R [mm] Bending Radii
383822.05.	<input type="checkbox"/> .0	50	77
383822.06.	<input type="checkbox"/> .0	68	95
383822.07.	<input type="checkbox"/> .0	75	102
383822.087.	<input type="checkbox"/> .0	087	115
383822.10.	<input type="checkbox"/> .0	100	127
383822.11.	<input type="checkbox"/> .0	108	135
383822.112.	<input type="checkbox"/> .0	112	140
383822.12.	<input type="checkbox"/> .0	125	152
383822.137.	<input type="checkbox"/> .0	137	165
383822.15.	<input type="checkbox"/> .0	150	177
383822.162.	<input type="checkbox"/> .0	162	190
383822.17.	<input type="checkbox"/> .0	168	195
383822.18.	<input type="checkbox"/> .0	175	202
383822.187.	<input type="checkbox"/> .0	187	215
383822.20.	<input type="checkbox"/> .0	200	227
383822.212.	<input type="checkbox"/> .0	212	240
383822.23.	<input type="checkbox"/> .0	225	252
383822.237.	<input type="checkbox"/> .0	237	265
383822.25.	<input type="checkbox"/> .0	250	277
383822.262.	<input type="checkbox"/> .0	262	290
383822.28.	<input type="checkbox"/> .0	275	302
383822.29.	<input type="checkbox"/> .0	287	315
383822.30.	<input type="checkbox"/> .0	300	327
383822.312.	<input type="checkbox"/> .0	312	340
383822.325.	<input type="checkbox"/> .0	325	352
383822.337.	<input type="checkbox"/> .0	337	365
383822.350.	<input type="checkbox"/> .0	350	377
383822.362.	<input type="checkbox"/> .0	362	390
383822.375.	<input type="checkbox"/> .0	375	402
383822.387.	<input type="checkbox"/> .0	387	415
383822.400.	<input type="checkbox"/> .0	400	427

Radii for all widths!

Part No. structure

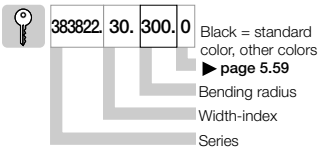

Black = standard color, other colors ▶ page 5.59
Bending radius
Width-index
Series

Order example 4,0 m complete E-Chain®
(indicate chain-lengths or number of links)

4,0 m (60 links) Series 383822.30.300.0
+ 2 separators 382213 assembled each 2nd link
+ 1 set KMA mounting brackets 383822.30.12.0
(with integrated C-profile)

Supplement Part No. with required radius. Example: 383822.30.300.0
Bending radii listed above can be combined with every chain width!

Pitch = 67 mm Links per m = 15 Chain length = $S/2 + K$

R	075	100	115	125	150	170	200	215	250	300	350
H_{x25}^0	215	265	295	315	365	405	465	495	565	665	765
D	174	199	214	224	249	269	299	314	349	399	449
K	370	450	500	530	610	670	765	810	920	1080	1235

The required clearance height is $H_F = H + 40$ mm (with 2,0 kg/m fill weight). Please consult igus® if space is particularly restricted.

Installation Dimensions

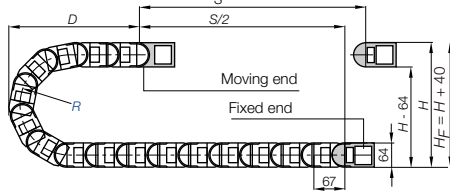

52

System E4/4
Inner height: 52 mm

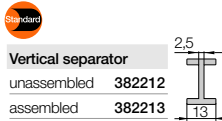
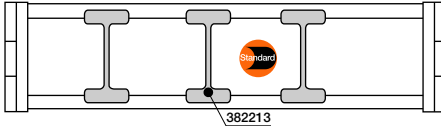

Interior Separation

Full program ▶ page 12.16



383822...2

Fixed end

383822...1

Moving end

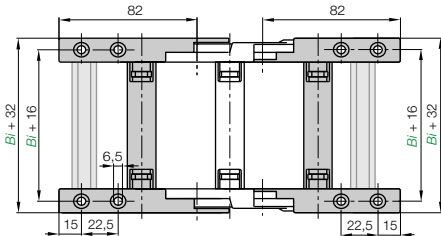

Moving end

383822...1

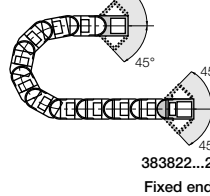

Mounting Brackets



KMA pivoting - mounting with M6 socket head cup bolt
(KMA = Polymer Metal Mounting Bracket)

For E-Chain® Part No. full set		Bi
width-index	optional with C-profile	[mm]
.05.	▶ 383822.05 .12.C	50
.06.	▶ 383822.06 .12.C	68
.07.	▶ 383822.07 .12.C	75
.087.	▶ 383822.087 .12.C	87
.10.	▶ 383822.10 .12.C	100
.11.	▶ 383822.11 .12.C	108
.112.	▶ 383822.112 .12.C	112
.12.	▶ 383822.12 .12.C	125
.137.	▶ 383822.137 .12.C	137
.15.	▶ 383822.15 .12.C	150
.162.	▶ 383822.162 .12.C	162
.17.	▶ 383822.17 .12.C	168
.18.	▶ 383822.18 .12.C	175
.187.	▶ 383822.187 .12.C	187
.20.	▶ 383822.20 .12.C	200
.212.	▶ 383822.212 .12.C	212

For E-Chain® Part No. full set		Bi
width-index	optional with C-profile	[mm]
.23.	▶ 383822.23 .12.C	225
.237.	▶ 383822.237 .12.C	237
.25.	▶ 383822.25 .12.C	250
.262.	▶ 383822.262 .12.C	262
.28.	▶ 383822.28 .12.C	275
.29.	▶ 383822.29 .12.C	287
.30.	▶ 383822.30 .12.C	300
.312.	▶ 383822.312 .12.C	312
.325.	▶ 383822.325 .12.C	325
.337.	▶ 383822.337 .12.C	337
.350.	▶ 383822.350 .12.C	350
.362.	▶ 383822.362 .12.C	362
.375.	▶ 383822.375 .12.C	375
.387.	▶ 383822.387 .12.C	387
.400.	▶ 383822.400 .12.C	400

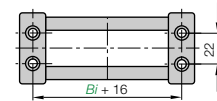

Part No. structure

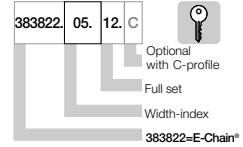

Full set, for both ends:

383822.05.12

Single-part order:

383822.05.1

Mounting bracket with bore

383822.05.2

Mounting bracket with pin

Phone +49- (0) 22 03-96 49-800
Fax +49- (0) 22 03-96 49-222



Interior separation with locking shelves



Optional: Mounting bracket KMA, locking, Part No. 393822.XX

Weitere Features



Vertical separator	
unassembled	382212
assembled	382213



Option 1: Vertical separator

Vertical separators are used if a vertical subdivision of the E-Chain® interior is required - By standard vertical separators are assembled every other E-Chain® link

- **Standard separator 382212** for E-Chains® offers safe stability due to its wide base design, also when used with thick cables or hoses

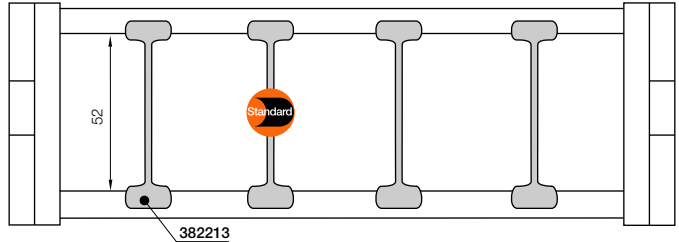

Separator, slotted	
unassembled	38221
assembled	38222



Locking separator	
unassembled	38228
assembled	38229



Locking vertical separator	
unassembled	382214
assembled	382215



Side plate	
unassembled	38223
assembled	38224



Slotted separator	
unassembled	38225
assembled	38226



Option 2: Shelves

For applications involving many cables with different diameters. The Shelves can be arranged elevator-shifted with different bottoms within the entire E-Chain® width

- Shelf 2210.X can be combined with Separator, slotted 38221, Locking separator 38228, Locking vertical separator 382214, Side plate 38224 and Slotted separator 38225

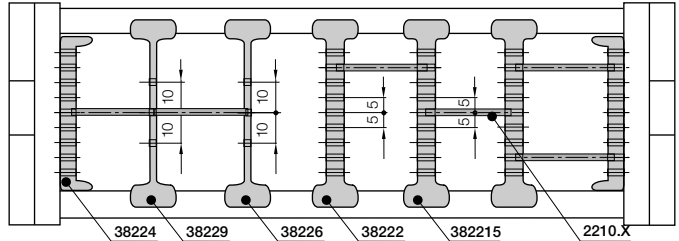

Shelf	
X	Width
X - 7	Inner width
t = 2,5	Thickness

Width X [mm]	Part No. unassembled	Part No. assembled	Width X [mm]	Part No. unassembled	Part No. assembled
18	2200.18	2210.18	58	2200.58	2210.58
23	2200.23	2210.23	68	2200.68	2210.68
28	2200.28	2210.28	73	2200.73	2210.73
33	2200.33	2210.33	88	2200.88	2210.88
38	2200.38	2210.38	99	2200.99	2210.99
43	2200.43	2210.43	124	2200.124	2210.124
48	2200.48	2210.48	149	2200.149	2210.149

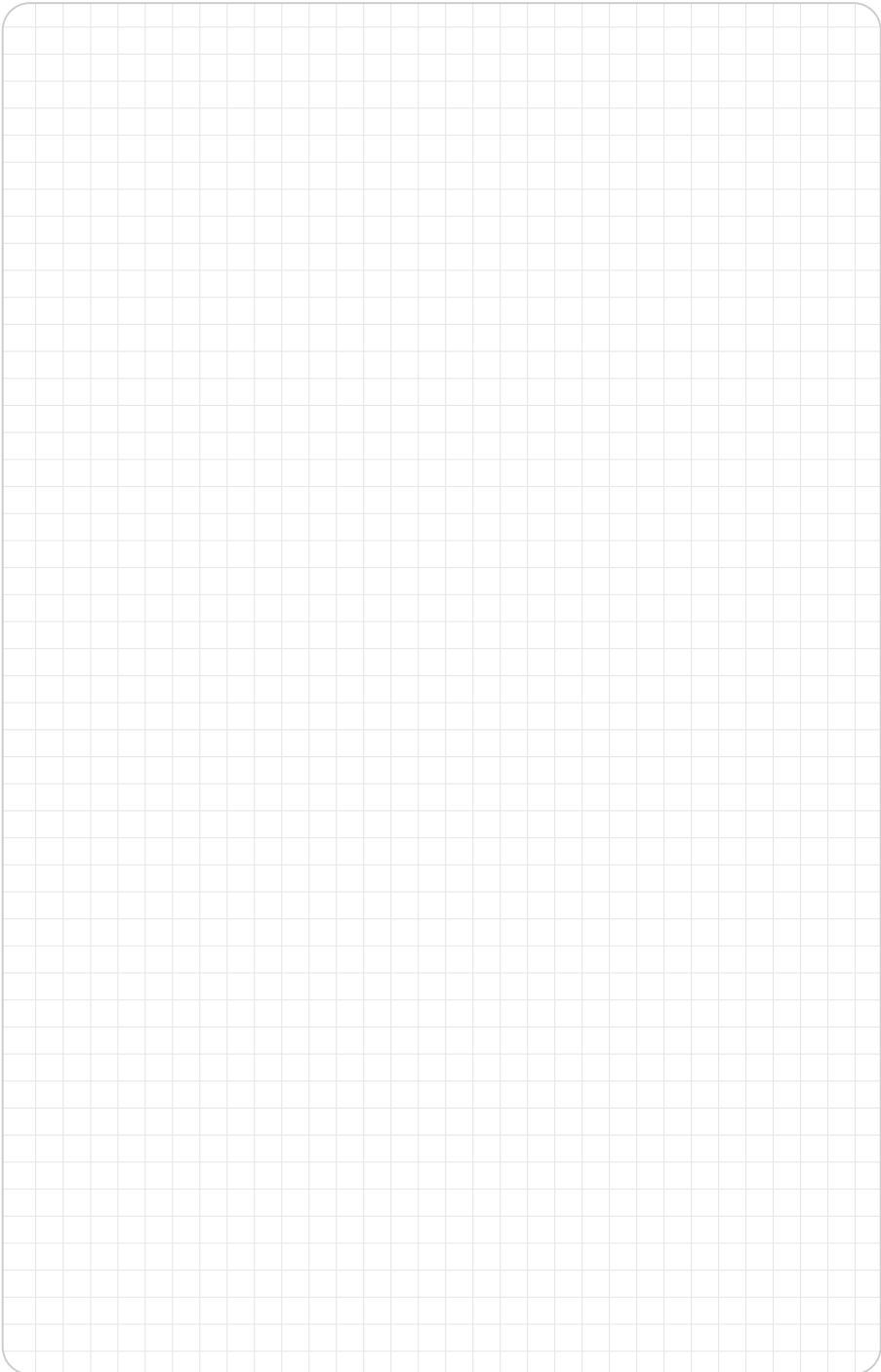

38022 / 383822
Interior Separation

Phone +49- (0) 22 03-96 49-800
Fax +49- (0) 22 03-96 49-222



igus® E-ChainSystems®

Phone +49- (0) 22 03-96 49-800
Fax +49- (0) 22 03-96 49-222

igus® GmbH
51147 Cologne

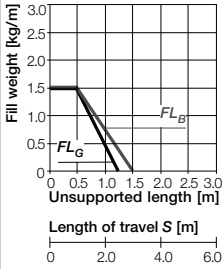
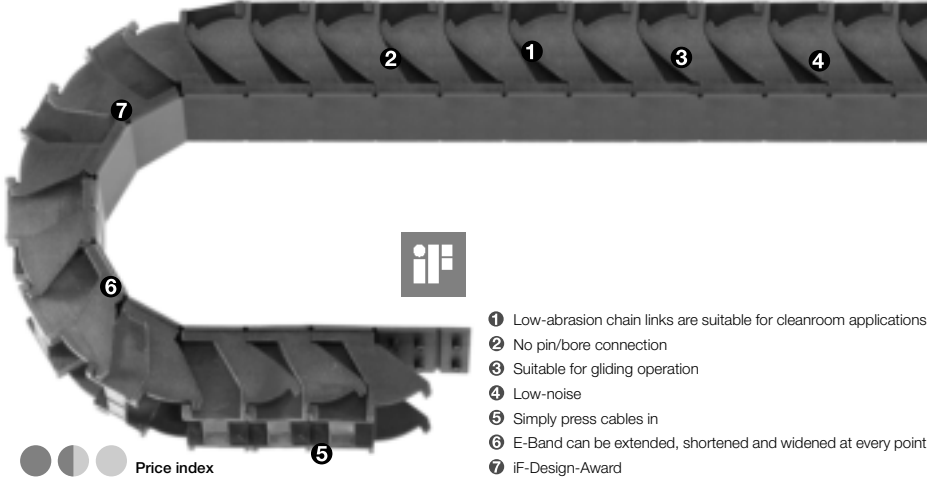

Unsupported length

FL_G = with straight upper run

FL_B = with permitted sag

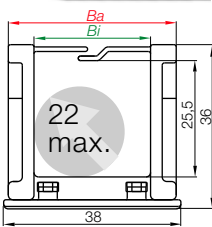
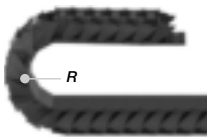
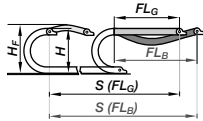

E-Band - split crossbar along the outer radius

Part No.	Bi [mm]	Ba [mm]	R [mm] Bending Radii
EB20.025.□.0	25	36	045 063* 075*
			100* 125* 150*
			175* 200*

Radii for all widths!

*available upon request!

Supplement Part No. with required radius. Example: EB20.025.[045].0
Bending radii listed above can be combined with every chain width!

Part No. structure

EB20.025.045.0

- Color black
- Bending radius
- Width
- Series



Order example 2,0 m complete E-Chain®

(indicate chain-lengths or number of links)

1,0 m (40 links) Series EB20.025.045.0

+ 1 set mounting brackets EB20.025.12.PZ

Pitch = 25 mm Links per m = 40 (2 Bänder/m) Chain length = $S/2 + K$

R	045	063	075	100	125	150	175	200
H	162	198	222	272	322	372	422	472
D	110	128	140	165	190	215	240	265
K	200	250	300	375	450	525	600	675

The required clearance height is $H_F = H + 30$ mm (with 0,3 kg/m fill weight). Please consult igus® if space is particularly restricted.

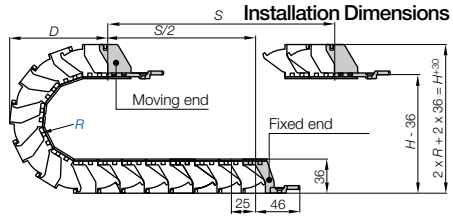

25,5

E-Band
Inner height: 25,5 mm

EB20.025.2.PZ
Fixed end

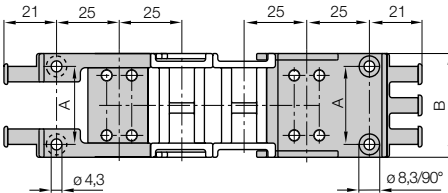

EB20.025.1.PZ
Moving end

Moving end
EB20.025.1.PZ

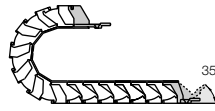

EB20.025.2.PZ
Fixed end

Mounting Brackets



One-piece mounting brackets with strain relief tiewrap plates

For E-Chain®	Part No.	Dimension A [mm]	Dimension B [mm]
	full set with tiewrap plate		
EB20.025.	EB20.025.12.PZ	26	36

Tiewrap plates are possible at the moving end and/or the fixed end!

Phone +49- (0) 22 03-96 49-800
Fax +49- (0) 22 03-96 49-222



Additional Features

For more features
▶ see link below



about.

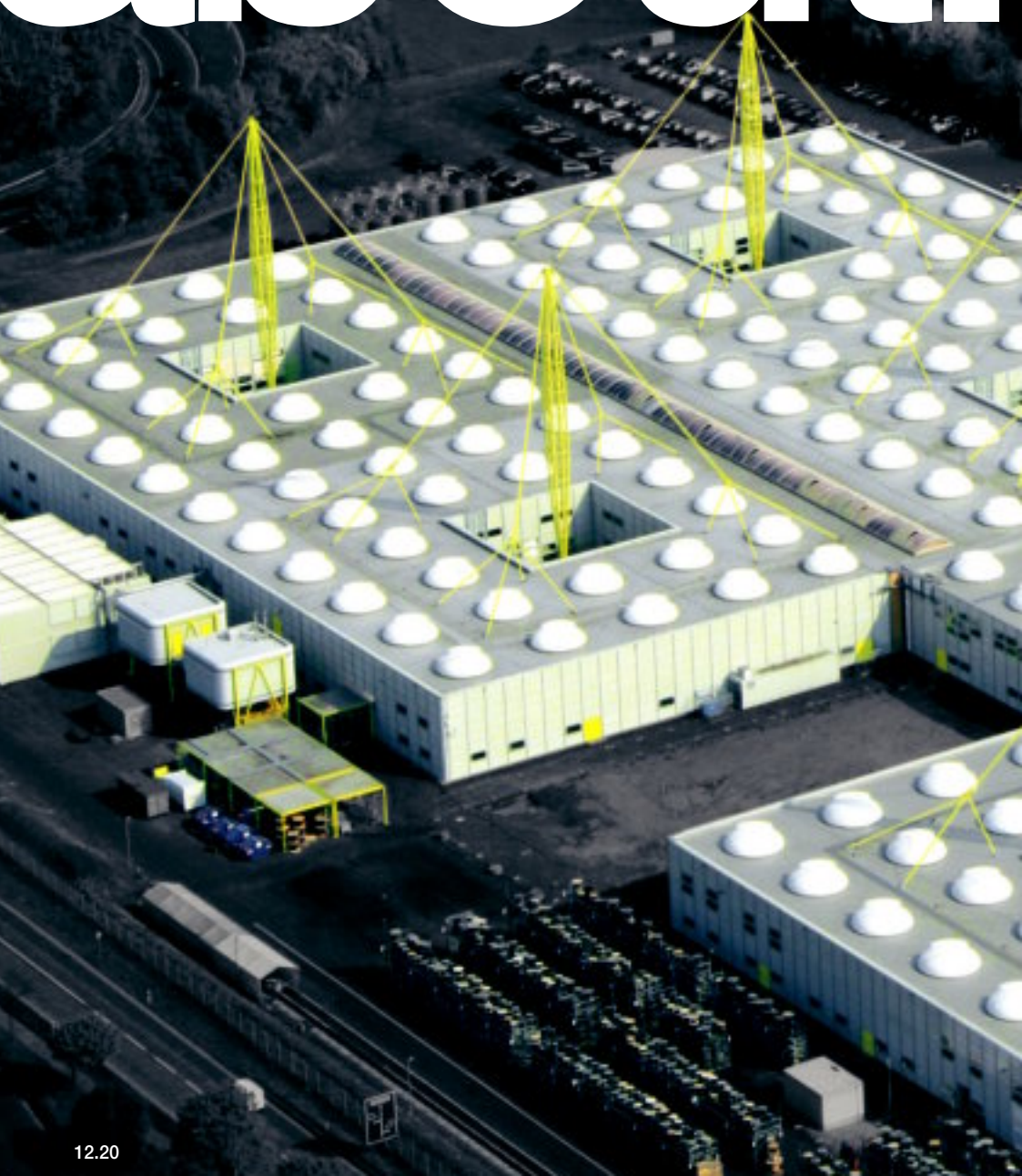



igus[®]

igus®.desi

E-Chains® are lifelines to automated systems ► from page 1.1

E-Chains® are the umbilical cord of modern machines. They are constantly moving and supply power, data and energy. igus® has been developing, producing and testing polymer E-Chains® since 1971. Our expert knowledge is being refined continuously with the help of our customers to constantly improve our product range.

Universal applications for igus® E-Chains®

- Multitude of possibilities in terms of movement and length
- To carry sensitive bus, data cables and fibre optics cables and energy sources such as electricity, gas, air and liquids
- To accommodate very high dynamic loads and stringent service life requirements
- Handle very different environments and climates
- Space-saving installation
- High speeds and accelerations can be achieved
- Modular systems allow quick assembly and retrofit

Save time and money when purchasing and utilising E-Chains®!

- Innovative products that can be assembled quickly
- Rapid delivery time - saves you storage costs
- Large range of products - find the right solution immediately
- System quotes, including made-to-measure production and "turnkey" assembly
- Rapid system design and support with an ever-growing close-knit network of local sales engineers worldwide



Find a video online

► www.igus.de/automated



The award-winning igus®

E-ChainSystems® are certified and tested

Assembled to your exact requirements. Delivered in 1-3 days!

► page 7.1

igning.

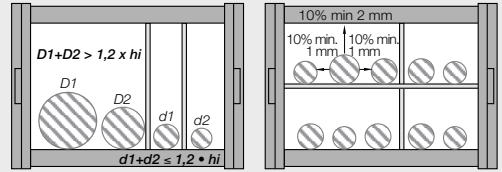

igus® interior separation systems significantly lengthen the life cycle of cables and enable neat layout of E-Chains®. Filling guidelines ▶ from page 1.29

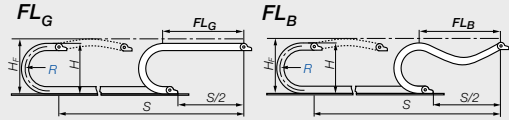

Large unsupported lengths with igus® E-Chains®. Notes, calculations and load diagrams are provided ▶ from page 1.12

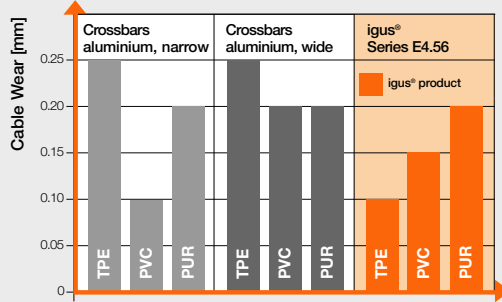

Optimum service life for cables - Reduce cable wear with igus® polymer crossbars

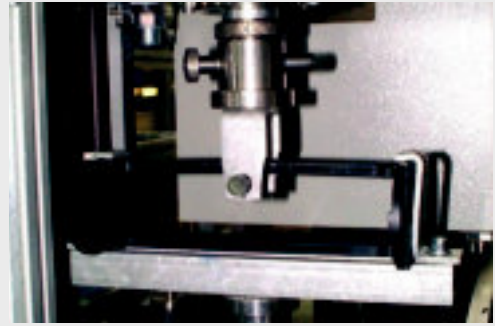

Proven toughness - strength testing in the igus® laboratory

igus®.acce

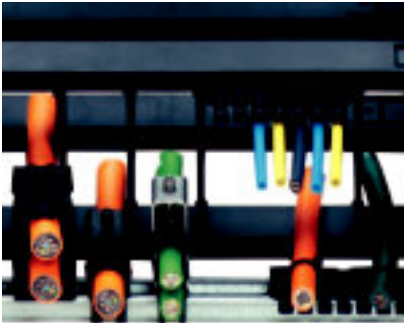

Matching accessories for your igus® E-ChainSystem®

Ranging from reliable strain-relief systems for cables through interior separators for proper division of E-Chains® to AUTO-GLIDE crossbars for long travels without guide troughs or special igus® guide troughs for extra-long travels. igus® offers the right solution for every application. The large accessory kit from igus® permits upgrading of your E-Chain® to a high-tech solution. Matched specially with igus® E-Chains®, igus® accessories have been tried and tested in practical applications for many years now.

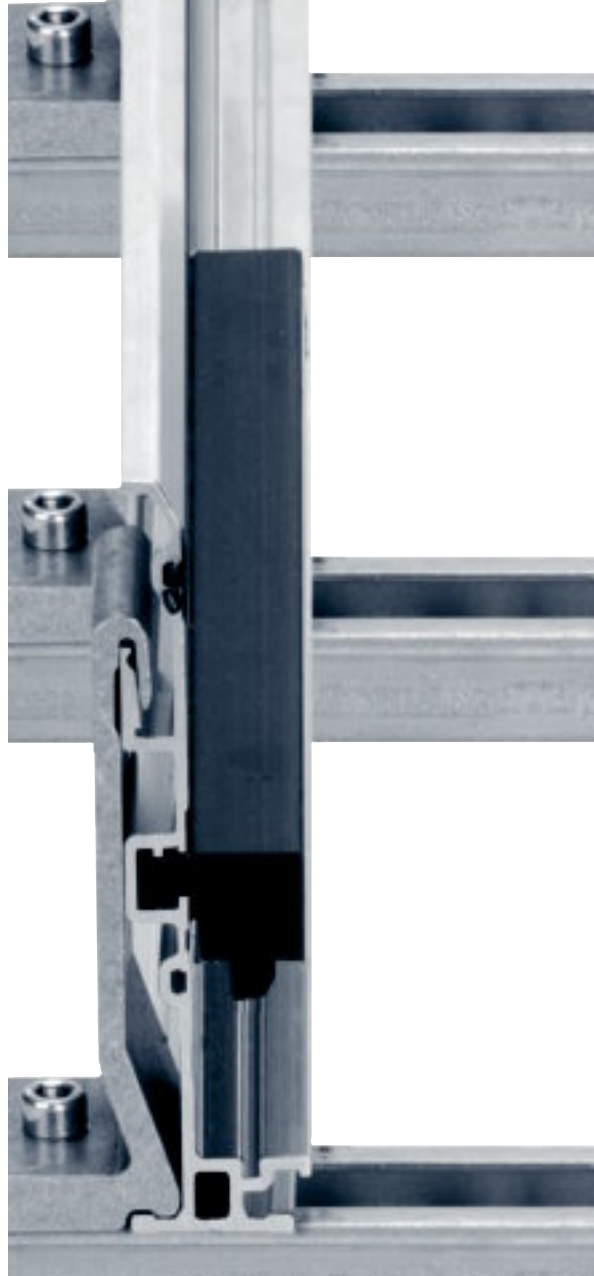

Super-aluminium guide trough. The igus® standard aluminium guide trough in two designs - lightning fast assembly ► page 9.1



Find a video online

► www.igus.de/SALU_Film

essories.

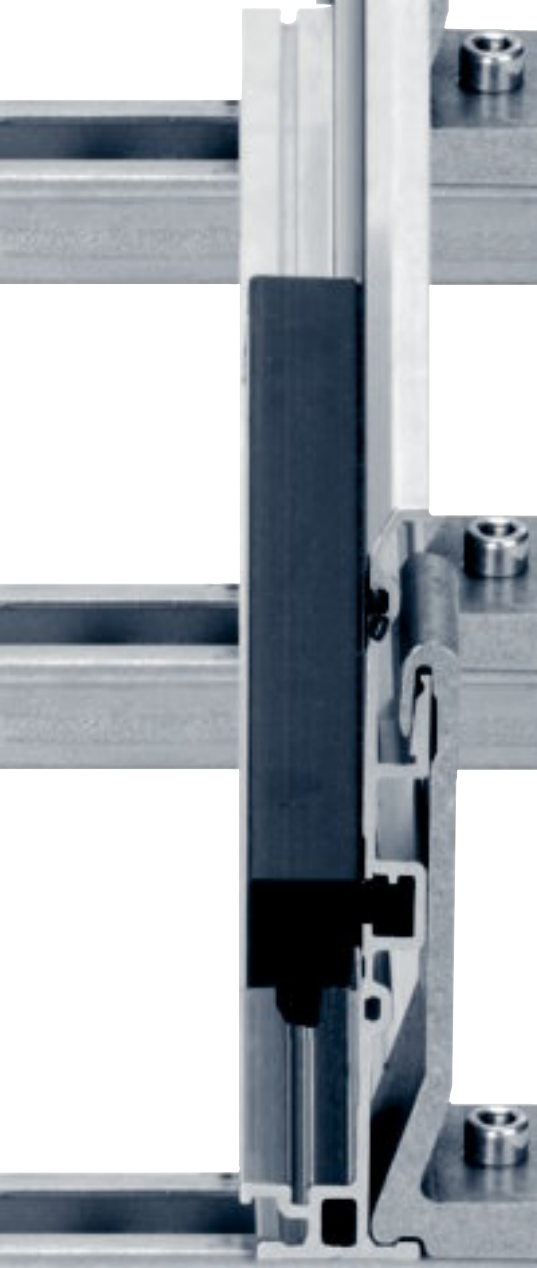

Tiewrap plates for cable strain relief engage on the C-profile of a KMA mounting bracket. Quicker and more compact assembly ▶ page 10.9

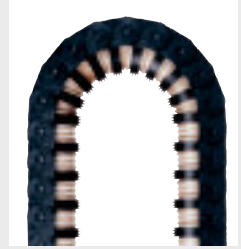

igus® developed extension links for a safe guidance of huge hoses in E-Chains® ▶ page 7.42 or 12.10



Special connecting elements with strain-relief for the Triflex® R E-Chain® (3D-robot) ▶ page 2.20



Chainfix cable strain-relief systems. Various systems for individual use ▶ page 10.4



TwisterChain® guide trough systems permit E-Chain® rotation as far as 520° ▶ page 2.70

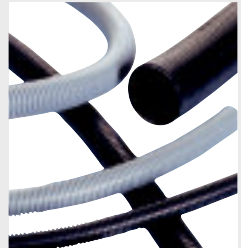

PMA protective hoses for predominantly static applications in E-Chains® and for protecting cables ▶ page 11.1

Chainflex®

Chainflex® lasts. Or your money back.

Your production processes must remain trouble-free, and that means your energy supply systems too. This requires fully reliable operation by all relevant components, including cables. igus® was the first company to develop complete E-ChainSystems®. Chainflex® cables and E-Chains® are offered together from a single source with a system guarantee depending on the application involved. Design principles based on knowledge of cables and exhaustive test Series since 1989 prevent machine downtimes at plants all over the world today.

7 rules for making a good cable

1. Strain-relieved core

Empty space arises at the core of the cable depending on the number and cross-section of the conductors. This core space should be filled to the greatest possible extent with a proper rope (not with the usual fillers or dummy wires made of waste material). This reliably braces the surrounding strands and prevents them from sliding into the middle of the cable.

2. Strands

Experience has shown that the strand structure should be as flexible as possible. Although very thin individual wires result in very flexible conductors, these are highly susceptible to damage. Extensive test Series have helped to determine which combination of wire diameter, strand pitch and strand direction optimizes bending resistance.

3. Core insulation

Insulating materials must be designed so that they do not stick together once inside the cable. Furthermore, the insulation should brace the individual wires of the cable. For this purpose, we use only the best PVC and TPE extruded at high pressure and proven in millions of kilometres of wire forming part of E-Chain® applications.





Conventional "chain suitable" cable (left) and igus® Chainflex® - special cable with 7 rules for a secure cable (right)

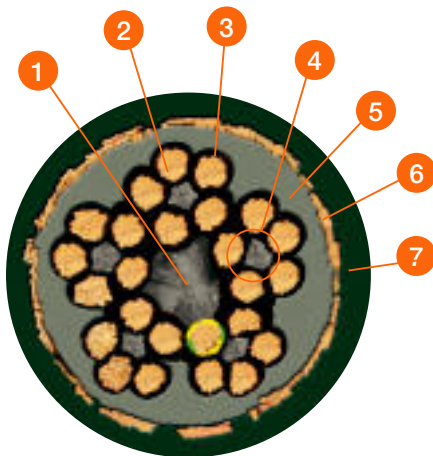

4. Braids

Braids must have an optimized, short pitch around a stable, strain-resistant core. To co-exist properly with the insulating materials, braids must allow movement over a certain range. Starting from a quantity of 12 cores stranding in bundles should be applied.

5. Inner jacket

A gusset-filling, extruded inner jacket should be used instead of low-cost non-woven fabric, filler or tracer. This permits secure longitudinal routing of the braid. It also prevents the braid from loosening and drifting.

6. Shielding

The shield should generally have a taut structure with an optimized angle of twist about an extruded inner jacket. Loose, open structures or, worse yet, purely circumferential windings notably reduce electromagnetic compatibility and can fail easily as a result of wire breakage. A taut shield braid makes the underlying wire braid more resistant to torsional strain.

7. Outer jacket

An external jacket made of ideal materials can meet a wide range of specifications: From UV resistance through low-temperature flexibility and oil resistance to cost-effectiveness. However, all external jackets should have the following in common: Highly resistant to abrasion without sticking and highly flexible while still supportive. In addition, all external jackets should be extruded at high pressure (gusset-filling).

QuickPin 2.0 - Online connector-cable-configurator ► page 12.47



Order separate Catalog online
► www.chainflex.eu or
phone +49- (0) 22 03-96 49-0

ReadyCr

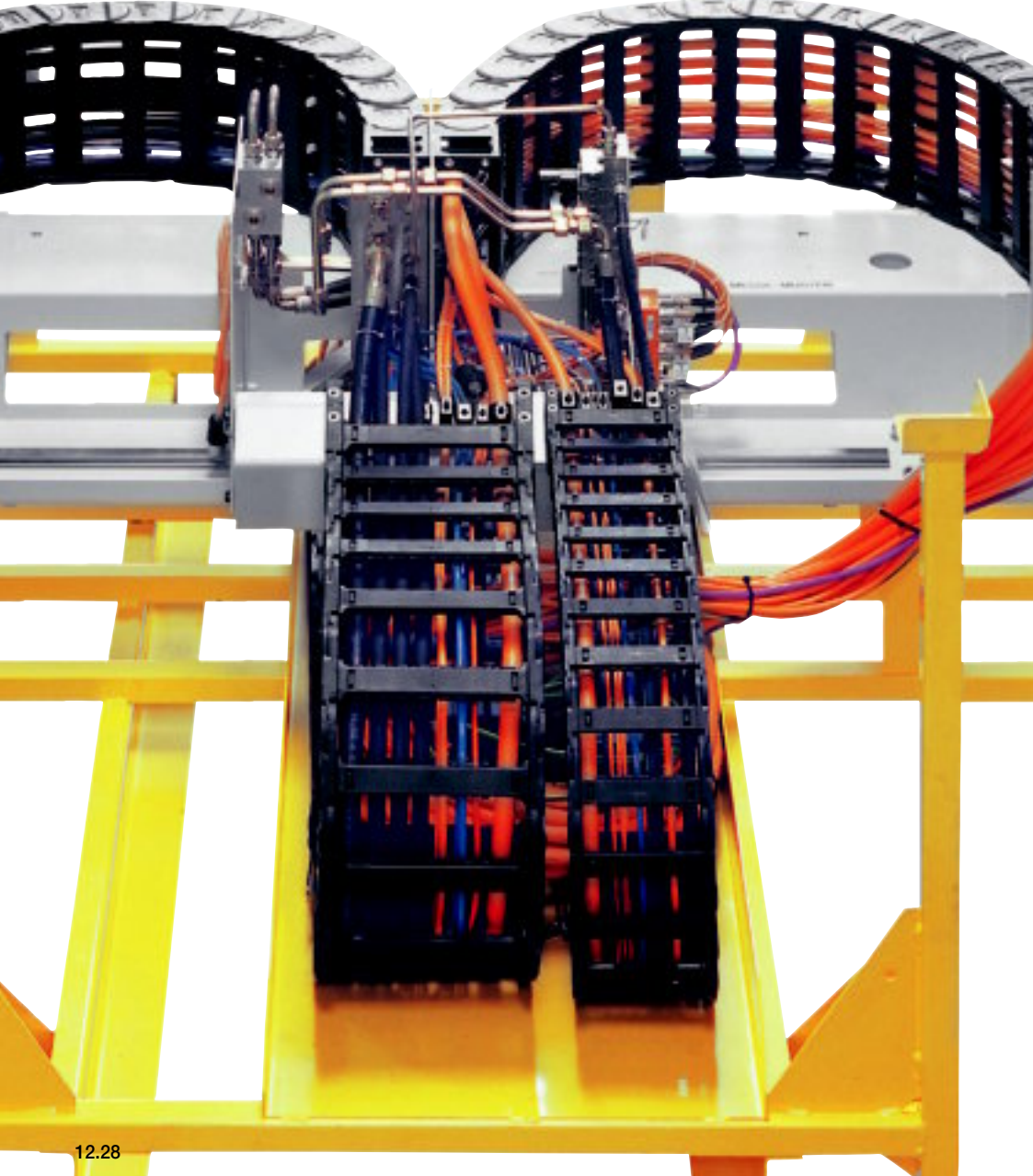

main.®

ReadyChain® harnessed E-Chain-Systems® are listed ► from page 1.41

Eliminate storage costs for cables, E-Chains® and plugs

Our short and guaranteed delivery periods enable you to dispense entirely with a storage of ultra-flexible cables, related plugs and add-ons.

Shorten turnaround times by half

Thanks to sophisticated logistics, igus® is able to supply complete systems within 10 days of the guaranteed deadline to almost any part of the world.

Flexible response to order fluctuations

With ReadyChains®, you remain prepared for all phases of an economic cycle. Fluctuations in your capacity utilization are absorbed by our product logistics.

Reduce the number of subcontractors and related orders by 75%

One order, one invoice, one delivery, one partner. You no longer need to procure countless individual components from a host of subcontractors; we know how to acquire the right parts quickly and economically.

Minimize your machine downtimes

External purchases of numerous individual components not only make your systems more susceptible to malfunction but also make trouble-shooting more difficult. ReadyChains® provide you with standardized systems. Every system is tested at our facility prior to delivery. igus® is certified according to ISO 9001.

www.ReadyChain.eu



Find a video online
► www.igus.de/RC_Film

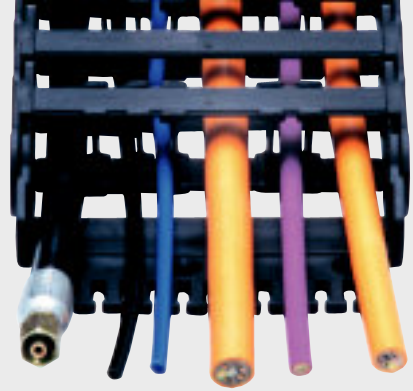

"Basic" ReadyChain®

Simple, harnessed E-ChainSystems® including installed cables without plug connections, labelled and tail-lengths according to your specifications.



Delivery time: 1-3 days

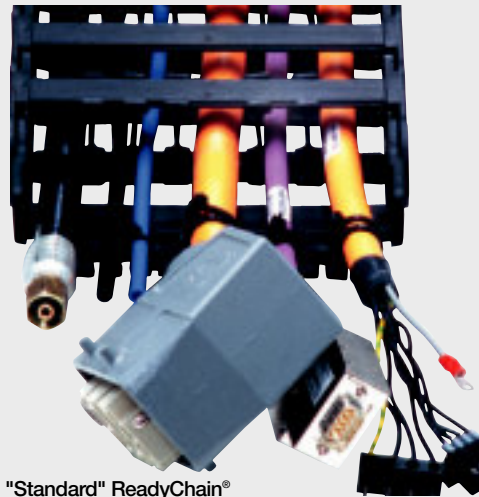

"Standard" ReadyChain®

Simple, harnessed E-ChainSystems® including installed cables with all plug connections, labelled and tail-lengths according to your specifications.



Delivery time: 3-7 days

Fig. left: "Premium" ReadyChain®

A harnessed E-ChainSystem® with cables of all kinds, as well as plugs, connectors, tail-lengths and components according to your specifications. Special shafts and plain bearings machined according to your specifications.



Delivery time: 3-10 days

igus®.qua

Quality from the igus® laboratory: Tested and proven every day.

Applications involving high cycle counts, speeds and accelerations or demanding environmental conditions require proven systems especially when it comes to E-Chains®, cables, polymer slide bearings and linear systems. igus® regularly conducts tests at its own laboratory under realistic conditions. Every year, we conduct more than 2,000 tests on E-Chains® and cables, and over 5,000 tests on plain bearings. These tests focus on push/pull forces, friction values, wear rates, drive forces and abrasion under all possible conditions at diverse speeds. Influential factors like soiling, weathering, cold and impact are examined. Tests are also performed on electric cables and hydraulic and pneumatic hoses. Our laboratory is at your disposal. Should we lack data for your application type, we will gladly conduct tests according to your requirements.



Find a video online

► www.igus.de/testlab

Global Warranty Certificate



igus® system warranty - Every application is different. igus® warranty certificates will be issued for your application individually. Ask for igus® warranty: **"chain, cable, guarantee!"**

Fig. center: Partial view, igus® test-lab: More than 80 tests every day with E-Chains® and Chainflex®-cables



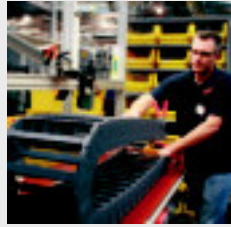

igus® ESD-tests
in the production line



Electronic check and archiving
for every chain production run



Cables are also tested
for torsion properties



Noise level test inside
an igus® acoustic cell



Push Pull forces speed up to 10
m/s, acceleration up to 200 m/s²
are tested by igus®



Long travel test field: 125 m
travel length, speed 300 m/min



All products are tested and available from a single source.
Examples of test certificates and quality seals for igus® products:

delivery.s



8 to 8 plus Saturday service

Over 80,000 products ex-stock! Order a 0.1 m of Chainflex® cable, just one chain link or two bearings without surcharges. Invoices and acknowledgements available by post, fax or e-mail. There are 1,800 employees in Germany and 26 international subsidiaries and offices, plus bases in another 31 countries to guarantee a rapid delivery worldwide.

- Delivery and consultation daily from 8 am to 8 pm, Saturday from 8 am to 12 pm
- No minimum order values
- No surcharges
- Order tracking on the Internet right up to the point of delivery
- Simple returns procedure

i-net customer information system

At: www.igus.eu track your orders in real time with igus® i-net. Just request a password, log into i-net and track your jobstatus via a webcam. igus® i-net shipment tracking permits a monitoring of deliveries from igus® outlet right up to your doorstep.

- Detailed order data including an overview of target and actual deadlines
- Order confirmation via post, fax or e-mail as required
- Track your orders via webcam

igus® delivery service -

No minimum order quantities, no surcharges.

► www.igus.de/en/deliveryservice

Request order tracking
here: www.igus.de/en/i-net

service.

24 h
or today

24-48 h

24-72 h

3-10 days

Individual components

For instance:
One E-Chain® link,
6 m of E-Chain®,
3 strain-relief elements

Customized E-ChainSystems®

For instance:
11.46 m of E-Chains® with interior separators, mounting brackets and strain relief elements according to your specifications. Additional with loose accessories as Chainflex®-cables, guiding troughs, mounting brackets, strain reliefs and assembly parts

Simple pre-fabricated systems

"Basic" ReadyChain®:
Simple customized E-ChainSystems® including installed cables with-out plug connections, labeled and tail-lengths according to your specifications

Complex pre-fabricated systems

Premium ReadyChain®:
Complex customized E-ChainSystem® including cables as well as plug connections, mounting brackets, tail-lengths and components according to your specifications.

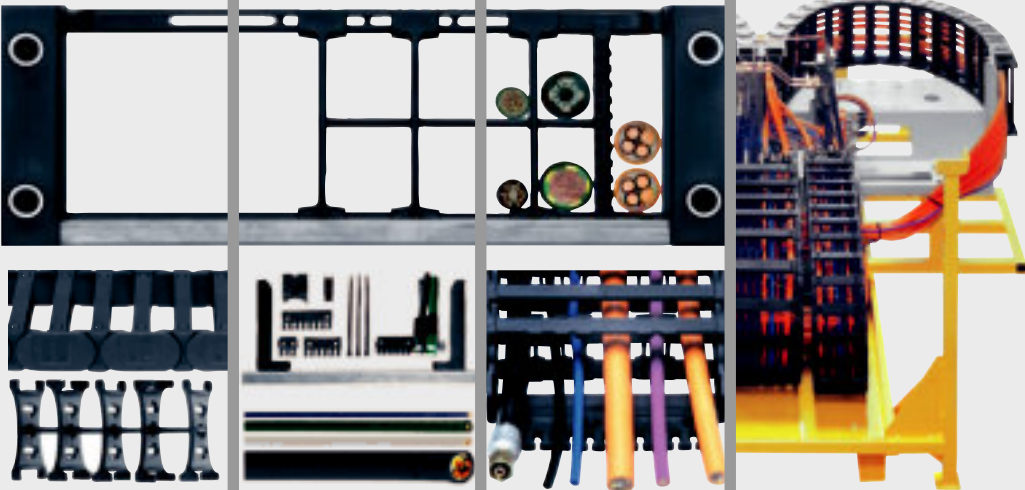

igus®.1964

Innovation with plastics

The igus® story begins on October 15th, 1964 with Günter Blase in a double garage in Cologne-Mülheim. In its first 20 years, igus® operated as a supplier of intricate technical plastic components. In 1983, son Frank Blase started to concentrate on full products like E-ChainSystems® and Polymer Bearings and established a separate marketing department. Between 1985 and 2009, igus® expanded from 40 over 1800 staff members distributed all over the world. igus® will continue to invest in expansion in the coming years. Modern materials have opened up further opportunities for innovative products



igus® Sales & Marketing, from left.: Tobias Vogel, Sales Manager Polymer Bearings, Harald Nehring, authorized signatory, E-ChainSystem® & Chainflex®, Gerhard Baus, authorized signatory Polymer Plain Bearings, Michael Bläß, SalesManager E-ChainSystem® & Chainflex®, Frank Blase, CEO.



Today: Automated plastic production

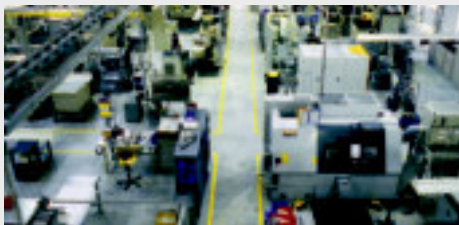

Today: Large tool development and production facility

12.34

1965
First iglidur®
sliding element:
Plug valve for
the company
Pierburg



1971
First E-Chain®
Series 20



1979
First E-Chain®
catalog of
2 pages

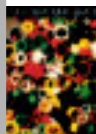

'65 '70 '75 '80



Company founders Günter and Margret Blase in front of their "double garage" from 1964

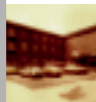

1977: Relocation to the Locher Mühle in Bergisch Gladbach





















5

10

27

1.000

4-2009.

<p>1979 First E-Chain® catalog of 2 pages</p> 	<p>1991 xigus 1.0 electronic catalog</p> 	<p>1995 ReadyChain®, with the slogan "Chain-Cable Guarantee"</p> 	<p>2001 System E6 E-Chains®</p> 	<p>2003 Trifflex® R</p> 	<p>2005 iglidur® PRT- slewing bearing</p> 	<p>2007 System E4.1 E-Chain®</p> 	<p>2008 E4.350 largest polymer E-Chain®</p> 	<p>2009 E4.1- New Interior separation tool box</p> 
<p>1989 E4 E-Tubes, to open on both sides</p> 	<p>1993 Introduction of DryLin® R</p> 	<p>1997 DryLin® T</p> 	<p>2001 DryLin® N</p> 	<p>2003 DryLin® W</p> 	<p>2006 LeviChain</p> 	<p>2007 DryLin® ZLW</p> 	<p>2008 xiros® polymer ball bearings</p> 	<p>2009 FX40 - Totally new E-Tube with chip repellent design</p> 
	<p>1994 Introduction of igubal®</p> 				<p>2006 System P4 roller E-Chain®</p> 			<p>Guidelok horizontal - Guidance of the upper run for long travels</p> 

'85 '90 '95 '00 '05 '06 '07 '08 '09

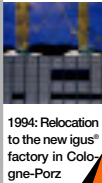
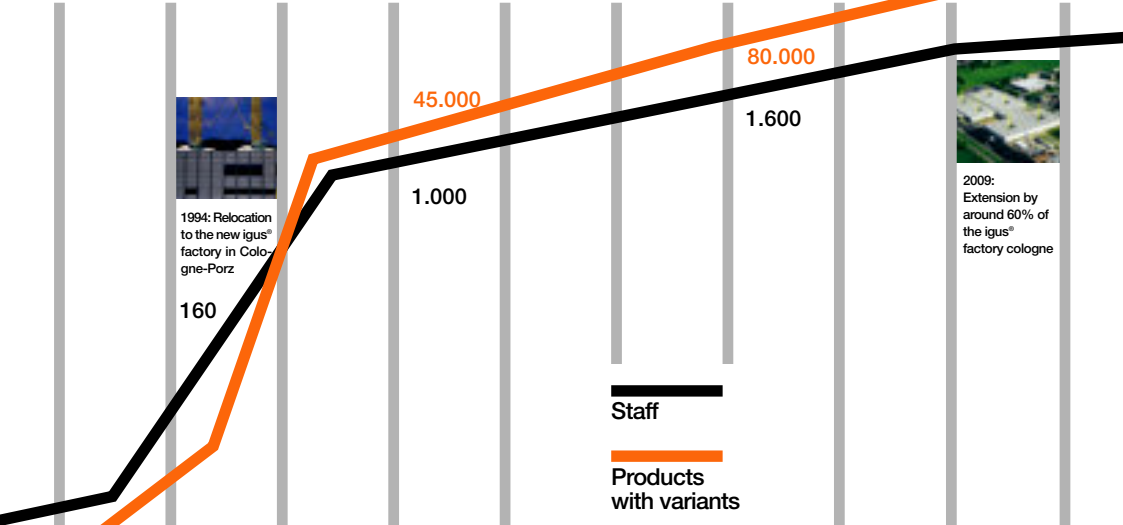

1994: Relocation to the new igus factory in Cologne-Porz

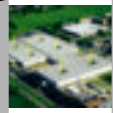

2009: Extension by around 60% of the igus factory cologne

Staff
Products with variants

igus[®].factory



The environment at igus[®] is fully open - anyone can contact anyone else directly, everyone works at identical desks, has the same work equipment, the same choice of meals at the cafeteria and the same bathroom facilities.

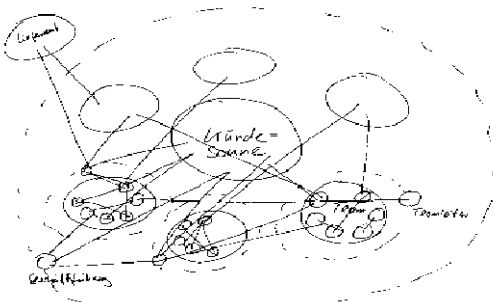

For us, customers have the same significance as the sun to life on earth. The sun gives light, warmth and energy - our customers give us ideas, work and money.

Factory enlarged by 60 percent and all departments closely examined igus[®] is now producing, testing and researching in Cologne on a floor area covering 36,000 m². The factory area has been extended to 29,000 m², added to which are 7,000 m² of surrounding buildings for additional fabrication, technical training and a large logistics center. In the course of the factory extension, together with consistent lean management we have closely examined all departments: from marketing and administration to research and development, tool design and production through to warehousing and distribution. ► www.igus.eu/2009

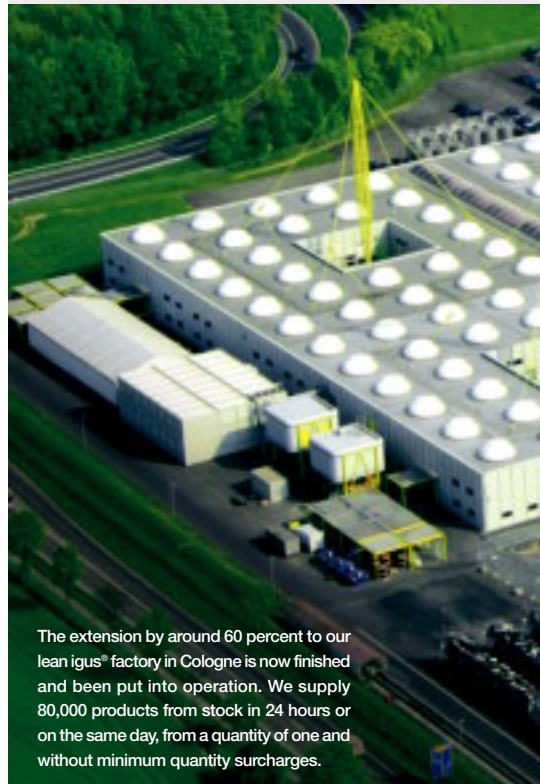

The extension by around 60 percent to our lean igus[®] factory in Cologne is now finished and been put into operation. We supply 80,000 products from stock in 24 hours or on the same day, from a quantity of one and without minimum quantity surcharges.



Find a video online
► www.igus.de/igus_Film

only.

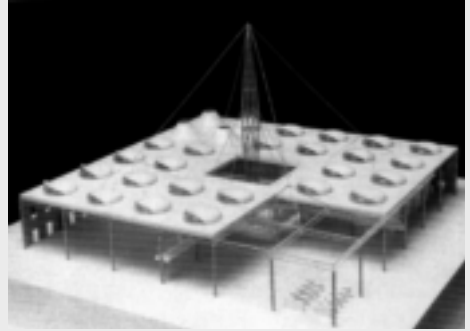
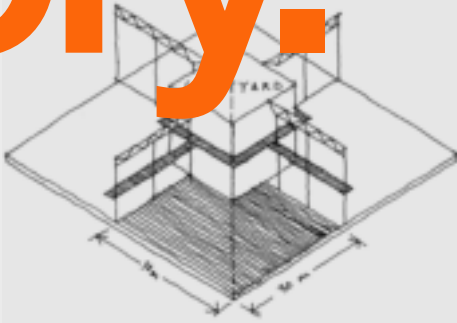

Excerpt of architect's briefing...

"In October 1988, igus® acquired a plot sized about 40,000 m² in the Porz-Lind district of Cologne. This will be the future site of development, production, sales, administration and planning. As the centre of all activities, this location will serve as the new igus® headquarters. igus® has made preparations for fast growth, fast change and flexible response in all areas... Offering the necessary facilities and technology, the new "igus® premises" will also be designed to promote staff performance. The

interior and exterior will be designed to reflect the enterprise's products and key philosophy: innovation - service - reliability, the customer being comparable to a solar system's centre orbited by all igus® staff and igus® entities dedicated toward solving the customer's problems."



the.catalog

Price index

The price index allows comparisons with similar E-Chains® of the igus® program

Series Overview

Opening principle of the selected E-Chain®

Certifications

Available certifications and approvals for the E-Chain®

Product illustration

Description of the E-Chain®, design structure and detailed product information

Opening principle

How to open and close the E-Chain® and other assembly tips

Performance test

Advantages and recommendations regarding this igus® product

Long travels

Important details for configuring and calculating chain length for long travels

Order example for a complete E-ChainSystem®

igus® The robust E4.1 | Series E4.56

Price index
Series E4.56 Series E4.56 Series E4.56

Low noise version
available with special roller guide design

CleanRoom
clean room ready upon request

ESD classification
Electrically conductive ESDE4.56

- 1 Straight run-through inner roller link design
- 2 Low noise operation through integrated rollers in the roller strip (ring system)
- 3 By the inherent design, very high-differing and ramping capability when these forces are at work
- 4 50% more tensile strength compared to the best all-steel series (better shockproofing through impact)
- 5 Rip-free bottom and without side flaps
- 6 Crawler available for fiber (available also as fiber separator kit)
- 7 New roller separator kit available
- 8 "flexion" feature for turning (turning roller strip without track possible)

When to use the Series E4.56 (E4.56):

- If a low noise version is required
- For very high speeds and/or accelerations
- For long travels
- For high additional loads

When not to use it:

- When an extremely low vibration E-Chain® (E-Tube) is required

Order example complete E-Chain®
Please indicate chain length or number of links. Example: 3 m or 33 links

3 m E4.56.33.300.0 **E-Chain®**

with 2 separators 411 assembled every 2" link **Interior separation**

1 set E4.560.36.1.12.C **Mounting bracket**

7.60 **Available from stock. Delivery in 24h or today!** (Delivery time means time until shipping of goods)

Calculation aid

Important details for configuring and calculating chain length as well as installation space

Unsupported length

Diagram of unsupported length for the selected E-Chain®

Series
Quickly find the requested Series

Inner height
At a glance: Inner height and opening principle for each Series

Chapter color
Every E-Chain® Series has a distinct chapter color permitting faster browsing

Product range

Interior separators

Mounting brackets

Strain relief elements

Guide troughs

Assembly instructions

E4.11 Series E4.56 | Installation Dimensions and Technical Data

Unsupported length

P_{L1} = with height upper run

P_{L2} = with limited top

Further information ► Design, page 1.12

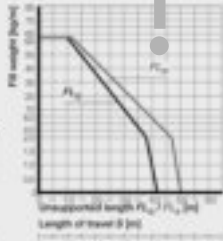

- S = Length of travel
- R = Bending radius
- M = Required clearance height
- H_0 = Required clearance height
- H_1 = Trough inner height
- D = Clear height "E-Chain" radius in this position
- K = $s + 4 \cdot R$ "Safety"
- D_1 = Clear height - long travel, gliding
- K_1 = Further add on
- H_2 = Mounting height

Other installation methods

- Vertical hanging = 100 mm
- Vertical standing = 6 mm
- Disassembled chains = 2.0 m
- Notes: require further calculation
- Unsupported length of upper run = open required



Short travels - unsupported

Unsupported E-Chain® feature position center over shaft teeth. This must be accounted for when specifying the clearance height H_0 . Please consult iguflex.com in particularly restricted.

The required clearance height

$H_0 = M + M$ mm with 3.0 kg/m @ weight



Pitch = 91 mm/Link Links/m = 11 (1001 mm) Chain length = $\frac{S}{P} + K$

S	100	150	215	285	345	395	455	495	555	605
P_{L1}	304	359	434	494	555	594	654	704	764	804
P_{L2}	288	343	418	478	539	578	638	688	748	788
K	910	860	736	612	642	512	1125	1285	1445	1505
H_0	324	379	454	514	575	594	654	704	764	804
D_1	288	343	418	478	539	578	638	688	748	788
K_1	910	810	686	562	532	402	2275	2545	2812	3078

Long travel lengths from 10 m to max. 400 m



In case of travels between 4 and 10 m we recommend a longer unsupported length.

Gliding, long travel applications (max. 400 m)

Follow the E-Chain upper run with the following guide trough or the lower run. We recommend to make the engineering of such a part by our technicians.

Speed / acceleration V_{max}	max. 20 [m/s] / max. 200 [m/s²]
Speed / acceleration V_{min} <td>max. 20 [m/s] / max. 8 [m/s²]</td>	max. 20 [m/s] / max. 8 [m/s²]
Gliding speed / acceleration (maximum) <td>max. 10 [m/s] / max. 10 [m/s²]</td>	max. 10 [m/s] / max. 10 [m/s²]
Maximal permitted temperature °C	90 [m/s] / 407 [m/s] = 130° C
Flammability class (per EN 50265)	UL94 V-0 (UL94 V-0, UL94 V-0)

Technical Data

Details of material properties
► page 1.38

For support of the lower run - Support Tray tool kit available ► page 5.70

iguflex.com

System E4.1 Inner height: 56 mm

Phone +49- (0) 22 03-96 40-800 Fax +49- (0) 22 03-96 40-222

7.63

QuickLin

igus plastics for longer life®

Products Services Shopping basket (0) Company Press

Home » E-ChainSystem® » Product overview » Energy Chain® E2000 medium » Series 2400

Series 2400

Here you can configure your E-ChainSystem® individually. All entries and changes are taking over to the part list which is situated at the end of the page.

Series 2400 - snap-open along inner radius

1. Tried-and-tested firmly-locked mounting bracket
2. Opening system for rapid opening
3. Semi-enclosed Energy Tube Series 2450
4. Series 2400 and 2450 snap-open along inner radius
5. Integrated strain relief possible
6. Lateral glide surfaces
7. Double stop dog

Inner widths B: 25 up to 125 mm
Bending radii R: 55 up to 250 mm
Pitch: 45 mm per link = 22 links/m

When to use Series 2400

- Operable at the inner radius
- Integrated strain relief is required in the connection area
- Variable interior separation
- Long service life
- Easy assembly

When not to use Series 2400

- When maximum stability is required
 - ▶ Systems E4 Series 226, etc.
- When to use the chip guard
 - ▶ Energy tubes E2, Series R48
- For very simple applications
 - ▶ Easy Chain®, E 200

Price index:

Opening mechanism:

Personal contact
igus® (UK) Ltd
51 Carwell Road
Bracknell
Northampton
NN4 7PV

Fax: +44(0)1604 677242
▶ igus®-contact
T: +44 (0) 1604-677240
▶ Send e-mail to igus®

▶ Application examples:
▶ 3D-CAD
▶ Samples, catalog and CD-ROM order
▶ E-Chain® comparison
▶ E-Chain® product finder
▶ PDF file
▶ Ask the product expert

7 widths and 9 bending radii

QuickLink - E-Chains® on the Internet! Go online and make use of all advantages at www.igus.de For every product in this catalog, there is a special QuickLink or direct online pointer to further useful details, data and facts. These include:

- Application videos and pictures
- Assembly instructions
- 3D-CAD files
- DXF data
- Comparisons and selection aids
- Online configuration tools
- Online wizard for calculations of service life
- PDF-data and other formats for download: ePlanDownload
- Personal support
- Catalog, CD and sample ordering forms

Example:
www.igus.de/en/2400

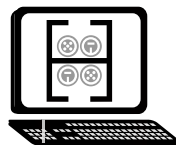

Create your complete E-Chain® with cables. A complete E-ChainSystem® at few mouse clicks
▶ www.igus.de/en/konfigurator



"Search" - E-Chain® product finder
Find the right E-Chain® quickly and easily by entering known application data and other parameters.

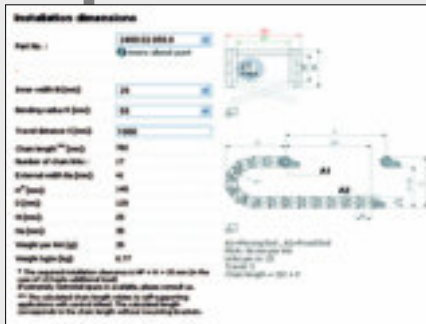

"Calculate chain length" E-Chain® length calculation.
Calculate the chain length and see all installation heights

"Configure" E-Chain® interior separator configuration
Quickly and easily determine interior separation for the selected chain via Drag & Drop. The configuration can be transferred automatically to your part list.
More details ► page 12.42

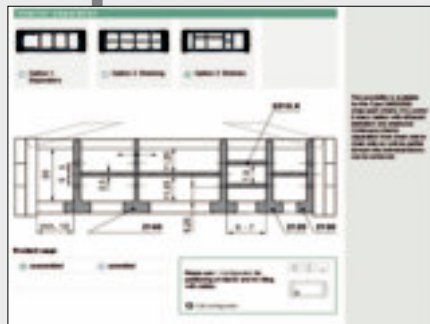

"Generate 3D file" E-Chain® CAD library
Download and save CAD data free of charge without having to register. Data on all products are updated and extended on a regular basis - nearly 30 3-D and 2-D formats are available here

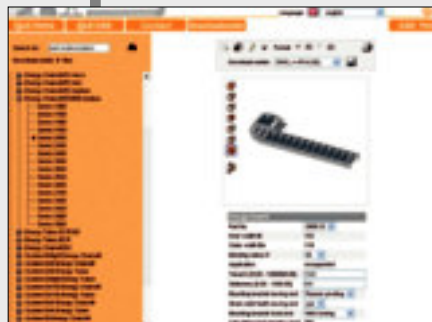

Take a tour ► www.igus.eu

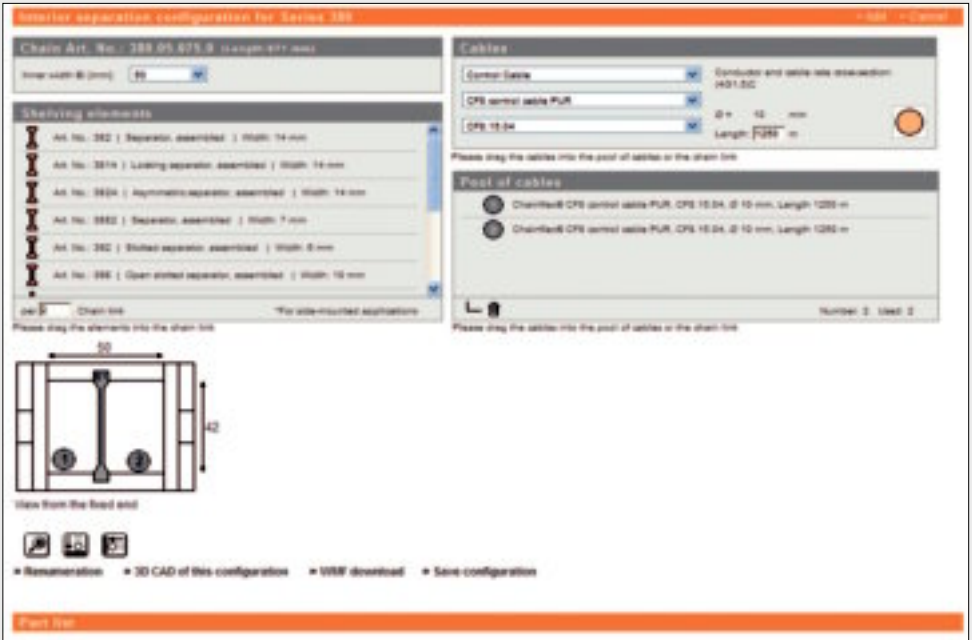

Change of the chain width directly in the configurator - Cable overview for better handling

igus® online configurator for interior separation!

Quickly and accurate to the right E-Chain® and Chainflex® cable combination

With the interior shelving configurator you design the complete filling of an E-Chain® easily and quickly and generate a 3D-CAD-file with one click.

- Interior shelving configuration now with logical check of min. bending radius.
- No manual calculation and crosscheck of the Chainflex® cable diameter and E-Chain® cross section necessary
- Now with cable overview for better handling
- Change of the chain width - now possible also in the inner shelving configurator
- Download E-Chain® partlist with interior shelving and cables in Excel format

www.igus.eu/iaconfigurator

nfigurator

Quick & Easy - QuickPin 2.0 Pin-Out Configurator

In only 3 minutes you choose out of 750 Chainflex® cables and 3,000 connector components, configure cables online, order directly and generate **ePLAN** electric P8 macro

- Quick and easy configuration and order of Chainflex® cables and connectors. Per mouse click and drag & drop
- Circular plug-in connector, squared plug-in connectors, sensor connector M8/M12, D-Sub and free cable ending possible
- Just a click to transfer the configured cable in the shopping basket and inquire, order or memorize for a later order
- Possibility to recall inquired cables from order history for new inquiries
- Online pricing, including copper charge
- Save design work: free of charge delivery of **ePLAN** electric P8 macro of the configured cable
- Harnessing from one source - 100 % tested
- Details of your personal contact person available on the spot
- No installation required
- In German and English
- Individual connector specification or components by manufacturers part numbers available

www.igus.eu/quickpin



Find a video online

▶ www.igus.de/quickpin-demo

ePLAN[®]
electric P8

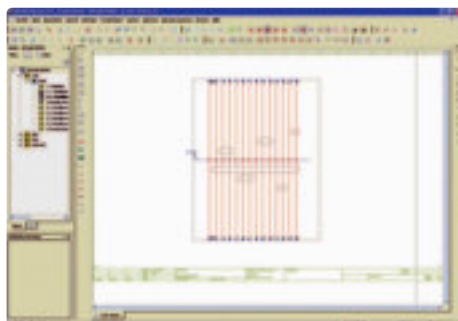

INTERCONTEC

FCT

HAERTING

IME

MARK

ITP

PHENIX CONTACT

xigus[®].



Our entire product range is also available on CD. The free electronic products "xigus" and "xiglidur" are more than just a product catalog on CD-Rom. They help with the selection of igus[®] products and offer many other features. Download ► www.igus.eu

xigus 7.1 - Simple design for your E-ChainSystem[®]

The user friendly interface allows "xigus" to configure your E-ChainSystems[®] quickly and easily, even providing a complete 3D file. Specific project data can be transferred directly. With just a few clicks you can enter data on length of travel, speed and acceleration. In the next step, the details concerning the cables are collected. You can add igus[®] Chainflex[®] cables with a mouse click, while hoses and other cables can be drawn up quickly. Parameters such as temperature, chemicals or contaminants are also input options, so you can determine exactly the right igus[®] E-Chain[®] range for your application.

- Quick, easy configuration of E-ChainSystems[®], all the way to 3D file generation
- Clearer product catalog for E-Chains[®] and Chainflex[®] cables, with all information on one page
- Direct takeover of individual project data
- 87 different 3D and 55 different 2D file formats
- Program range of more than 70.000 items
- Entire bills of material can be placed into the shopping cart
- No installation required
- Free of charge and available in six languages

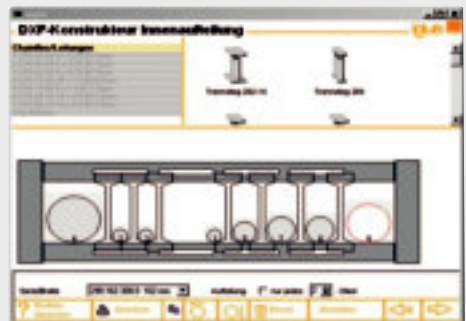

igus[®] applications.

Many interesting applications with igus[®] E-ChainSystems[®] ► from page 12.46

Legal information: The information in this catalog, and the data in the Design section in particular, is based on our current knowledge of the products described. No legally binding assurance in respect of characteristics or suitability for a specific intended application can be derived from it. igus[®] is unable to assume liability of any nature for damage, loss or injury resulting from application of the products. We recommend that you always check suitability of the products for a specific intended application in a practically oriented test. Please consult igus[®]. For reasons relating to ongoing technical developments, we reserve the right to implement technical modifications and improvement of the products at any time. All catalog dimensions and values apply only to standard material igumid G.

Subject to printing errors. The terms "igus", "ReadyChain", "ReadyCable", "Chainflex", "E-Chain", "E-ChainSystem", "EnergyChain", "Energy Chain System", "E-Ketten", "E-KettenSysteme", "Flizz", "Easy Chain", "Triflex", "TwisterChain", "Flizz", "igubal", "iglidur", "DryLin", "xiros", "invis", "vector", "ReadyCable", "manus" and "plastics for longer life" are legally protected trademarks for igus[®] GmbH/Cologne in the Federal Republic of Germany and, where applicable, in some foreign countries.

applicatio

long strokes

igus® E-ChainSystems® guide and protect moving cables and hoses on automated equipment. They can be used in a wide variety of applications, some examples following. More exciting examples ► www.igus.de/en/EKPraxis



Find a video online

► <http://www.vector-award.eu>



ons.



System E6, side mounted, in high-speed camera positioning system - high speeds and less vibrations



Long travel length with the super-alu-trough in a cold store



igus® steel guide trough used in a shelf conveyor application, series 350 and Chainflex® cables



Stable guidance without oscillation. Crane operating speed 80 m/min.



igus® E-Chains® 4040RHD "Rol E-Chain®" in an igus® super-alu-trough = 75% less driving power



Travel up to 195 m with the igus® System E4, safe guided in an igus® steel trough

Fig. left: The worldwide longest travel of 615 m with igus® Rol E-Chains® and Chainflex®-cables in a power plant

applicatio

machine tools



ons.



Series E4.42 in a machine tool, completely assembled with igus® Chainflex® cables



ReadyChain® with combined motions on tooling machines. Turnkey delivered with special parts for your machines



E2/000 dirt-insensitive E-Chain®, which saves installation space - here Machine tool for workpieces



Machine tool gantry with various E4 E-Chains® - fast movements and high cycle counts



E4 E-Chain® was used here in curved sections with a 45 m travel distance



Short travel lengths and high accelerations with Series E2 mini

Fig. left: Portal milling machine with fully closed E4 E-Tube with special material igumid HT. 850°C hot chips - no problem

applicatio

cranes & offshore

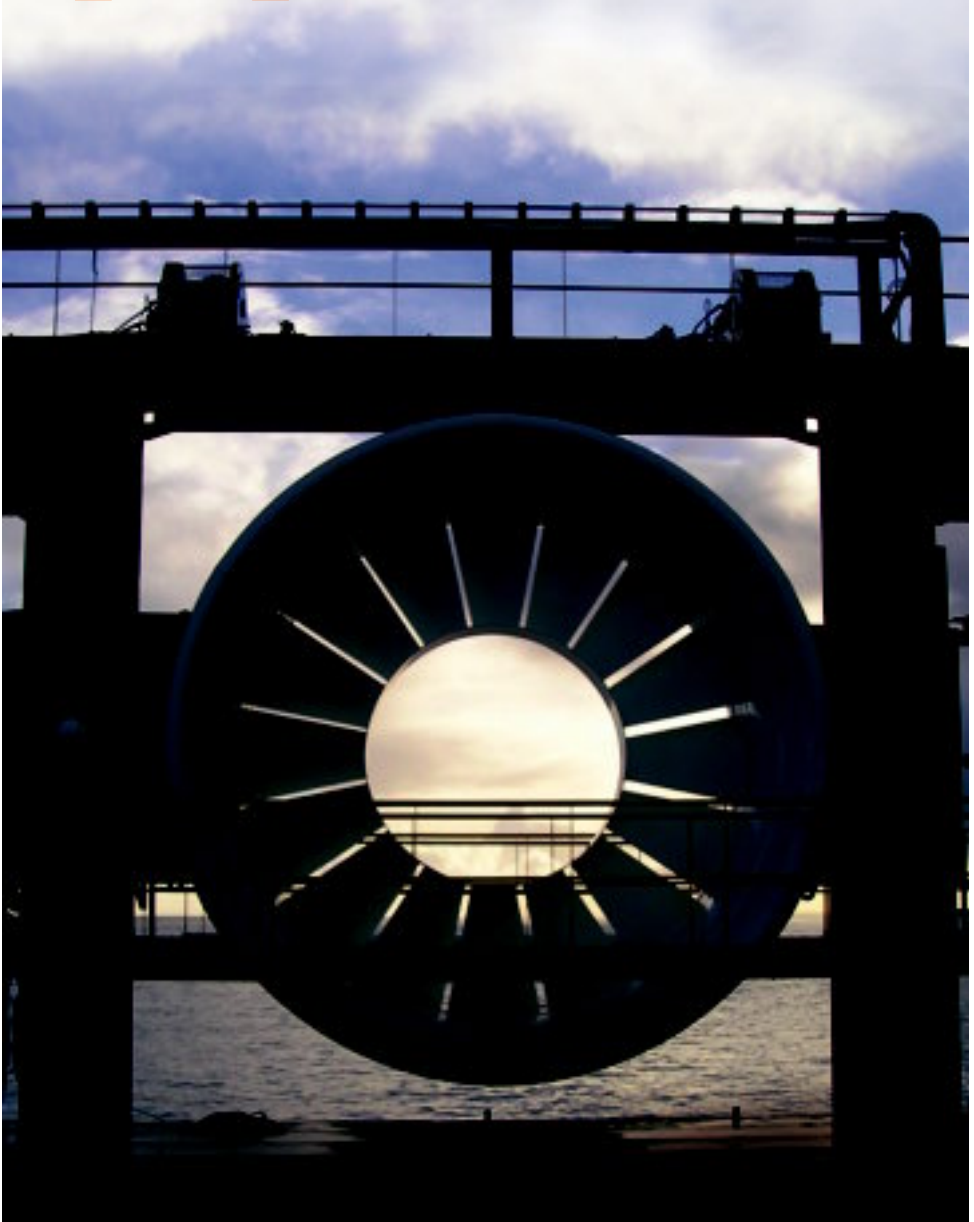

ons.



Seawater resistant super-alu-trough in a RTG-crane. Long travel with the E4/4 system



igus® steel guide trough used in a robotics application



E4 as ZigZag version in a crane. The E4-Series guarantee very high availability of the facility



System E4 with extension link at a ship loader for the coal unloading Travel 105 m, speed 240 m/min, load 53 kg/m



Standing application with System E4 and fixed mounting brackets



E-Chain® at the mast of the shelf conveyor rolls from one aluminum guide trough to the opposite one

Fig. left: OpenHydro tidal turbine generates electric power through the inflow and outflow of water at low and high tide. Serie 4040 protects the deployed Chainflex® cables during the lifting and lowering movements of the turbine and also protects them against aggressive ambient conditions. The travel distance amounts to approx. 20 metres in vertical direction above and under water with the robust E-Chain® guided in a steel trough. The vertical travel is transformed into a horizontal stroke by turning through 90 degrees.

application

high speed & smooth running



ons.



System E6 in a pick and place robot.
Handles injection molded CD covers in a split second



Serie E6 accelerates the work sequences in the case of this application for wafer handling. $a = 4 \text{ m/s}^2$, $v = 6 \text{ m/s}$



igus® Series E3.15 side
mounted in a flat-bed scanner

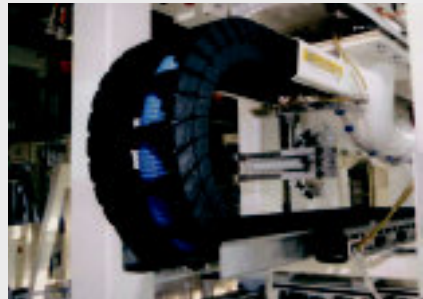

igus® System E6 - High
acceleration (8g) and ESD safety



Nested E-Chains® reduce vibrations
and improve milling accuracy Series E6.62



igus® System E6 harnessed in a printing machine.
Clear separation due to the igus® separator-program

Fig. left: Low-noise low vibrations with E6.
Designed to withstand high dynamic loads

applicatio

circular & 3D movements

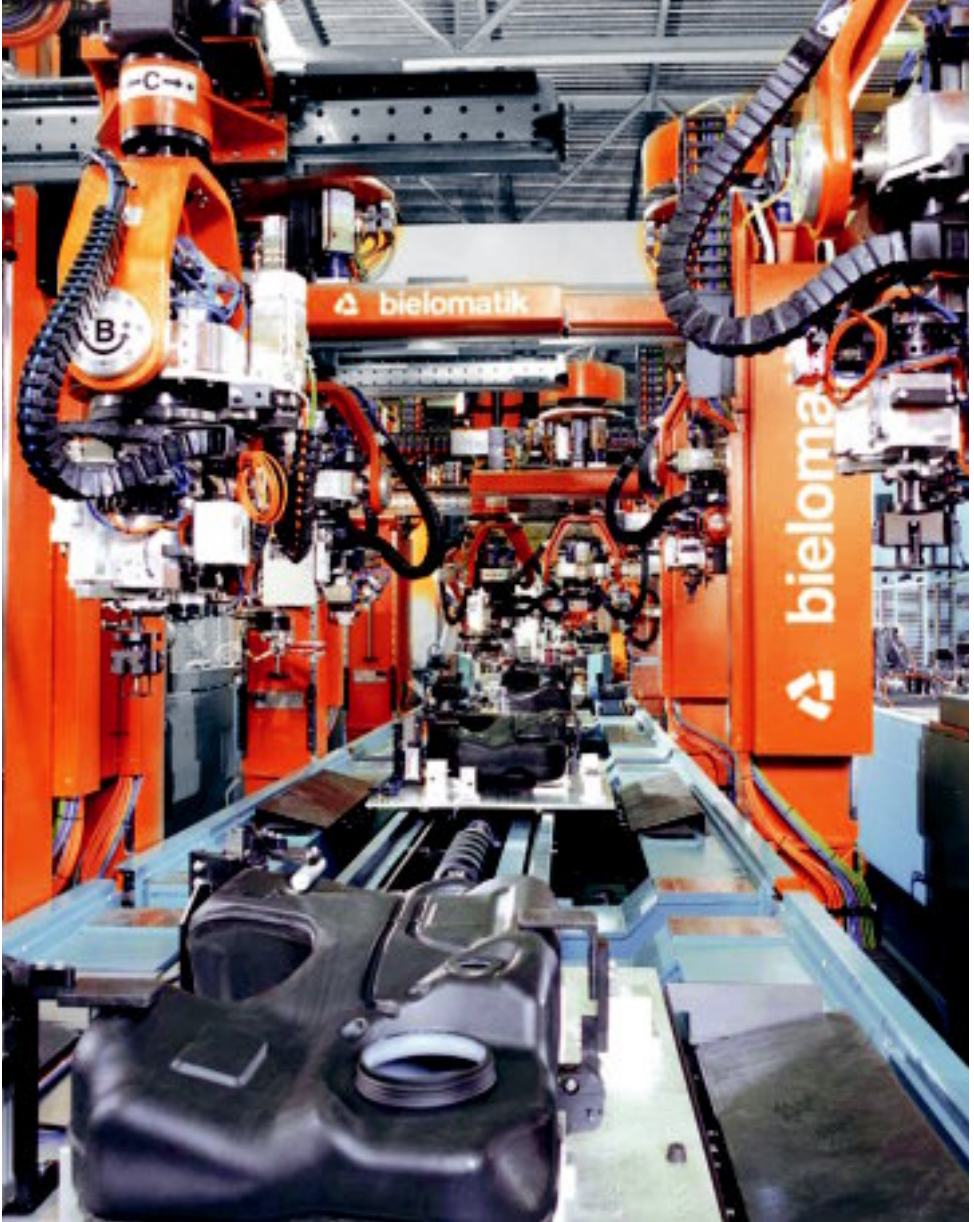

ons.



E4 RB² application in a telescope - cold temperatures and snow - failsafe!



Laser measuring telescope with Triflex[®] R. Rotary motion in both directions $\leq 30^\circ$. Also possible at high speeds ≤ 20 m/s

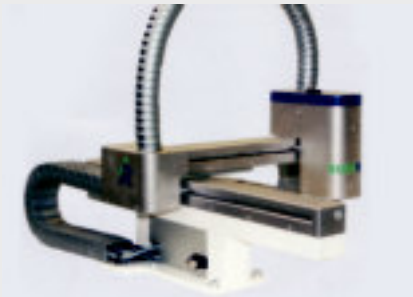

3-axis robot for loading and unloading functions with Series R48 and easy to fill igus[®] E-Chain[®] Triflex[®] R (TRE)

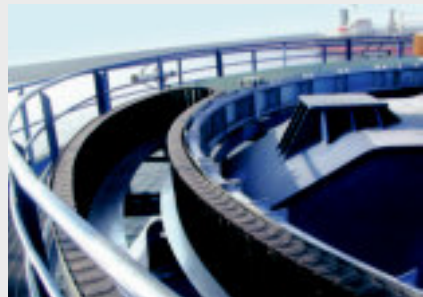

Circular movement with Series E4/4 - safe energy supply on cranes



Triflex[®] R in a magnesium die-casting industry (heat, dirt, oil, metal chips, dust, etc.)- failsafe

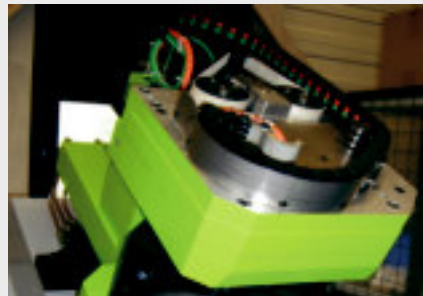

E2 mini, Series E5 - The motor spindle has swivelling range of approx. 210°

Fig. left: Easy Triflex[®] E-Chains[®] for multi-dimensional movements on a production line

applicatio



ons.



Two fully harnessed E2/000 E-Chains® with high fill weight, side mounted



Unsupported application with harnessed E-Chain® System E4



E2/000 - high stability in this elevator with an height of 160 m



Series R68 works in an apple-sorting-machine: humidity and dirt



Standing application with System E4 and fixed mounting brackets

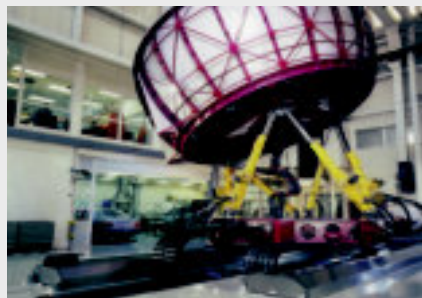

Drive simulator. High fill weights (60 kg/m) with E4 System

Fig. left: Data gloves with Easy Chain® Series E03 - Protect the sensors which makes it easier to take off an put on the gloves. Inner height of 5 mm



Fax-Forms



igus[®] Addresses



Date:	Phone: +49- (0) 22 03 96 49 - 800 Fax: +49- (0) 22 03 96 49 - 222
From:	To: igus® GmbH Technical Sales Energy Chain Systems® P.O. Box 90 61 23 51147 Spicher Str. 1a
Phone:	
Fax:	

Fax-Forms

I would like to receive detailed information about the following products:

Printable media - catalogs for: Chainflex® special cables, Polymer Plain Bearings



- Over 850 Chainflex® cables for all applications
- Listed according to price categories
- Detailed description of cable assembly

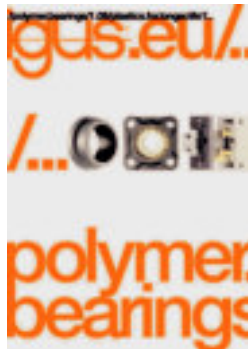

- All technical specifications of the igus® plain bearing product range
- Many application examples and calculation assistance
- More than 9,600 polymer bearing products in one catalog

Phone +49- (0) 22 03-96 49-800
Fax +49- (0) 22 03-96 49-222

Electronic media - CD-ROM: xigus, xiglidur, crane presentation:



- Quick, easy configuration of E-ChainSystems®, all the way to 3D file generation
- New, clearer product catalog for E-Chains® and Chainflex® cables, with all information on one page
- Direct takeover of individual project data
- 87 different 3D and 55 different 2D file formats
- Program range of more than 70.000 items
- Entire bills of material can be placed into the shopping cart
- No installation, no costs



- Using the information you give us, the iglidur®, igubal® and DryLin® expert systems calculate their functionality and life cycle for you
- The entire catalog for plain bearings available on CD
- DXF library
- Photos, drawings, applications, etc.

igus® GmbH
51147 Cologne

Internet: www.igus.eu
E-mail: info@igus.de

Date:	Phone: +49- (0) 22 03 96 49 - 800 Fax: +49- (0) 22 03 96 49 - 222
From:	To: igus® GmbH Technical Sales Energy Chain Systems® P.O. Box 90 61 23 51147 Spicher Str. 1a
Phone:	
Fax:	

Fax-Forms

Chain Type

Length

Cable/hose requirements:

Phone +49- (0) 22 03-96 49-800
Fax +49- (0) 22 03-96 49-222

Interior separation / Vertical separators
Cable/hose layout within carrier

igus® GmbH
51147 Cologne

Cable/Hose End 1	Connector End 1	Union 1	Cable/Hose End 2	Union 2	Connector End 2

Internet: www.igus.eu
E-mail: info@igus.de

Date: _____	Phone: +49- (0) 22 03 96 49 - 800 Fax: +49- (0) 22 03 96 49 - 222
From: _____ Phone: _____ Fax: _____	To: igus® GmbH Technical Sales Energy Chain Systems® P.O. Box 90 61 23 51147 Spicher Str. 1a

Type of Application
(check all that apply)

-
-
-
-
-
-
-
-

Installation Space

Travel S: _____ mm Fixed end:
 center of the travel yes
 or _____ mm from the center

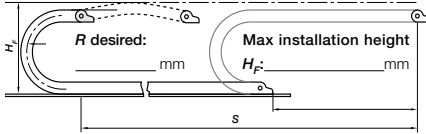

Assembly point (floor, wall, console, etc.): _____ mm

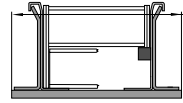

Max. width permitted
(if applicable): _____ mm

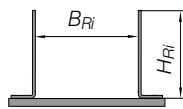

Guide trough?
 yes: if yes which
 Dimensions: B_{Ri} _____ mm
 Dimensions: H_{Ri} _____ mm

Span (standard = 2 m): _____ mm

Dynamics
Environment

Speed: _____ [m/s] Acceleration: _____ [m/s²]

Cycles/Day: _____ Days/Year: _____ Ø Outer diameter: _____

Temperature [°C]: _____ Humidity (%): _____ Dust, dirt, chips: _____

Special parameters: _____

Cables/Hoses

Number	Manufacturer/Type, No.	Conductor/AWG	Ø	Weight kg/m	Bending Radius

Further individual components desired:

- Energy Chains® / Energy Tubes
- Chainflex® cables/special conduits
- Guide trough
- Strain relief
- Harnessing
- On-site assembly
- Others
- Energy Chain®
- Energy Tube
- To be opened on both sides
- Along the outer radius
- Along the inner radius
- Special requests: _____

Date:	Phone: +49- (0) 22 03 96 49 - 800 Fax: +49- (0) 22 03 96 49 - 222
From:	To: igus® GmbH Technical Sales Energy Chain Systems® P.O. Box 90 61 23 51147 Spicher Str. 1a
Phone:	
Fax:	

Travel S: _____ mm Fixed end: center of the travel yes or _____ mm from the center

R desired: _____ mm **Max installation height H_F :** _____ mm

Assembly point (floor, wall, console, etc.): _____ mm Span (standard = 2 m): _____ mm

Max. width permitted (if applicable): _____ mm

Guide trough? yes: if yes which
Dimensions: B_{Ri} _____ mm
Dimensions: H_{Ri} _____ mm

Speed: _____ [m/s] **Acceleration:** _____ [m/s²]

Cycles/Day: _____ **Days/Year:** _____ **Ø Outer diameter:** _____

Temperature [°C]: _____ **Humidity (%):** _____ **Dust, dirt, chips:** _____

Special parameters: _____

Number	Manufacturer/Type, No.	Conductor/AWG	Ø	Weight kg/m	Bending Radius

Further individual components desired:

Energy Chains® / Energy Tubes	<input type="checkbox"/>	Energy Chain®	<input type="checkbox"/>
Chainflex® cables/special conduits	<input type="checkbox"/>	Energy Tube	<input type="checkbox"/>
Guide trough	<input type="checkbox"/>	To be opened on both sides	<input type="checkbox"/>
Strain relief	<input type="checkbox"/>	Along the outer radius	<input type="checkbox"/>
Harnessing	<input type="checkbox"/>	Along the inner radius	<input type="checkbox"/>
On-site assembly	<input type="checkbox"/>	Special requests: _____	<input type="checkbox"/>
Others	<input type="checkbox"/>	_____	<input type="checkbox"/>

Installation Space

Dynamics

Environment

Cables/Hoses

Type of Application (check all that apply)

	<input type="checkbox"/>
	<input type="checkbox"/>
	<input type="checkbox"/>
	<input type="checkbox"/>
	<input type="checkbox"/>
	<input type="checkbox"/>
	<input type="checkbox"/>
	<input type="checkbox"/>

A

Abbreviation 1.4

Abrasion resistance 1.34

Acceleration 1.4

- cross 1.20, 1.23
- for short travels 1.10

Additional load,

maximum 1.4, 1.24, 1.25 (graphic)

Applications:

- "interlocked" 1.4
- combined motion 1.4
- E-Chain System® 1.6 et seq.
- gliding 1.4
- hanging 1.4, 1.20 et seq.
- horizontal 1.4
- installation design "zigzag" 1.21
- pictograms 1.4
- ReadyChain® 1.41 et seqq.
- short travels 1.8 et seqq.
- side-mounted 1.4 et seq., 1.24 et seq.
- turned (90° C) 1.24 et seq.
- vertical hanging 1.4, 1.20 et seqq.
- vertical standing 1.4, 1.22 et seq.
- unsupported 1.8 et seqq.

Assembly 1.42

ATEX 1.35, 1.38

AUTO-GLIDE 9.90 et seq.

B

Ball indentation hardness 1.39

Bend (F_L) 1.4, 1.8 et seqq., 1.12 et seqq.

Bending radius, reversed 1.4, 1.26, 1.29

C

C profile 1.33

Cable 1.20, 1.22, 1.25, 1.28 et seqq.

Cable system 1.28 et seqq.

- bending radius R 1.29
- diameter 1.28
- general rules in E-Chains 1.28
- round 1.29
- separation 1.29

Calculation of the chain lengths 1.5

CE 1.38

CEI 1.38

Certificate 1.38

Chain: see E-Chain®

Chainfix 1.32 et seqq.

Chainflex® 1.32, 1.43

Chains

- calculation 1.5
- length
- tie-wrap plate 1.33
- turned (90 °C) 1.24 et seqq.
- unsupported 1.4

Chemical resistance: see Stability, chemical

Chips 1.37

Circular movement 1.4, 1.26 et seqq.

- "TwisterChain" 1.26
- with "RBR"
- (reverse bending radius) 1.26
- with standard E-Chain® 1.26

Clamp (Chainfix) 1.33

Classic-Series

- E-Band 12.18
- E2 medium Series 26/27/27 12.16

- E2 medium Series 200/240/250 12.4

- E2 medium Series 340/350 12.8

- E4/00 Series 38022 12.12

- E4/00 Series 383822 12.14

C-Profil 1.33

CSA 1.38

Cleanroom 1.36

Clear height 1.28

Coefficient of friction 1.18 et seqq.

Coefficient of surface friction 1.39

Cold 1.34

Colors (gumid-igus®-E-Chain®) 1.39

Combined motion 1.4

Coolant, resistance to 1.37

Corkscrewing effect 1.30

Critical sag 1.8

Crossbar 1.31

CSA 1.38

D

DESINA 1.38

Dielectric strength 1.39

Dimension units (abbreviations) 1.4

Dirt 1.37

E

E1

- Series E1.10/E1.17/E1.20 3.64

E2:**E2 micro**

- Series 03 5.10 et seqq.
- Series 04 5.14 et seqq.
- Series 045 5.18 et seqq.
- Series 05 5.22 et seqq.
- Series 06 5.26 et seqq.
- Series B07 5.30 et seqq.
- Series 08 5.34 et seqq.
- Series B09 5.38 et seqq.

E2 mini

- Series B15/B15 5.70 et seqq.
- Series B17 5.76 et seqq.
- Series F17 5.82 et seqq.
- Series 10 5.48 et seqq.
- Series 11.031 5.54 et seqq.
- Series 11.080 5.58 et seqq.
- Series 11.1/11.2 5.62 et seqq.
- Series 14 5.66 et seqq.

E2/000

- Series 255 5.138
- Series 1400/1450/1480/1500 5.92 et seqq.
- Series 2400/2450/2480/2500 5.102 et seqq.
- Series 2600/2650/2680/2700 5.114 et seqq.
- Series 3400/3450/3480/3500 5.126 et seqq.

E3/T3/E6 allgemein 8.2**E3**

- Series E3.10 8.10 et seqq.
- Series E3.15 8.14 et seqq.
- Series E3.22 8.18 et seqq.

E6

- Series E6.29 8.40 et seqq.
- Series E6.35 8.50 et seqq.
- Series E6.40 8.56 et seqq.

- Series E6.52 8.66 et seqq.

- Series E6.62 8.76 et seqq.

- Series E6.80 8.88 et seqq.

- Series E6.80L 8.82 et seqq.

- Series R6.29 8.46 et seqq.

- Series R6.40 8.61 et seqq.

- Series R6.52 8.72 et seqq.

E4:

- E4 kit 7.4

E4.1

- Series E4.21 7.16 et seqq.
- Series E4.28 7.24 et seqq.
- Series E4.32 7.34 et seqq.
- Series E4.42 7.48 et seqq.
- Series E4.56 7.62 et seqq.
- Series E4.80 7.76 et seqq.
- Series 1640 7.90 et seqq.
- Series 800 7.100 et seqq.
- Series 840 7.106 et seqq.
- Series E4.350 7.112 et seqq.

E4/light

- Series 14040 7.124 et seqq.
- Series 14240 7.134 et seqq.
- Series 15050 7.144 et seqq.

E4/00

- Series 220/R760 7.162 et seqq.
- Series 280/290/R770 7.170 et seqq.
- Series 380/390/R780 7.180 et seqq.
- Series 400/410/R880 7.190 et seqq.
- Series 600/601/R608 7.200 et seqq.
- Series 640 7.208 et seqq.

E4/4

- Series 2828/2928 7.224 et seqq.
- Series 3838/3938 7.236 et seqq.
- Series 4040/4140 7.248 et seqq.
- Series 4040HD 7.260 et seqq.
- Series 5050/5150 7.268 et seqq.
- Series 5050HD 7.280 et seqq.

E6 s. E3/T3/E6**Easy Chain® 3.0**

- Series E03 3.6 et seqq.
- Series E04 3.10 et seqq.
- Series E045/Z045 3.14 et seqq.
- Series E06/Z06 3.20 et seqq.
- Series E065 3.24 et seqq.
- Series E08/Z08 3.28 et seqq.
- Series E14/Z14 3.32 et seqq.
- Series E16/Z16 3.42 et seqq.
- Series E26/Z26 3.46 et seqq.
- Series E200/Z200 3.36 et seqq.
- Series E300/Z300 3.52 et seqq.

Easy Triflex® 2.30

- Series E322/E333 2.36

E-Tubes

- Series R48 6.26 et seqq.
- Series R58 6.34 et seqq.
- Series R68 6.42 et seqq.
- Series R117/R118 6.6 et seqq.
- Series R157/R158 6.12 et seqq.
- Series R167/R168 6.20 et seqq.
- Series FX40 6.50 et seqq.

E modulus: see Elastic modulus 1.39

E-Chain®

- coefficients of surface friction 1.18
- colors 1.39
- ESD (gumid) 1.35

- gliding application:

- inner height 1.4
- inner radius 1.4
- inner width 1.4
- link height 1.4
- material data 1.39
- medium 1.12 et seqq.
- noise optimized 1.11
- outer radius 1.4
- outer width 1.4
- projecting length 1.4
- reverse 1.17
- large 1.14 et seqq.
- small 1.12 et seqq.
- standard supply 1.27
- principle 1.17

E-Chain® pitch 1.4

E-Chain® length 1.4 et seqq.

E-Chain® separation 1.28

E-ChainSystem® 1.3, 1.6 et seqq.

- applications 1.6 et seqq.
- assembled 1.41 et seqq.
- hanging (graphic) 1.21
- ReadyChain® 1.41 et seqq.
- requirement 1.3
- standing (graphic) 1.21

Elastic modulus (E modulus) 1.39

Electric round cables 1.30

Electrostatic discharge (ESD) 1.35, 1.38

Elongation at break 1.39

Energy chain system: see E-ChainSystem®

Energy chain: see E-Chain®, etc.

ESD (Electrostatic Discharge) 1.35, 1.38

E-Tube 1.10, 1.37

F

Filling 1.28 et seqq.; s.a. 1.20 et seqq.

- bending radius R 1.4, 1.29

- regulations 1.29

- strain relief 1.31

Filling weight 1.12

Fire resistance / flammability

(gumid G, gumid NE) 1.34

Fixed end 1.5

- at the center of travel 1.17 et seqq.

Flat cable 1.31

Formulas 1.4 et seqq.

Fraunhofer Institute of Production
Technology and Automation (IPA) 1.36, 1.38

G

Gliding rail 17 et seqq.

Gliding:

- application 1.16 et seqq.
- long travels 1.16 et seqq.

Guidelock

- horizontal 9.96

- vertical 9.98

Guiding trough 1.10

Guide trough 1.18 et seqq., 1.27

- height 1.4

- width 1.4

H

Hanging application 1.20 et seqq.

Heat 1.34

Height, clearance 1.28

Hose 1.20, 1.22, 1.25, 1.28 et seq.
 - bending radius R 1.29
 - general rules in E-Chain® 1.28
 - hydraulics 1.31
 - pneumatics 1.31

Hydraulic hose 1.31

I

IF Design Award 1.38

igumid 1.38 et seq.
 - colors 1.39
 - ESD 1.35, 1.39
 - G 1.34, 1.39
 - NB 1.34, 1.39
 - special solution 1.39
 - TE 1.39

Impact strength 1.39

Installation
 - "zigzag" 1.21
 - circular movement 1.26 et seq.
 - hanging 1.20 et seq.
 - height, nominal (H) 1.5
 - height, required (HF) 1.5
 - space 1.3, 1.13
 - standing 1.22 et seq.
 - turned (90° C) 1.24 et seq.
 - type 1.5
 - vertical hanging 1.20

Installation height, required 1.5

Interbus 1.38

Interior separation (shelving) 1.29

IPA 1.34, 1.38

ISO 9001 1.38

L

Laboratory 1.3, 1.42

Lateral acceleration 1.11 et seq.

Lateral expansion 1.31

LBT-Flizz® 9.100

LeviChain 9.112

Load, alternation of 1.15, 1.29

Load-bearing surface 1.10

Load chart 1.12 et seq.

Lower run 1.17

M

Material data 1.39

Maximum additional load 1.4, 1.24, 1.25 (graphic)

Measured values, background noise corrected 1.11

Modular design 1.21

Motion, combined 1.4

Mounting bracket 1.8 et seq.
 - for gliding application 1.17
 - for unsupported applications 1.10
 - rigid 1.22, 1.25
 - vertical standing 1.22 et seq.

Moving end, reduced 1.17

Multiband chain 1.7

N

Noise level 1.11

Noise optimized chain 1.11

Nominal installation height 1.5

P

P4 9.78

Particle abrasion 1.36

Physikalisch-Technische Bundesanstalt (PTB), (Federal Physical and Technical Institute of Germany) 1.35

Pictograms 1.4

Planning 1.16, 1.21, 1.43

Plastic gliding rail 1.18

PMA 11.1

PMAFIX 11.8

PMAFLEX 11.4

Pneumatic hose 1.31

Pretension (camber) 1.5
 - hanging application 1.20

Projecting length 1.4, 1.10, 1.17

PTB (Physikalisch-Technische Bundesanstalt) (Federal Physical and Technical Institute of Germany) 1.35

R

Radiation resistance 1.34

RAL numbers 1.39

RBR (reverse bending radius) 1.26
 - order example 1.27

ReadyChain® 1.41 et seq.

Reduced moving end 1.17

Reverse bending radius: 1.4, 1.26, 1.29

Reverse chain 1.17

RoI E-Chain® 9.86, 1.16

Rollclip 1.31

Roller energy chain 1.16

Rotation angle 1.4

Round cables, electric 1.30

S

Sag, critical 1.8

Service life 1.10, 1.19

Shelf 1.29

Side-mounted application 1.24

Space reserve 1.28 et seq.

Spacers 1.25

SnapChain
 - Series TE14/TZ14/TE26/TZ26 3.68

Stability classes 1.40

Stability, chemical 1.40
 - of igumid G 1.37

Standards 1.38

Standing installation 1.22

Straight (FLG) 1.8, 1.10, 1.12

Strain
 - push-pull forces 1.34
 - relief 1.32
 - relief separator 1.33
 - tensile test 1.39

Stroke height 1.11 et seq., 1.21 et seq.

Support (without) 1.4, 1.10, 1.22

Support 1.10

Support Tray 1.10, 9.70

T

T3
 - Series T3.29 8.28 et seq.

Technical data:
 - vertical hanging 1.20
 - vertical standing 1.22

Technical environment 1.34 et seq.
 - ATEX 1.35, 1.38
 - Cleanroom and ESD 1.36
 - igumid ESD 1.35 et seq.
 - igumid G 1.34
 - igumid NB 1.34
 - IPA 1.36, 1.38
 - particle abrasion 1.36
 - PTB (Physikalisch-Technische Bundesanstalt), 1.35

Test laboratory; see Laboratory

Thermal conductivity 1.39

Tiewrap plate 1.33

Travel 1.12 et seq.
 - (long travels) 1.16 et seq.
 - general data
 - gliding 1.16 et seq.
 - half 1.4
 - long 1.16 et seq.
 - short 1.8 et seq.

Travel frequency 1.8

Travel speed 1.4, 1.8, 1.15

Triflex® 2.42 et seq.
 - Series 332/333/352/353 2.48

Triflex® R 2.4 et seq.
 - Designing / Filling 2.26
 - Installation service 2.28
 - Series TFC 2.12
 - Series TRE 2.14
 - Series TRL 2.16
 - Accessories 2.18
 - Universal module 2.22
 - Accessories 2.24

TUV 1.38

TwisterChain® 1.26

U

UL class 1.38

Unsupported 1.8 et seq.
 - definition 1.8
 - length 1.8 et seq.
 - noise optimized 1.11
 - short travels 1.8 et seq.
 - straight FLG 1.8, 1.10, 1.12
 - with bend FLB 1.8, 1.13, 1.15

Unsupported applications 1.8 et seq.

Unsupported length, definition 1.8

Upper run 1.12 et seq., 1.17

V

Vacuum 1.34, 1.37

VDE 1.38

Vertical hanging 1.20 et seq.

Vertical standing 1.22 et seq.

W

Wear 1.18

Weathering 1.34

Y

Yield stress 1.39

Z

Zigzag (motion) 1.21

Zipper 4.0 et seq.
 - E-Tube R07 4.28 et seq.

- E-Tube R09 4.32 et seq.
 - E-Tube R15 4.36 et seq.
 - E-Tube R17 4.42 et seq.
 - Series 07 4.10 et seq.
 - Series 09 4.14 et seq.
 - Series 15 4.18 et seq.
 - IPA 1.36, 1.38
 - particle abrasion 1.36
 - PTB (Physikalisch-Technische Bundesanstalt), 1.35

Selection guide | Designing E-Chains®

1

Dimensioning E-Chains®

Determine the size of the E-Chain® based on the specified installation space of your machine and/or of the selected filling (such as the number of cables/outer diameter of cable).

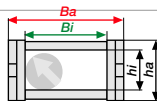

2

Determine fill weight

Determine fill weight of (cables and/or media hoses) in [kg/m] using Chainflex® Quick Selector or manufacturer specification.

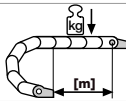

3

Determine length of travel

Compare the fill weight calculated in (point 2) to the maximum fill weight of the selected E-Chain® and check suitability for "unsupported application".

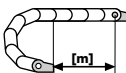

4

Unsupported length

The maximum unsupported length initially depends on the fill weight and the E-Chain® selected. At the same time, there are three different levels of unsupported length: 1 **FL_G - Recommended Range of Application** 2 **FL_B - Permitted Sag** 3 **Critical Sag: Should never be operative installation!** Twice the value of the unsupported length determines the maximum travel in the "unsupported" type of operation. For evaluation the weight of the cables to be carried must be known, then an exact evaluation can be made using a diagram on the introductory page of the selected product. You will find the values for **FL_G** and **FL_B** in table form on the following pages of this chapter and for each Series in the catalog. They are necessary for: ● Finding the fill weight and length of travel for the appropriate E-Chain® ● Identifying the maximum load of the E-Chain® used.

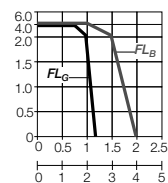
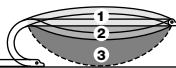

5

If there is suitability for "unsupported straight", then the selection follows the following criteria:

Opening Principle - The quick selection gives you an overview of the type of offiling potential of the E-Chain®.



6

Determine the possible **Bending Radius R** [mm] of the E-Chain® with respect to the cable diameter.

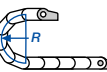

7

Interior separation is possible with...

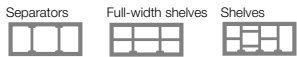

8

The **price index** gives you the possibility of making price comparisons of similar sizes within the igus® range



9

Additional criteria - for the appropriate selection of your E-Chains® such as pitch, permissible temperatures etc. are available under quick selection.

A

The following options are available if there is no possibility of self-supporting E-Chain® application:

You can choose the next and more stable E-Chain®, that can be operated "unsupported".

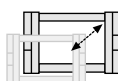

B

You can design your application to be "gliding".

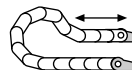

You can contact us directly or fax us your E-Chain® requests! We will respond immediately!

E-Chain® Part No: _____

Alternative E-Chain®-dimensions:

hi: _____ Bi: _____ ha: _____ Ba: _____

Fill weight: _____ kg/m

Length of travel: _____ m

Your Phone: _____

Your Fax: _____

Phone (+49) 0 22 03 - 96 49-0

Fax (+49) 0 22 03 - 96 49-222

Internet ► www.igus.de/en/finder????????

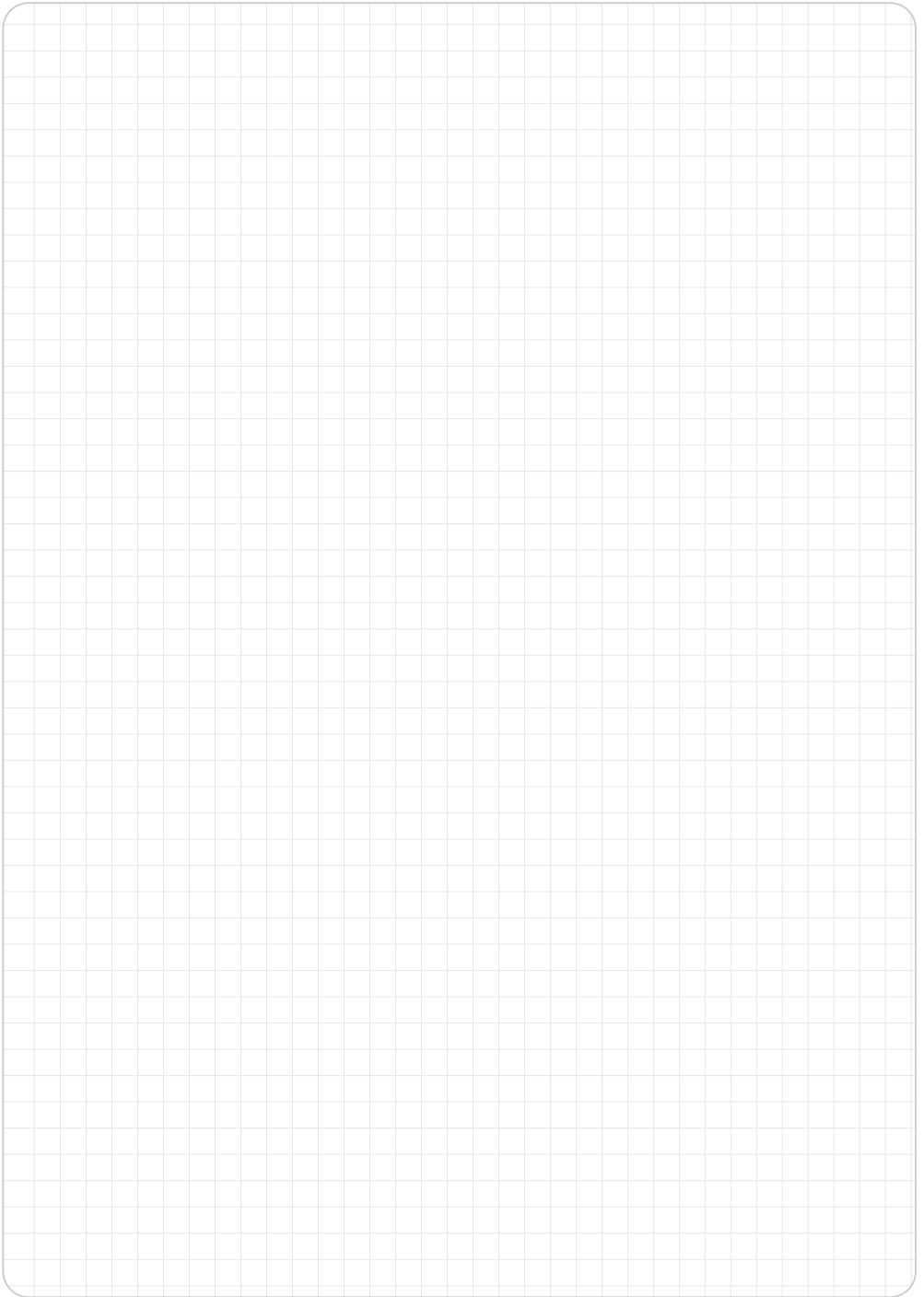

igus® worldwide

igus® offices

igus® distributors

1 Germany

igus® GmbH
Spicher Str. 1a
51147 Köln (Porz-Lind)
Postfach 90 61 23
51127 Köln
Phone +49-2203-9649-0
Fax +49-2203-9649-222
info@igus.de
www.igus.de

2 Australia

Treotham Automation Pty. Ltd.
Unit 36, 9 Powells Road,
Brookvale NSW 2100
Phone +61-2-9907 1788
Fax +61-2-9907 1778
info@treotham.com.au

3 Austria

**igus® Polymer
Innovationen GmbH**
Ort 55
4843 Ampflwang
Phone +43-76-75-4005-0
Fax +43-76-75-3203
igus-austria@igus.at

4 Argentina

FABRIMATICA S.A.
Av. Varela 2966 C.P.
1437 Buenos Aires
Phone +54-11-4918 0009
Fax +54-11-4919 0080
ventas@fabrimatica.com

5 Belarus

STS Stromtehsevis
19-009, Ul. Sharangovicha
Minsk, 220018
Phone +375 17 313-4513
Fax +375 17 313-4514
common@strom-ts.com

6 Belgium

igus® B.V.B.A.
Kolonel Begaultlaan 75
3012 Wilsede
Phone +32-16-314431
Fax +32-16-314439
info@igus.be

7 Brazil

igus® do Brasil Ltda.
Av. Eng. Alberto de Zagotts 655
Santo Amaro
04675-085 São Paulo - SP
Phone +55-11-3531 4487
Fax +55-11-3531 4488
ventas@igus.com.br

8 Bulgaria

Atlas Technic EOOD
BG-1612 Sofia
PK 51
Phone +359-895-23 25 95
Fax +359-897-98 16 69
Phone/Fax +359-2-859 76 81
a.popoff@techno-link.com

8 Bulgaria

Hennlich OOD, BG
4000 Plovdiv
Konstantin Velichkov, 69, Et. 3
Phone +359-32-511 326
Phone/Fax +359-32-621 929
office@hennlich.bg

9 Canada

igus® Office Canada
201 Millway Ave.
UNIT 25
Concord
Ontario L4K 5K8
Phone +1-905-760 84 48
Fax +1-905-760 86 88
webmaster@igus.com

10 Chile

Vendortec
San Martin # 2097
Maipú - Santiago
Phone +56-2-710 58 25
ventas@vendortec.cl

11 China

igus® Shanghai Co., Ltd.
No. 28, Jialai Road,
Waigaoqiao Free Trade Zone
Shanghai 200131, P.R.C.
Phone +86-21-51 30 31 00
Fax +86-21-51 30 32 00
master@igus.com.cn

11 China South

igus® China Guangzhou office
Room 2306, West Tower,
Yangcheng International
Commercial Center, Tiyu, East
Road,
Guangzhou 510620, P.R.C.
Phone +86-20-38 87 17 26
Fax +86-20-38 87 17 68
guangzhou@igus.com.cn

12 Croatia

Hennlich, Industrijska d.o.o.
Franje Volfila 4
10000 Zagreb
Phone +385-1-387 43 34
Fax +385-1-387 43 36
hennlich@hennlich.hr

13 Czech Republic

Hennlich Industrietechnik spol. s r.o.
o.z. Lin-tech
Čestkoijská 9
41201 Litoměřice
Phone Chains +420-416-71 13 32
Phone Bearings +420-416-71 13 39
Fax +420-416-71 19 99
lin-tech@hennlich.cz

14 Denmark

igus® ApS
Postboks 243
8800 Viborg
Phone +45-86-60 33 73
Fax +45-86-60 32 73
info@igus.dk

14 Denmark – E-Chains®

Solar AS
Industrivej Vest 43
6600 Vejen
Phone +45-76-96 12 00
Fax +45-76-36 47 59
solar@solar.dk

14 Denmark

OEM Automatic A/S
Møllehaven 8
4040 Jyllinge
Phone +45-70 27 05 27
Fax +45-70 27 08 27
info@dk.oem.se

15 Egypt

Fedicom Trading Fayed Sami & Co.
12, El Mahaad El Swissi St.,
Flat 10 – 2nd Floor-Zamalek
Cairo – A.R of Egypt
Phone +202-2736 25 37
Fax +202-2736 31 96
mohamed.layed@fedicom.com

15 Egypt

IEE International Company for Electrical Engineering
2nd floor, 25 Orabi St.
Down Town, Cairo,
Phone +202-25 76 73 70
Fax +202-25 76 73 75
anas@ee-egypt.com

16 Finland

SKS Mekaniikka Oy
Martinkyläntie 50
01720 Vantaa
Phone +358-20-764 65 22
Fax +358-20-764 68 24
mekaniikka@sk.fi

16 Finland – Chainflex®

SKS Automaatio Oy
Martinkyläntie 50
01720 Vantaa
Phone +358-20-764 67 48
Fax +358-20-764 68 20
automaatio@sk.fi

17 France

igus® SARL
49, avenue des Pépinières
Parc Médicus
94832 Fresnes Cedex
Phone +33-1-49 84 04 04
Fax +33-1-49 84 03 94
info@igus.fr

18 Greece – E-Chains®

Chrimotor s.a.
71, Sp. Patasi str.
118 55 Athens
Phone +30-210-3425574
Fax +30-210-3425595
info@chrimotor.gr

18 Greece – Bearings

J. & E. Papadopoulos S.A.
23, Retsina Street
185 45 Piraeus
Phone +30-210-4113133
Fax +30-210-4116781
sales@papadopoulos-sa.com

19 Hong Kong

Sky Top Enterprises Ltd
Phone 1707, Block C, Wah Tat
Ind Centre, Wah Sing Street,
Kwai Chung; Hong Kong
Phone +852-2243 42 78
Fax +852-2243 42 79
skytopy@ctimail.com

20 Hungary

igus® Hungária Kft.
Mogyoródi u.32.
1149 Budapest
Phone +36-1-436 64 86
Fax +36-1-431-03 74
info@igus.hu

20 Hungary

Tech-Con Kft.
Vész utca 9-11
1133 Budapest
Phone +36-1-412 41 61
Fax +36-1-412 41 71
tech-con@tech-con.hu

21 India

igus® (India) Pvt. Ltd.
199/1, 22nd Main,
HSR Layout, Agara Post,
Bangalore - 560 102
Phone +91-80-39 12 78 00
Fax +91-80-39 12 78 02
info@igus.in

22 Indonesia

PT. Energi Canggih Indonesia
Kelapa Gading Selatan
BJ 08 / 14
Gading Serpong
Tangerang 15810
Phone +62-21-547 43 64
Fax +62-21-547 43 65
jakarta@energicanggih.com

23 Iran

Tameen Entiajat Fani Tehran (TAF CO.)
72, Iranshar Ave., Unit 5
15818 Tehran, Iran
Phone +98-21-8831 78 51
Fax +98-21-8882 02 68
info@taf-co.com

24 Ireland

igus® Ireland
Fitzwilliam Business Centre
26 Upper Pembroke Street
Dublin 2
Phone +353 1 6373921
Fax +353 1 6620365
sales@igus.ie

25 Israel

Conlog LTD
P.O. Box 35 71
Petach Tikva 49134
Phone +972-3-926 95 95
Fax +972-3-923 33 67
conlog@conlog.co.il

26 Italy

igus® S.r.l.
Via de' Provvedine, 4
23899 Robbiate (LC)
Phone +39-039 5906.1
Fax +39-039 5906.222
igusitalia@igus.it

27 Japan

igus® k.k.
Arcacentral 7F, 1-2-1 Kinshi,
Sumida-ku Tokyo JAPAN
Zip 130-0013
Phone +81 3 58 19 20 30
Fax +81 3 58 19 20 55
office@inpap.jp

28 Latvia

INPAP
Katrinās Str. 16
1045 Rīga
Phone +371-750 94 04
Fax +371-750 94 03
office@inpap.lv

29 Lebanon

Mecanix Shops
Gebran Safi
Charles Helou Avenue
Beirut
Phone +961 1 486 701
Fax +961 1 490 929
mecanix@dm.net.lb

30 Lithuania

Hitech UAB
Terminalo g. 3
54469 Biruliskiu k.
Kauno raj.
Phone +370 37 323271
Fax +370 37 203273
info@hitech.lt

31 Malaysia

igus® Malaysia Sdn Bhd
No. 19-1, Jalan Pujari 1/3F
Sunway Mas Commercial Centre
47301 Petaling Jaya
Selangor D. E.
Phone +603-7880 5475
Fax +603-7880 5479
avong@igus.de

31 Malaysia

Automation Industry & Systems (M) SDN.BHD.
50, Lorong Nagasari 11,
Taman Nagasari
13600 Prai, Penang
Phone +60-4-390 56 07
Fax +60-4-399 73 27
autoind@po.jaring.my

32 Mexico

igus® México S. de R.L. de C.V.
Av. Tecnológico 496 Nte
Col. Agrícola-Bellavista
52149 Toluca
Phone +52-722-27 14 273
Fax +52-722-27 14 274
fmarquez@igus.com

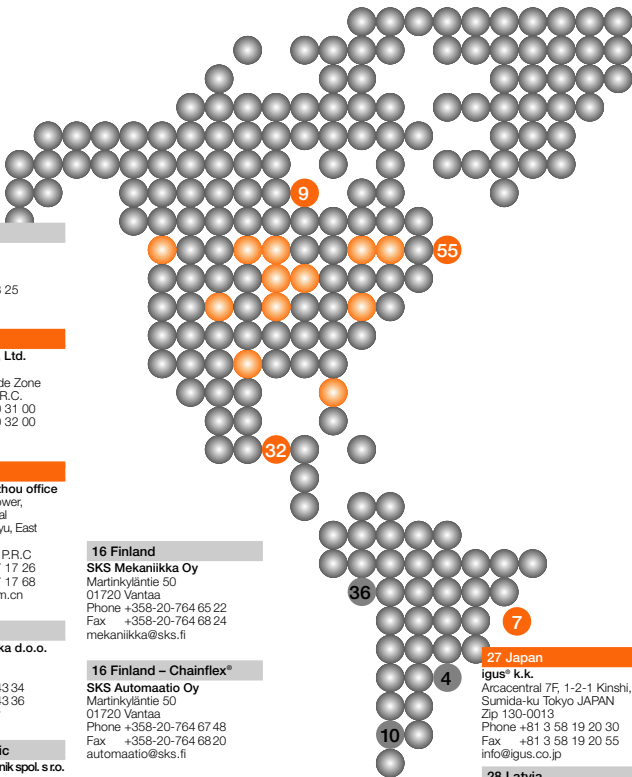



33 Netherlands

igus* Nederland
 Sterrenbergweg 9
 3769 BS Soesterberg
 Phone +31-346-353932
 Fax +31-346-353849
 igus.nl@igus.de

33 Netherlands – Bearings

Elcee Holland BV
 Kamerlingh Onnesweg 28
 NL-3316 GL Dordrecht
 Phone +31-78-6544777
 Fax +31-78-6544733
 info@elcee.nl

34 New Zealand

Automation Equipment Ltd.
 P.O. Box 5656 Frankton
 45 Colombo Street
 Frankton, Hamilton
 Phone +64-7-8472080
 Fax +64-7-8477162
 sales@autoequip.co.nz

35 Norway / Iceland

ASI Automatik AS
 Ingv. Ludvigsgensgate 23
 3007 Drammen
 Phone +47-32-829290
 Fax +47-32-829298
 info@asiautomatik.no

36 Peru

Profaco
 Av. República de Panamá N°
 4130 - Surquillo
 Lima - Perú
 Phone +51-1-2414370
 Fax +51-1-2425295
 Fax +51-1-2428608
 ventas@profaco.com

37 Poland

igus* Sp zo.o
 ul. Parowcowa 10 b
 02-445 Warszawa
 Phone +48-22-8635770
 Fax +48-22-8636169
 info@igus.pl

38 Portugal

igus* Lda.
 R. Eng. Ezequiel Campos, 239
 4100-231 Porto
 Phone +351-22-6109000
 Fax +351-22-8328321
 info@igus.pt

39 Romania

TechCon Industry SRL
 Calea Crangasi nr. 60
 060346 Bucuresti
 Phone +40-21-2219-640
 Fax +40-21-2219-766
 automatizari@metec.ro

39 Romania

Hennlich SRL
 Str. Patria, Nr17
 310106 Arad
 Phone +40-257-21119
 Fax +40-257-21021
 igus@hennlich.ro

40 Russia

Eka-Service Kompani
 1-aja Dubrowskaja, 2A, k. 35
 109044 Moskau
 Phone +7-495-6326623
 Fax +7-495-6771778
 info@ekaservice.ru

40 Russia

Barti OOO
 194358 St. Petersburg
 Phone +7-812-9724914
 Fax +7-812-4483828
 barti@barti.ru

41 Serbia

Hennlich doo Beograd
 Ul. S. Markovica 3/4
 11400 Mladenovac
 Phone +381-113943414
 Fax +381-113943412
 office@hennlich.rs

42 Singapore – HO ASEAN

igus* Singapore Pte Ltd.
 15 Shaw Road, #03-02
 Singapore 367953
 Phone +65-64871411
 Fax +65-64871511
 Malaysia-Hotline +60-12-7093041
 Thailand-Hotline +66-9-1607369
 asia-sales@igus.de

43 Slovakia

Hennlich Industrietechnik s.r.o.
 Kosická 52
 821 08 Bratislava
 Phone +421-2-50204308
 Fax +421-2-50204311
 technik@hennlich.sk

44 Slovenia

Hennlich, d.o.o.
 Industrijska tehnika
 Podnart 33
 SI-4244 Podnart
 Phone +386-4-5320610
 Fax +386-4-5320620
 info@hennlich.si

45 South Africa

igus* Pty. Ltd.
 Unit 14, Heron Park
 80 Corobrik Road
 PO Box 4214
 4017 Riverhorse Valley
 Phone +27-31-5696633
 Fax +27-31-5696636
 sales@igus.co.za

46 South Korea

igus* Korea Co. Ltd.
 255L 13LT Namdong Ind. Complex
 446-11 Nonhyun-dong, Namdonggu
 Incheon City, 405-300
 Phone +82-32-8212911
 Fax +82-32-8212913
 sales-korea@igus.de

47 Spain

igus* S.L.
 C/ Libobatonra, 6
 Poligono Noi del Sucre
 08840 Viladecans - Barcelona
 Phone +34-93-6473950
 Fax +34-93-6473951
 igus.es@igus.es

48 Sweden

igus* ab
 Knut Pälss väg 8
 256 09 Helsingborg
 Phone +46-42-329270
 Fax +46-42-211585
 info@igusab.se

48 Sweden – E-Chains*

OEM Automatic AB
 Box 1011 Dalagatan 4
 573 28 Tranås
 Phone +46-75-2424100
 Fax +46-75-2424159
 info@aut.oem.se

48 Sweden – Bearings

**incl. DryLin*
 Coily Components AB**
 P.O. Box 76
 164 94 Kista
 Phone +46-8-7030100
 Fax +46-8-7039841
 info@me.coily.se

49 Switzerland

igus* Schweiz GmbH
 Industriest. 11
 4623 Neuendorf
 Phone +41-62-3889797
 Fax +41-62-3889799
 info.ch@igus.ch

50 Taiwan

igus* Taiwan Company Limited
 2F, No 82, 32nd Road
 Taichung Industrial Park
 40768 Taichung
 Phone +886-4-2358-1000
 Fax +886-4-2358-1100
 igus-taiwan@igus.com.tw

51 Thailand

Autoflexible Engineering Co., Ltd.
 111 Sol. Sukhumvit, 62/1
 Bangjak, Phakanong
 Bangkok 10260
 Phone +66-2-3112111
 Fax +66-2-3327900
 kwancha@autoflexible.com

52 Turkey

HIDREL Hidrolik Elemanlar
 Sanayi ve Ticaret A.S.
 Percemli Sk. No. 7
 Tünel Mevki
 80000 Karaköy / Istanbul
 Phone +90-212-2494881
 Fax +90-212-2920850
 info@hidrel.com.tr

53 United Kingdom

igus* UK Ltd.
 51A Caswell Road
 Brackmills
 Northampton NN4 7PW
 Phone +44-1604-677240
 Fax Chain +44-1604-677242
 Fax Bearing +44-1604-677245
 sales_uk@igus.co.uk

54 Ukraine

Cominpro Ltd.
 Romana Rollana 12, Office 220
 61058 Kharkov
 Phone +38-0577174914
 Fax +38-0577174914
 cominpro@gmail.com

55 USA

igus* inc.
 50 N. Broadway
 P.O. Box 14349
 East Providence, RI 02914
 Phone +1-401-4382200
 Fax +1-401-4387270
 webmaster@igus.com